



Service Manual



White Outdoor ZT 17



MTD Products LLC - Product Training and Education Department

FORM NUMBER 769-01421

9/2004

For Discount White Outdoor Parts Call 606-678-9623 or 606-561-4983

TABLE OF CONTENTS

General Information	1
Deck Leveling	1
PTO/Deck Belt Replacement	2
Deck Removal	2
Blade Drive Belt Removal	2
Idler Arm Removal	2
Blade Spindle Removal	3
Drive Belt Replacement	3
Servicing Electric PTO Clutch	3
Transmission Replacement	4
Steering Linkage: Adjustment	6
Pivot Bar	9
Seat Removal	10
Console Removal	11
Battery Removal	13
Fuel Tank Removal	14
Control Shaft Replacement	15
Deck Lift Shaft Replacement	16
Electrical System Components	19
Relays	21

For Discount White Outdoor Parts Call 606-678-9623 or 606-561-4983

White Outdoor RZT 17

17AA5A4G790

1E154G20133



GENERAL INFORMATION

WELCOME to the world of RZT. 2004 is the first year for the RZT. There are two models RZT17 and RZT22.

This series of riders has the unique feature of not having to reset the PTO switch if the end users tries to mow in reverse. Once one lapbar is moved in to neutral or forward the PTO will turn back on.

The "RZT 17" has a 17 HP Briggs & Stratton Intek which is a single cylinder engine with full pressure lubrication. The engine drives the dual Hydro-gear EZT Hydrostatic transmissions and the electric PTO. The PTO runs the 3-in-1 blades on the 42" twin blade stamped deck. On the front of the stamped frame is a large pivoting front axle. All this with the 3 gallon fuel tank will provide many hours of fun and relaxing mowing.

The "RZT 22" is very similar to the RZT 17 except for the twin cylinder, 22 HP Briggs & Stratton Intek. There are also 4 wheels, instead of 2, on the 50" triple blade stamped deck.

1. DECK LEVELING

- 1.1. To adjust the deck pitch, front to back, loosen or tighten the jam nuts located on the front stabilizer bracket using a 15/16" socket and a 15/16" wrench. The correct deck pitch should be 1/8" to 1/4" lower in the front than in the back, as measured from the blade tips. See Figure 1.1.



Figure 1.1

- 1.2. To level the deck, side to side, loosen the screw on the left side adjustment gear using a 1/2" socket. Using a 3/4" wrench, run the gear up or down as necessary until each outside blade tip is the same distance from the ground. See Figure 1.2.

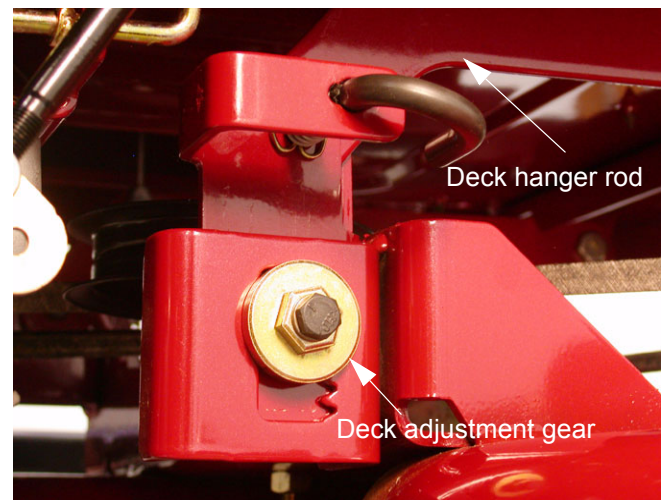

Figure 1.2

2. PTO / DECK BELT REPLACEMENT

- 2.1. Insert a 1/2" breaker bar into the square hole in the tensioner arm located on top of the deck. See Figure 2.1.

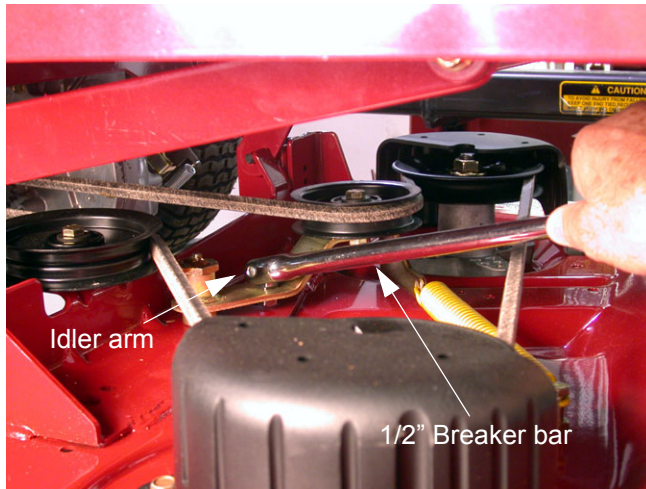

Figure 2.1

- 2.2. Pivot the tensioner arm and pulley to slacken the belt.
- 2.3. Remove the belt from the two stationary idler pulleys and spindle pulleys.
NOTE: The spindle covers do not need to be removed.
- 2.4. Remove the belt from the clutch.

3. DECK REMOVAL

- 3.1. Release the deck J pins from the rear hanger arms. See Figure 3.1.

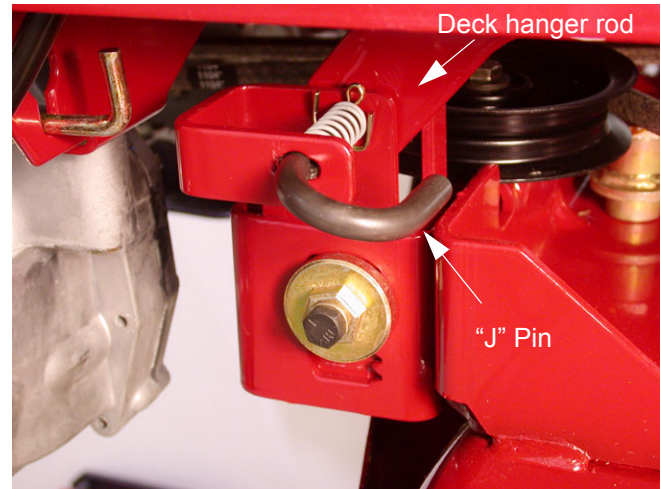

Figure 3.1

- 3.2. Slide the deck forward until the front stabilizer bar can be lifted away from the front mounting bracket.
- 3.3. Slide the deck out from underneath the unit.

4. BLADE DRIVE BELT REMOVAL

- 4.1. Remove the deck from the unit.
- 4.2. Remove both belt covers. These belt covers are identical and interchangeable. See Figure 4.2.

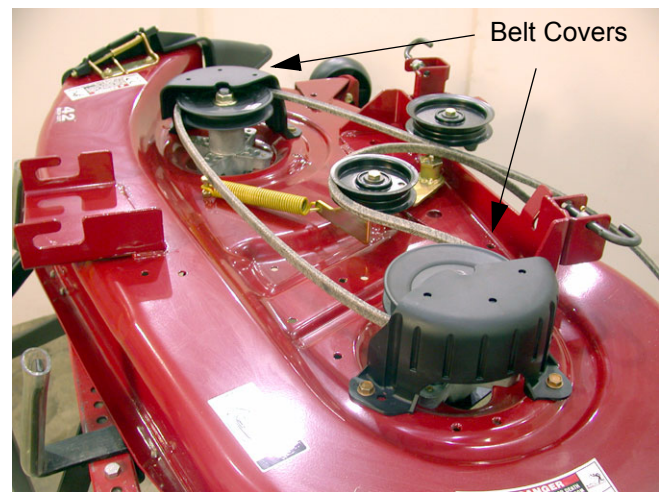

Figure 4.2

- 4.3. Remove the belt from around the pulleys.
 - 4.4. Install the new belt. A belt routing diagram label is adhered to the deck housing.
- ## 5. IDLER ARM REMOVAL

- 5.1. Remove the cutting deck from the unit.
- 5.2. Remove the shoulder screw and hex insert lock nut securing the idler to the deck housing. See Figure 5.2.

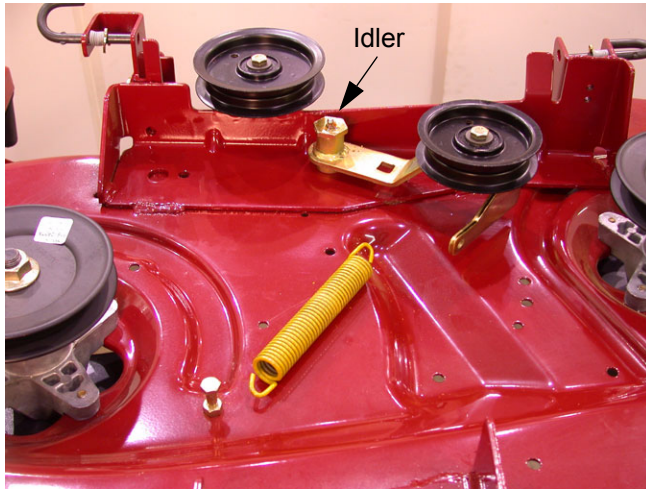

Figure 5.2

- 5.3. Remove the idler and inspect for wear or damage.
- 6. BLADE SPINDLE REMOVAL**
- 6.1. Remove the deck from the unit.
 - 6.2. Remove the spindle covers and blade drive belt.
 - 6.3. Using an impact wrench, remove the hex flange nut securing the blade to the spindle assembly. See Figure 6.3.



Figure 6.3

- 6.4. Remove the four hex washer head tapp screws securing the spindle assembly to the deck housing.
- 7. DRIVE BELT REPLACEMENT**

- 7.1. Insert a 3/8" breaker bar into the square hole on the tensioner arm.
- 7.2. Pull the breaker bar to the right until it can be braced in position at the pivot point of the tensioner arm. See Figure 7.2.

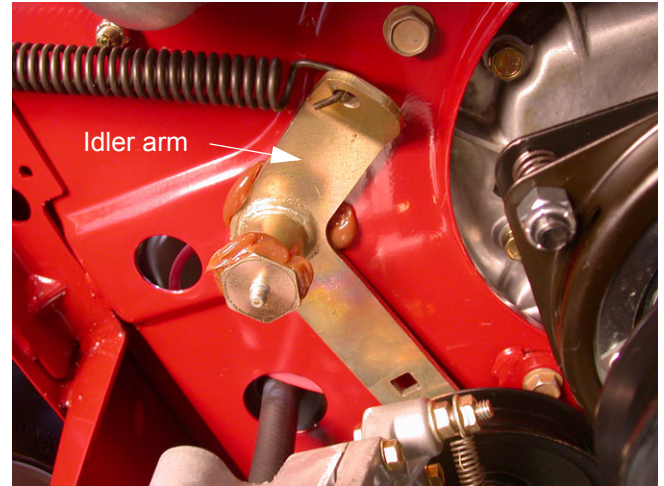

Figure 7.2

- 7.3. Remove the belt from the transmission pulleys, tensioner pulley and the crankshaft pulley. Belt is part number 754-04043
- 8. SERVICING ELECTRIC PTO CLUTCH**
- 8.1. Using a small flat blade screwdriver, unplug the electrical connector on the PTO clutch.
 - 8.2. Using a 5/8" socket and an impact wrench, remove the clutch bolt. See Figure 8.2.

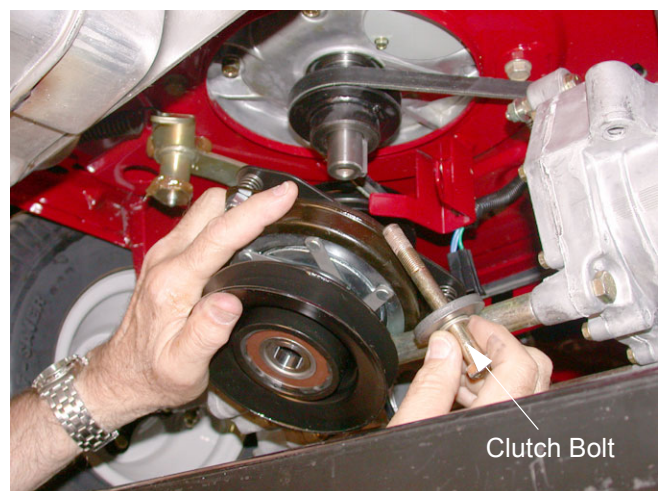

Figure 8.2

- 8.3. Lower the clutch off of the crankshaft.
- 8.4. Remove the crankshaft key.

- 8.5. Remove the crankshaft pulley. See Figure 8.5.

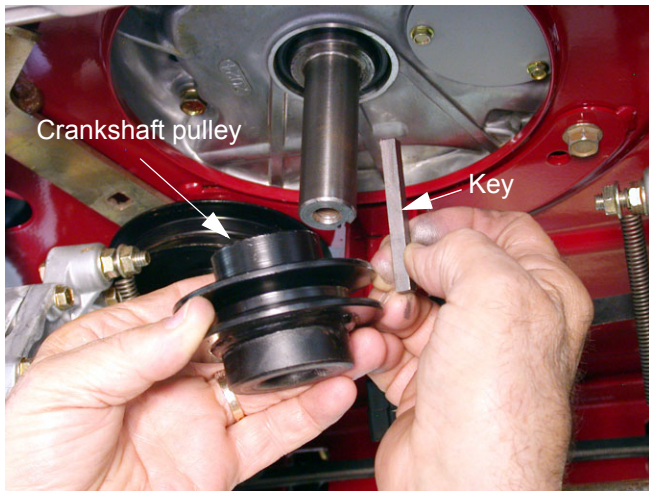

Figure 8.5

- 8.6. Use a 9/16" socket to adjust the air gap on the clutch to between .010" and .015". See Figure 8.6.



Figure 8.6

NOTE: Clutch adjustment can be done with the clutch in the unit. If a new clutch is being put in the adjustment can be done on the bench.

9. TRANSMISSION REPLACEMENT

- 9.1. Insert a 1/2" breaker bar into the square hole on the tensioner arm.
- 9.2. Pull the breaker bar to the right until it can be braced in position at the pivot point of the tensioner arm.

- 9.3. Remove the belt from the transmission pulleys, tensioner pulley and the crankshaft pulley.

- 9.4. Using a 3/4" socket, remove the four lug nuts securing the rear wheel to the axle hub.

NOTE: Insure the lap bar control rods and brake rods are not rubbing against the frame.

- 9.5. Remove the cotter pin securing the bypass rod to the transmission bypass arm. Remove the bypass rod. See Figure 9.5.

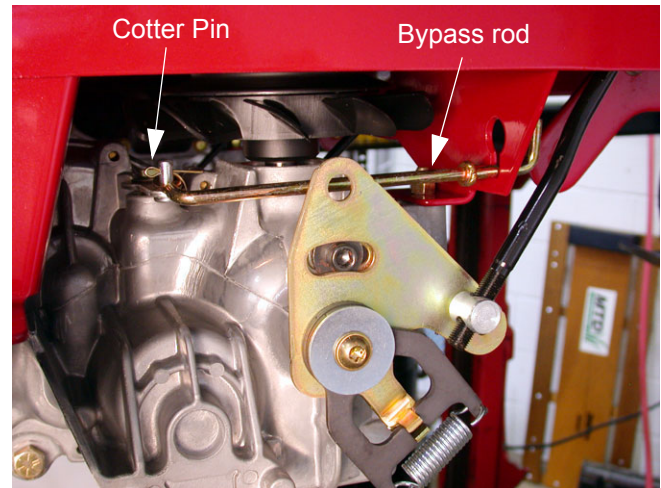

Figure 9.5

- 9.6. Mark the lap bar control rod threads near the clevis pin. See Figure 9.6.

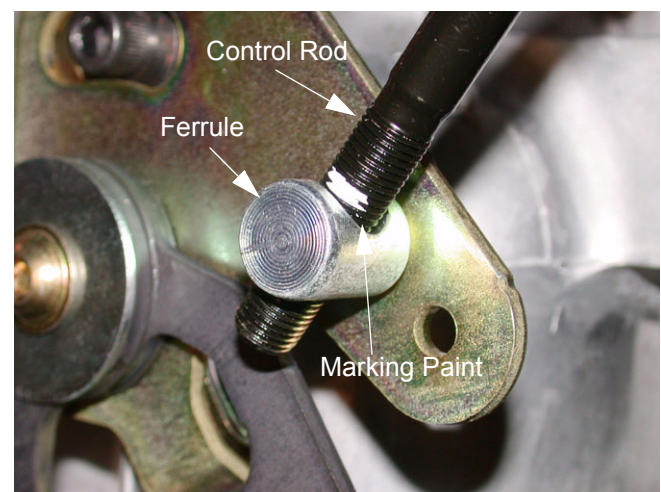

Figure 9.6

- 9.7. Remove the hairpin securing the lap bar control rod to the transmission return assembly. See Figure 9.7.

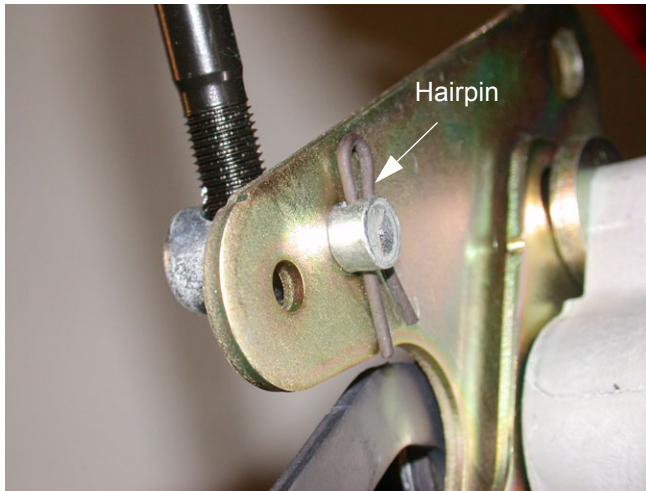

Figure 9.7

- 9.9. Remove the bolt securing the brake arm to the transmission using a 7/16" socket. See Figure 9.9.

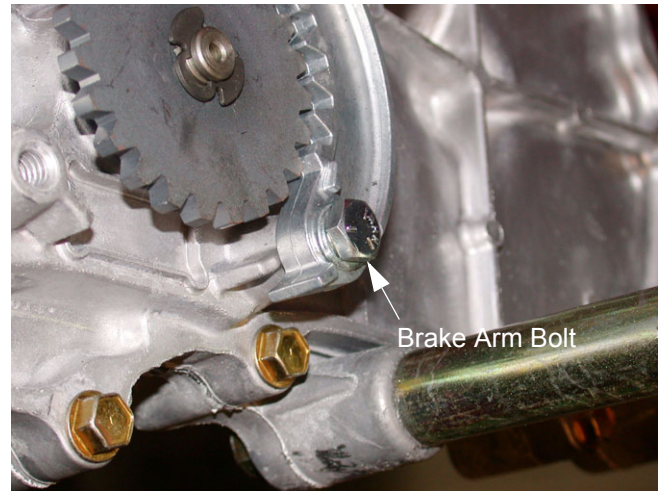

Figure 9.9

- 9.8. Disconnect the brake return spring from the brake arm. See Figure 9.8.

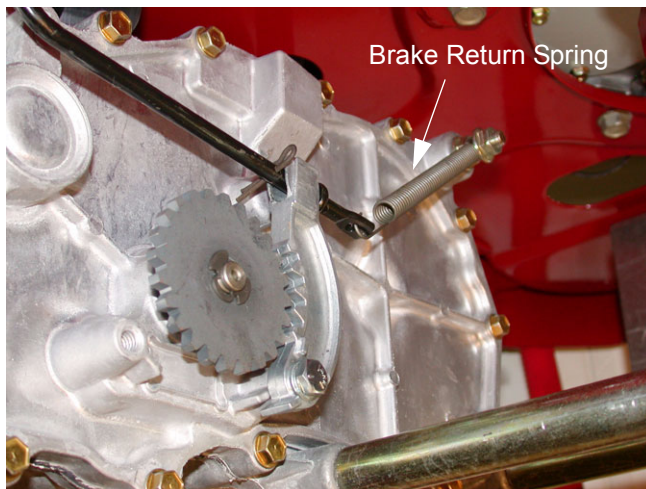

Figure 9.8

NOTE: A spacer is located between the brake arm and transmission housing.

NOTE: During installation, the bottom ridge of the brake arm needs to be below the embossment on the transmission housing. Improper installation will prevent the brake from engaging.

- 9.10. Remove both bolts securing the tubular transmission brace using a 5/8" socket.

NOTE: When installing the brace bolts use loctite 242.

- 9.11. Remove the front transmission mounting bolt using a 1/2" wrench and a 1/2" socket.

NOTE: Secure the transmission or use another technician to support the transmission while performing the next step.

- 9.12. Remove both transmission mounting bolts securing the transmission to the mounting bracket using two 1/2" wrenches. See Figure 9.12.

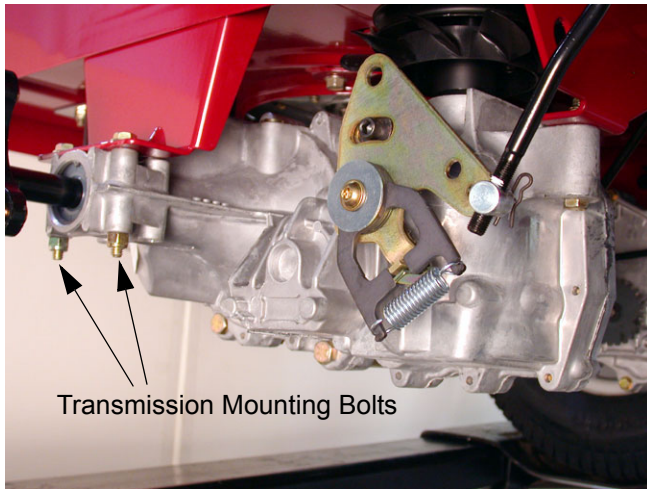

Figure 9.12

- 9.13. Rotate the transmission out and down until the fan is clear of the front transmission mounting bracket, and remove it from the frame.
- 9.14. Installation notes:
- Lift transmission into place and start all threaded fasteners before tightening any individual fasteners.
 - Install the axle horn bolts from the top down, tighten nuts to a torque of 90-120 in-lbs.
 - Install the torque bracket bolt from the bottom up, and tighten the nut to a torque of xxx in-lbs.
 - Install the bolts in the tubular transmission braces and tighten them to a torque of xxx in-lbs.
 - The remainder of the installation process consists of reversing the removal process.
 - Tighten the lug nuts to a torque of xxx in-lbs.

10. STEERING LINKAGE: ADJUSTMENT

- 10.1. Begin to adjust the steering by confirming that both EZTs are correctly adjusted for neutral control. See Figure 10.1.

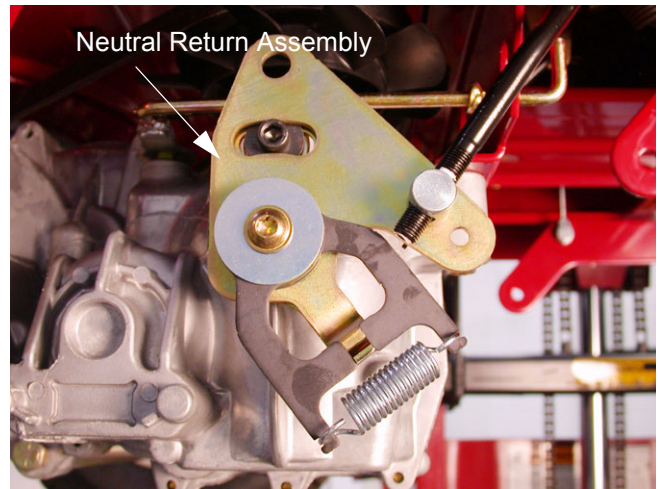

Figure 10.1

- 10.2. Lift and safely support the rear of the mower.
- 10.3. Disconnect the ferrule at the EZT end of each lap bar control rod from the neutral return assembly on each of the EZTs. The ferrules are secured to the neutral return assemblies with hairpin clips. See Figure 10.3.

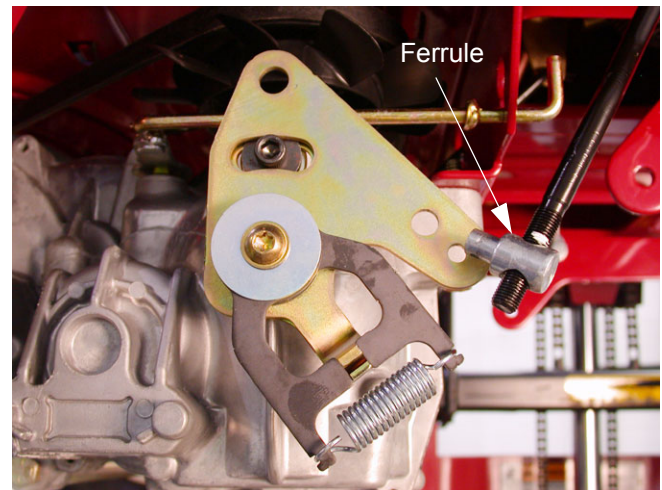

Figure 10.3

NOTE: In the course of normal service, it is very unusual for the neutral return assemblies to require adjustment unless someone has previously tampered with it. It is necessary to check the adjustment because the rest of the proce-

sure counts on the neutral control being correctly adjusted.

- 10.4. Start the engine. With the control rods disconnected, the EZT should self-center to neutral. The wheels should not rotate. If either wheel rotates, the neutral return assembly on the EZT that drives that wheel needs to be adjusted.
- 10.5. To adjust the neutral return assembly, loosen the socket head cap screw that holds the centering bracket in position on the housing using a 1/4" allen wrench. See Figure 10.5.

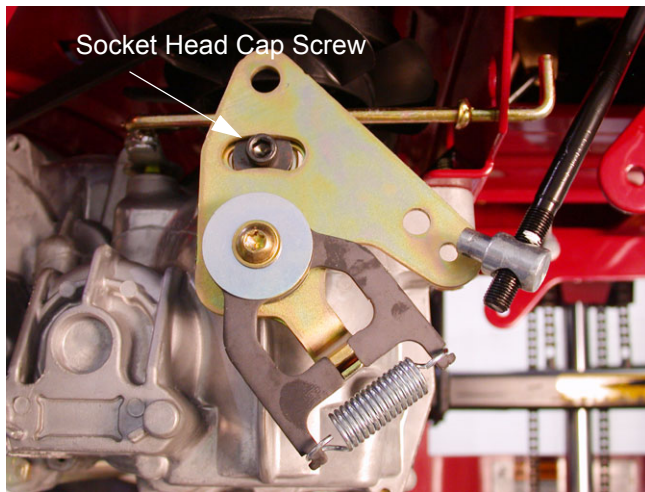

Figure 10.5

- 10.6. Rotate the assembly in whichever direction causes the wheels to stop rotating. The point where the wheels do not rotate with the engine at full throttle is true neutral. Tighten the socket head cap screw at true neutral. When making this adjustment, the transmission should be warm.

- 10.7. Align the post on the ferrule with the hole that it seats into on the neutral return assembly. Thread the ferrule up or down the length of the control rod to center the lap bar in the neutral recess in the control console. See Figure 10.7.

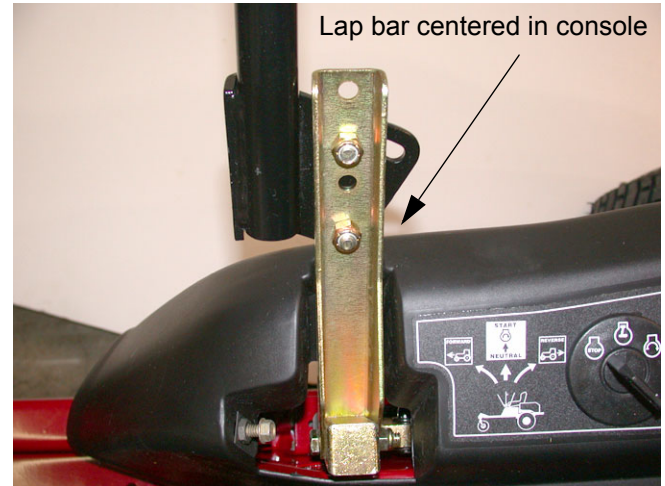

Figure 10.7

- 10.8. When each ferrule is in the correct position, secure it to the neutral control assembly with a hairpin clip.
- 10.9. Lower the machine to the ground. Test the operation of the hydros in a safe space.
- 10.10. Adjust the stop bolts so that it tracks as straight as possible with both lap bars pushed to the full forward position. See Figure 10.10.

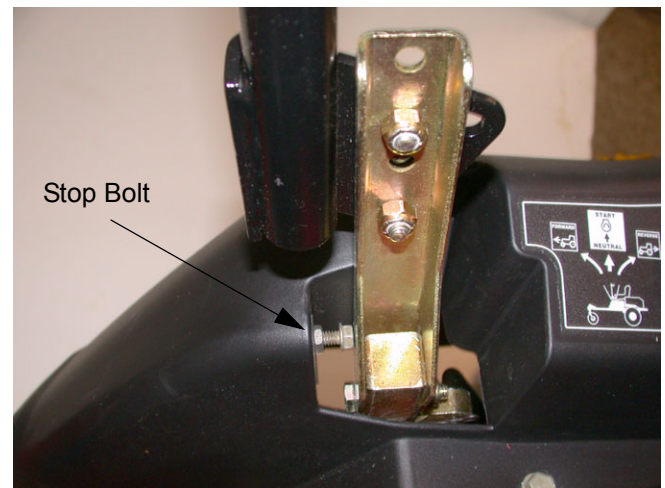

Figure 10.10

10.11. The socket head cap screws that secure the neutral return assemblies to the EZTs act as a travel stop at the EZT end of the linkage. The lap bar pivot brackets should contact the stop screws before the socket head cap screw contacts the end of the slot on the neutral bracket. See Figure 10.11.

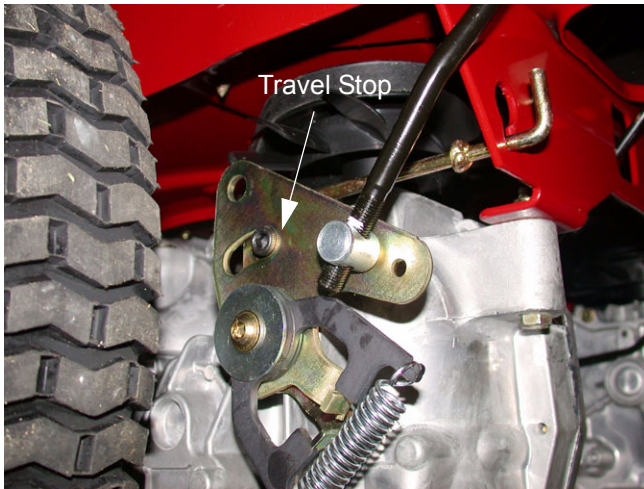

Figure 10.11

10.12. If the lap bars are not aligned with each-other, they may be adjusted using the slotted mounting where they connect to the lap bar pivot brackets. See Figure 10.12



Figure 10.12

10.13. After final adjustment, test the operation of the reverse safety switches. They should turn the

PTO clutch off whenever both lap bars are in the reverse position.

NOTE: With one lap bar in the reverse position, and the PTO turned on, the PTO clutch should turn off as soon as the second lap bar crosses the threshold from neutral into reverse. Repeat test for each side.

NOTE: When at least one lap bar is in the neutral or forward position, the PTO clutch will operate. There is not a relay to re-set by cycling the PTO switch off and on again, as is the case with Cub Cadet front engine residential equipment.

10.14. If the reverse safety switch adjustment is not correct, loosen the reverse safety switch bracket using a 3/8" wrench. Pivot the bracket and switch to a position that results in correct operation, then tighten the bracket. See Figure 10.14.

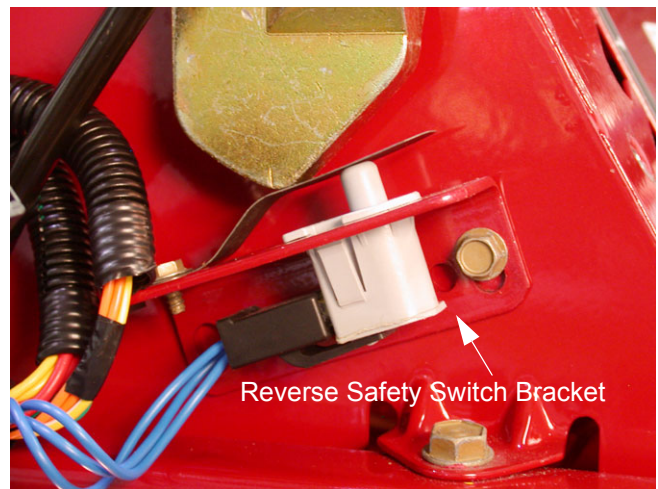

Figure 10.14

NOTE: It is not necessary to remove either control console to reach the reverse safety switches, but it may be necessary to temporarily disconnect the blue wires in order to reach the mounting screws for the brackets.

11. PIVOT BAR

- 11.1. Safely lift and support the front of unit.
- 11.2. Disconnect the - (negative) lead to the battery.
- 11.3. Using two 3/4" wrenches remove wheel assembly from caster bracket. See Figure 11.3.

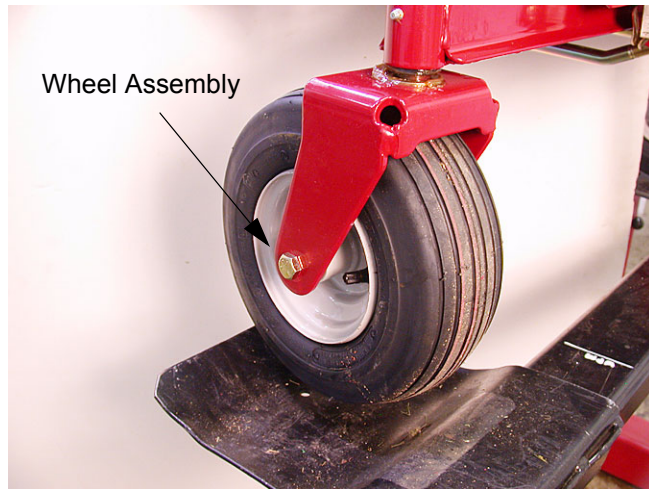

Figure 11.3

NOTE: Be careful not to drop spacers on both sides of wheel assembly.

- 11.4. Remove center wheel spacer and inspect all spacers for damage. See Figure 11.4.

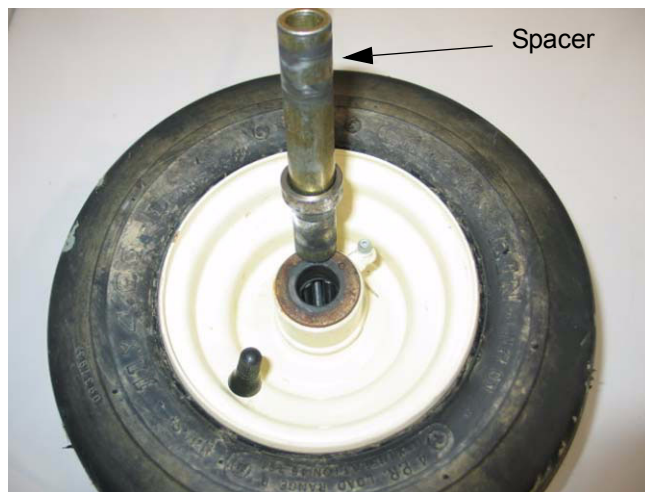

Figure 11.4

NOTE: Be sure to use a good quality grease during reassembly.

NOTE: There is a non replaceable 3/4" roller bearing in the wheel hub.

- 11.5. Lightly grease the wheel spacers during re assembly. Using a grease gun fill the rest of the cavity AFTER the wheel assembly has been mounted.
- 11.6. Remove both caster wheel assemblies using a 9/16" wrench. See Figure 11.6.



Figure 11.6

- 11.7. Inspect flange bearing on top and bottom of pivot axle. Replace if damaged. See Figure 11.7.

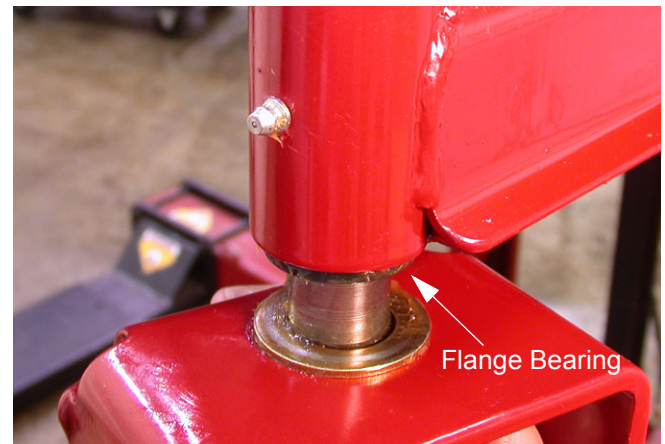

Figure 11.7

NOTE: Assure proper order during reassembly. From the top down in this order: hex head cap screw, lock washer, flat washer, flange bearing, pivot axle, flange bearing, flat washer, and caster bracket.

NOTE: Be sure to use a good quality grease during reassembly.

- 11.8. Using a grease gun, fill the rest of the cavity AFTER final assembly. Filling before final assembly will allow the flange bearings to be pushed out.
- 11.9. Remove both hex cap screws securing the axle shaft to the frame. This will be done with a 3/4" wrench. See Figure 11.9.



Figure 11.9

NOTE: Use removable threadlocking compound such as "Loctite 242" during reassembly.

- 11.10. The axle shaft may be removed and inspected for wear.
- 11.11. Inspect the flange bearing on each side of the pivot axle for wear. Replace as needed. See Figure 11.11.

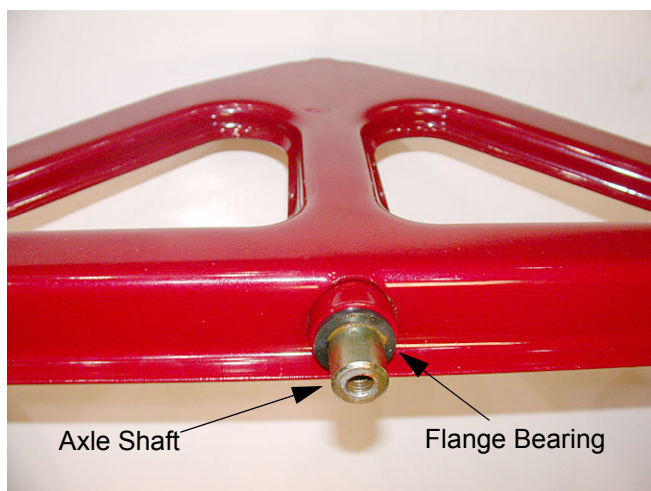

Figure 11.11

- 11.12. AFTER reassembly use a good quality grease to fill the axle shaft chamber.

12. SEAT REMOVAL

- 12.1. Disconnect the - (negative) lead to the battery.
- 12.2. Flip the seat forward. Keep one hand on back of seat to prevent seat from trying to fall back. See Figure 12.2.

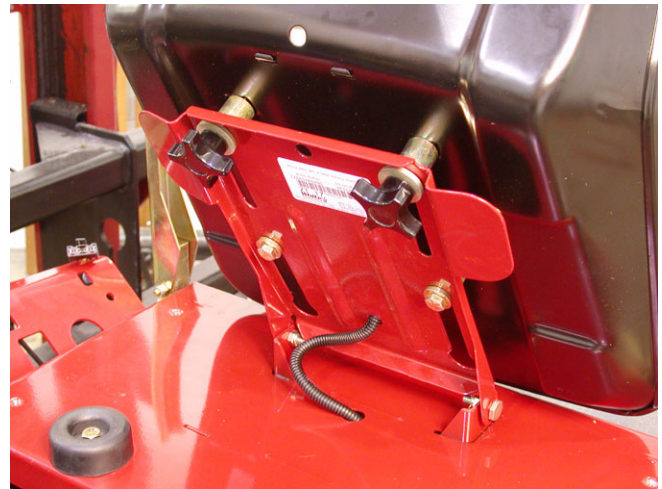

Figure 12.2

- 12.3. Remove both wing knobs from under seat. Keep track of washers and spacers. See Figure 12.3.

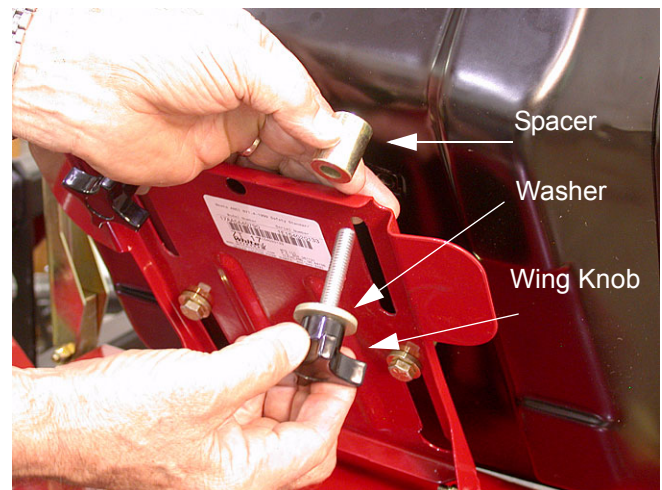

Figure 12.3

- 12.4. Slide seat forward to align seat spacers with large hole in seat mounting bracket. Carefully lift the seat out.

- 12.5. Disconnect wires from the seat safety switch.
See Figure 12.5.

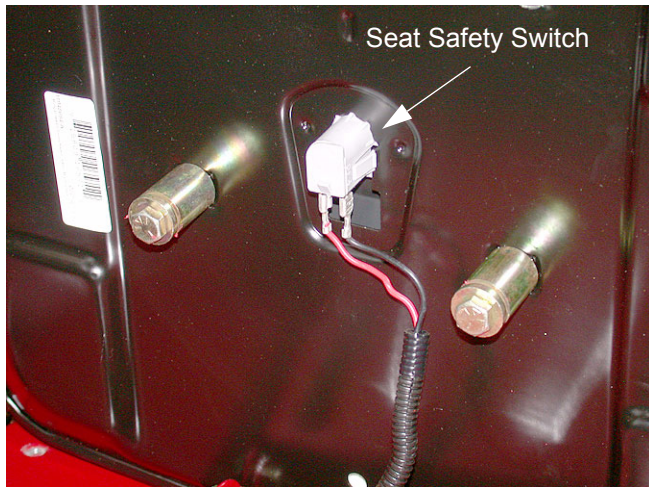

Figure 12.5

NOTE: Failure to reconnect seat safety switch will cause unit not to run.

13. CONSOLE REMOVAL

The console needs to be removed to do many of the following procedures. Removing the right and left console are very similar.

Under or attached to the left side console there is the neutral switch, starter solenoid, three relays, 20 amp fuse, choke knob (if applicable), hour meter, throttle lever and reverse safety switch.

Under or attached to the right side console there is neutral switch, key switch, reverse safety switch, and pto switch.



LEFT SIDE CONSOLE



RIGHT SIDE CONSOLE

- 13.1. Disconnect the - (negative) lead to the battery.
13.2. Using a 1/2" wrench, remove the three screws securing the console to the seat frame.
See Figure 13.2.

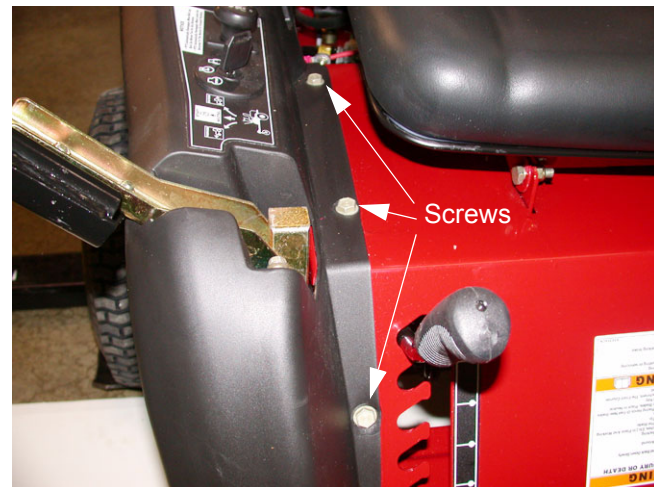

Figure 13.2

- 13.3. From underneath remove the four #12-16 self-tapping hex head screws. This can be accomplished by using a 5/16" socket with an extension.

- 13.4. There are two screws hidden in the tubular frame at the front end of the console and the rear of the console. See Figure 13.4.



Figure 13.4

- 13.6. Using a 1/2" socket and box end wrench, remove the four hex screws connecting the lap-bar levers to the pivot bracket. See Figure 13.6.



Figure 13.6

- 13.5. The two other screws are located under the console mounting bracket. See Figure 13.5.



Figure 13.5

NOTE: If the console mounting bracket is slotted, where it is attached to the seat frame box, it may be easier to loosen the mounting screws from the seat frame and leave bracket mounted to the console.

- 13.7. Remove the lapbars and set them aside.

NOTE: Before loosening the hex screws, mark their position to facilitate reassembly.

- 13.8. Carefully remove console from unit.

NOTE: Unscrew fuel cap when removing the left side console.

- 13.9. If any electrical connections are present disconnect or remove switch from console. See Figure 13.9.

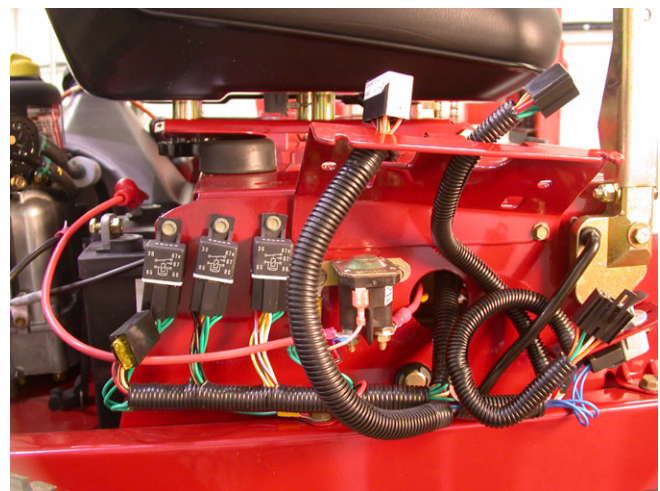

Figure 13.9

13.10. The throttle cable and choke knob does not need to be removed. The console can be flipped up on the unit and secured safely.

NOTE: There is different throttle and choke cable routing for the different models.

NOTE: Not all models have a choke knob.

14. BATTERY REMOVAL

The battery can be removed two different ways. Depending on the final out come of the work that needs to be preformed is which technique you will use.

When just replacing a battery the fuel pump needs to be removed.

If for any reason the right side control console has to be removed in conjunction with removal of the battery, the fuel pump will NOT have to be removed.

NOTE: THE FOLLOWING STEPS ARE FOR BATTERY REMOVAL WITH OUT THE REMOVING THE RIGHT SIDE CONSOLE.

- 14.1. Disconnect the - (negative) lead to the battery.
- 14.2. Disconnect the + (positive) lead to the battery.
- 14.3. Disconnect the battery strap from frame.
- 14.4. Using a 3/8" wrench remove the two screws securing the fuel pump to the engine. The hoses don't need to be removed. See Figure 14.4.

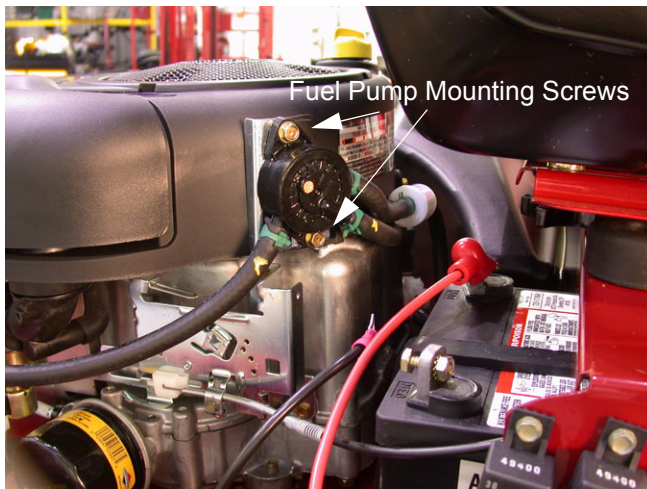

Figure 14.4

NOTE: When reinstalling the battery make sure strap is hooked under the seat box before placing battery in the unit.

14.5. Battery can be pulled up and to the side to remove.

NOTE: THE FOLLING STEPS ARE FOR BATTERY REMOVAL WITH THE REMOVAL OF THE RIGHT SIDE CONSOLE.

- 14.6. Disconnect the - (negative) lead to the battery.
- 14.7. Disconnect the + (positive) lead to the battery.
- 14.8. Disconnect the battery strap from frame.
- 14.9. Remove right side console as per "CONSOLE REMOVAL" of this manual.
- 14.10. With the right side console removed the battery will slip out the side easily. See Figure 14.10.

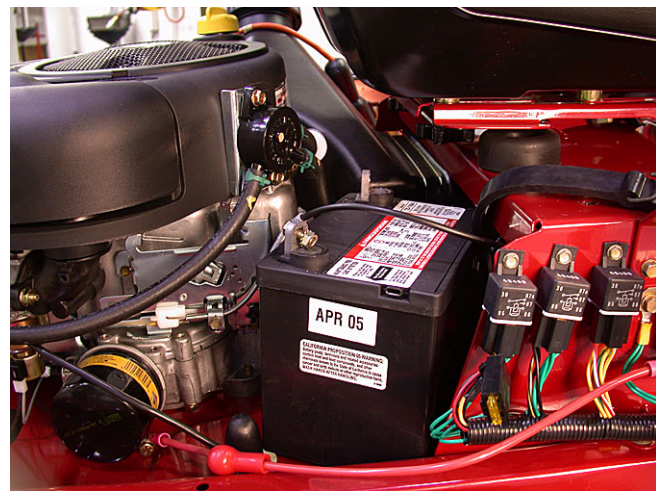

Figure 14.10

15. FUEL TANK REMOVAL

- 15.1. Perform the “SEAT REMOVAL” section of this manual.
- 15.2. Disconnect the negative battery cable from the battery.
- 15.3. Remove the two screws securing the fuel tank mounting wire to the frame using a 1/2” socket. See Figure 15.3.



Figure 15.3

- NOTE:** Removing the battery may make this procedure easier.
- 15.4. Remove fuel tank mounting wire and set off to the side.
 - 15.5. Disconnect electrical connector between the tank and the engine to allow room for the tank to slide out. See Figure 15.5.

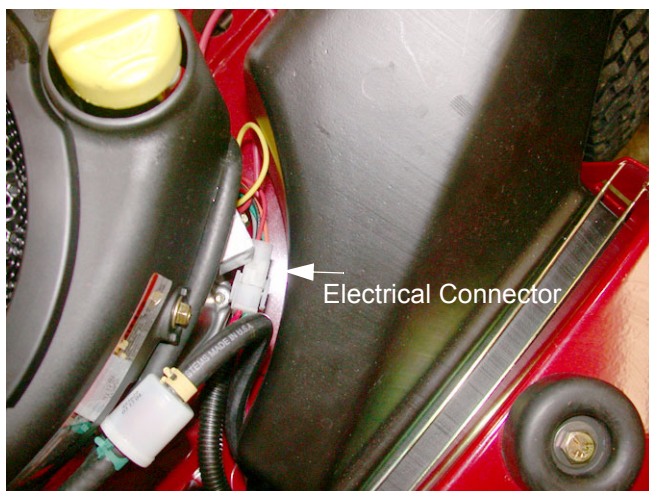

Figure 15.5

- 15.6. Remove the left console as described in the “CONSOLE REMOVAL” section of this manual.
- 15.7. Rotate tank upward and slide out toward the side. See Figure 15.7.

NOTE: If the type of engine used on the unit does not allow the removal of the fuel tank, you must loosen the seat box frame to remove the tank. Follow these steps to loosen the seat box frame.

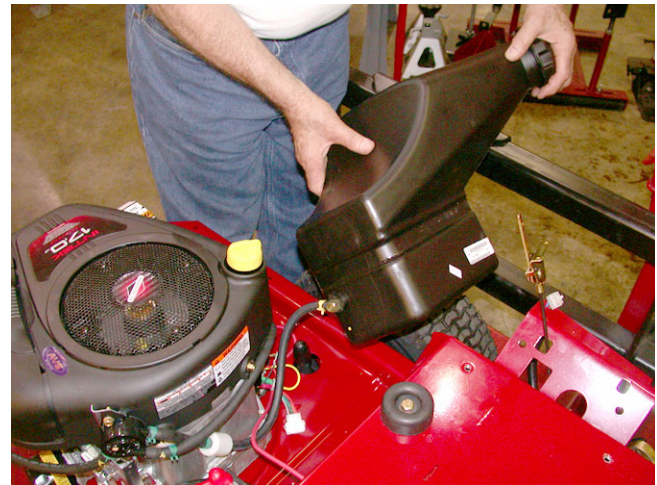

Figure 15.7

- 15.8. From under the unit, remove the hairpin clip securing the lap bar control rod to the hydro return assembly. Disconnect the ferrule from the assembly. Do this for both hydros. See Figure 15.8.

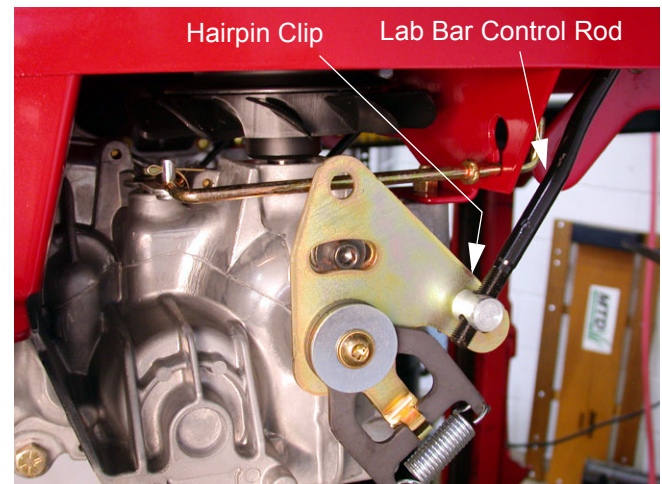

Figure 15.8

- 15.9. Remove the hairpin clip from the brake rod at the deck lift shaft. Remove the rod from the shaft bracket. Do this for both brake rods. See Figure 15.9.

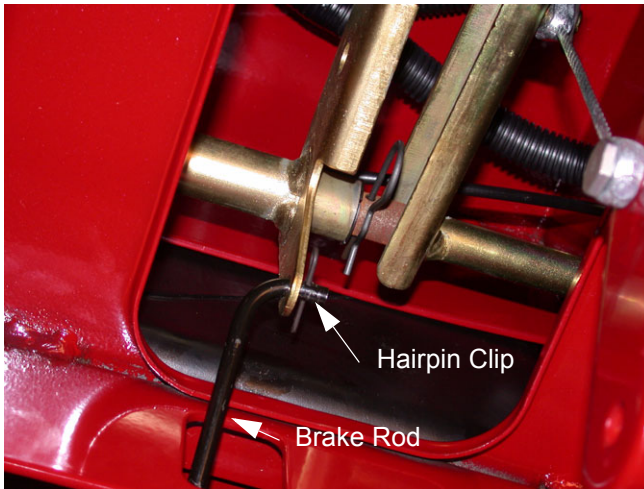

Figure 15.9

- 15.10. Remove the nine hex washer head tapp screws securing the seat box frame to the frame of the unit. See Figure 15.10.

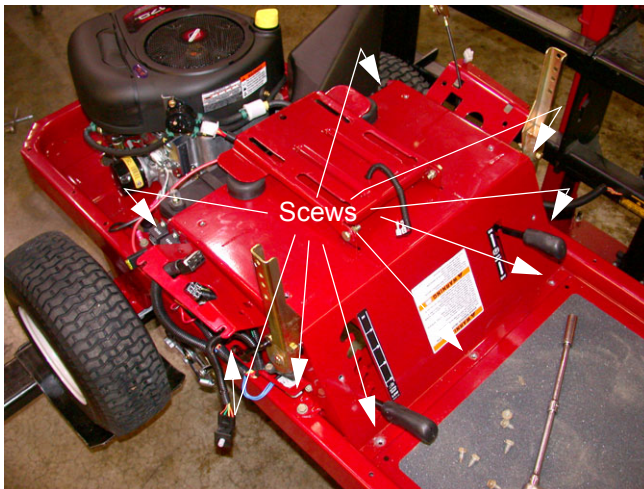

Figure 15.10

- 15.11. Slide the seat box frame forward to allow removal of the fuel tank.
- 15.12. Once the fuel tank is removed from the unit, disconnect the fuel line from the fuel pump and carefully remove fuel tank from unit.

NOTE: Make sure to clean up any spilled fuel.

NOTE: During reassembly be certain to reconnect electrical connector and fuel line.

NOTE: This would a good time to change the fuel filter.

16. CONTROL SHAFT REPLACEMENT

- 16.1. Disconnect the - (negative) lead to the battery.
- 16.2. Remove appropriate side console. refer to "CONSOLE REMOVAL" section of this manual.
- 16.3. Disconnect the ferrule from the return to neutral assembly. See Figure 16.3.

← Ferrule

Figure 16.3

- 16.4. Remove hex head cap screw and flat washer securing the control hub to the control shaft. See Figure 16.4.

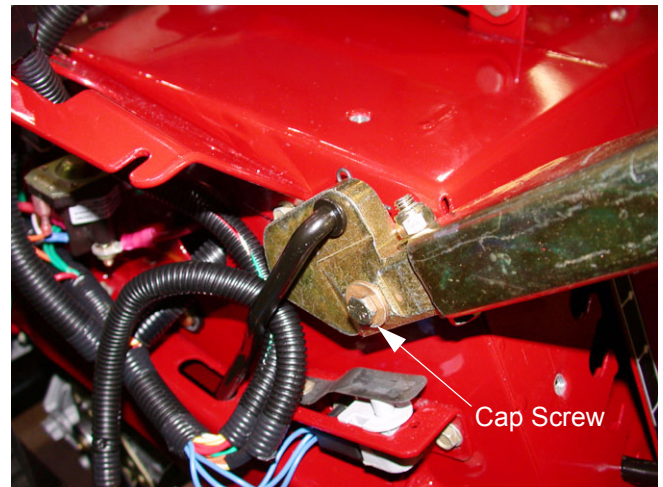

Figure 16.4

- 16.5. Remove hair pin securing the lapbar control rod to the control hub.

- 16.6. While rotating the control hub forward the lapbar control rod can be disconnected and removed. See Figure 16.6.



Figure 16.6

- 16.7. Pull the control hub off the control shaft. See Figure 16.7.

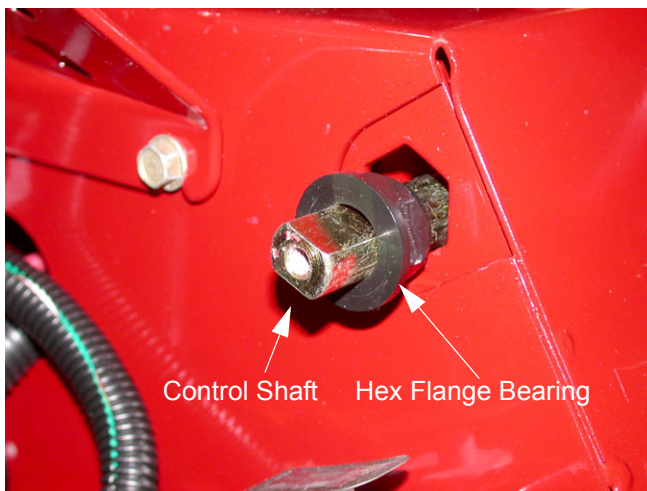

Figure 16.7

- 16.8. Remove outboard hex flange bearing. Inspect and replace as needed.

- 16.9. The control rod can be removed from underneath the seat frame box.

- 16.10. Inspect hex flange bearing and control shaft. Replace as needed.

NOTE: Applying anti-seize compound to the double “D” end of the control shaft will aid in future removal of the shaft.

NOTE: Undertaking the “**DECK REMOVAL**” section of this manual will make this procedure a little less painful but, is not necessary.

17. DECK LIFT SHAFT REPLACEMENT

- 17.1. The following sections of this manual need to be accomplished:

DECK REMOVAL

SEAT REMOVAL

CONSOLE REMOVAL, RIGHT AND LEFT SIDE

BATTERY REMOVAL

NOTE: THE DECK LIFT SHAFT ALSO DOUBLES AS THE FULCRUM POINT FOR THE PARKING BRAKE ROD AND HANDLE.

- 17.2. Remove the two screws securing the fuel tank mounting wire to the frame using a 1/2” socket. See Figure 17.2.

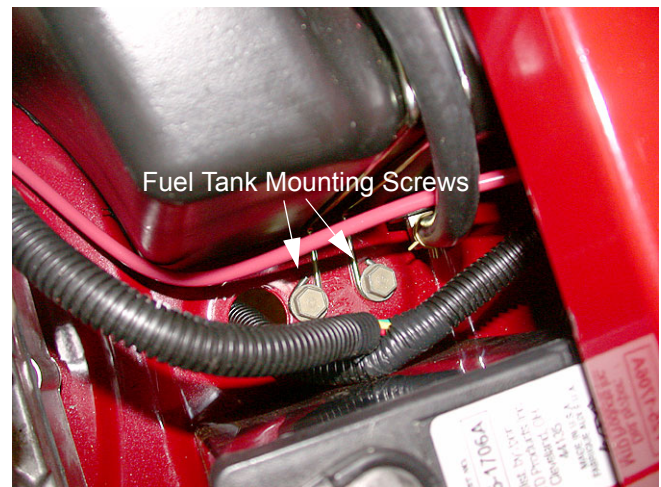

Figure 17.2

- 17.3. Remove fuel tank mounting wire and set off to the side.

- 17.4. Disconnect the electrical connection between the fuel tank and the engine. This will allow room for the fuel tank to be moved to get a wrench underneath.

17.5. Carefully lift the fuel tank and remove the hex head cap screw under the rear of the fuel tank securing the seat box frame to the frame.

NOTE: The fuel tank does NOT need to be taken out.

17.6. Using the same 1/2" socket, remove the other eight screws securing the seat box frame. There are a total of two in the rear, two on each side and three in the front for a total of nine. See Figure 17.6.



Figure 17.6

17.7. Disconnect the lapbar control rods from the return to neutral brackets. See Figure 17.7.

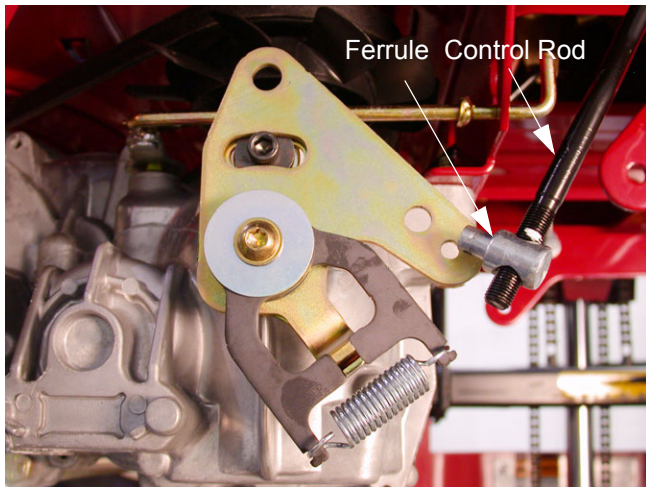

Figure 17.7

17.8. Using two 9/16" wrenches remove the bolt, nut, and spring on the brake handle on the left handle side of the deck lift shaft. See Figure 17.8.

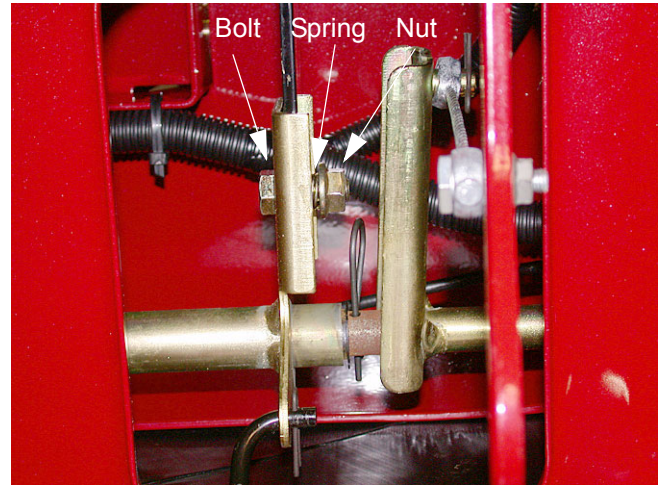

Figure 17.8

NOTE: When reassembling tighten screw.030 past flush to end of screw.

17.9. Remove the hairpins securing the deck lift cables to the deck lift shaft. See Figure 17.8.

17.10. Remove the large hairpin going through the center of the deck lift shaft on the left side of the shaft. See Figure 17.10.



Figure 17.10

NOTE: By removing this hairpin it will allow the concentric brake cross shaft to slide to the right to disconnecting the brake rods.

17.11. Remove the hairpin keeping the brake rods connected to the concentric brake cross shaft.

17.12. Slide the concentric brake cross shaft to the right allowing the brake rods to come out of the hole in the shaft. See Figure 17.12.

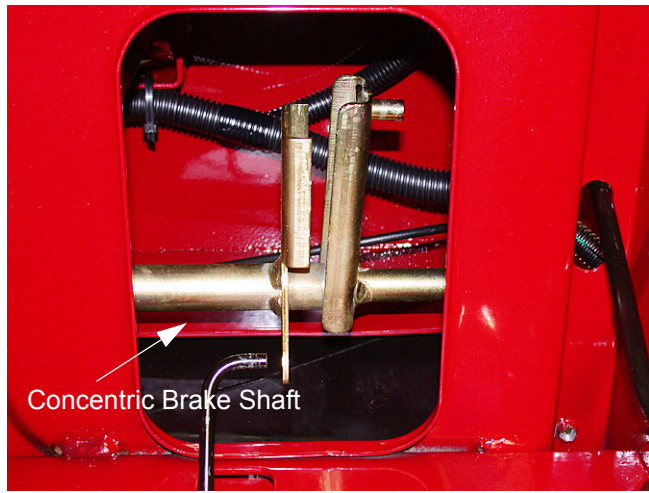

Figure 17.12

17.13. Remove rubber handle from the deck lift rod.

17.14. Carefully release the tension on the deck lift handle torsion spring. See Figure 17.14.



Figure 17.14

NOTE: Putting the deck lift handle in the lowest cutting position will make this task much easier.

17.15. Remove the E-clips on the ends of the deck lift shaft. See Figure 17.15.

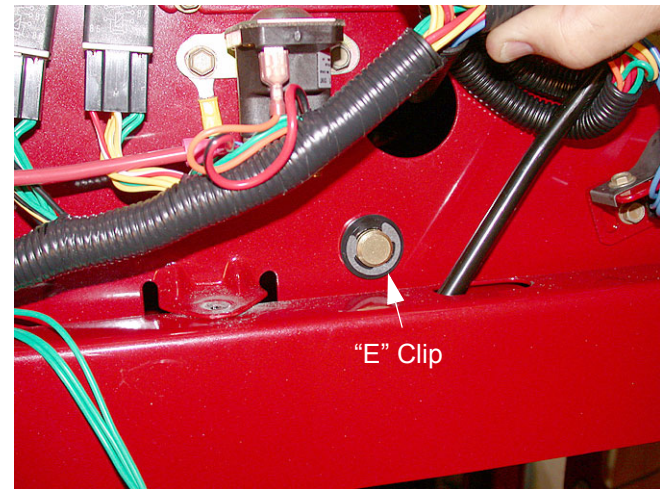

Figure 17.15

17.16. Remove both hex flange bearings.

17.17. Place a piece of 2 x 4 or something equivalent under the front, left side of the seat box frame. This will allow enough clearance for deck lift assembly to slip out the back easily. See Figure 17.17.

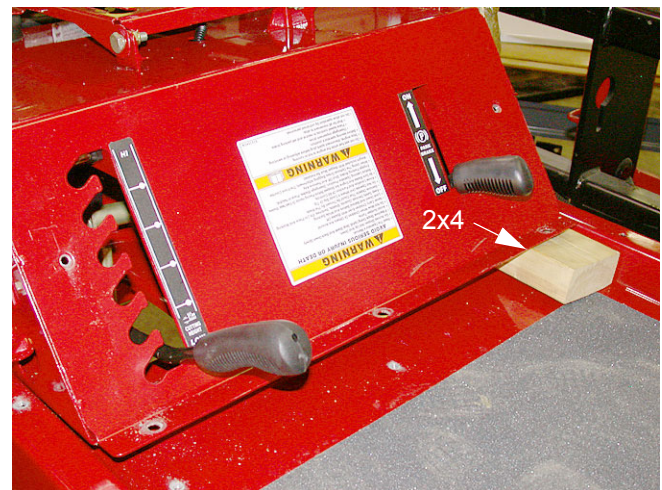

Figure 17.17

17.18. Shuffle the deck lift assembly to the left till the right side falls out of the seat box.

17.19. From this point the deck lift shaft and deck lift handle will slip out of the rear of the unit where the battery was. See Figure 17.19.

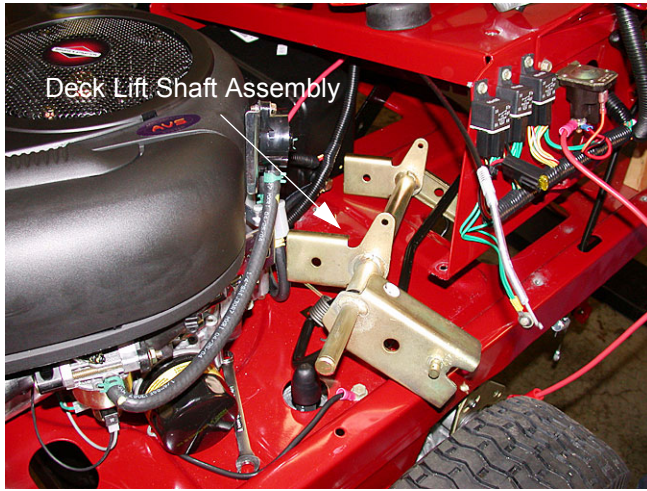

Figure 17.19

NOTE: The outer hex flange bearing on the deck lift shaft can be replaced with out removing the shaft.

NOTE: The split flange bearing on the deck lift handle can be replaced with out removing the deck lift shaft or deck lift handle.

18. ELECTRICAL SYSTEM COMPONENTS

This section is intended to help technicians identify the location and function of specific components on the RZT electrical system.

18.1. The SEAT SAFTY SWITCH is located under the seat assembly. See Figure 18.1.



Figure 18.1

The contacts on the switch are normally closed. This is indicated with the initials N.C. on the side of the spades.

-When the seat is unoccupied this will energize relay # 1 & 2.

NOTE: The seat safety switch has nothing to do with the starting circuit.

18.2. The PARKING BRAKE SWITCH is located under the seat box frame. See Figure 18.2.

-Both sets of contacts are normally open (N.O.).

-When the switch is activated the red wire supplies power to the seat switch. The red/white wire is for an indicator light on the hour meter. An orange wire goes to the starter solenoid. The orange/white wire goes to the PTO switch.

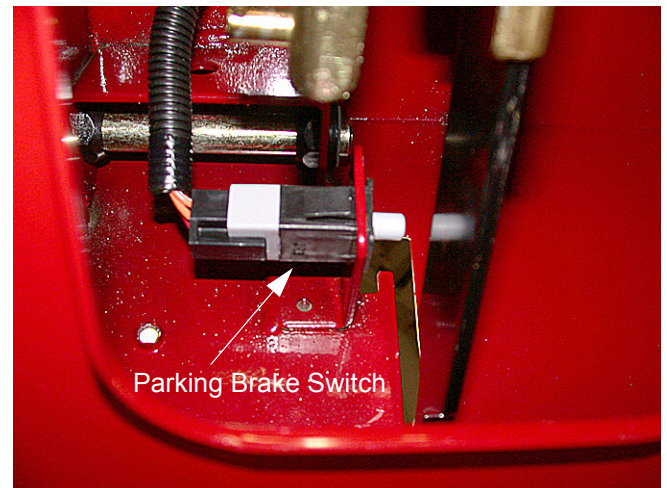

Figure 18.2

NOTE: The brake switch is part of the start circuit.

18.3. The NEUTRAL SWITCHES are in the console on each side of the unit. They are normally open/normally closed switches. See Figure 18.3.

-The two inner terminals are N.C. They have a yellow/white wire which supply a ground to center set of spades on the PTO switch and spade 87 on the brake relay.

-The two outer terminals are N.O. The left switch has a yellow/white wire which goes to the key switch and a orange that goes to the right neutral switch. The right neutral switch has the orange wire and a orange/black wire which leads to the PTO switch.

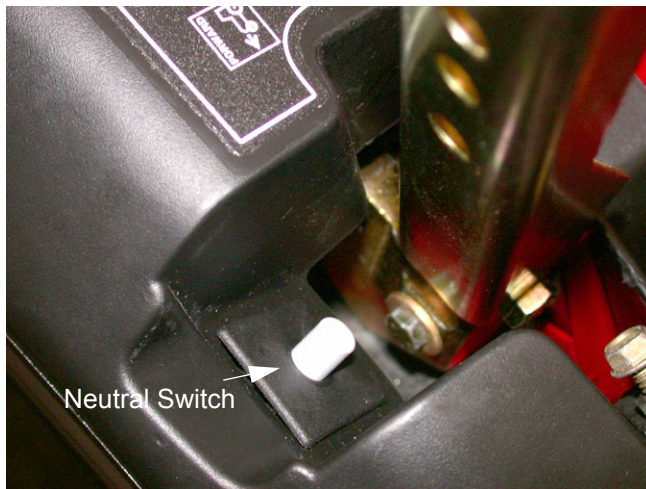

Figure 18.3

NOTE: These switches are part of the starting circuit.

18.4. The REVERSE SWITCHES are located just under the lapbars in the console. See Figure 18.4.

-There are two of these switches.

-These are normally closed switches (N.C.).

-The switches need to be set-up in a way that when the lapbar(s) are pulled to the rear the switch opens the circuit and eliminates power to the PTO from that switch.

-One lapbar can be pulled back at a time but, if both are pulled back that will cut power to the PTO. Returning one or both lapbars to neutral will reengage the PTO. This is done by wiring the switches in parallel

-If the reverse safety switch adjustment is not correct, loosen the reverse safety switch bracket using a 3/8" wrench. Pivot the bracket and switch to a position that results in correct operation, then tighten the bracket.

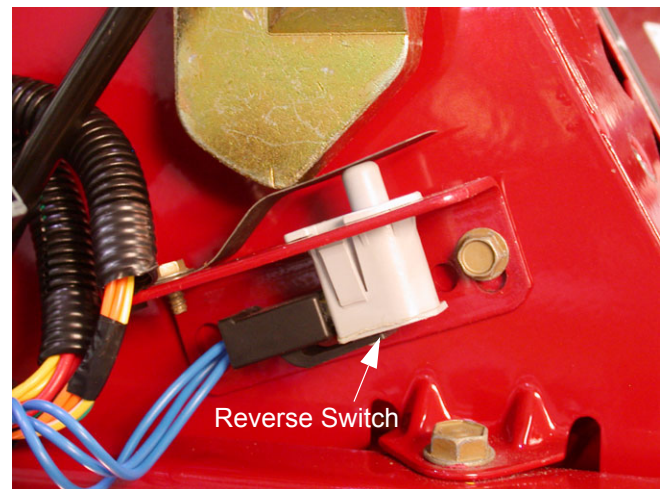

Figure 18.4

NOTE: It is not necessary to remove either control console to reach the reverse safety switches, but it may be necessary to temporarily disconnect the blue wires in order to reach the mounting screws for the brackets.

18.5. The PTO switch is located on the right console behind the key switch. This switch accomplishes many tasks, it is part of the start circuit, PTO run circuit, and reverse safety circuit. See Figure 18.5.

- The first set of terminals, start circuit, are the orange/white wire connecting to the brake switch and the orange/black wire going to the neutral switches. Of course, the PTO switch needs to be in the off position to start the unit.

-The second set of terminals, reverse safety circuit, consists of yellow/black wire connecting to the terminal "30" of the PTO relay and the yellow/white wire which connects to terminal "87" on the brake relay and neutral switches.

-The third and final set of terminals, PTO run circuit, consists of blue wire from the reverse safety switches and a red wire from the run line.

NOTE: If you are checking for power at the PTO switch, you should have 12 volts at the red wire and 0 volt at the blue wire with the PTO switch turned off. With the PTO switch on you will have 12 volts at both the blue and red wires. Be sure all other conditions are being met for the PTO to run properly.

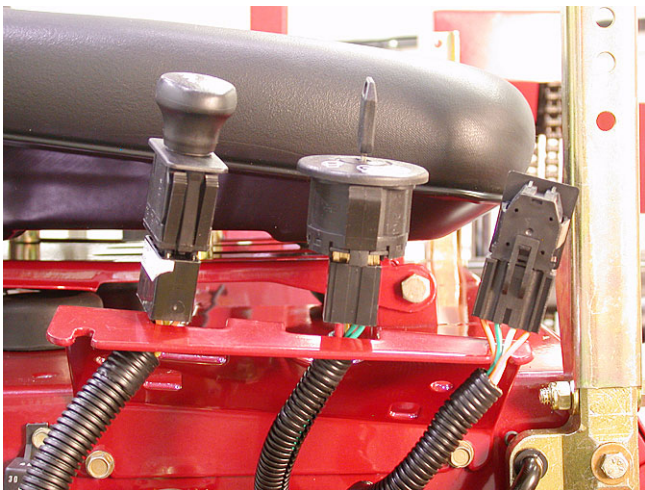

Figure 18.5

18.6. The KEY SWITCH is located on right console in front of the PTO switch.

-There was a midyear change to the key switch. Units with serial number before 1F014G20062 should have key switch 725-04019 (Delta switch number 6900-31P) and Harness 725-04170. When the old key switch is turned to the start position it doesn't energize the fuel shut off solenoid. This will not allow fuel to flow to the carburetor while the engine is cranking. To correct this, there is a new key switch (725-04228) and a harness adapter (725-04229). This is available in kit 759-04058 (service advisory CC-451)

-A new wiring harness 759-04170A should be on all models with serial numbers above 1F224G20001. These models will NOT need the harness adapter (759-04058) and will already have the proper key switch.

-To check for the proper key switch perform the following test.

NOTE: A multimeter or continuity tester will be need for this section.

Turn key to OFF position and check for continuity you should have continuity between G and M only.

Turn key to the RUN you should have continuity between L and B.

Turn and hold key in the Start position you should have continuity between L, B, and S.

18.7. -If this is the case then you have the most current switch. The old key switch is usually identical to the new switch. The difference being that the old switch when turned to START would have continuity between B and S only.

RELAYS

18.8. There are three RELAYS in the electrical system of the RZT. They are located under the right side console toward the rear. See Figure 18.8.

-The relays are assessable from under the rear of the console

-To replace a relay, the console does not need to be removed.

-When testing by feel a click should be felt when activated.

-Starting from the left they should be in the order of SEAT, PTO, and, BRAKE

-The SEAT RELAY should have a consistent ground (terminal 86) and will receive power (terminal 85) when the seat switch is activated.

-The PTO RELAY should have a consistent ground (terminal 86) and will also receive power (terminal 85) when the seat switch is activated.

-The BRAKE RELAY should have a consistent ground (terminal 86) and will receive power (terminal 85) when the brake switch is activated.

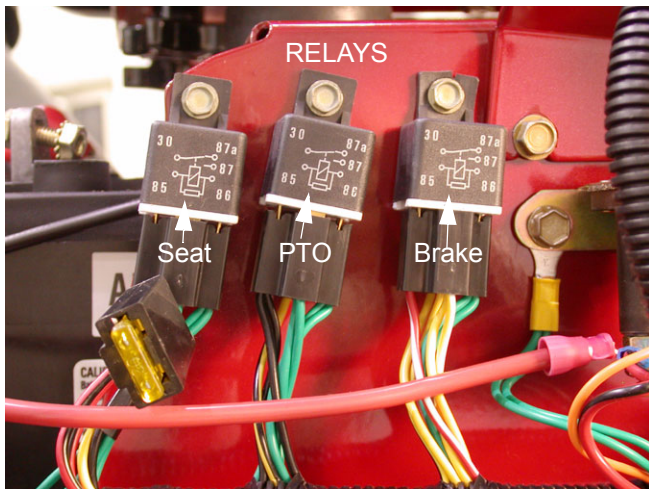

Figure 18.8

18.9. The STARTER SOLENOID is located under the right console just to the right of the relays.
See Figure 18.9.

- Be certain that there is a good path to ground by making sure there is a star washer under the mounting tab on the starter solenoid.

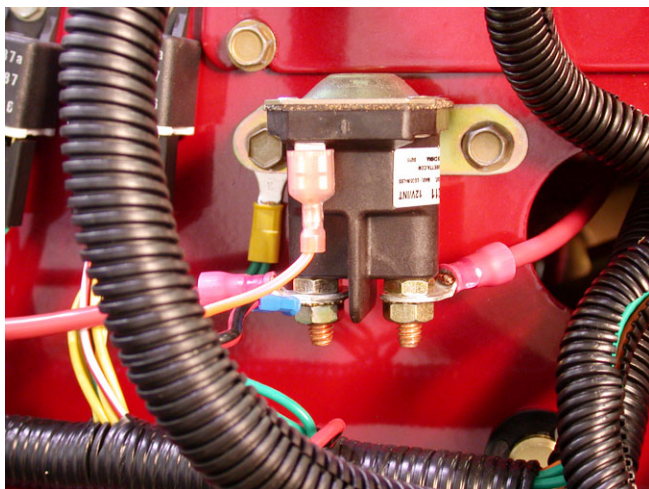
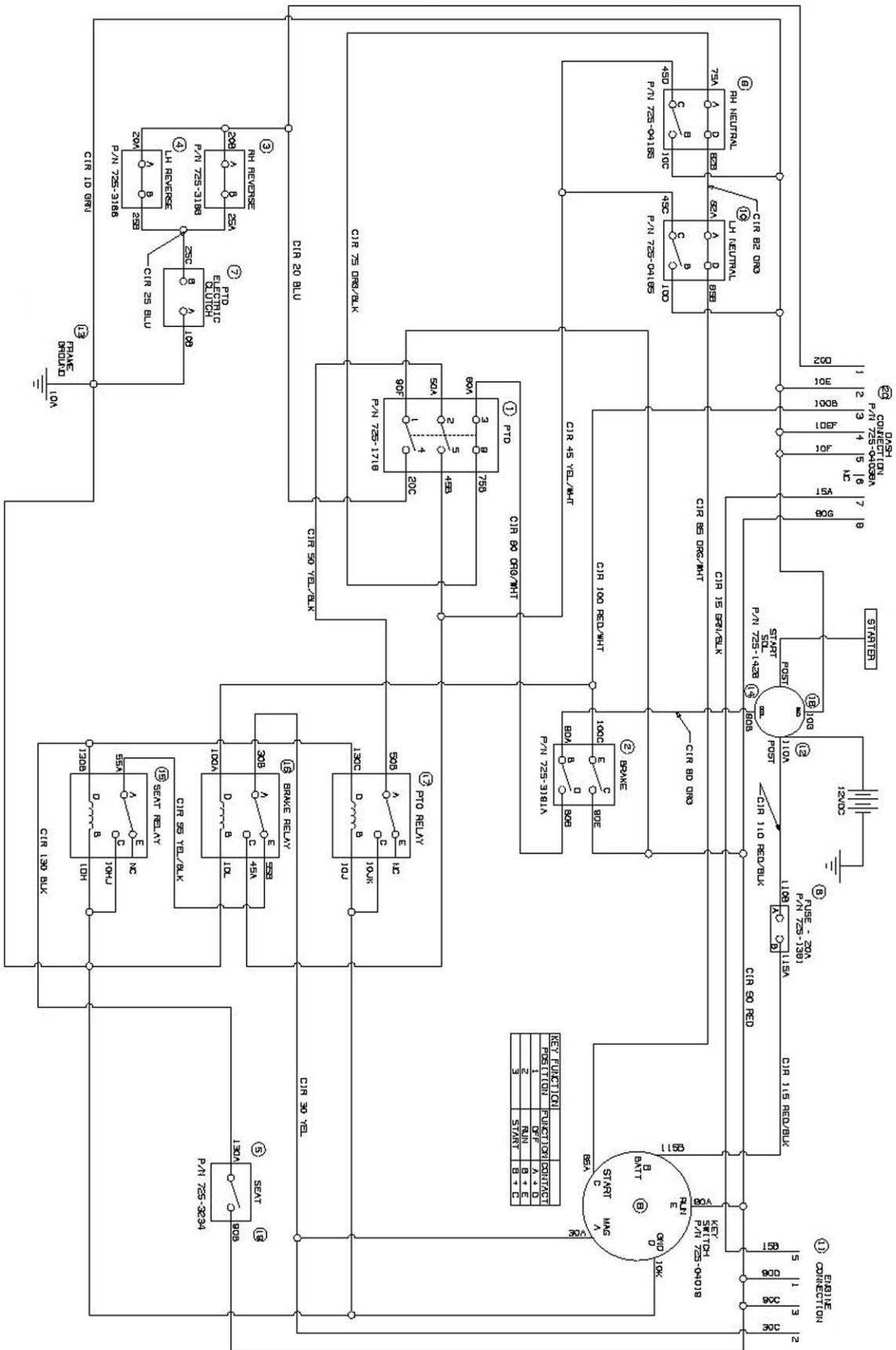

Figure 18.9



RELAY FUNCTION	FUNCTION CONTACT
1	RUN
2	STOP
3	START