

For Parts Call 606-678-9623 or 606-561-4983



Professional Shop Manual



78/83/90 Series Horizontal Shaft Engines (277/357/420 cc Engines)

NOTE: These materials are for use by trained technicians who are experienced in the service and repair of outdoor power equipment of the kind described in this publication, and are not intended for use by untrained or inexperienced individuals. These materials are intended to provide supplemental information to assist the trained technician. Untrained or inexperienced individuals should seek the assistance of an experienced and trained professional. Read, understand, and follow all instructions and use common sense when working on power equipment. This includes the contents of the product's Operators Manual, supplied with the equipment. No liability can be accepted for any inaccuracies or omission in this publication, although care has been taken to make it as complete and accurate as possible at the time of publication. However, due to the variety of outdoor power equipment and continuing product changes that occur over time, updates will be made to these instructions from time to time. Therefore, it may be necessary to obtain the latest materials before servicing or repairing a product. The company reserves the right to make changes at any time to this publication without prior notice and without incurring an obligation to make such changes to previously published versions. Instructions, photographs and illustrations used in this publication are for reference use only and may not depict actual model and component parts.

© Copyright 2010 MTD Products Inc. All Rights Reserved

www.mymowerparts.com

For Parts Call 606-678-9623 or 606-561-4983

www.mymowerparts.com

Table of Contents

Chapter 1: Introduction

Professional Service Manual Intent	1
Safety	1
Fasteners	3
Assembly instructions	3
Model and serial number	4
Maintenance	5
Air filter (summer engines)	6
Oil type and capacity	7
Changing the oil	8
Fuel	9
Fuel filters	9
Valve lash	11
Cleaning the engine	13
General torque specifications	14
Maintenance Chart	14
Frequently used specifications	15

Chapter 2: Basic Troubleshooting

Definitions	17
Introduction	17
Steps to troubleshooting	17
Define the problem	17
Identify factors that could cause the problem	18
Repairing the problem	23
Prime test	24
Leak-down test	24
Compression test	26
PCV testing	27

Chapter 3: Air Intake systems

Heat box (snow engines)	29
Air filter (summer engines)	30
Air filter base and control panel (summer engines)	32
Carburetor and Insulator	34

Chapter 4: The Fuel System and Governor

Inspecting the fuel	37
Test fuel for alcohol	38
Fuel tank vent	39
The fuel filter	40
Inspect the fuel lines	40
The fuel tank	41
Evaporative (EVAP) emissions system	42
Troubleshooting the EVAP System	44
Charcoal canister	46
Roll over valve	47
Choke	48
Primers (snow engines)	50
Carburetors	51
Inspecting the carburetor	51
Disassembly and rebuilding of the carburetor	52
Fuel shut-off valve	56
Governor	58
Governor arm	58
Governor shaft	59
Governor cup and the governor gear	60
Governor adjustment	61

Chapter 5: Lubrication

Oil type and quantity	63
Oil dip stick	64
Dip stick tube removal	65
Lubrication system	66
Positive crankcase ventilation valve	67

Chapter 6: Starter and Charging Systems

Recoil Starter Removal	69
Starter Cup	70
Starter Rope	71
Starter pulley and recoil spring	73
Electric starter	75
Charging system	77
Charging system testing	78
Stator	79
Rotor	79

Chapter 7: Ignition System

Troubleshooting the ignition system	81
Stop switch	82
Remote (ignition) stop switch (snow engines)	83
Test for ignition that won't turn off	84
The module	85
Module removal	86
Installing the module and setting the air gap	87
Flywheel	88
About the spark plug	89
Cleaning the spark plug	89
Inspection of the spark plug	89
Spark plug removal	89

Chapter 8: Exhaust

Summer engines	91
Spark arrestor (if equipped)	91
Muffler removal/replacement	92
Muffler removal/replacement (snow engines)	94

Chapter 9: Cylinder Head

Cylinder head removal	97
Cylinder head installation	100
Valves	101

Chapter 10: Crankshaft, piston and Connecting Rod

Crankshaft inspection	108
Piston Inspection	109
Connecting rod inspection	111
Cylinder inspection	111
Balance Shaft (483 & 490)	112
Reassembly	113
Engine specifications chart	115
Engine torque values chart	119

Chapter 11: Failure Analysis

Abrasive Ingestion	121
Insufficient lubrication	124
Engine Overspeed	125
Overheated	126
Mechanical Breakage/ Wear	127
Detonation/preignition	127

For Parts Call 606-678-9623 or 606-561-4983

CHAPTER 1: INTRODUCTION

Professional Service Manual Intent

This manual is intended to provide service dealers with an introduction to proven diagnostic and repair procedures for 78/83/90 series MTD horizontal shaft engines.

Disclaimer: The information contained in this manual is correct at the time of writing. Both the product and the information about the product are subject to change without notice.

About the text format:

NOTE: Is used to point out information that is relevant to the procedure, but does not fit as a step in the procedure.

- Bullet points: indicate sub-steps or points.



Caution is used to point out potential danger to the technician, operator, bystanders, or surrounding property.



Warning indicates a potentially hazardous situation that, if not avoided, could result in death or serious injury.



Danger indicates an imminently hazardous situation that, if not avoided, will result in death or serious injury. This signal word is to be limited to the most extreme situations

1. Numbered steps indicate specific things that should be done, and the order in which they should be done.
 - 1a. Substeps will be lettered and nested within steps. Two or more substeps may be combined to describe the actions required to complete a step.

Disclaimer: This manual is intended for use by trained, professional technicians.

- Common sense in operation and safety is assumed.
- In no event shall MTD be liable for poor text interpretation or poor execution of the procedures described in the text.
- If the person using this manual is uncomfortable with any procedures they encounter, they should seek the help of a qualified technician or MTD Technical Support.

Safety

This Service Manual is meant to be used along with the Operator's Manual. Read the Operator's Manual and familiarize yourself with the safety and operational instructions for the equipment being worked on. Keep a copy of the Operator's Manual for quick reference. Operator's manuals may be viewed for free at the brand support website. It will be necessary to have the complete model and serial number for the equipment.

78/83/90 Series Horizontal Shaft Engines



- Be prepared in case of emergency:
 - Keep a fire extinguisher nearby
 - Keep a first aid kit nearby
 - Keep emergency contact numbers handy
- Replace any missing or damaged safety labels on shop equipment.
- Replace any missing or damaged safety labels on equipment being serviced.



- Grooming and attire:
 - Do not wear loose fitting clothing that may become entangled in equipment.
 - Long hair should be secured to prevent entanglement in equipment.
 - Jewelry is best removed.
- Protective gear: includes, but is not limited to
 - Clear eye protection while working around any machinery
 - Protective gloves where necessary
 - Armored footwear when working around any machinery
 - Hearing protection in noisy environments
 - Chemically resistant gloves when working with chemicals or solvents
 - Respirator when working with chemical or solvents
 - Appropriate tinted eye protection..... when cutting or welding
 - Flame resistant headgear, jacket, chaps . when cutting or welding



- Remember that some hazards have a cumulative effect. A single exposure may cause little or no harm, but continual or repeated exposure may cause very serious harm.
- Clean spills and fix obviously dangerous conditions as soon as they are noticed.
- Lift and support heavy objects safely and securely.
- Be aware of your surroundings and potential hazards that are inherent to all power equipment. All the labels in the world cannot protect a technician from an instant of carelessness.



- Exhaust fumes from running engines contain carbon monoxide (CO). Carbon monoxide is a colorless odorless gas that is fatal if inhaled in sufficient quantity. Only run engines in well ventilated areas. If running engines indoors, use an exhaust evacuation system with adequate make-up air ventilated into the shop.

Fasteners

- Most of the fasteners used on the MTD engine are metric. Some are fractional inches. For this reason, wrench sizes are frequently identified in the text, and measurements are given in U.S. and metric scales.
- If a fastener has a locking feature that has worn, replace the fastener or apply a small amount of releasable thread locking compound such as Loctite® 242 (blue).
- Some fasteners, like cotter pins, are single-use items that are not to be reused. Other fasteners such as lock washers, retaining rings, and internal cotter pins (hairpin clips) may be reused if they do not show signs of wear or damage. This manual leaves that decision to the judgement of the technician.

Assembly instructions

- **Torque specifications** may be noted in the part of the text that covers assembly. They may be summarized in tables along with special instructions regarding locking or lubrication. Whichever method is more appropriate will be used. In many cases, both will be used so that the manual is handy as a quick-reference guide as well as a step-by-step procedure guide that does not require the user to hunt for information.
- **Lubricant** quantity and specification may be noted in the part of the text that covers maintenance, and again in the section that covers assembly. They may also be summarized in tables along with special instructions. Whichever method is more appropriate will be used. In many cases, the information will be found in several places in the manual so that the manual is handy as a quick-reference guide as well as a step-by-step procedure guide that does not require the user to hunt for information.
- The level of assembly instructions provided will be determined by the complexity of reassembly, and by the potential for damage or unsafe conditions to arise from mistakes made in assembly.
- Some instructions may refer to other parts of the manual for subsidiary procedures. This avoids repeating the same procedure two or three times in the manual.

78/83/90 Series Horizontal Shaft Engines

Model and serial number

The model and serial number can be found on a white sticker with a bar code. The sticker is located on the right side of the engine at the bottom of the block. See Figure 1.1.

NOTE: The serial number will always start with the model number.

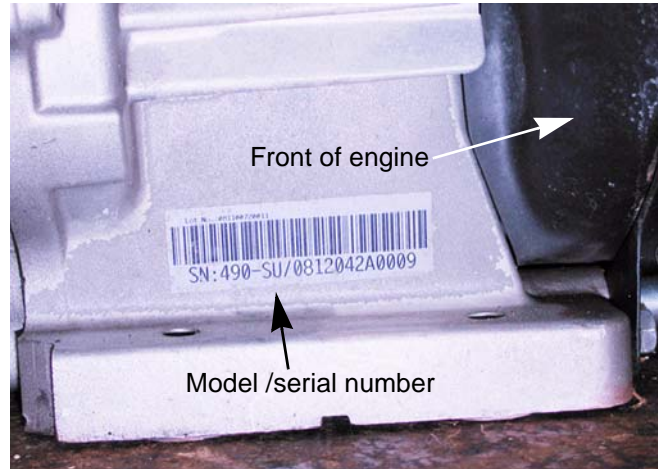
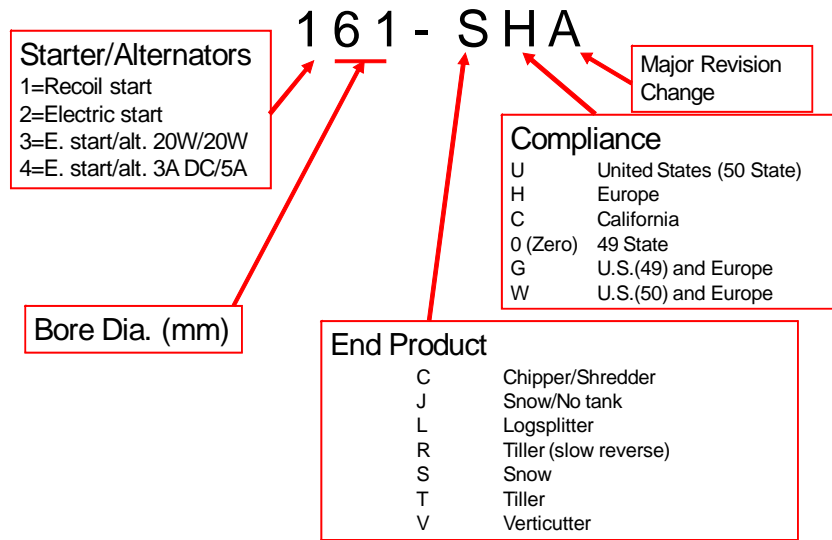
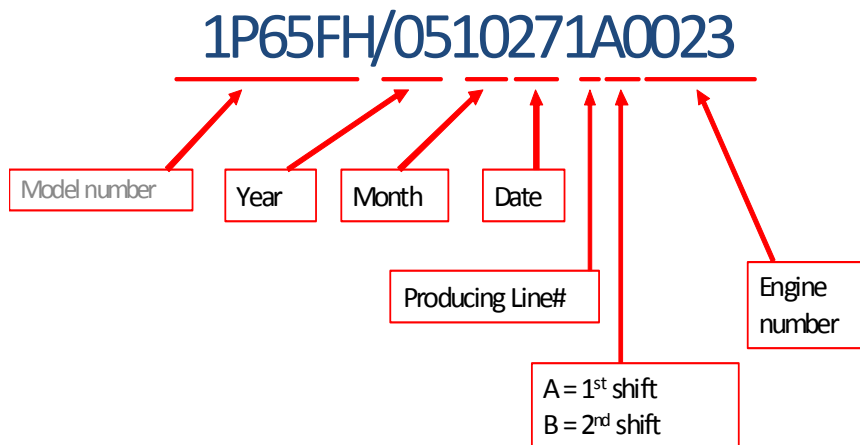

Figure 1.1

MTD Horizontal Engine Model Designators



MTD Engine Serial Numbers



Maintenance



Figure 1.2

The information in this manual applies to the MTD engine. Some basic principles may apply to engines produced by other manufacturers.

As the saying goes “an ounce of prevention is worth a pound of cure”. The same can be said about preventive maintenance on outdoor power equipment. By changing the spark plug and oil at recommended intervals many failures can be avoided.

NOTE: Please refer to Chapter 7: Ignition for the complete service instructions on spark plugs.

1. The spark plug used in the MTD engine is a F6RTC gapped to 0.026” - 0.030” (0.65 - 0.75 mm). See Figure 1.2.

NOTE: The F6RTC plug is the only plug that is EPA certified for the MTD engine.

2. Wear rate will vary somewhat with severity of use. If the edges of the center electrode are rounded-off, or any other apparent wear / damage occurs, replace the spark plug before operating failure (no start) occurs.

3. Cleaning the spark plug:

NOTE: MTD does not recommend cleaning spark plugs. Use of a wire brush may leave metal deposits on the insulator that causes the spark plug to short out and fail to spark. Use of abrasive blast for cleaning may cause damage to ceramic insulator or leave blast media in the recesses of the spark plug. When the media comes loose during engine operation, severe and non-warrantable engine damage may result.

4. Inspection of the spark plug can provide indications of the operating condition of the engine.

- Light tan colored deposits on insulator and electrodes is normal.
- Dry, black deposits on the insulator and electrodes indicate an over-rich fuel / air mixture (too much fuel or not enough air)
- Wet, black deposits on the insulator and electrodes indicate the presence of oil in the combustion chamber.
- Heat damaged (melted electrodes / cracked insulator / metal transfer deposits) may indicate detonation.
- A spark plug that is wet with fuel indicates that fuel is present in the combustion chamber, but it is not being ignited.

78/83/90 Series Horizontal Shaft Engines

Air filter (summer engines)

Generally air filters come in two different types, a pleated-paper element or foam. A combination of the two are used on the MTD engine. See Figure 1.3.

1. The main function of the air filter is to trap air borne particles before they enter the engine. Dirt ingestion can cause serious internal engine damage.

NOTE: Snow engines do not have air filters because the snow will plug up the filter. Generally the air is clean enough that there is minimal risk of dirt ingestion when the ground is covered with snow.

2. Air filters used on the MTD engine are designed to prevent particles larger than 3-5 micron from passing through into the engine.
3. The filter should be checked on a regular basis possibly several times in a season.
4. Typically an air filter should be changed before every season.
5. If a foam air pre-cleaner is dirty, but not in bad of condition it can be cleaned and reused. The paper pleated filters can be shaken or lightly tapped to free the debris from the filter.

NOTE: Never use compressed air on a paper air filter. Compressed air will remove the tiny fibers that are used to catch the dirt in the air. Without these fibers the filter is useless.

6. Foam pre-filters can be washed in warm soapy water.

NOTE: When drying a foam filter either squeeze it in side of a paper towel or let it air dry DO NOT wring it because the filter will tear.

7. Before installing any foam filter, after it has been washed, it needs to be free of moisture.

NOTE: Always check with factory specification prior to servicing/replacing any engine components.

NOTE: Do not oil the foam pre-filter. The paper filter will absorb the oil and it will become plugged.

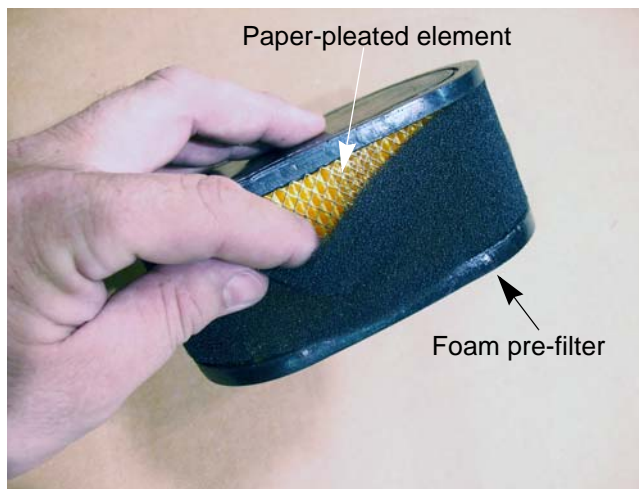

Figure 1.3

Oil type and capacity

MTD engines use oil with a SF/SG API rating or better is the recommended oil for this engine. The winter engines use SAE 5W-30 oil and the summer engines use SAE 10W-30 oil. The oil capacity for all of the 78/83/90 series engines is 37 fl.oz (1.1 liters).

- Check the oil level frequently and change the oil more frequently in severe operating conditions such as exceptionally deep snow falls.
- Synthetic oil is a suitable alternative, but it does not extend service intervals.

NOTE: MTD recommends the use of petroleum oil during the break in period to ensure the piston rings correctly break in.

- Synthetic vs. Petroleum based oil: To simply look at synthetic oil and to compare it with Petroleum based oil there is very little difference. However, when you look at the two through a microscope it is easy to see the difference. Synthetic is made up of smaller molecules. This allows the oil to get into areas that petroleum based oil cannot.
- No oil additives or viscosity modifiers are recommended. The performance of a good oil meeting the API specifications will not be improved by oil additives.

NOTE: Some oil additives may cause severe and non warrantable engine damage, constituting a lubrication failure.

NOTE: If the oil is noticeably thin, or smells of gasoline, a carburetor repair may be needed before the engine can be run safely.

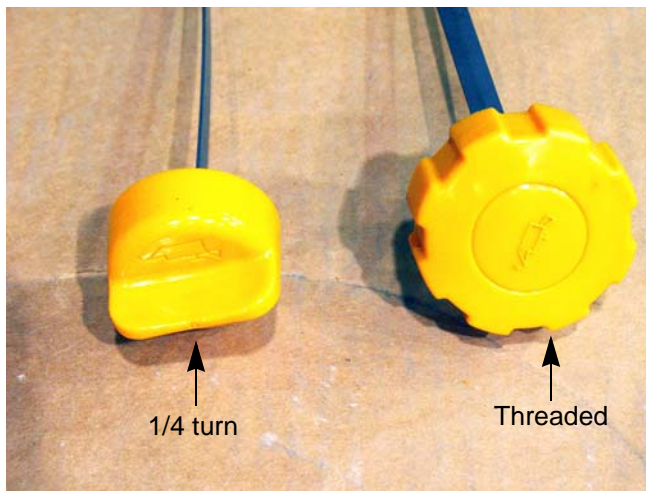

Figure 1.4

NOTE: There are two types of dip sticks that can be found on MTD engines; a threaded dip stick that was used on older engines and a quarter turn dip stick that is used on engines currently being produced. See Figure 1.4.

78/83/90 Series Horizontal Shaft Engines

To check the oil with a threaded dip stick:

1. Twist and remove the dip stick from the engine.
2. Clean the oil off of the tip of the dipstick.
3. Re-insert the dipstick **without** threading it in to get the oil level reading. See Figure 1.5.
4. The oil level is determined by the lowest point on the dipstick that is completely covered with oil.



Figure 1.5

To check the oil with a 1/4 turn dip stick:

1. Twist and remove the dip stick from the engine.
2. Clean the oil off of the tip of the dipstick.
3. Re-insert the dipstick **and turn it until it is fully seated** to get the oil level reading. See Figure 1.6.
4. The oil level is determined by the lowest point on the dipstick that is completely covered with oil.

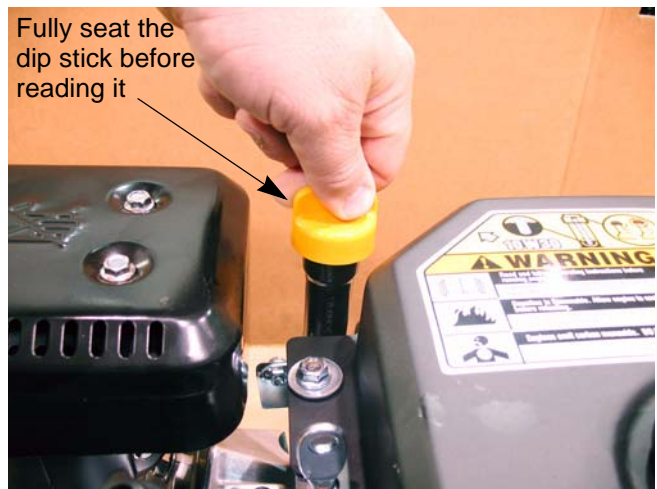

Figure 1.6

Changing the oil

NOTE: If the engine has been running, allow the engine to cool before doing any maintenance work.

NOTE: The oil should be changed after the first 5 hours of operation and every 50 hours thereafter.

1. Place a suitable drain pan under the drain plug to collect the oil.
2. Drain the oil by removing the drain plug located at the end of the extension pipe threaded into the base of the engine, using a 10mm wrench. See Figure 1.7.
3. When all of the oil has drained out, reinstall the drain plug. Tighten the drain plug to a torque of 106-124 in-lbs (12-14 Nm).
4. Fill the engine with 37 fl.oz (1.1 liters) of fresh, clean oil that is the appropriate weight for the application.
5. Safely dispose of the used oil according to the local laws and regulations.

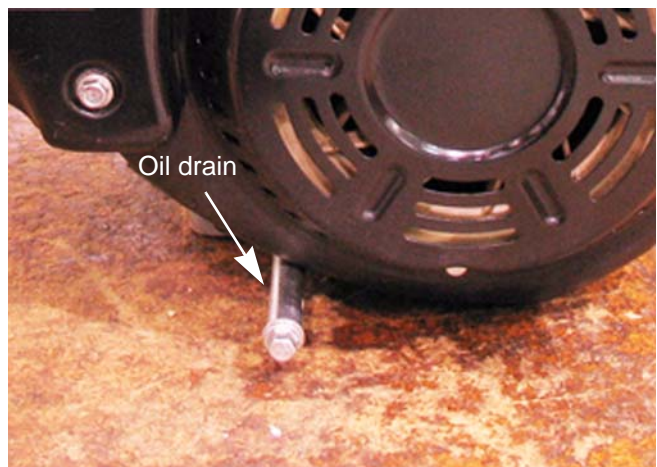

Figure 1.7

Fuel

Gasolines currently on the market are not pure gasoline. Today's fuels have alcohol and other additives in them to reduce emissions. The fuel make up can vary seasonally and geographically.

Fuel with alcohol added to it is sometimes referred to as "oxygenated fuel". The extra oxygen carried by the ethanol increases the oxidation of the fuel. This speeds up the process that causes the fuel to go bad.

Excessive alcohol in fuel creates a lot of problems for gasoline engines. One of the biggest problems is that alcohol attracts and holds water. This corrodes the metal components of the fuel system, especially the carburetor. Alcohol also does not produce as much heat as gasoline when burnt. This results in less power for the engine.

A 10% alcohol mix (E10) is acceptable for MTD engines. Anything higher than that will result in performance issues.

NOTE: E85 and E20 fuels are not to be used in any MTD engines.

NOTE: Use clean, fresh fuel with a pump octane rating of 87 or greater.

- Stale or out-of-date fuel is the leading cause of hard starting issues.
- In areas that have high amounts of alcohol in their fuel, high octane fuel may improve engine performance and startability.

Fuel filters

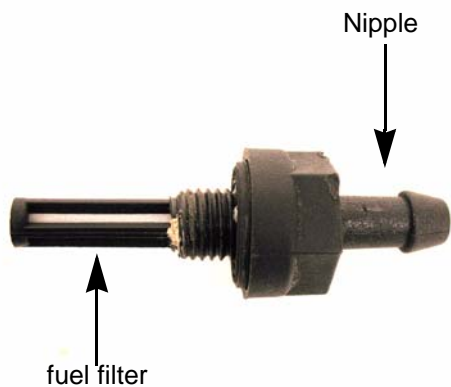

Figure 1.8

Dirty fuel can clog the carburetor and introduce abrasive materials into the engine. To help prevent that, MTD engines are equipped with a fuel filter. The fuel filter is part of the fuel tank nipple. See Figure 1.8.

78/83/90 Series Horizontal Shaft Engines

To replace the fuel filter:

WARNING

To avoid personal injury or property damage, use extreme care in handling gasoline. Gasoline is extremely flammable and the vapors are explosive. Serious personal injury can occur when gasoline is spilled on yourself and/or your clothes which can ignite. Wash your skin and change clothes immediately.

1. Siphon the fuel out of the fuel tank.
2. Remove the front fuel tank shroud using a 10 mm wrench. See Figure 1.9.

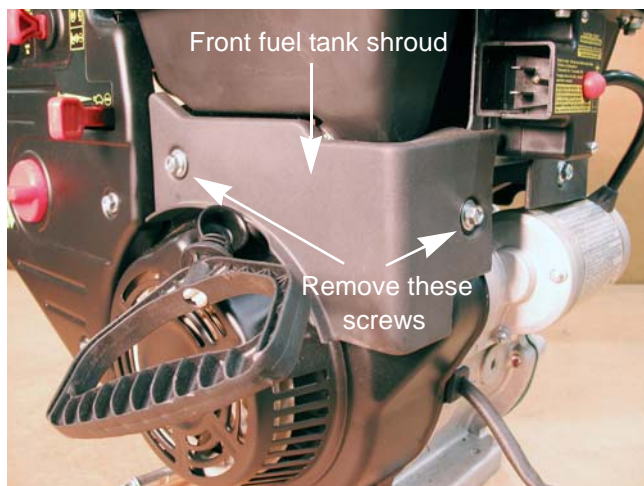

Figure 1.9

3. Remove the fuel line from the fuel tank nipple:
 - 3a. Squeeze the tabs on the fuel line clamp with a pair of pliers while sliding the clamp down the fuel line away from the nipple. See Figure 1.10.
 - 3b. Gently work the fuel line off of the nipple.

WARNING

Residual fuel in the fuel tank will come out when the fuel line is removed. Safety goggles are recommended to help prevent gasoline from splashing into your eyes.

4. Remove the fuel tank nipple using a 17 mm wrench.
5. Install a new filter by following the above steps in reverse order.

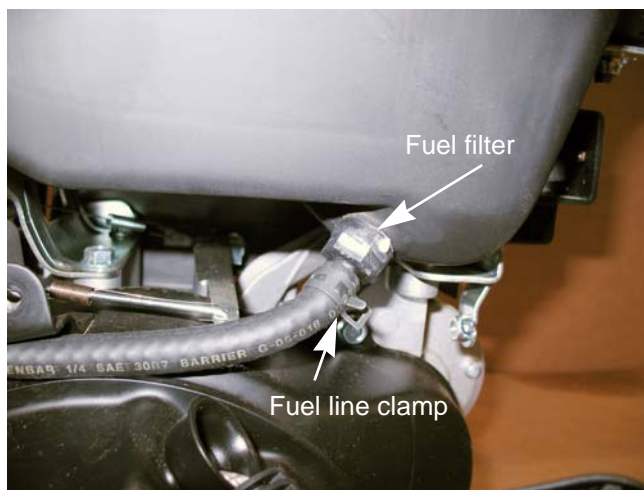

Figure 1.10

NOTE: Apply a small amount of releasable thread locking compound such as Loctite® 242 (blue) and tighten the filter by hand and then an additional 3/4 to 1 full turn to compress the gasket.

Valve lash

Valve lash is the clearance between the top of the valve stem and the rocker arm. The valve lash should be checked after the first 25 hours of use and every 100 hours after that. Valve lash can be checked and adjusted using the following steps:

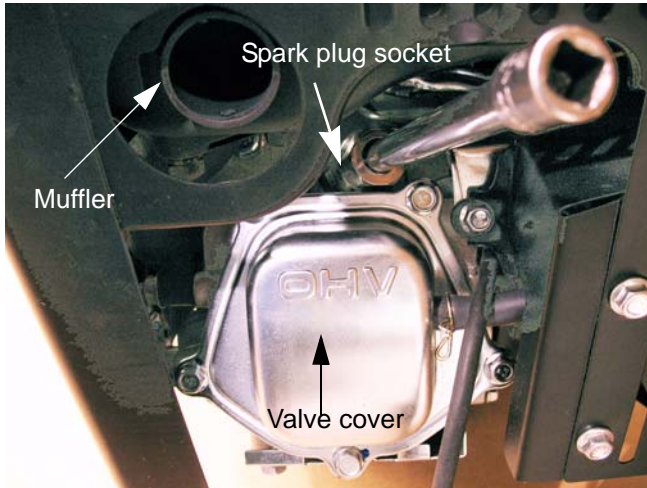

Figure 1.11

1. If the engine has been run, allow it to cool thoroughly. Position the equipment for easy access to the cylinder head.
2. Disconnect the high-tension lead from the spark plug and ground it well away from the spark plug hole.
3. Remove the spark plug using a 13/16" or 21mm wrench. A flexible coupling or "wobbly" extension may help. See Figure 1.11.

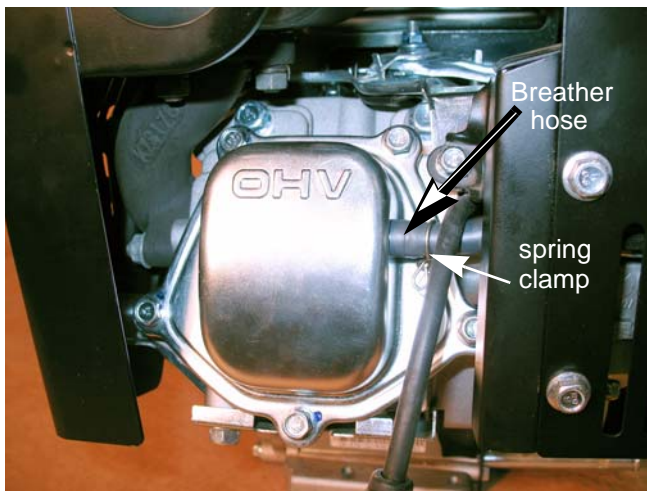

Figure 1.12

4. Disconnect the breather hose from the valve cover. See Figure 1.12.
5. Remove the five bolts that secure the valve cover using a 10mm wrench. Remove the valve cover from the engine.

NOTE: If care is taken not to damage the valve cover gasket, it can be re-used.

78/83/90 Series Horizontal Shaft Engines

6. Slowly pull the starter rope until air can be heard coming out of the spark plug hole.
7. Confirm that the piston is at Top-Dead-Center on the compression stroke. See Figure 1.13.
 - The compression stroke can be distinguished from the overlap stroke by the presence of air pressure at the spark plug hole and the fact that neither of the valves should move significantly on the compression stroke.
 - There is an automatic compression release mechanism that “bumps” the exhaust valve as the piston rises on the compression stroke. At TDC, the exhaust valve should be fully closed.

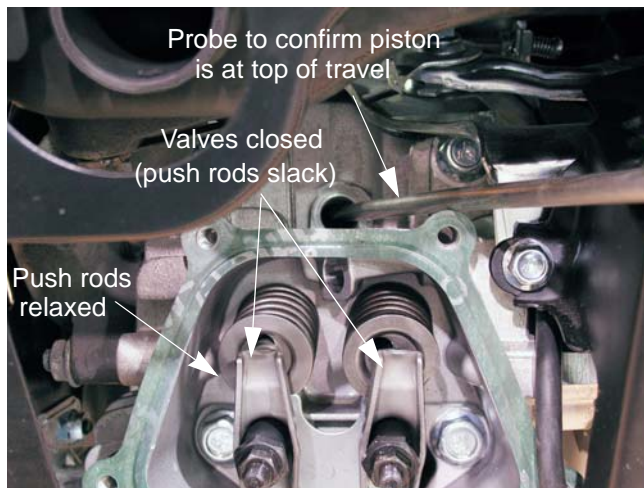

Figure 1.13

8. Check valve lash between each valve stem and rocker arm using a feeler gauge.
9. Intake valve lash (carburetor side) should be 0.004”-0.006” (0.10 - 0.15mm). See Figure 1.14.



Figure 1.14

10. Exhaust valve lash (muffler side) should be 0.006-0.008” (0.15 - 0.20mm). See Figure 1.15.
11. Use a 10mm wrench to loosen the jam nut, and a 14mm wrench to adjust the rocker arm fulcrum nut. See Figure 1.15.
 - Tighten the rocker arm fulcrum nut to close-up the clearance between the end of the valve stem and the contact point on the rocker arm.
 - Loosen the rocker arm fulcrum nut to open-up the clearance between the end of the valve stem and the contact point on the rocker arm.
12. Hold the fulcrum nut with a 14mm wrench, tighten the jam nut to a torque of 80 - 106 in-lb. (9-12 Nm) using a 10mm wrench.

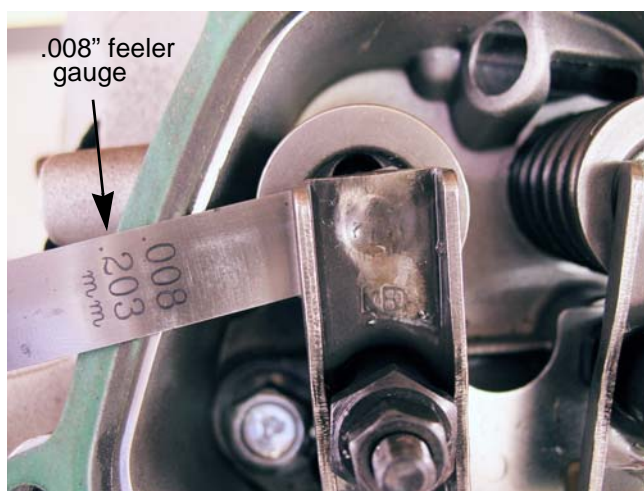

Figure 1.15

13. Double-check the clearance after tightening the jam nut, to confirm that it did not shift. Re-adjust if necessary.
14. Rotate the engine through several compression cycles:
 - Observe the movement of the valve gear.
 - Return the piston to TDC compression stroke and re-check the valve lash to confirm consistent movement of the valve gear, including the slight bump to the exhaust valve from the automatic compression release.
15. Clean-up any oil around the valve cover opening, clean the valve cover, replace the valve cover gasket if necessary.
16. Install the valve cover, tightening the valve cover screws to a torque of 62 - 80 in-lbs (7-9 Nm).
IMPORTANT: Over tightening the valve cover will cause it to leak.
17. Install the spark plug.

Cleaning the engine

1. To maintain a proper operating temperature and to keep the equipment looking good; all debris should be removed from the engine.
2. It is recommended to use compressed air to blow all of the debris off of the engine.
NOTE: A pressure washer may be used to clean outdoor power equipment **but only** after the unit has been allowed to properly cool.
NOTE: Mice and other critters tend to build nests inside the engine shrouds while the snow blower is stored during the long off season.

78/83/90 Series Horizontal Shaft Engines

General torque specifications

		size	M4	M5	M6	M8	size	M10	M12	M14
Grade 4.8	in-lbs		11	22	38	93	ft-lbs	16	27	43
	Nm		1.2	2.5	4.3	10.5	Nm	21.7	36.6	58
5.8	in-lbs		15	28	50	120	ft-lbs	20	35	55
	Nm		1.7	3.2	5.7	13.6	Nm	27.1	47.5	76
8.8	in-lbs		26	51	88	216	ft-lbs	35	61	97
	Nm		2.9	5.8	9.9	24.4	Nm	47.5	82.7	132
10.9	in-lbs		36	72	124	300	ft-lbs	49	86	136
	Nm		4.1	8.1	14	33.9	Nm	66.4	116.6	184
12.9	in-lbs		44	86	146	360	ft-lbs	60	103	162
	Nm		5	9.7	16.5	40.7	Nm	81.4	139.7	220
Noncritical Fasteners in Aluminum	in-lbs		18	35	60	150	ft-lbs	25	45	70
	Nm		2	4	6.8	17	Nm	33.9	61	95

Maintenance Chart

Maintenance item	Each use	Each 25 hrs. use	Each 50 hrs. use
Check oil	*		
Check air filter (If applicable)	*		
Note on air filter	Dirt may be shaken or tapped out of the air filter, but compressed air is not to be used for cleaning. Do not wash or oil paper filter element.		
Note on pre-filter	Foam pre-filter may be washed in water and mild detergent, and re-used. Do not oil.		
Check & gap spark plug	Replace if worn.		*
Check cooling fins	After prolonged storage		
Change oil			*
Note on oil:	Change oil after first 5 hrs. of use, and before prolonged storage.		
Valve lash	After the first 25 hrs. of use and every 100 hrs after that.		
Drain or preserve fuel	Before prolonged storage		
Fog or lube cylinder	Before prolonged storage		
Rotate engine to TDC	Before prolonged storage		

Frequently used specifications

	Minimum		Maximum	
	in.	mm	in.	mm
Intake valve lash				
78	0.004	0.10	0.006	0.15
83	0.004	0.10	0.006	0.15
90	0.004	0.10	0.006	0.15
Exhaust valve lash				
78	0.006	0.15	0.008	0.20
83	0.006	0.15	0.008	0.20
90	0.006	0.15	0.008	0.20
Spark plug gap				
78	0.026	0.65	0.030	0.75
83	0.026	0.65	0.030	0.75
90	0.026	0.65	0.030	0.75
Module air gap				
78	0.016	0.40	0.024	0.60
83	0.016	0.40	0.024	0.60
90	0.016	0.40	0.024	0.60
Displacement				
78	16.9 cid (277 cc)			
83	21.8 cid (357 cc)			
90	25.6 cid (420 cc)			
Governed engine RPM				
78	3500 ± 100			
83	3500 ± 100			
90	3500 ± 100			
Oil capacity				
78	37 oz	1.1 L		
83	37 oz	1.1 L		
90	37 oz	1.1 L		
Fuel tank capacity				
78	1.3 gal	5.0 L		
83	1.3 gal	5.0 L		
90	1.3 gal	5.0 L		

For Parts Call 606-678-9623 or 606-561-4983

78/83/90 Series Horizontal Shaft Engines

CHAPTER 2: BASIC TROUBLESHOOTING

Definitions

Troubleshooting - The act of gathering information by performing tests and direct observations.

Diagnosis - Developing and testing theories of what the problem is, based on the information gathered in troubleshooting.

Introduction

Diagnosing an engine is an art form that is built upon several factors. First and most importantly is a good understanding of how the engine works. The second is skills that have been honed by experience. Finally the use of visual observations and a structured, systematic approach to troubleshooting a problem.

The first part of this chapter will outline the steps of troubleshooting an engine so a technician can form a proper diagnosis. The second half of this chapter will describe specific procedures and tests to perform while troubleshooting.



The first two rules in troubleshooting is to cause no further harm to the engine and prevent injuries. Always make sure to check the oil for level and condition before starting an engine. Also check attachments for damage and make sure they are firmly mounted.

Steps to troubleshooting

NOTE: The steps and the order of the steps that follow are a suggested approach to troubleshooting the MTD engine. The technician does not necessarily have to follow them as described in this chapter

Define the problem

The first step in troubleshooting is to define the problem:

- Crankshaft will not turn.
 - A. Hard to pull rope, steady pressure
 - B. Rope jerks back
 - C. Rope will not pull at all
- Crankshaft turns, no start
- Starts, runs poorly
 - A. Starts, then dies
 - B. Runs with low power output
 - C. Makes unusual smoke when running
 - I. Black smoke, usually heavy
 - II. White smoke, usually heavy
 - III. Blue smoke. usually light
 - D. Makes unusual sounds when running
 - I. Knock
 - II. Click
 - III. Chirp

78/83/90 Series Horizontal Shaft Engines

IV. Unusual exhaust tone

There are tools that the technician can use in order to define the problem, such as:

1. Interview the customer.
 - 1a. Get a good description of their complaint.
 - 1b. If it is an intermittent problem, verify what conditions aggravate the problem as best as possible.
 - 1c. Get an accurate service history of the equipment.
 - 1d. Find out how the customer uses and stores the equipment.
2. Direct observation:
 - 2a. Do not automatically accept that the customer is correct with their description of the problem. Try to duplicate the problem.
 - 2b. Check the general condition of the equipment (visually).
 - I. Cleanliness of the equipment will indicate the level of care the equipment has received.
 - II. Make sure the engine and attachments are securely fastened.
 - III. The tune-up factors.

NOTE: Most hard starting and poor running conditions can be solved by performing a tune-up.

 - a. Check the condition and amount of oil in the crankcase.
 - b. Check the level and condition of the fuel.
 - c. Check the ignition and “read” the spark plug.
 - d. Look for obvious signs of physical damage, exhaust system blockage or cooling system blockage.
3. Broken starter rope.
 - 3a. Usually means the engine was hard to start.
 - 3b. Makes it impossible to confirm any running or hard starting symptoms by direct observation.
 - 3c. Some inference can be made from checking other factors of the general condition of the equipment.

Identify factors that could cause the problem

This is the second step in the troubleshooting process.

1. Crankshaft will not turn.
 - A. Hard to pull rope, steady pressure. This usually indicates a mechanical bind of some sort. The likely suspects are:
 - I. A slightly bent crankshaft. In some cases the drag may increase and decrease as the crankshaft rotates. This produces a pulsing feeling that is different than a jerk back.
 - II. A parasitic load from a drive belt that is not releasing or an implement that is jammed.
 - III. An internal drag from a scored or seized piston.

- D. Rope jerks back. This usually indicates that the piston is stopping before top dead center on the compression stroke and is being driven back down by compression or combustion. The likely suspects are:
- I. Compression that is unusually high.
 - a. valve lash.
 - b. a partial hydraulic lock.
 - III. Ignition timing is advanced.
 - a. Improper air gap.
 - b. Sheared or missing flywheel key.
 - c. The wrong flywheel or module is installed on the engine.
 - IV. Insufficient inertia to over-come normal compression.
 - a. Loose implement.
 - b. A light flywheel used on a heavy flywheel application.
- C. Rope will not pull at all. This is usually either a quick fix or a catastrophic failure. The likely suspects are:
- I. A broken starter recoil (easy fix).
 - II. Complete hydraulic lock (easy fix).
 - III. External binding/jammed implement (easy fix).
 - IV. Bent crankshaft (unrepairable)
 - V. Internal binding, crankshaft, connecting rod or piston (unrepairable)
2. Crankshaft turns, no start.
- 2a. Most gasoline engine diagnosis involves isolating problems in the four critical factors an engine needs to run properly:
- I. Ignition- sufficient spark to start combustion in the cylinder, occurring at the right time.
 - II. Compression- enough pressure in the cylinder to convert combustion into kinetic motion. It also needs sufficient sealing to generate the vacuum needed to draw in and atomize the next intake charge.
 - III. Fuel- correct type and grade of fresh gasoline; in sufficient quantity, atomized (tiny droplets) and in correct fuel/air proportions.
 - IV. Flow- if all of the above conditions are met but the flow of air is constricted on the inlet or exhaust side, it will cause the engine to run poorly or not at all. This also includes ensuring the valves are timed to open at the proper time.
- 2a. Isolate the ignition system and compression from the fuel system by performing a prime test.
- I. Burns prime and dies. This would indicate a fuel system issue.
 - II. Does not burn prime. Not a fuel system issue. Check for an ignition, compression or flow problem.
- 2c. Compression or ignition problem
- I. Check the engine stop and safety switch.
 - II. Test the ignition system using a proper tester.
 - III. Replace the spark plug with a new one or a known good one.
 - IV. Check compression or leak down.
 - V. Check valve lash.

78/83/90 Series Horizontal Shaft Engines

VI. Check valve timing/actuation.

VII. Check exhaust.

3. Starts, runs poorly

3a. Starts, then dies

I. Run the engine with a spark tester in-line between the spark plug wire and the spark plug or use an oscilloscope and see if the spark goes away at the same time the engine dies.

II. Check choke operation.

a. Black smoke?

b. Wet plug?

III. Prime test immediately after engine dies. If it restarts; this may indicate a problem with fuel flow to the carburetor. Check the gas cap, fuel line, fuel filter, and the float in the carburetor.

3b. Runs with low power output.

I. Look for unusual exhaust color (smoke).

II. Unusually hot muffler (may glow red).

a. Retarded ignition

b. Exhaust valve opening early (lash too tight)

III. Mechanical bind

a. A slightly bent crankshaft. In some cases the drag may increase and decrease as the crankshaft rotates. This produces a pulsing feeling that is different than a jerk back.

b. Parasitic external load. A bind in the equipment the engine is powering.

c. Internal drag from a scored piston or similar damage.

IV. Low governor setting or stuck governor.

a. Check RPMs using a tachometer.

b. RPMs should not droop under moderate to heavy loads.

V. Low compression

a. Check valve lash

b. Check compression

c. Check leak down to identify the source of the compression loss.

VI. Flow blockage

a. Exhaust blockage, usually accompanied by an unusual exhaust sound.

- Just as a throttle on the carburetor controls the engine RPMs by limiting the amount of air an engine can breathe in, an exhaust blockage will limit engine performance by constricting the other end of the system.

- The muffler itself may be blocked.

- The exhaust valve may not be opening fully, possibly because of extremely loose valve lash settings.

- The exhaust valve seat may have come loose in the cylinder head. This may cause a loss of compression, a flow blockage or it may randomly alternate between the two.

NOTE: The cause of an exhaust valve coming loose is usually over heating.

- b. Intake blockage
 - An intake blockage up-stream of the carburetor will cause a rich fuel/air mixture and constrict the amount of air that the engine can draw in, limiting performance.
 - The intake valve not fully opening. A possible cause of this is loose valve lash.
- V. Makes unusual smoke when running
 - a. Black smoke, usually heavy, usually indicates a rich air fuel mixture
 - Not enough air: air flow blockage or a partially closed choke.
 - Too much fuel: carburetor float or float valve stuck or metering / emulsion issues with the carburetor.
 - b. White smoke, usually heavy
 - Oil in muffler, usually the result of improper tipping. The engine will “fog” for a minute or so, then clear-up on its own.
 - Massive oil dilution with gasoline. It may be caused by improper tipping. It can also be caused by leaky carburetor float valve, if there is a down-hill path from the carburetor to the intake port. Check oil for gasoline smell, repair carburetor.
 - c. Blue smoke, usually light.
 - PCV system
 - May be blocked or unplugged.
 - May be over-come by massive over-filling or oil dilution with gasoline.
 - Will cause oil to exit the engine via any low-resistance paths.
 - Piston rings
 - Confirm with leak-down test.
 - Smoke will be more pronounced under load.
 - Repair may not make economic sense.
 - Valve guides (and intake valve stem seal).
 - Smoke will be more pronounced on over-run.
- VI. Makes unusual noise when running
 - a. Knock
 - Check for loose mounting of engine or driven implement
 - Rotate crankshaft back-and-forth to check for loose connecting rod.
 - b. Click
 - Clicks and pops on engine shut-down: Compression release coming into play as the engine RPMs cross the activation threshold. This will have no ill effects on engine performance.
 - Half-engine speed clatter: loose valve lash.
 - Half-engine speed clatter, slightly heavier: wrist-pin.
 - Rhythmic heavy-light engine speed click: piston slap
 - c. Spark-knock
 - Advanced ignition timing

78/83/90 Series Horizontal Shaft Engines

- Low octane fuel
- Over-heating engine (check for blocked cooling air flow)
- Carbon build-up in cylinder: glowing carbon chunks pre-igniting air fuel mix.

d. Chirp

- Compression, blowing-by the fire-ring of a damaged head gasket will sometimes produce a chirping noise.
- Confirm with a compression test and leak-down test.

e. Unusual exhaust tone

Splashy or blatty

- Splashy idle usually indicates a slight rich condition.
- May indicate an exhaust blockage, usually slightly muffled.

Backfire

- On over-run: unburned fuel igniting past exhaust valve. Mixture not burning completely in combustion chamber. It may be too rich or it may be spark-plug or ignition problem.
- Occasional, under load: engine momentarily runs lean, usually will cycle with float bowl level or governor pull-in, sometimes sounds like a slight stumble. Ethanol content exceeding 10% will make the engine run artificially lean.

Skip

- Usually ignition related.
- Run the engine with a spark tester in-line between the spark plug wire and the spark plug or use an oscilloscope and see if the spark goes away at the same time the engine dies.

4. Engine over-speed

A. Continual over-speed

- Binding or damaged external governor linkage or carburetor throttle.
- Mis-adjusted governor arm.
- Internal governor failure.

B. Momentary over-speed

- Intermittent bind (very unusual).
- Interference: This is fairly common when debris can fall on the governor linkage during normal operations.

5. Engine RPMs surge (hunting)

A. Over-governed condition- Return spring replaced with wrong part or hooked into wrong hole.

NOTE: This is an extremely rare condition, usually created by tampering.

B. Lean Air-fuel mixture condition- When AFR (Air Fuel Ratio) is significantly below stoichiometric ratio (14.7:1) engine RPMs sink until they reach a point that can be supported by the available fuel. This causes a momentary surge in power until the available fuel is consumed, then the RPMs fall again, repeating the cycle.

- Too much air: look for an air leak in the intake tract
- Not enough fuel: look for fuel supply or carburetor problems

Repairing the problem

The third step in the troubleshooting process is to repair the problem. This step consists of:

- A. Form a diagnosis by using all of the information gathered from the troubleshooting that was performed.
- B. Physically perform the repair.

The fourth, and hopefully final, step in the troubleshooting process is the follow through. This step consists of:

- A. Thoroughly test the repaired equipment: confirming that the initial diagnosis was correct. If it was wrong, start the troubleshooting process over again.

NOTE: Sometimes the engine will have multiple problems at the same time. By performing one repair, other issues may show up that are unrelated to the first repair.

- B. Delivery to customer: We are not just repairing equipment, we are repairing customers.
 - Inoculate against recurring problem with education, e.g.: if the problem was caused by stale fuel, make sure the customer is aware that fuel goes bad over time.
 - Make sure the customer understands the repair, preventing “superstitious” come-backs.

78/83/90 Series Horizontal Shaft Engines

Prime test

To perform a prime test:

1. Prime the engine through the carburetor throat using a squirt bottle, filled with clean fresh gasoline.
2. Make sure the throttle is in the run position and the safety key is fully inserted.
3. Attempt to start the engine.
4. If the engine starts and runs long enough to burn the prime, the problem is effectively isolated to the fuel system. proceed to Chapter 4: The Fuel System and Governor.
5. Check ignition system as described in Chapter 7: Ignition System.
6. If the ignition system is working, check the compression or perform a leak down test.

Leak-down test

A leak-down test is the preferred method to test the engine's ability to compress the charge. It will also show where pressure is leaking from.

To perform a leak-down test:

NOTE: A leak down test pressurizes the combustion chamber with an external air source and will allow the technician to listen for air "leaking" at the valves, piston rings and the head gasket.

NOTE: These are general instructions. Read and follow the instructions that came with the tester before attempting to perform this test.

- If possible, run the engine for 3-5 minutes to warm up the engine.
- Remove the spark plug and air filter.
- Find top dead center of the compression stroke.



If the engine is not centered at top dead center, the engine will rotate when compressed air is introduced to the combustion chamber.

1. Find top dead center by following the steps described in the valve lash section of Chapter 1: Introduction
 2. Thread the leak down tester adapter into the spark plug hole. See Figure 2.1.
 3. Connect tester to compressed air.
 4. Adjust the regulator knob until the needle on the gauge is in the yellow or set area of the gauge.
 5. Connect the tester to the adapter.
- NOTE:** If the engine rotates it was not at top dead center.
6. Check the reading on the gauge.

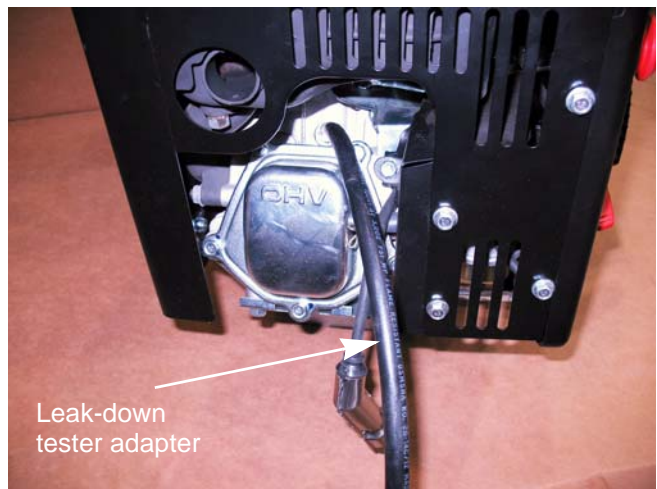

Figure 2.1

7. Compare the results to the following chart.

Leak-down Testing Results

Symptom	Possible cause
Air escaping from the breather	Worn cylinder or piston rings. Possible blown head gasket
Air escaping from the exhaust	Leaking exhaust valve
Air escaping from the carburetor	Leaking intake valve
Gauge reading low	Cylinder and piston rings are in good condition
Gauge reading moderate	There is some wear in the engine, but it is still usable
Gauge reading high	excessive wear of cylinder and/or piston rings. Engine should be short blocked or it could be a blown head gasket.

78/83/90 Series Horizontal Shaft Engines

Compression test

To perform a compression test:

NOTE: Compression should be in the range of 40-75 PSI (2.8-5.2 Bar).

- Disconnect the high-tension lead from the spark plug and ground it well away from the spark plug hole.
- Remove the spark plug using a 13/16" or 21mm wrench. A flexible coupling or "wobbly" extension may help.
- Pull the starter rope several times to purge any fuel or oil from the combustion chamber.

NOTE: Air compresses readily, liquid does not. Liquid in the combustion chamber will result in an artificially high compression reading.

1. Install a compression gauge in the spark plug hole.
2. Confirm that the gauge is "zeroed", then pull the starter rope repeatedly, until the needle on the gauge stops rising. See Figure 2.2.



Figure 2.2

3. Interpreting compression readings.

Compression Readings

Readings in psi	Possible causes
<20 (1.4 Bar)	Most likely a stuck valve or too tight of a valve lash, provided the starter rope pulls with normal effort.
20 - 40 (1.4-2.8 Bar)	Valve seat damage or piston ring and/or cylinder wear.
40 - 75 (2.8-5.2 Bar)	Normal readings
>75 (>5.2 Bar)	Excessive valve lash, a partial hydraulic lock, a bad cam or a bad automatic compression relief.

PCV testing

The PCV (Positive Crankcase Ventilation) valve is located in the valve cover and allows the crankcase pressure to escape.

Leakage and blockage are the two failure modes for a PCV system. Either mode will cause crankcase pressure to build-up, though the effects of a blocked PCV are generally more dramatic. Increased case pressure will result in oil entering the combustion chamber.

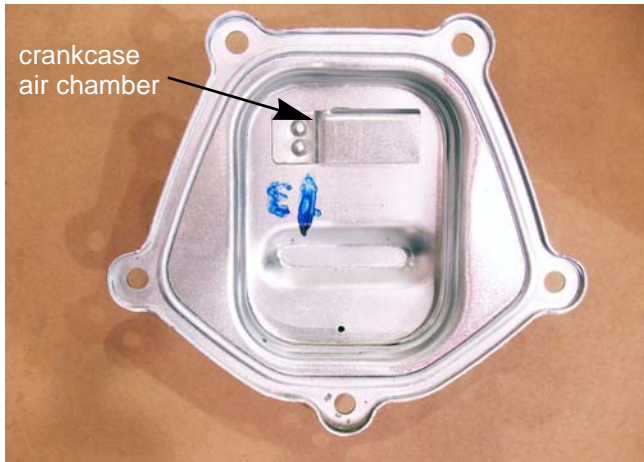

Figure 2.3

1. The PCV chamber is vented to the heat box through a molded rubber hose. The rubber hose directs crankcase fumes to the heat box assembly. See Figure 2.3.
2. When functioning properly, the PCV valve works with the inherent pumping action of the piston in the bore to expel pressure from the crankcase.

NOTE: Normally, small engines run with slightly negative case pressure. This case pressure can be measured using a slack-tube water manometer, or an electronic version of the same tool. Less than -3" to -4" (-7.6 - 10.2cm) of water is a typical reading at idle.

3. An engine that fails to purge extra case pressure in a controlled manner will build case pressure. The pressure will find it's own way out of the engine in undesirable ways.

- Oil will be forced by the rings and valve guides, being burnt in the combustion chamber.
 - The cause of this oil burning can be mistaken for a worn-out engine, if proper diagnosis (compression, leak-down, and case pressure) is not performed.
4. Experimentation by MTD's Training and Education Department has revealed the following characteristics of MTD engines:
 - A leaky PCV system will not build-up substantial case pressure.
 - A leaky PCV system will allow the engine to ingest contaminants through the system, accelerating engine wear.
 - A blocked PCV system will allow crankcase pressure to build very rapidly. Noticeable oil fumes will be evident in the exhaust within several minutes of normal operation.

For Parts Call 606-678-9623 or 606-561-4983

78/83/90 Series Horizontal Shaft Engines

CHAPTER 3: AIR INTAKE SYSTEMS

MTD builds horizontal crank engines for snow blowers and chore performers. The differences between snow engines and chore engines are the muffler and the air intake system. Therefore the air intake system for the snow and chore engines will be discussed separately, as will the mufflers in a later chapter.

Heat box (snow engines)

One of the big differences between snow engines and all other small engines is that the air intake of the snow engine does not have an air filter. This is because air filters tend to freeze, cutting off air flow to the engine. The snow engine however does have a heat box to preheat the intake air.

The bottom of the heat box is open to draw in a large volume of cold air. The top of the heat box has a small opening where the choke rod connects to the carburetor. This draws in just enough warm air from the top of the engine to heat the cold air to the desired temperature as it enters the carburetor.

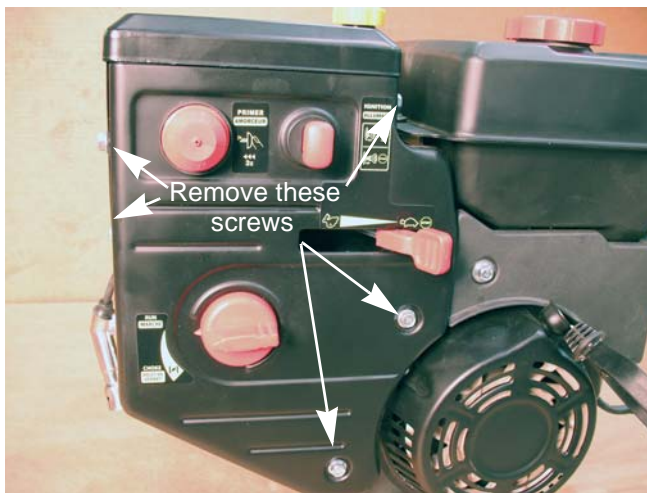

Figure 3.1

To remove/replace the heat box:

1. Pull off the choke and throttle knobs.
2. Remove the control panel by taking off the five screws secures it using a 10 mm wrench. See Figure 3.1.

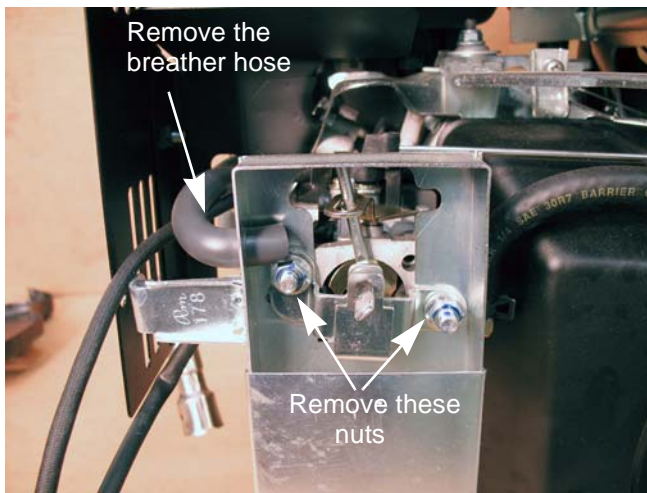

Figure 3.2

3. Disconnect the wire from the ignition switch and the primer line from the primer button.
4. Slide the breather hose out of the heat box. See Figure 3.2.
5. Remove the two carburetor nuts using a 10 mm wrench. See Figure 3.2.

NOTE: When installing, tighten the carburetor nuts to a torque of 80 - 106 in-lbs. (9-12 Nm)

6. Remove the choke selector assembly.
7. Slide the heat box off of the carburetor studs.
8. Install the heat box by following the previous steps in reverse order.

NOTE: There is no gasket between the heat box and the carburetor.

78/83/90 Series Horizontal Shaft Engines

Air filter (summer engines)

Generally air filters come in two different types, a pleated-paper element or foam. A combination of the two are used on the MTD engine.

- Air filters used on the MTD engine are designed to prevent particles larger than 3-5 micron from passing through into the engine.
- The filter should be checked on a regular basis possibly several times in a season.

NOTE: Never use compressed air on a paper air filter. Compressed air will remove the tiny fibers that are used to catch the dirt in the air. Without these fibers the filter is useless.

NOTE: Refer to Chapter 1: Introduction for the maintenance interval and cleaning instructions for the air filter.

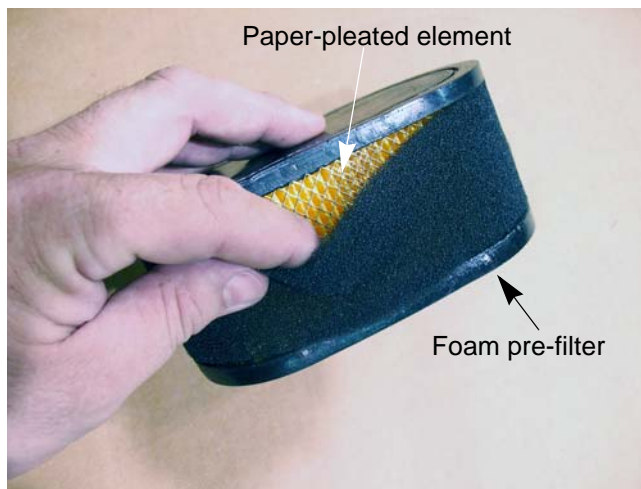

Figure 3.3

To replace an air filter:

1. Wipe down the air filter housing to prevent any debris from getting into the engine.
2. Unthread the two wing nuts in the air filter cover. See Figure 3.4.

NOTE: The wing nuts are part of the filter housing and do not come off.



Figure 3.4

3. Swing the housing away from the fuel tank. See Figure 3.5.
4. Remove the air filter assembly.



Figure 3.5

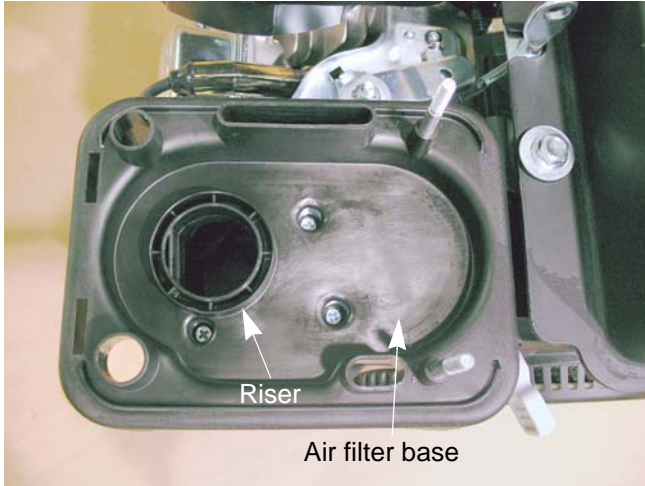

Figure 3.6

5. Install the air filter by following the previous steps in reverse order.

NOTE: When installing the air filter, the hole in the bottom of the paper element must fit over the riser in the air filter base. See Figure 3.6.

78/83/90 Series Horizontal Shaft Engines

Air filter base and control panel (summer engines)

To remove/replace the air filter base and control panel:

1. Remove the air filter following the steps described in the previous section.
2. Remove the three screws that hold the air filter base to the intake elbow. See Figure 3.7.

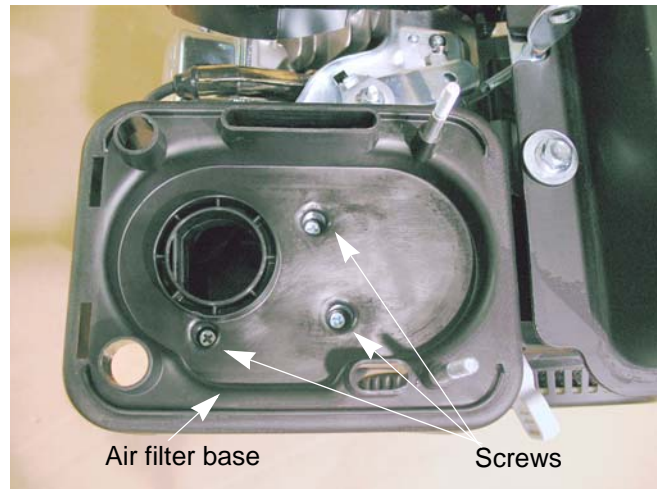

Figure 3.7

3. Pull off the throttle lever knob. See Figure 3.8.
4. Remove the two carburetor nuts using a 10 mm wrench.
5. Remove the bolt from the front of the control panel using a 10 mm wrench.
6. Align the throttle lever, choke lever and the fuel shut-off lever in the middle of their slots.

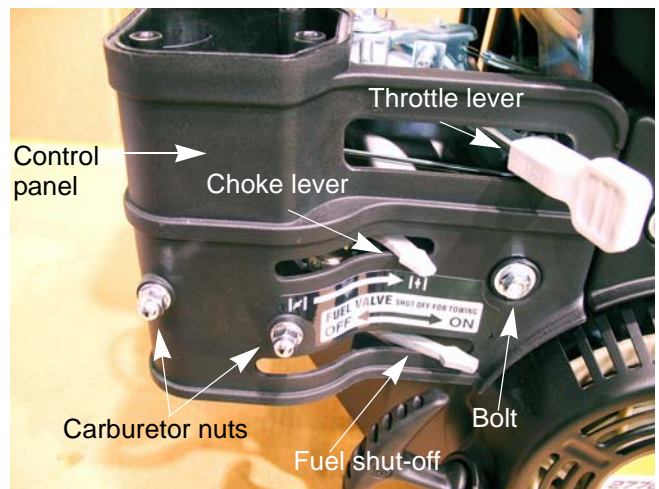

Figure 3.8

7. Remove the bolt that holds the rear of the control panel to the throttle bracket. See Figure 3.9.
8. Disconnect the breather hose.

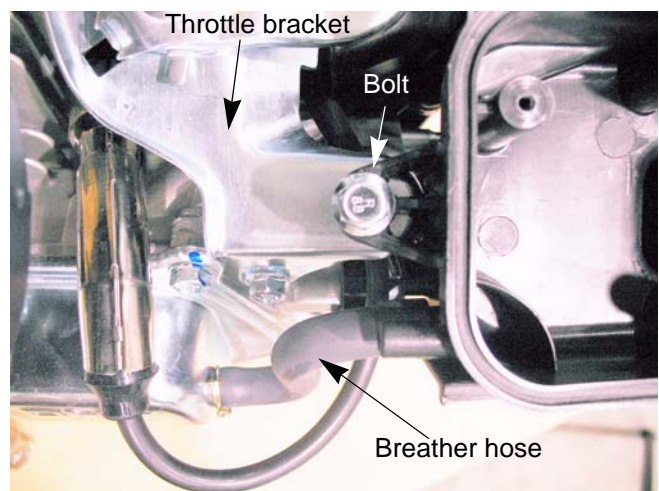

Figure 3.9

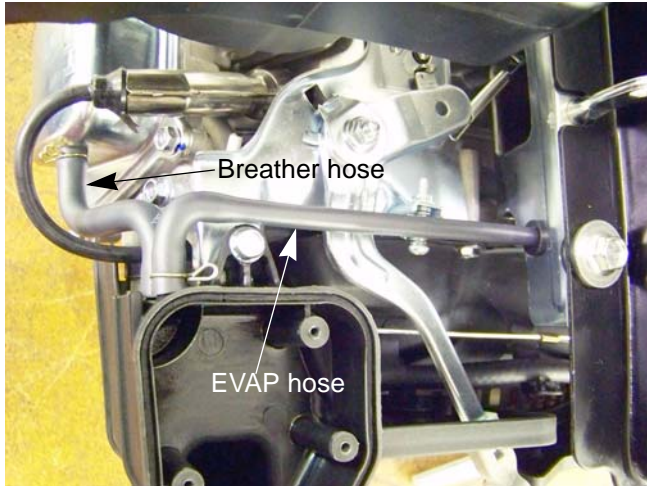

Figure 3.10

NOTE: All summer engines built on or after January 1, 2011 will have a hose from the evaporative emissions (EVAP) system attached to the control panel above the breather hose. See Figure 3.10.

9. Pull the control panel straight off the front of the engine.
10. Install the control panel by following the previous steps in reverse order.

NOTE: tighten the carburetor nuts to a torque of 80 - 106 in lbs (9 - 12 Nm).

11. Test run the engine before returning it to service.

78/83/90 Series Horizontal Shaft Engines

Carburetor and Insulator

1. Siphon the fuel out of the fuel tank.



To avoid personal injury or property damage, use extreme care in handling gasoline. Gasoline is extremely flammable and the vapors are explosive. Keep away from sources of ignition.

Serious personal injury can occur when gasoline is spilled on yourself and/or your clothes which can ignite. Wash your skin and change clothes immediately

NOTE: Dispose of drained fuel in a safe and responsible manner.

2. Remove the fuel tank front bezel using a 10 mm wrench. See Figure 3.11.

NOTE: The bezel may get stuck on the cup for the recoil starter. If it does, the recoil starter is easily removed with an 8 mm wrench.

3. Disconnect the fuel line from the fuel tank. See Figure 3.12.



Residual fuel in the fuel tank will come out when the fuel line is removed. Wear safety goggles to help prevent gasoline from splashing into your eyes.

Residual fuel in the fuel tank will come out when the fuel line is removed. Wear safety goggles to help prevent gasoline from splashing into your eyes.



Figure 3.11



Figure 3.12

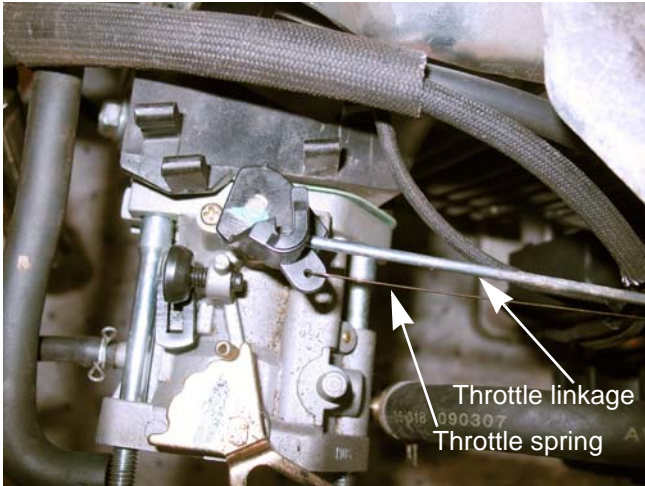

Figure 3.13

4. Remove the Heat box (snow engines) or the control panel (summer engines) by following the steps described in appropriate section of this chapter.
5. Disconnect the throttle linkage and spring. See Figure 3.13.
6. Slide the carburetor off of the mounting studs.
7. Remove the carburetor.

NOTE: The barb on the carburetor inlet is very sharp. If the fuel line is pulled off of it, the line will be damaged and must be replaced.

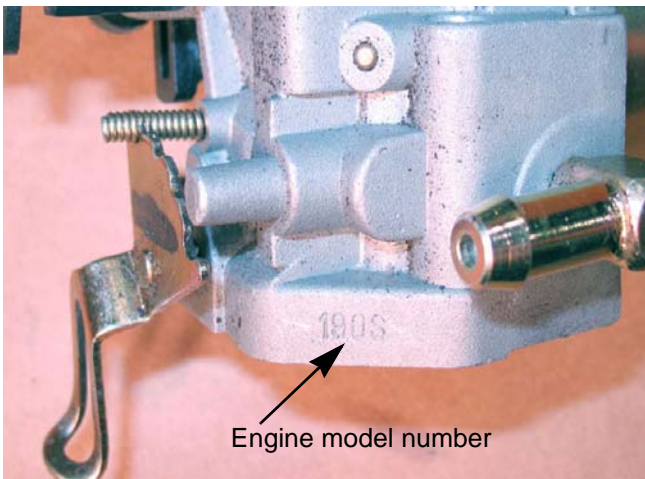

Figure 3.14

NOTE: The carburetors are not inter-changeable from one engine model to another. To help prevent carburetor mix-ups, the engine model number is stamped on the carburetor by the fuel nipple. See Figure 3.14.

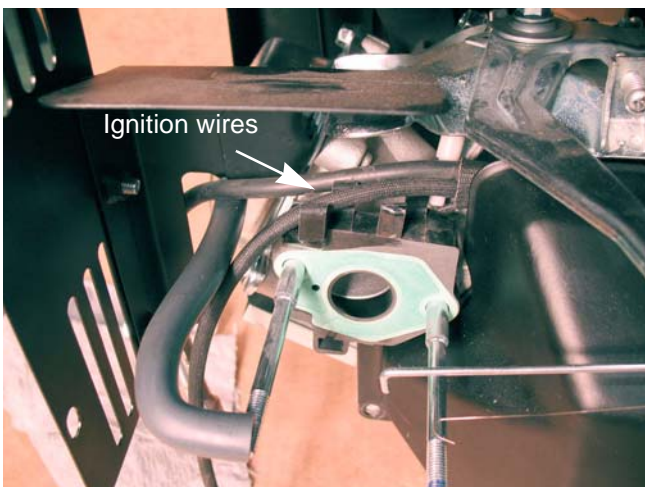

Figure 3.15

8. Unhook the ignition wires from the clip molded into the insulator plate. See Figure 3.15.

78/83/90 Series Horizontal Shaft Engines

NOTE: An insulator block separates the carburetor from the cylinder head. There is a gasket on each side of the insulator. See Figure 3.16.

NOTE: The gaskets are different, and there is an orientation to the insulator.

- The bowl vent channel in the insulator faces the carburetor, with the exit toward the bottom.
- There is a small hole in the insulator to carburetor gasket. The hole should be aligned to allow passage of air through the bowl vent channel to the throttle side bowl vent in the carburetor body.

9. Install the insulator and carburetor by following the above steps in reverse order.

NOTE: Tighten the carburetor mounting nuts to a torque of 80 - 106 in-lbs (9-12 Nm).

10. Test run the engine before returning to service.

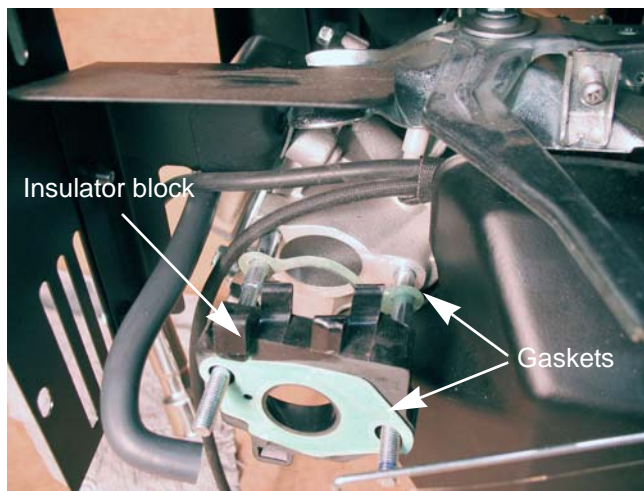

Figure 3.16

CHAPTER 4: THE FUEL SYSTEM AND GOVERNOR

The function of the fuel system is to store fuel, mix the fuel with air in the correct ratio and deliver it to the intake port. The fuel system consists of the following components:

- Fuel tank
- Fuel lines
- Fuel filter
- Carburetor

NOTE: When working on the fuel systems, look at the whole system. A problem will rarely be isolated to one component.

Inspecting the fuel

NOTE: Fuel is the maintenance item most often overlooked by consumers. A lot of fuel systems problems are caused by gas that is out of date or fuel with too much alcohol in it. When inspecting the fuel:

- Look for water.
- Look for dirt.
- Look for discoloration.
- Sniff carefully to see if it smells like varnish or kerosene.
- Save the fuel to show to customer.
- Look for oil in the fuel.
- Test the fuel for alcohol content if there is a reason to suspect it.

NOTE: Save a sample of the fuel collected to show the customer.

NOTE: Customers pouring engine oil into the fuel tank seems to be a growing problem.

78/83/90 Series Horizontal Shaft Engines

Test fuel for alcohol

Fuels currently on the market contain a wide array of additives. Some of these additives oxygenate the fuel. Oxygenated fuel reduces emissions, and is required in some parts of the United States. Fuel make-up varies seasonally and geographically. Ethanol is the primary additive used to oxygenate fuel.

Ethanol in fuel creates a lot of problems for gasoline engines. The biggest problem is that alcohol attracts and holds water. This corrodes the metal components of the fuel system, especially the carburetor. Alcohol also does not produce as much heat as gasoline when burnt. This results in less power for the engine.

A 10% ethanol (E10) mix is acceptable for MTD engines. Anything higher than that will result in performance issues.

NOTE: E20 and E85 fuels are not to be used in any MTD engines.

There are several alcohol test kits available commercially. See Figure 4.1.



Figure 4.1

Generally these kits involve mixing a measured amount of water and gas together and seeing where the boundary layer is. See Figure 4.2.

The test kit should come with a chart to compare the boundary layer height to alcohol percentage.



Figure 4.2

Fuel tank vent

The fuel tank vent performs the important task of allowing air into the fuel tank. As fuel is being used by the engine, the fuel level in the tank drops. The dropping fuel level then creates a vacuum in the tank. If the fuel tank could not draw air through the vent, the vacuum would prevent the fuel from getting to the carburetor. The vent is located in the fuel cap. See Figure 4.3.

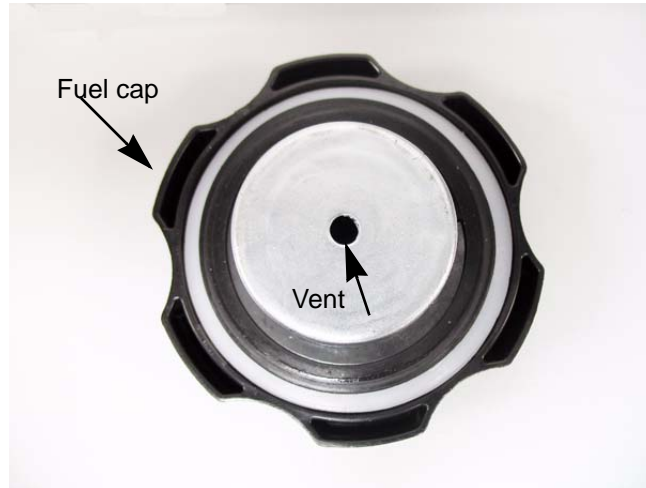

Figure 4.3

NOTE: All summer engines built on or after January 1, 2011 will have an evaporative emissions (EVAP) system that the fuel tank vents through, not the fuel cap. Refer to the evaporative emissions section of this chapter to understand how this system works and how to test it.

To test the cap vent:

1. Remove the fuel cap.
2. Clean off the vent.
3. Blow air into the vent hole. The air should blow through the vent with little back pressure.
4. Suck air through the vent hole. Air should freely enter through the vent.
 - Replace the cap if the vent builds pressure or restricts air movement.
 - A cap that maintains pressure will cause the engine to run rich as the fuel in the tank heats and expands, forcing it's way past the float valve in the carburetor.
 - A cap that maintains vacuum will cause the engine to run lean as the fuel is depleted and no air comes in to replace it.
 - The two conditions may both be present, but the symptoms vary with fuel, fuel level, and operating conditions.
 - A bad fuel cap vent usually presents as a "Runs and quits" scenario.

78/83/90 Series Horizontal Shaft Engines

The fuel filter

The fuel filter is located in the fuel tank nipple. It can be removed and cleaned with a can of carb cleaner or it can be replaced. See Figure 4.4.

NOTE: If cleaning a filter, back-flush it by spraying the carb cleaner through the barb end and out of the screen. Also make sure the fuel tank is clean.

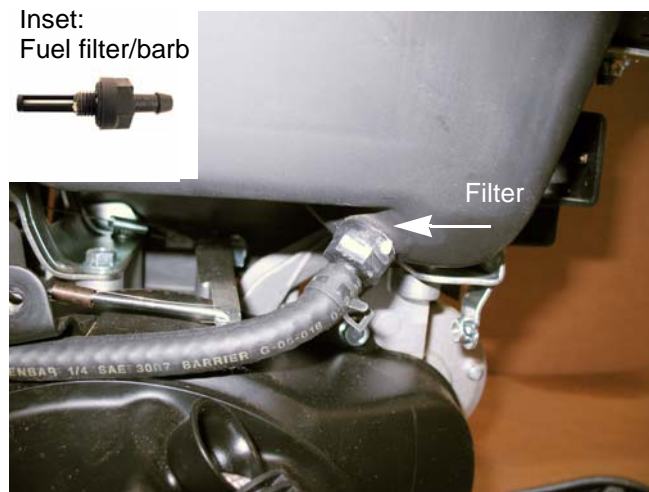

Figure 4.4

NOTE: To replace the fuel filter follow the steps described in Chapter 1: Introduction.

Inspect the fuel lines

- Are they cracked?
- Are they clogged?
- Are they brittle?

NOTE: If the answer to any of the above is yes, replace the fuel lines. When replacing fuel lines, low permeable fuel line must be used in order to meet EPA and CARB standards.

NOTE: The nipple has a sharp edge that will damage the inner lining of the fuel line. Replace the fuel line every time it is removed from the carburetor fuel nipple.



WARNING Gasoline is extremely flammable and the vapors are explosive. Avoid all sources of heat when working on the fuel system.

- Drain the fuel tank before starting work to prevent spillage.
- Dispose of drained fuel in a safe and responsible manner.

The fuel tank



Figure 4.5

To remove the fuel tank:

1. Drain the tank.
2. Remove the four screws that secure the fuel tank using a 12 mm wrench. See Figure 4.5.

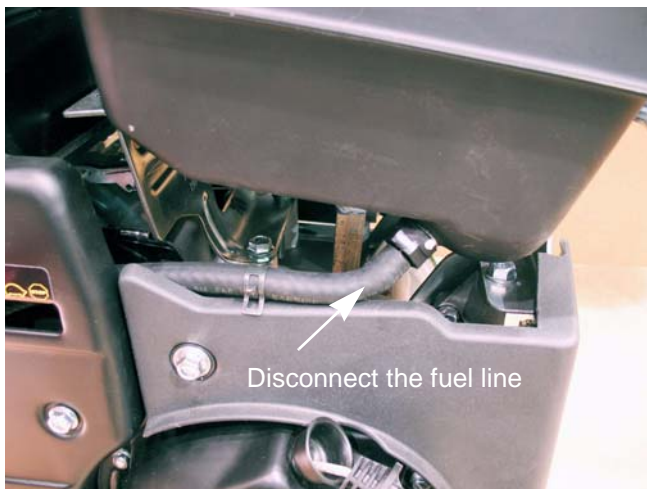

Figure 4.6

3. Lift up on the fuel tank and disconnect the fuel line. See Figure 4.6.



Figure 4.7

NOTE: On engines equipped with an EVAP system, disconnect the hose from the roll over valve. See Figure 4.7.

4. Install the fuel tank by following the above steps in reverse order.

78/83/90 Series Horizontal Shaft Engines

Evaporative (EVAP) emissions system

Gasoline is made from the graduated distillation of crude oil. It consists of a multitude of individual hydrocarbons and has a boiling range of 86 - 410°F (30-210°C)¹. The large quantity of hydrocarbons and the low boiling range makes gasoline an ideal fuel for spark ignited, internal combustion engines. However, the hydrocarbons are not good for the environment. To reduce or eliminate the release of fuel vapors into the atmosphere, an evaporative (EVAP) emissions system is used.

Effective January 1, 2011; the EPA has mandated that all summer engines with 225cc's of displacement or more must be equipped with an evaporative emissions system.

The EVAP system used by MTD consists of:

- A charcoal canister
- The fuel tank and cap
- A roll over valve vent
- The control panel.
- Vacuum lines

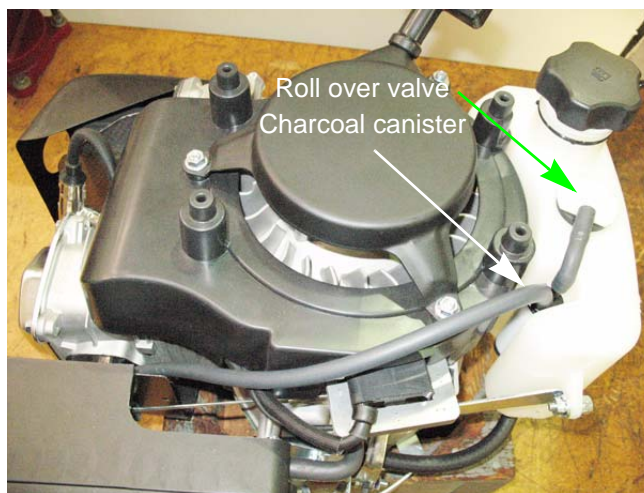

Figure 4.8

Reference

1. Dr. Ullmann, J, Fuels, *Automotive Handbook*, seventh edition. Bosch, Robert distributed by SAE Society of Automotive Engineers, 2007. 320.

FUEL SYSTEM AND GOVERNOR

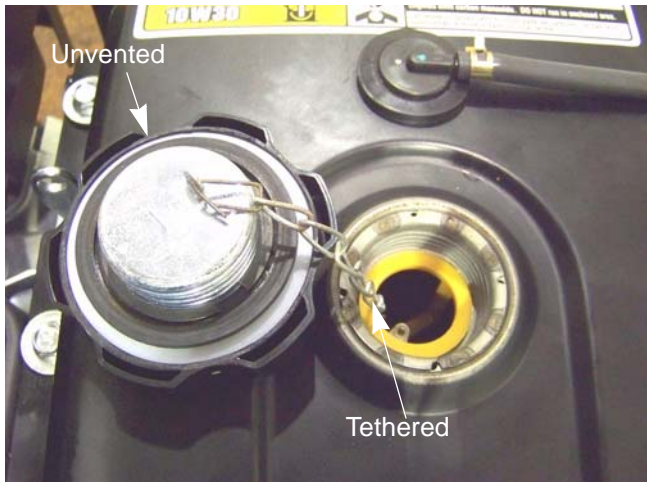

Figure 4.9

This system operates as follows:

1. The gasoline evaporate and lets off vapors.
2. The vapors exit the fuel tank through the roll over valve vent.

NOTE: The fuel cap used with the charcoal canister system is not vented. If a vented cap is used, the EVAP system will not work. See Figure 4.9.

NOTE: The new EPA standard also requires the fuel caps to be tethered to the fuel tank.

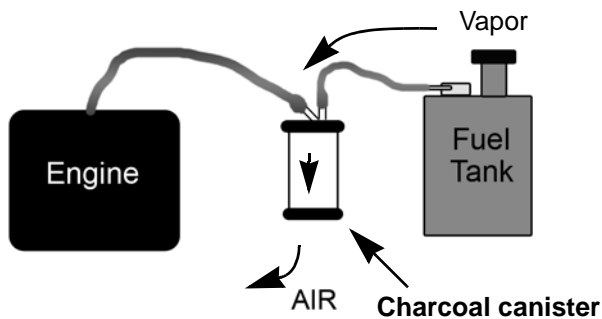

Figure 4.10

3. The vapors are routed through the charcoal canister. See Figure 4.10.

4. The activated charcoal inside the canister absorbs the hydrocarbons allowing the air to pass through and out to the atmosphere.

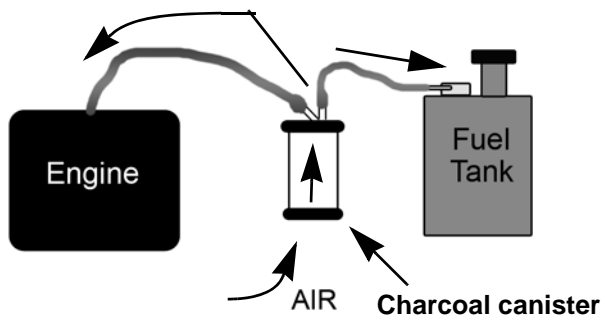

Figure 4.11

5. The second line on the charcoal canister goes to the control panel. When the engine is running, vapors are drawn out of the charcoal canister by the air being drawn into the carburetor. This re-charges the canister of the next down period. See Figure 4.11.

78/83/90 Series Horizontal Shaft Engines

Troubleshooting the EVAP System

There are four failure modes for the EVAP system:

- A leak in the system - will allow dirt ingestion.
- A blockage in the system (between the canister and the fuel tank) - acts a plugged vent.
- A blockage in the system (between the canister and the control panel) - The canister can not purge its vapors.
- Charcoal canister poisoned (raw fuel in the canister) - prevents the canister from absorbing fuel vapors.

NOTE: The only failure mode that will affect the operation of the engine in a way the operator will notice is a blockage in the system.

To test the system for a blockage:

1. Remove the fuel cap.
2. Clamp off the hose that runs from the canister to the control panel. See Figure 4.12.



Figure 4.12

3. Attach a vacuum pump to the vent port of the charcoal canister. See Figure 4.12.
4. Apply a vacuum to the canister.

NOTE: When applying the vacuum, squeeze the pump slowly. Too much vacuum can close the roll over valve giving a false reading.

5. If the canister does not hold a vacuum, the canister and the roll over valve are working properly.

NOTE: If the canister does hold a vacuum, test the roll over valve to determine if the roll over valve or the canister is at fault.



Figure 4.13

Testing the roll over valve

The roll over valve vent has two functions. The first function is to vent the tank and the second function is to close off the vent if the tank is inverted.

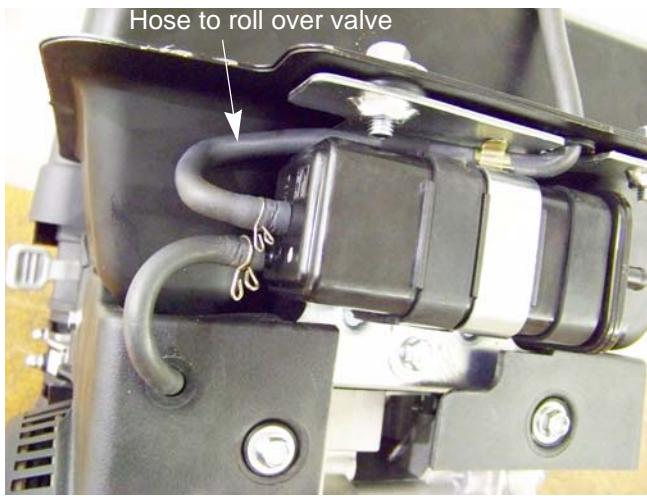

Figure 4.14

Test the roll over valve by:

1. Disconnect the hose that runs from the charcoal canister to the roll over valve. See Figure 4.14.
2. Connect a vacuum pump to the hose.
3. Slowly apply a vacuum to the roll over valve.

NOTE: If the roll over valve does not hold a vacuum, replace the canister.

4. If the roll over valve held a vacuum, disconnect the hose from the roll over valve.
5. Attach the vacuum pump directly to the roll over valve.
6. Slowly apply a vacuum to the roll over valve.

NOTE: If the roll over valve does not hold a vacuum, the hose has blocked. Replace the hose.

78/83/90 Series Horizontal Shaft Engines

Charcoal canister

To remove/replace the charcoal canister:

1. Disconnect the hoses from the canister. See Figure 4.15.

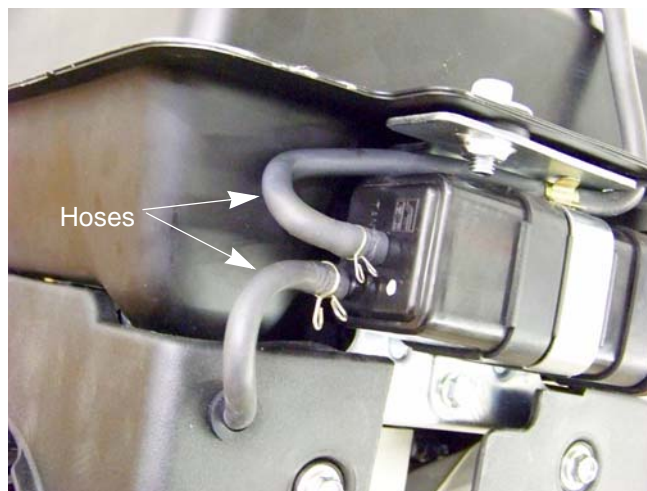

Figure 4.15

2. Remove the screw from the canister mounting strap using a 10 mm wrench. See Figure 4.16.

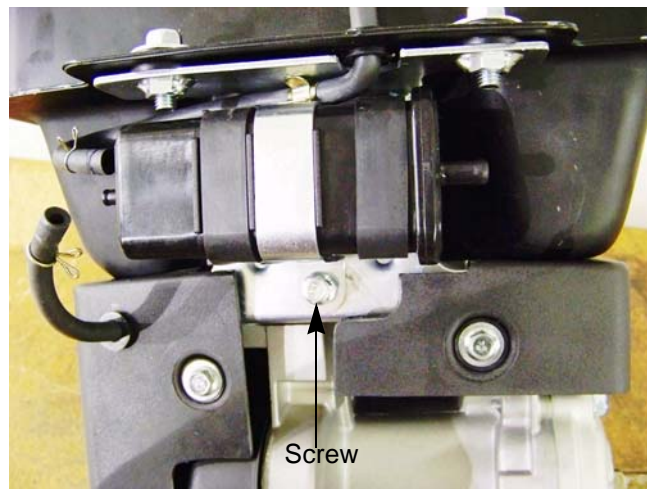

Figure 4.16

To Install the canister:

3. Insert the tab of the mounting strap into the slot in the fuel tank mounting bracket. See Figure 4.17.
4. Install the mounting screw.
5. Attach the hoses.
6. Test run the engine in a safe area before returning to service.

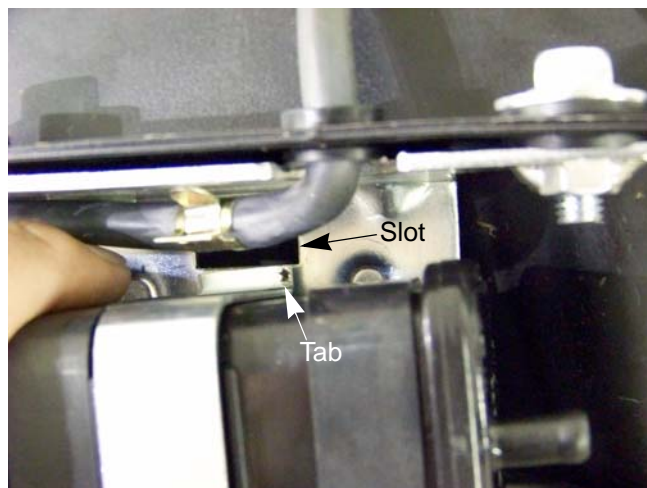

Figure 4.17

Roll over valve

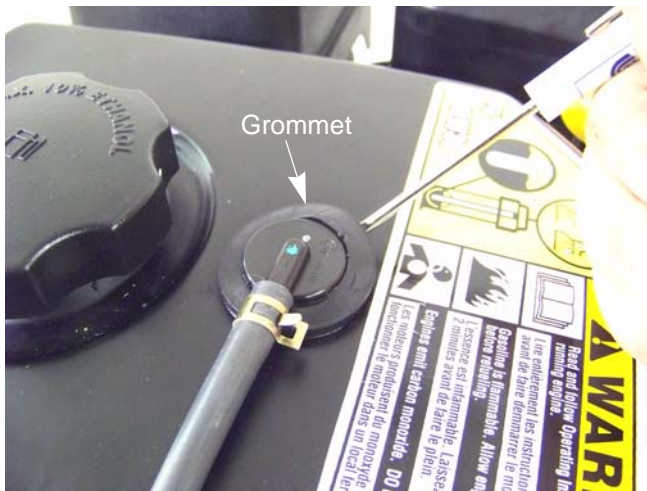

Figure 4.18

To remove the roll over valve:

1. Gently pry the grommet from in between the roll over valve and the fuel tank. See Figure 4.18.

NOTE: Leaving the hose connected to the roll over valve will help prevent it from falling inside the tank once the grommet is removed.

2. Lift the valve out of the fuel tank.
3. Disconnect the hose.



Figure 4.19

To install the roll over valve:

1. Inspect the rubber grommet, replace if damaged.
2. Slide the rubber grommet over the roll over valve.
3. Press the roll over valve assembly into the fuel tank opening.

NOTE: Soapy water can be used as a lubricant.

4. Install the hose from the canister.
5. Test run the engine in a safe area before returning to service.

78/83/90 Series Horizontal Shaft Engines

Choke

78/83/90 series MTD engines are equipped with a choke. The snow engines are also equipped with a primer, both of which must be used to start the engine.

NOTE: The choke should be opened after the engine starts. This can be a source of starting issues with customers who are not familiar with manual chokes.

NOTE: On the summer engines, the entire choke mechanism is part of the carburetor. See Figure 4.20.

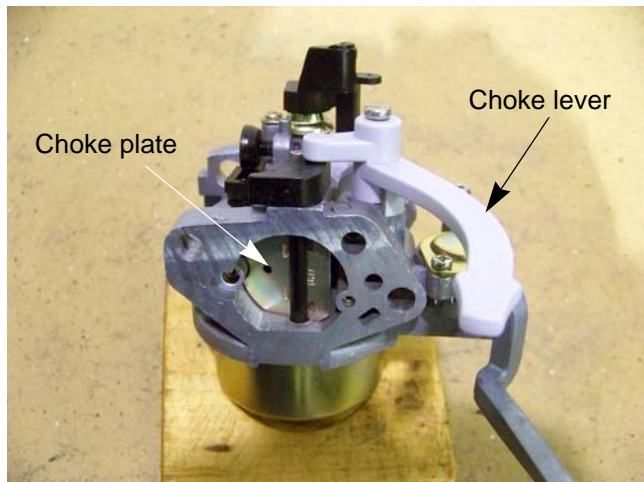

Figure 4.20

Choke mechanism (snow engines)

The choke is operated by a knob on the engine shroud. If the choke plate fails to close fully, the engine will be difficult or impossible to start when cold. See Figure 4.21.

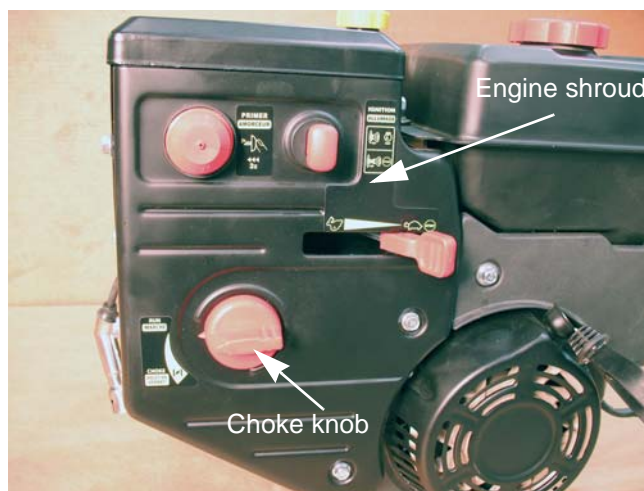

Figure 4.21

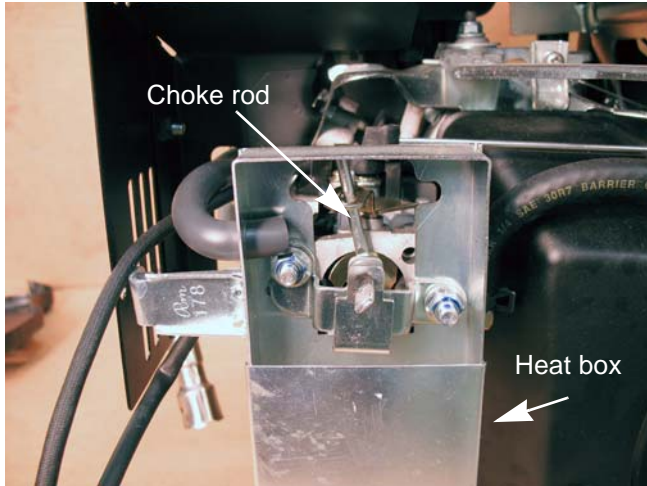

Figure 4.22

The choke rod is part of the heat box assembly mounted on the front of the carburetor. See Figure 4.22.

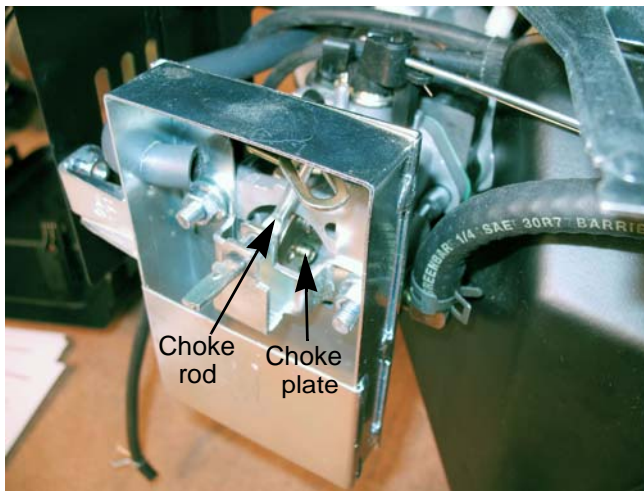

Figure 4.23

NOTE: The choke rod can be bent slightly to facilitate adjustment.

To adjust the choke rod:

1. Remove the choke knob and the engine shroud by following the steps described in Chapter 3: Air Intake Systems.
2. Rotate the choke knob shaft to verify full choke movement. See Figure 4.23.
3. If the choke plate does not open fully or close fully, adjust the choke linkage.

NOTE: When adjusting the choke linkage, make small bends and recheck the movement of the choke plate. Repeat this step until full movement is achieved.

4. Reassemble by following step 1 in reverse order.
5. Test run the engine before returning to service.

78/83/90 Series Horizontal Shaft Engines

Primers (snow engines)

MTD engines use a dry bulb primer. This means that there is no fuel in the primer bulb. The primer works by pushing air into the float chamber of the carburetor when the primer bulb is depressed. This will force fuel to be sprayed out of the main nozzle into the throat of the carburetor.

To test the primer:

1. Remove the engine shroud by following the steps described in Chapter 3: Air Intake Systems.
NOTE: Do not disconnect the primer hose.
2. Press the primer bulb while looking down the carburetor throat. If there is fuel squirting into the carburetor throat, the primer is working properly. If not, replace the primer and hose.
NOTE: The primer and primer hose come as an assembly so there is no need to determine which part is bad.

To replace the primer:

3. If the primer is bad, disconnect hose from the carburetor.
4. Remove the hose clamp at the rear of the primer bulb. See Figure 4.24.
5. The primer is held to the shroud by a pair of split, barbed posts. Squeeze the posts to release the barbs. See Figure 4.24.
NOTE: The primer bulb and hose will slide out as an assembly.
6. Install the new primer by following the above steps in reverse order.

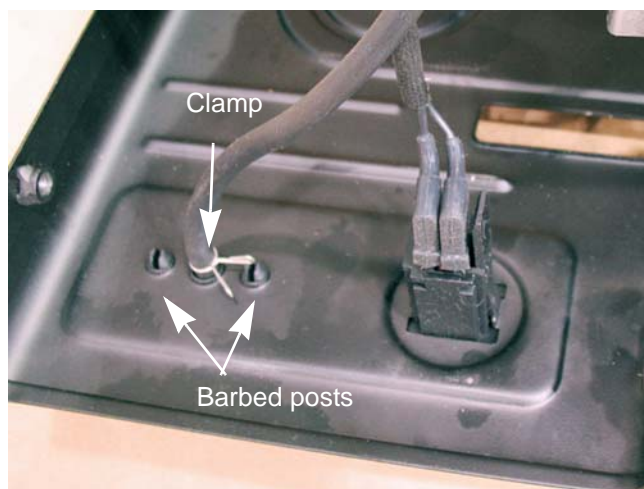

Figure 4.24

Carburetors

If diagnosis indicates a fuel problem, inspect the carburetor. This is important even if problems are identified elsewhere in the fuel system.

IMPORTANT: the fuel must be tested for alcohol content before diagnosing anything else on the engine.

NOTE: It is important to perform a compression or leak down test before condemning a carburetor. An engine can have a borderline compression reading and not create enough of a vacuum to draw in a sufficient fuel/air charge.

NOTE: To determine if border-line compression is the problem; remove the spark plug. Squirt a little bit of oil into the combustion chamber to seal the rings. Reinstall the spark plug. If the engine starts and runs ok, then that was the problem. If it does not start, move on to the carburetor.

Inspecting the carburetor

1. Remove the float bowl and check for dirt and/or varnish.
2. Inspect the needle valve and needle valve seat for dirt and/or damage.
3. Inspect the gaskets and O-rings for damage.
4. Inspect the vents and orifices, verify that they are free of debris.

NOTE: If a little cleaning and new gaskets will fix the carburetor, do it. If the carburetor requires extensive cleaning; it is better to replace the carburetor.

IMPORTANT: Never try to mechanically clean orifices. That will damage them and ruin the carburetor.

NOTE: The jet markings (if present) may be used for identification purposes, but the technician should not attempt to infer orifice sizes from the identification numbers.

NOTE: Installing the wrong main jet, or a carburetor with the wrong main jet will produce performance and emissions issues.

78/83/90 Series Horizontal Shaft Engines

Disassembly and rebuilding of the carburetor

1. Clamp-off the fuel line to prevent fuel spillage, then disconnect the fuel line from the carburetor.
2. Disconnect the primer hose.
3. Remove the carburetor by following the steps described in Chapter 3: Air Intake and Filter.

NOTE: An insulator separates the carburetor from the cylinder head.

- A bowl vent port is in a recessed passage on the end of the carburetor that faces the insulator.
- A second passage in the insulator supplements the passage on the carburetor.
- Gaskets separate the insulator from the cylinder head and the carburetor from the insulator.
- A port in the carburetor to insulator gasket ties the bowl vent passages together.

4. Check the vent passages. See Figure 4.25.
5. Check the gaskets and the insulator block.
6. Remove the bowl bolt using a 10mm wrench. See Figure 4.27.

NOTE: From this point an assessment can be made about the viability of rebuilding the carburetor.

- If extensive corrosion is evident, replace the carburetor.
- If varnish build-up is too extensive to clean, replace the carburetor.

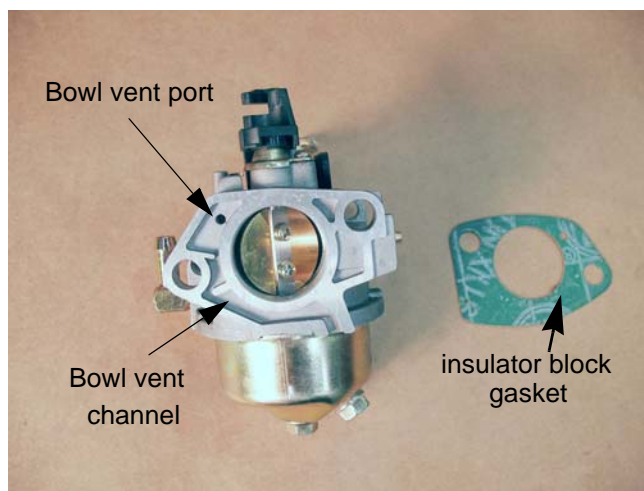

Figure 4.25

7. When inverted, the float should rest in a level position. See Figure 4.26.

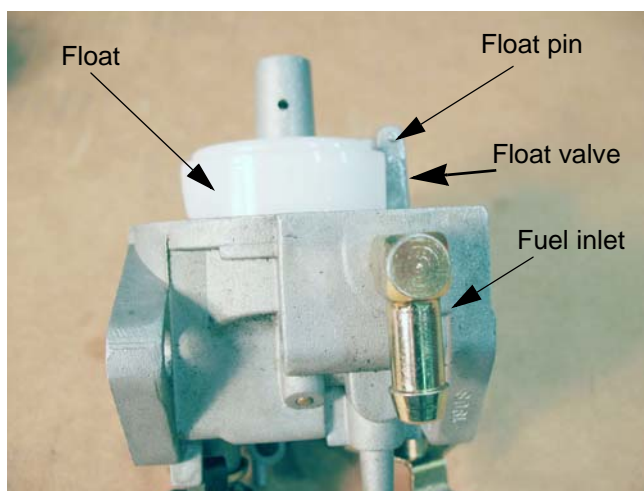

Figure 4.26

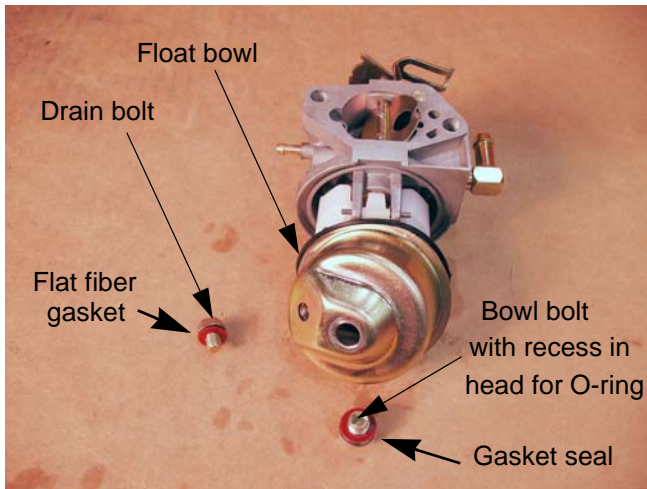

Figure 4.27

8. Remove the pin that the float hinges on to remove the float.

NOTE: The float is not adjustable. Spring tension against the float valve begins to build from the horizontal position, putting progressively more pressure between the tip of the valve and the seat. See Figure 4.28.

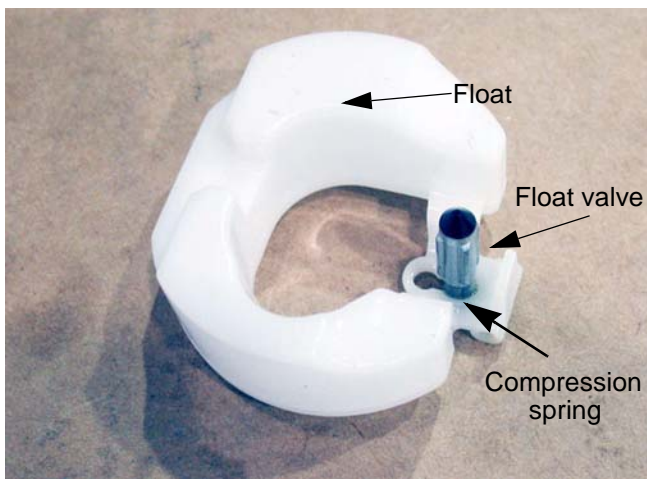

Figure 4.28

NOTE: Because the float valve is crucial to the functioning of the carburetor, and the viton tip of the valve is subject to wear, technicians should replace the valve and spring any time the carburetor is disassembled for cleaning.

- A square cross-section gasket seals the bowl to the body of the carburetor.

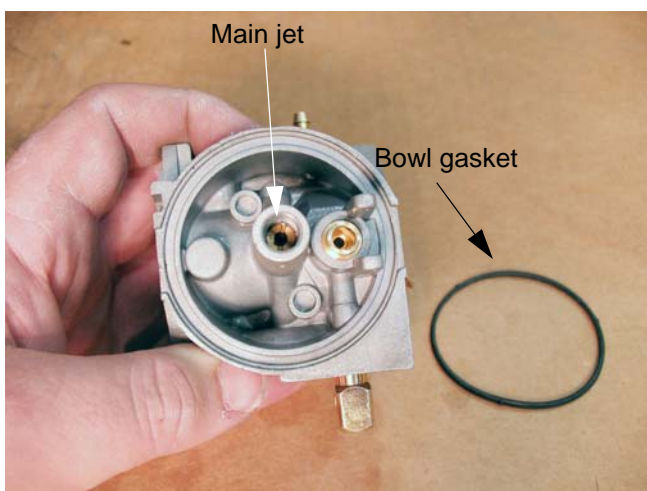

Figure 4.29

9. Remove the main jet using a narrow-shank straight blade screwdriver. See Figure 4.29.

NOTE: Fuel enters the central column through a port about 1/2" (1cm) from the bottom, to help prevent the ingress of any residue in the bottom of the bowl.

NOTE: The orifice in the main jet meters fuel into the central column.

NOTE: Air from the main jet emulsion port enters the central column near the top, then gets bubbled through the emulsion tube into the metered fuel flow to promote atomization.

78/83/90 Series Horizontal Shaft Engines

NOTE: The main jet secures the emulsion tube in the central column of the carburetor. See Figure 4.30.

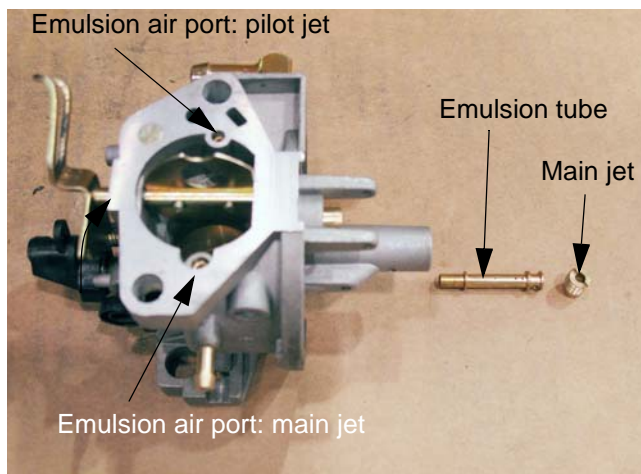

Figure 4.30

10. The throttle stop screw has a large pliable lip around the head of the screw. That lip secures a metering plug for the pilot and transition ports. Remove the screw to reach the plug. See Figure 4.31.

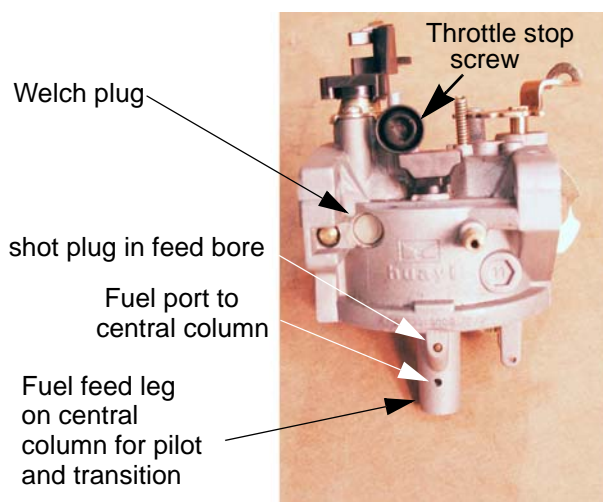

Figure 4.31

11. Carefully pry out the metering plug and spacer using a small screwdriver. See Figure 4.32.

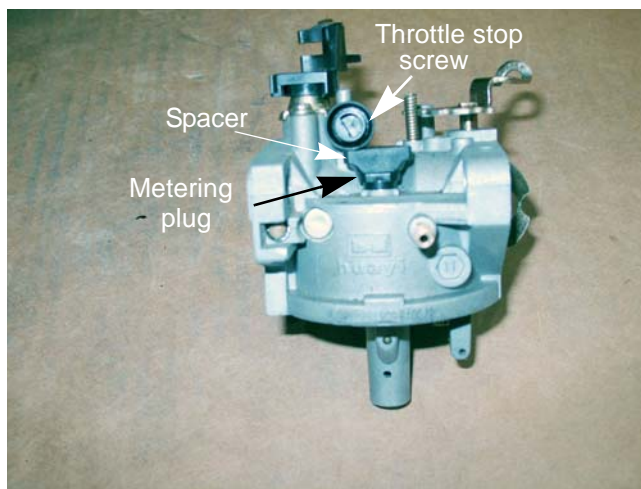

Figure 4.32

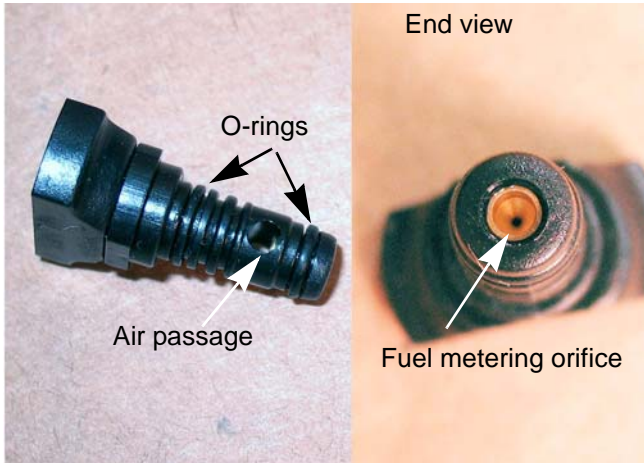

Figure 4.33

12. Examine the metering plug: See Figure 4.33.
 - Fuel, drawn from the central column via the long fuel feed leg, is metered by the brass orifice in the tip of the metering plug.
 - Air, drawn from the emulsion air port, is metered by the size of the brass orifice at the entrance to the port.
 - The fuel and air that feed the pilot and transition ports are mixed at the metering plug.
 - The metering plug creates a small venturi. The pressure drop of the air passing through the metering plug draws the fuel into the passage to the pilot and transition ports, in an emulsified mixture.

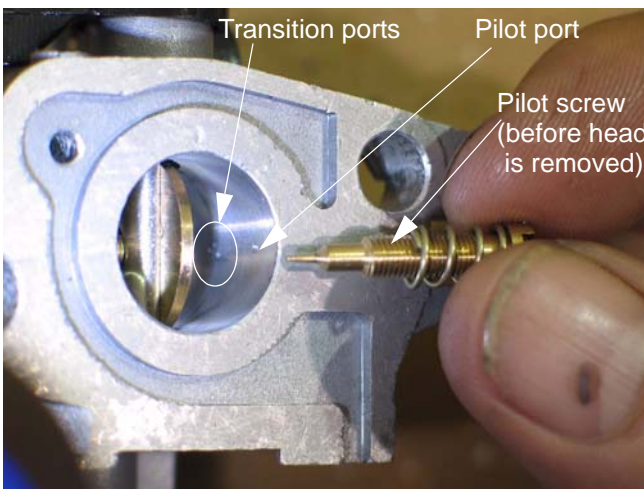

Figure 4.34

NOTE: The pilot screw regulates how much of this pre-mixed fuel/air emulsion is allowed to enter the throat of the carburetor, to atomize down-stream of the throttle plate. On current production units, it is set at the factory and the screw head is removed. See Figure 4.34.

NOTE: The transition ports are fixed. They are drilled into the throat of the carburetor, down-stream of the venturi. They lie behind the brass welch plug near the pilot screw.

13. Soak the Carburetor body in a suitable solvent until clean.

NOTE: Ultrasonic cleaning using a suitable water/detergent mixture will clean carburetors safely and effectively.



Figure 4.35

14. Rinse it thoroughly.
15. Dry the carburetor body using compressed air.
16. Reassemble the carburetor and install it by following steps 1-8 in reverse order.
17. Start the engine and check the idle RPM using a tachometer.
18. Check the top no load speed of the engine.

NOTE: The top no-load speed of the engine is 3500 RPM's \pm 100.

19. The top no-load speed is easily adjusted by tightening/loosing the speed adjustment screw. Tighten the screw to decrease speed and loosen it to increase speed. See Figure 4.35.

78/83/90 Series Horizontal Shaft Engines

Fuel shut-off valve

To prevent the needle valve from un-seating and flooding the engine while being towed, engines designed to go onto log splitters have a fuel shut-off valve built into the carburetor.

To service the shut-off valve:

1. Remove the carburetor by following the procedures described in Chapter 3: Air Intake Systems.
2. Remove the choke lever pivot screw. See Figure 4.36.
3. Lift the choke lever off of the carburetor.
4. Remove the shut-off valve cover using a #2 phillips screw driver. See Figure 4.36.

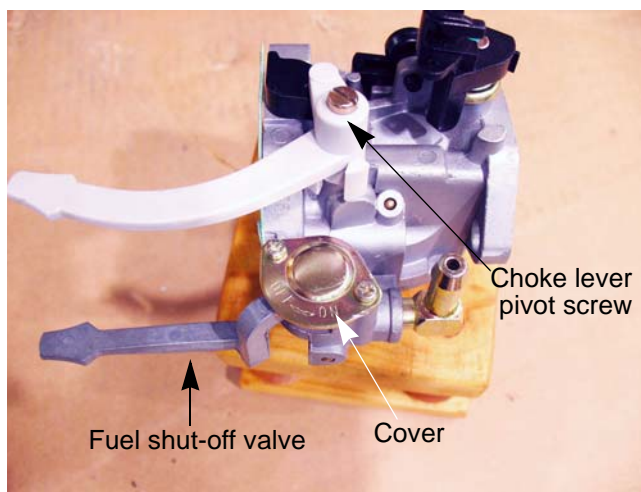

Figure 4.36

5. Remove the wave washer. See Figure 4.37.

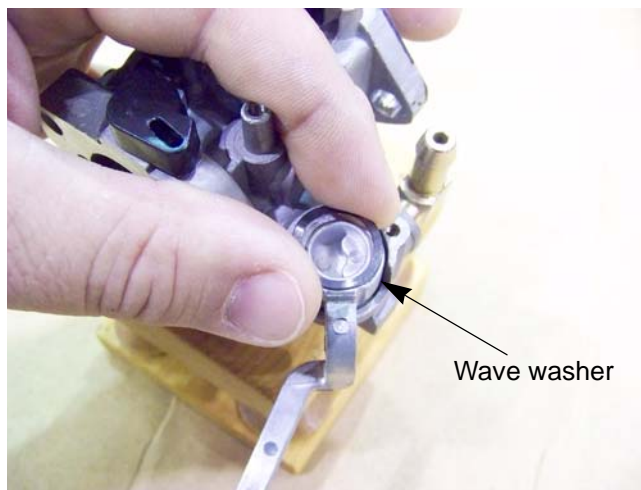

Figure 4.37

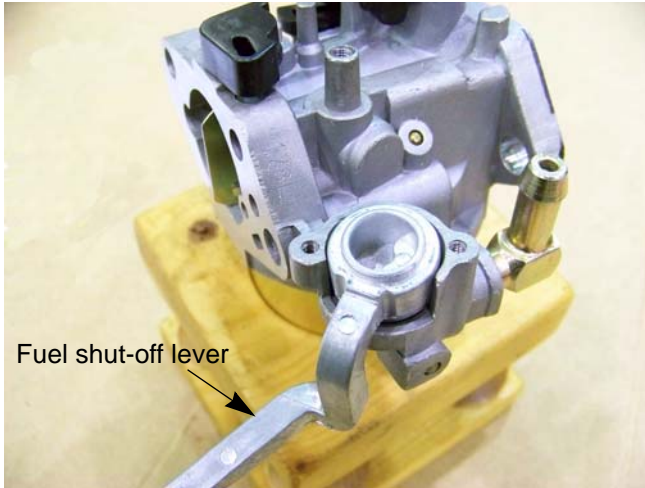

Figure 4.38

6. Remove the fuel shut-off lever. See Figure 4.38.

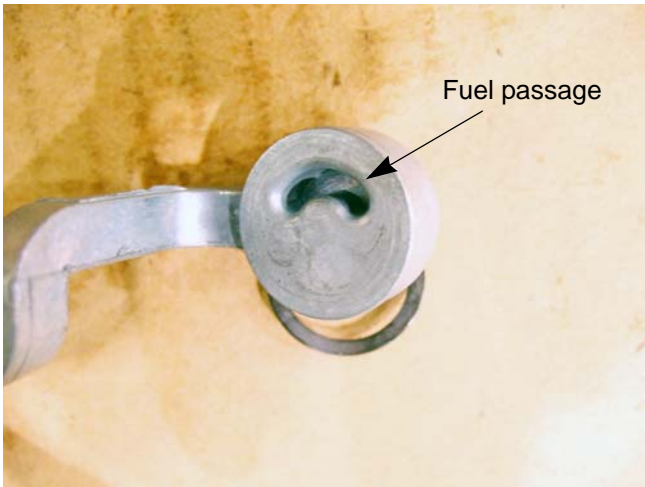

Figure 4.39

NOTE: There is a passage cast into the shut-off lever. When this passage lines up with the two posts in the carburetor, fuel will flow to the needle valve.

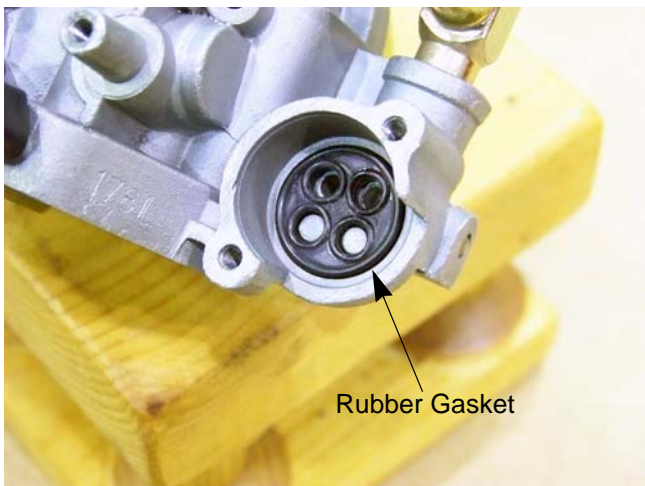

Figure 4.40

7. Remove the rubber gasket. See Figure 4.40.
8. Re-assemble the fuel shut-off valve by following the previous steps in reverse order.
9. Test run the engine before returning it to service.

78/83/90 Series Horizontal Shaft Engines

Governor

The engine speed is controlled by a balance between the force applied by a spring (pulling the throttle open) and a flyweight mechanism within the engine applying force to the governor arm (pushing the throttle closed). See Figure 4.41.

NOTE: While the mechanism is simple and robust, it is important to pay attention when working on parts near the governor. Binding caused by interference with mis-routed lines or cables may make the governor unresponsive.

NOTE: When a governed engine “hunts”, it is generally an indication of a lean fuel/air mixture, rather than a problem with the governor.

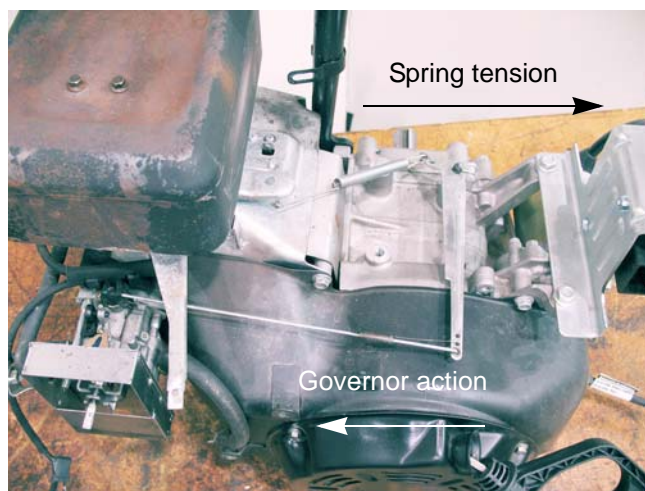

Figure 4.41

Governor arm

To remove the governor arm from the governor shaft:

1. Remove the fuel tank by following the steps described in the Fuel Tank section of this chapter.

NOTE: Mark or note which holes the spring and linkage was in to ensure they go back in the same holes.

2. Unhook the governor spring.
3. Loosen the nut and clamp bolt. See Figure 4.42.
4. Carefully spread open the seam on the arm.
5. Carefully slide the Governor arm off of the governor shaft.
6. Unhook the governor linkage and throttle return spring.

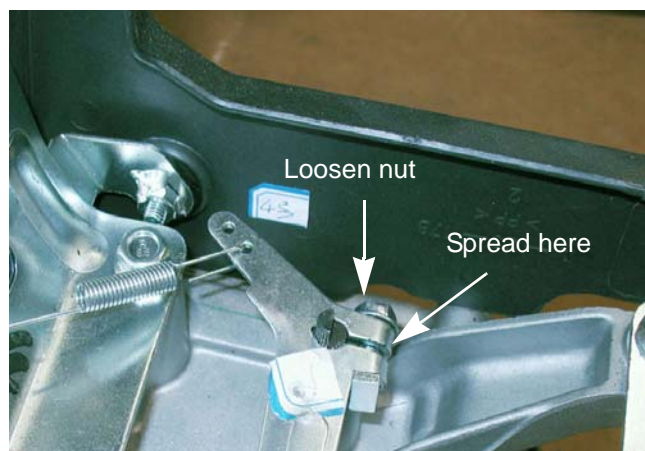

Figure 4.42

To install the governor arm:

1. Rotate the governor shaft clockwise until it stops.
2. Slide the arm onto the shaft. The flat on the top of the shaft should be roughly parallel to the arm. See Figure 4.42.

NOTE: There is a hairpin clip that keeps the governor shaft from sliding into the engine. It may be necessary to hold the shaft while sliding the arm on to prevent the hairpin clip from “popping off” and allowing the governor shaft to fall into the engine.

3. Tighten the nut on the clamp bolt to secure the arm.
4. Attach the governor linkage and spring.
5. Adjust the governor to maintain top no-load speed as described in a previous section of this chapter.

Governor shaft

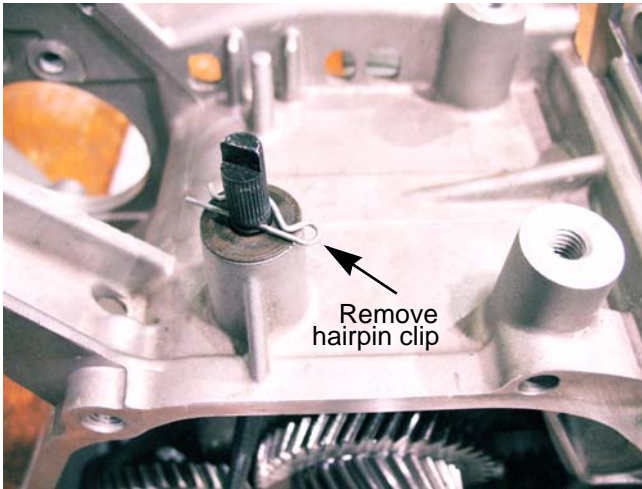

Figure 4.43

To remove or replace the governor shaft:

1. Remove the engine from the equipment that it powers.
2. Remove the governor arm by following the previously described steps.
3. Remove the flywheel by following the steps described in Chapter 7: Ignition Systems.
4. Remove the crank case cover and crankshaft from the engine by following the steps described in Chapter 10: Cam, Crankshaft and Piston.
5. Remove the hairpin clip from the governor shaft. See Figure 4.43.
6. Slide the governor arm out of the engine block from the inside of the engine.
7. Check the movement of the fly-weights and cap on the governor gear.
8. Install the shaft by following the above steps in reverse order.
9. Install the engine on the equipment it powers.
10. Test run the engine and adjust the top no load engine rpms by following the steps described in the carburetor section of this chapter.

78/83/90 Series Horizontal Shaft Engines

Governor cup and the governor gear

The Governor gear and cup are located inside the crankcase cover. The flyweights and the governor cup are inter locked on this family of engines. The governor gear and cup are serviced as a complete assembly.

1. Remove the engine from the equipment that it powers.
2. Remove the crank case cover from the engine by following the steps described in Chapter 10: Cam, Crankshaft and Piston.
3. Position the crank case cover over an open vise so that the governor gear can pass through its jaws.
4. Drive out the governor pin using a pin punch. See Figure 4.44.

NOTE: There is a washer between the governor cup and the crank case cover. this washer will fall out when the governor comes out.

5. Install the governor gear and cup assembly by placing the washer on the inside of the crank case cover. See Figure 4.45.
6. Apply a small amount of releasable thread locking compound such as Loctite® 242 (blue) to the governor pin.

7. Position the governor gear and cup assembly with the pin in the hole in the crank case cover.
8. By gently striking the governor cup, drive the governor pin into the crank case cover until it is flush with the out side of the cover.
9. Install the crank case cover by following the procedures described in Chapter 10: Cam, Crankshaft and Piston.
10. Install the engine onto the equipment it came off of.
11. Test run the engine in a safe area before returning it to service.

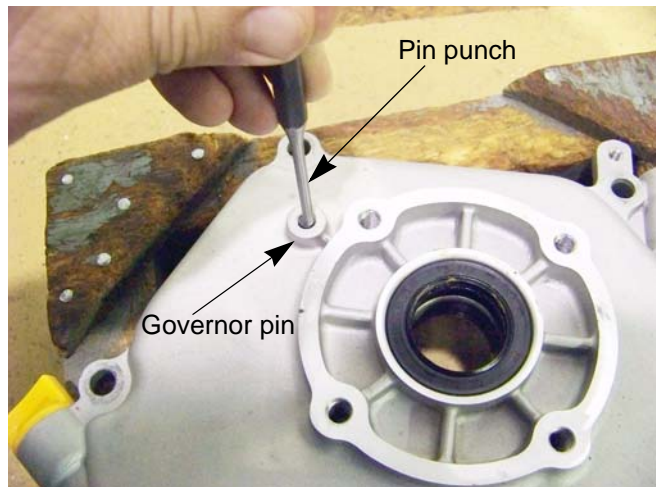

Figure 4.44



Figure 4.45

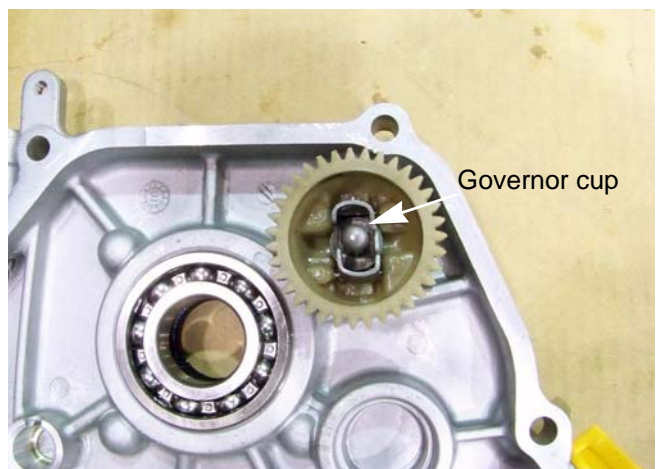

Figure 4.46

Governor adjustment

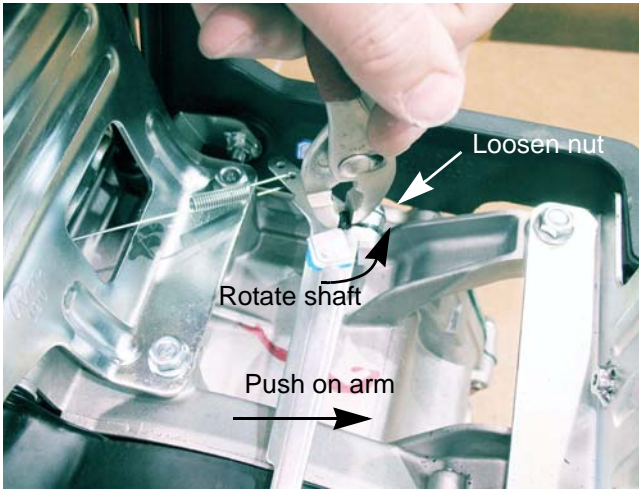

Figure 4.47

To adjust the governor:

1. Remove the fuel tank by following the procedures described in the fuel tank section of this chapter.
2. Loosen the governor arm nut but do not remove the nut completely.
3. Pry open the governor arm crimp with a flat head screwdriver. See Figure 4.47.
4. Using pliers, grab the flat section at the top of the governor shaft and rotate it in a counter clockwise direction as far as it can go.
5. Push the governor arm to the right (the spring should pull it in this direction).

NOTE: Rotating the shaft counter clockwise will ensure the governor cup is pressed all the way down on the governor gear flyweights. Pushing on the governor arm to the right ensures the throttle is wide open against the throttle stop.

6. Re-tighten the governor arm nut to crimp the governor arm onto the governor shaft.
7. Install the fuel tank.
8. Test run the engine in a safe area. Set the engine RPM's to 3500 ± 100 .

For Parts Call 606-678-9623 or 606-561-4983

78/83/90 Series Horizontal Shaft Engines

CHAPTER 5: LUBRICATION

Oil type and quantity

MTD engines use oil with a SF/SG API rating or better is the recommended oil for this engine.

- The winter engines use SAE 5W-30 oil.
- The summer engines use SAE 10W-30 oil.
- The oil capacity for all of the 78/83/90 series engines is 37 fl.oz (1.1 liters).

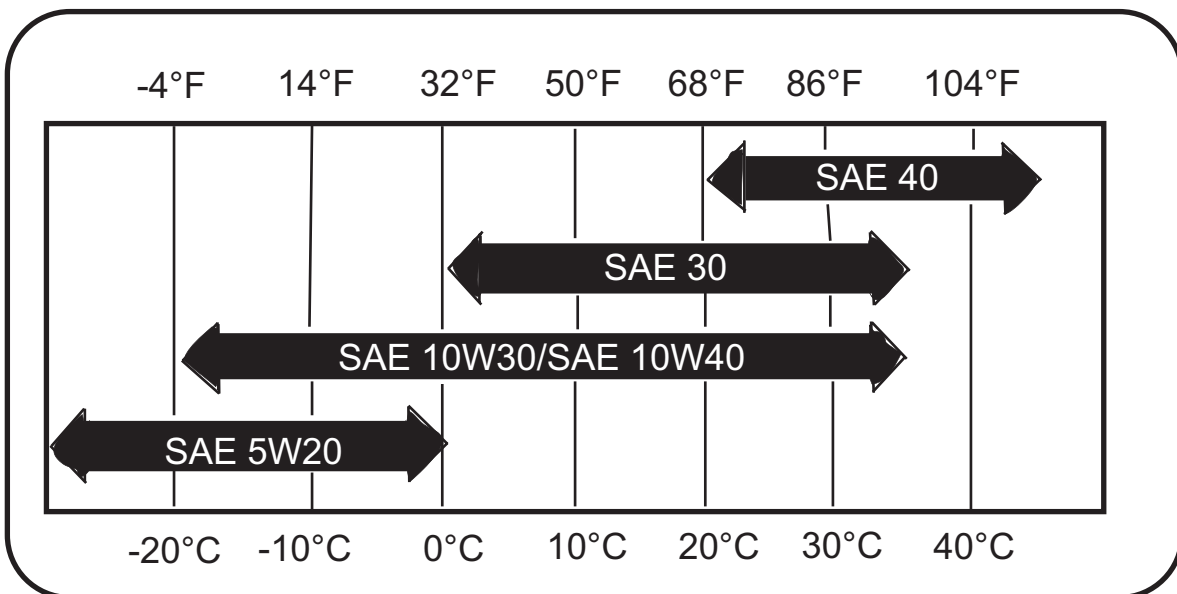

Oil Chart

- If the oil is noticeably thin, or smells of gasoline, a carburetor repair may be needed before the engine can be run safely.
- Check the oil level frequently and change the oil more frequently in severe operating conditions such as exceptionally deep snow falls.
- Synthetic oil is a suitable alternative, but it does not extend service intervals.

NOTE: MTD recommends the use of petroleum oil during the break in period to ensure the piston rings correctly break in.

Synthetic vs. Petroleum based oil: To simply look at synthetic oil and to compare it with Petroleum based oil there is very little difference. However, when you look at the two through a microscope it is easy to see the difference. Synthetic is made up of smaller molecules. This allows the oil to get into areas that petroleum based oil cannot.

78/83/90 Series Horizontal Shaft Engines

Oil dip stick

NOTE: There are two types of dip sticks that can be found on MTD engines; a threaded dip stick that was used on older engines and a quarter turn dip stick that is used on engines currently being produced. See Figure 5.1.

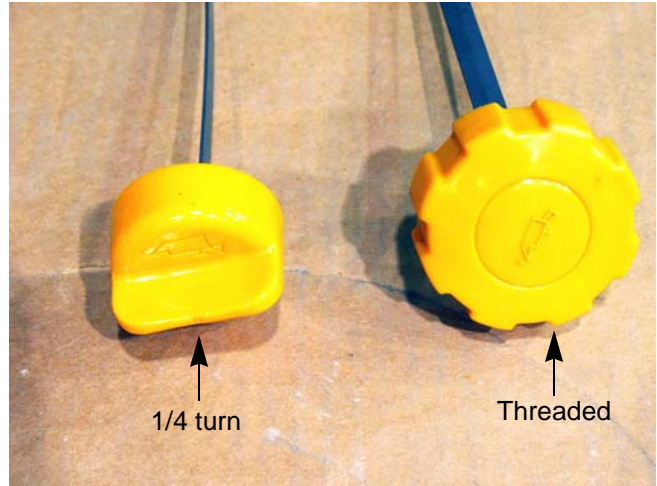

Figure 5.1

To check the oil with a threaded dip stick:

1. Twist and remove the dip stick from the engine.
2. Clean the oil off of the tip of the dipstick.
3. Re-insert the dipstick **without** threading it in to get the oil level reading. See Figure 5.2.
4. The oil level is determined by the lowest point on the dipstick that is completely covered with oil.



Figure 5.2

To check the oil with a 1/4 turn dip stick:

1. Twist and remove the dip stick from the engine.
2. Clean the oil off of the tip of the dipstick.
3. Re-insert the dipstick **and turn it until it is fully seated** to get the oil level reading. See Figure 5.3.
4. The oil level is determined by the lowest point on the dipstick that is completely covered with oil.



Figure 5.3

Dip stick tube removal

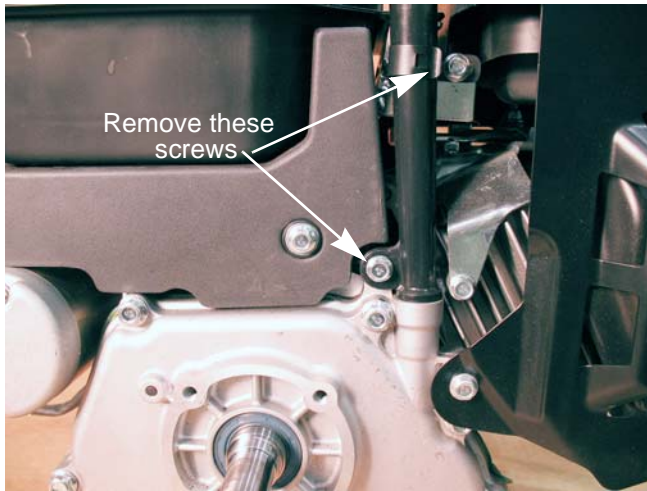

Figure 5.4

To remove/replace the dip stick tube:

NOTE: The procedure to remove the dip stick tube is the same for both styles of dip stick.

NOTE: A threaded dip stick and tube assembly is interchangeable with a quarter turn dip stick and tube assembly.

1. Remove the upper screw that secures the dip stick tube to the fuel tank support bracket using a 10 mm wrench. See Figure 5.4.
2. Remove the screw at the bottom of the dip stick tube using a 10 mm wrench. See Figure 5.4.
3. Pull the dip stick tube out of the engine block.
4. Inspect the O-rings on the dip stick and the dip stick tube. Replace if damaged.

NOTE: Lubricate the O-ring for installation.

5. Install by following the above steps in reverse order.

78/83/90 Series Horizontal Shaft Engines

Lubrication system

MTD uses a splash lube system for its horizontal shaft engines. The connecting rod has a dipper on it that “splashes” oil around the inside of the engine. See Figure 5.5.

NOTE: The cam and the balance shaft were removed for a better view of the lubrication system.

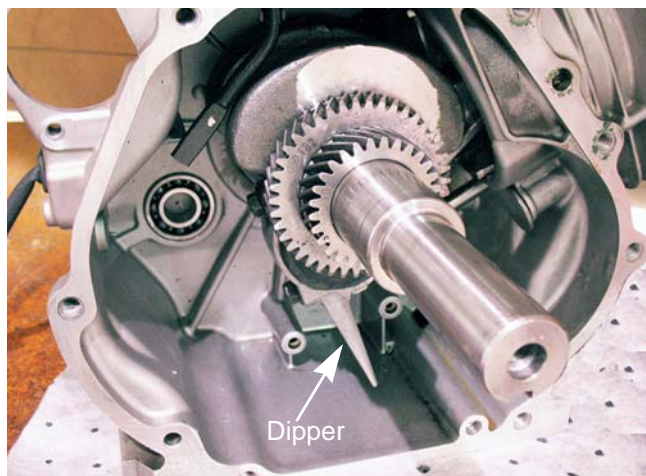

Figure 5.5

The splashing action will create an oil mist that reaches the cylinder head. There are two oil passages that run along the engine cylinder. The one on the top side of the engine is the oil supply passage. The oil mist will flow through this passage to the cylinder head. See Figure 5.6.

The second oil passage runs along the bottom side of the cylinder. This is the oil return passage. As the name implies, it allows the oil collecting in the cylinder head to return to the sump. The return passage is the tiny hole that is in between the two tappet passages.

NOTE: Because these engines use splash lubrication, the type of oil and the oil level is critical for proper operation of the engine. If the oil level is too low, the dipper on the connecting rod cannot splash the oil into the engine. If the oil level is too high, the oil will not change into a mist to reach the upper side of the engine.

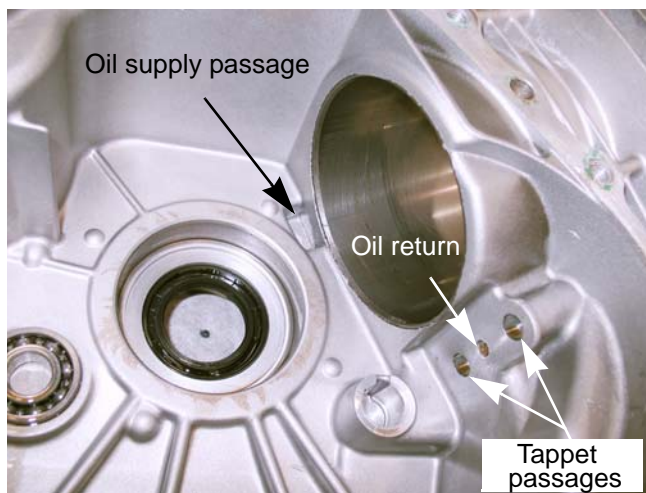

Figure 5.6

Positive crankcase ventilation valve

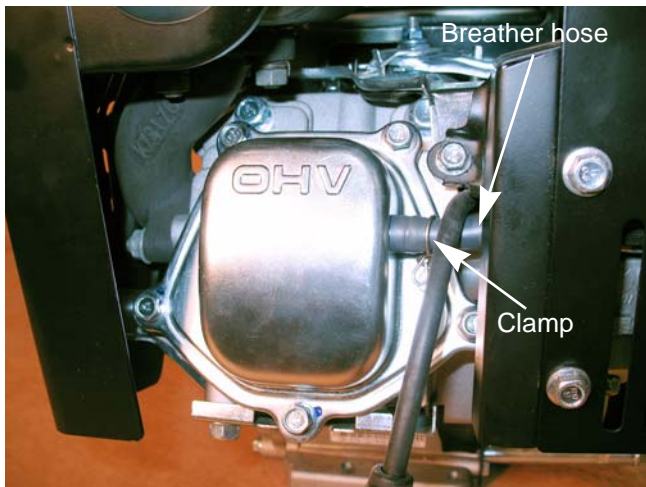

Figure 5.7

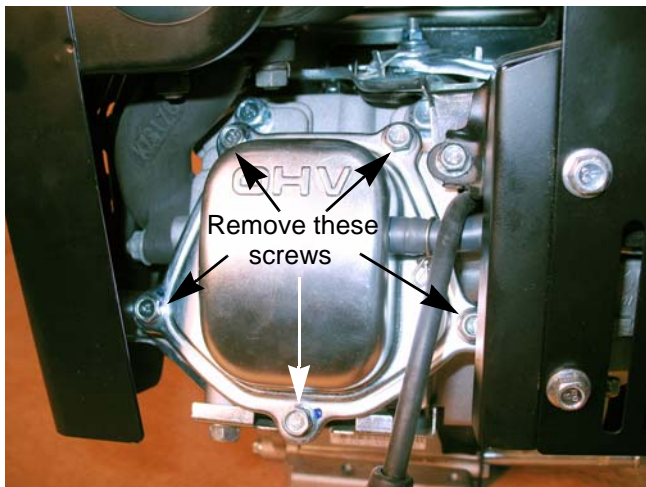

Figure 5.8

To remove the valve cover and PCV valve:

NOTE: The PCV valve is located inside the valve cover. The function and test procedures for the PCV valve is covered in Chapter 2: Basic Troubleshooting.

1. Disconnect and ground the spark plug wire.
2. Squeeze the spring clamp that secures the breather hose to the valve cover nipple and slide it back. Then remove the breather hose from the valve cover nipple. See Figure 5.7.

3. Remove the five screws that hold the valve cover to the cylinder head using a 10mm wrench. See Figure 5.8.

NOTE: The PCV valve is not serviceable. If it is faulty, the valve cover must be replaced.

4. Reassemble the PCV and valve cover by following the above steps in reverse order.

NOTE: Tighten the cover bolts to a torque of 62 - 79.7 in-lbs. (7-9 Nm).

5. Inspect the PCV tubing for cracks, brittleness or signs of leaking. Replace the PCV tube if any are found.

6. Test run the engine before returning to service.

For Parts Call 606-678-9623 or 606-561-4983

78/83/90 Series Horizontal Shaft Engines

CHAPTER 6: STARTER AND CHARGING SYSTEMS

There are two starter systems available for the MTD engine. The first one is a recoil starter and the second is a 110 volt electric starter. All of the 78/83/90 series MTD engines equipped with an electric starter, are also equipped with a recoil starter.

Recoil Starter Removal

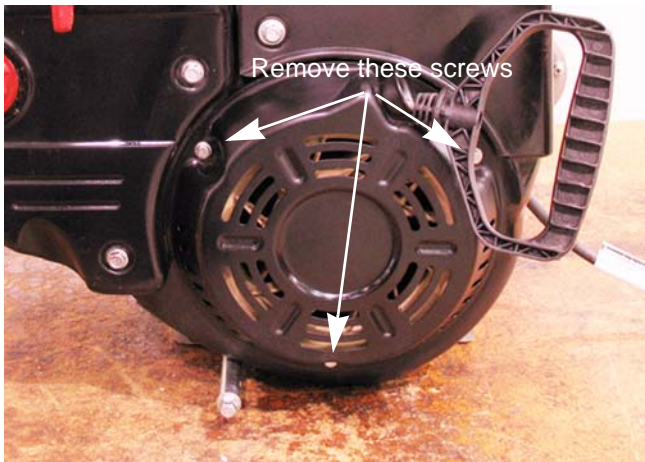

Figure 6.1

To remove recoil assembly from the engine:

1. Remove the three nuts that secure the recoil assembly to the engine using a 8mm wrench. See Figure 6.1.
2. Install the starter by following the above step in reverse order. Tighten the screws to a torque of 53 - 71 in-lbs (6-8 Nm).

78/83/90 Series Horizontal Shaft Engines

Starter Cup

The starter cup is a steel cup that is bolted to the flywheel.

1. Inspect the inside of the starter cup. See Figure 6.2.

NOTE: If the starter was failing to engage the flywheel, and the edges of the slots inside the cup are burred or damaged, replace the starter cup.

NOTE: If the starter cup is replaced, the complete starter should be replaced as well, to prevent a repeat failure.

2. Block the piston to prevent the crank shaft from turning by:
 - 2a. Remove the spark plug.
 - 2b. Insert approximately 3.5 feet of starter rope in the spark plug hole.

NOTE: Leave part of the rope sticking out of the engine so that the rope can be removed later.

3. Remove the starter cup by removing the flywheel nut.
4. Install a starter cup:
 - Place the starter cup on the flywheel, with the three bosses on the bottom of the starter cup into the dimples in the flywheel
 - Align the pin on the flywheel fan with the hole in the starter cup. See Figure 6.3.
5. Install the flywheel nut and tighten it to a torque of 47 - 52 ft-lbs (64 - 70 Nm).

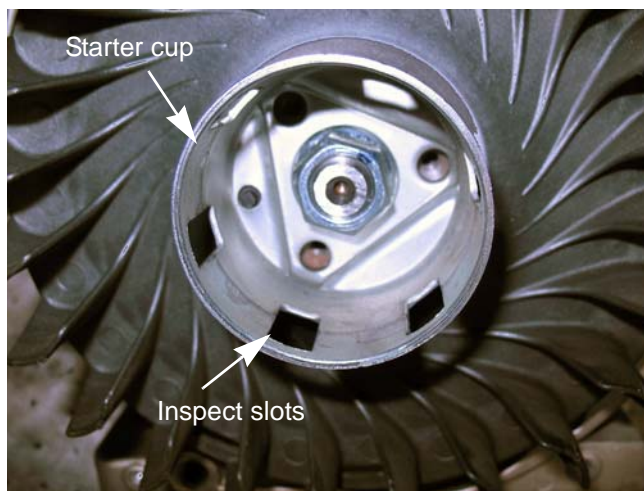

Figure 6.2

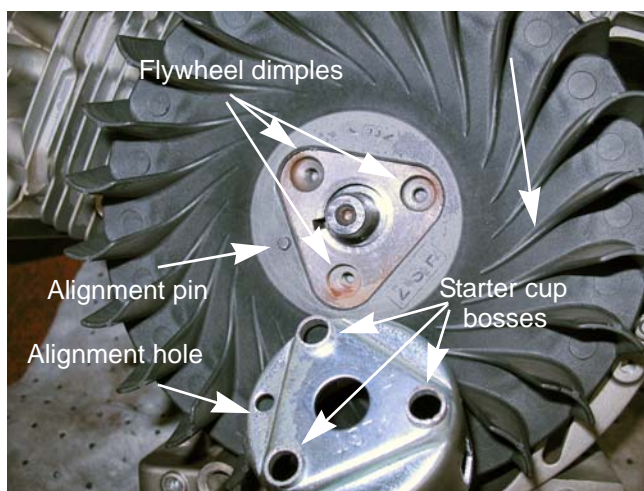

Figure 6.3

Starter and Charging System

Starter Rope

The most common failure mode for most recoil assemblies is a broken rope.

NOTE: If the spring was not damaged when the recoil sprung back, it is possible to simply remove the remnants of the old rope and install a new rope.

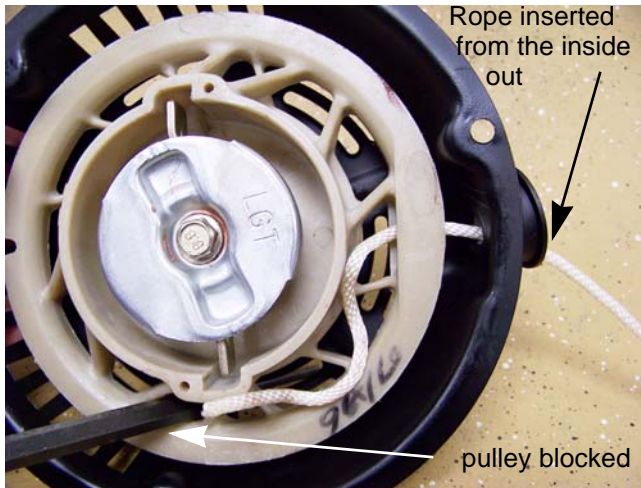

Figure 6.4

1. Remove the starter by following the steps described earlier in this chapter.
2. Remove the old starter rope by prying out the starter cord knot and pulling the rope out with it.
3. Cut a piece of #6 recoil rope 75" (1.9 meters) long.
4. Heat fuse the ends of the starter rope, and tie a double half-hitch in one end.
5. The rope may be easily installed from the outside-in. Pull the rope tight to seat the knot firmly in the recess in the back of the pulley. See Figure 6.4.

NOTE: It may be necessary to wind the pulley clockwise to line up the hole in the pulley to the hole in the starter housing. If so, use a punch or screwdriver to block the pulley, preventing it from rewinding. See Figure 6.4.



Figure 6.5

6. Wind the spring 6 - 7 turns and block it with a punch or screwdriver to keep it from rewinding.
7. Install the handle and handle insert on the loose end of the rope, again using a double half-hitch. See Figure 6.5.
8. Remove the blocking tool and let the rope rewind into the starter at a controlled rate.

78/83/90 Series Horizontal Shaft Engines

9. Give the starter a couple of test pulls to verify the right amount of tension on the starter rope and check the action of the pawls.

NOTE: If starter rope tension needs to be adjusted, hook the rope into the notch in the pulley and wind the pulley a couple of turns to add tension-. See Figure 6.6.

10. Install the starter and tighten the starter nuts to a torque of 53 - 71 in-lbs (6-8 Nm).



Figure 6.6

Starter and Charging System

Starter pulley and recoil spring

If damage is suspected, the recoil may be disassembled by:

NOTE: The recoil spring is nested within the starter pulley and both parts are sold as a single part number.



Eye protection should be worn if the starter pulley is to be removed.

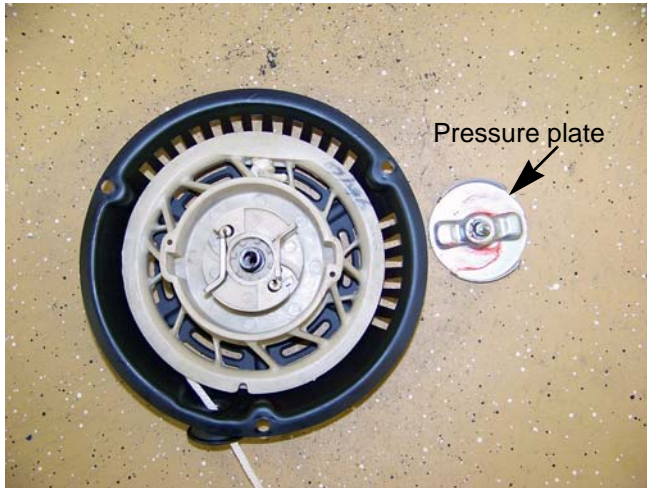

Figure 6.7

1. Remove the starter by following the steps described earlier in this chapter.
2. Relieve the spring tension by:
 - 2a. Pull some slack in the rope inside of the starter
 - 2b. Hook the rope into the notch in the starter pulley.
 - 2c. Wind the pulley clockwise until all tension is removed.
3. Remove the shoulder screw and pressure plate using a 10 mm wrench. See Figure 6.7.

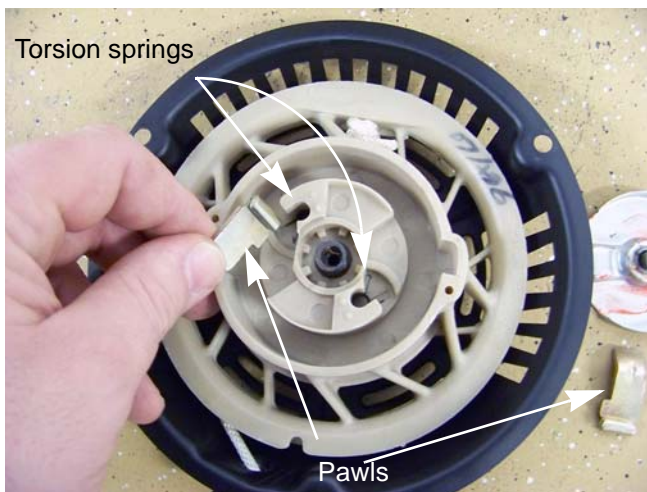

Figure 6.8

- NOTE:** Beneath the pressure plate is a compression spring and two starter pawls that are held in the disengaged position by two torsion springs.
4. Inspect the pawls and torsion springs for wear and damage. See Figure 6.8.

78/83/90 Series Horizontal Shaft Engines

- Carefully lift the spring and pulley out of the recoil housing. See Figure 6.9.



The recoil spring is under tension and can release as the pulley is removed.

Eye protection should be worn while removing the starter pulley.

NOTE: If the spring is undamaged, but has been removed from the pulley, the spring may be re-wound. Hook the end of the spring into the slot in the outer lip of the recess of the pulley and wind the spring into the recess in a counter-clockwise direction.

NOTE: Evaluate the damage, including parts prices and local labor rates. In some parts of the country, it makes economic sense to replace the complete assembly, in other areas labor rates favor repair.

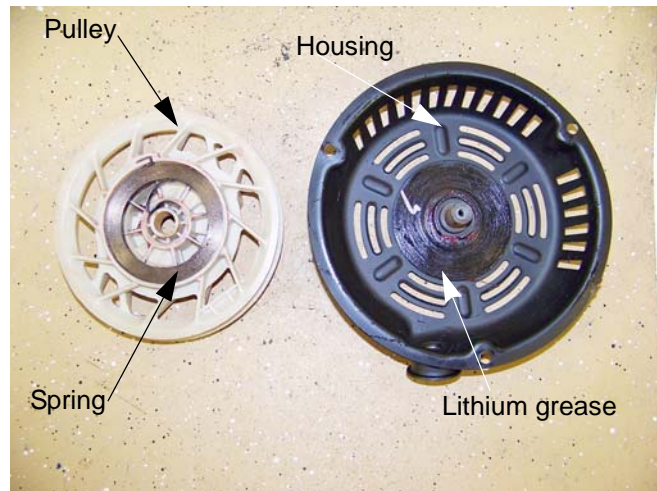

Figure 6.9

- To re-assemble, apply a small amount of lithium-based chassis grease to the surface of the recoil housing that contacts the spring.
- NOTE:** Use low temperature grease on the snow engines.
- Carefully position the pulley and spring in the recoil housing. Rotate the pulley gently counter-clockwise until the spring seats, allowing the pulley to fall into position.
- Install the torsion springs and pawls so that the long arm of the spring reaches outside of the pawl, and draws it toward the center of the assembly. See Figure 6.10.

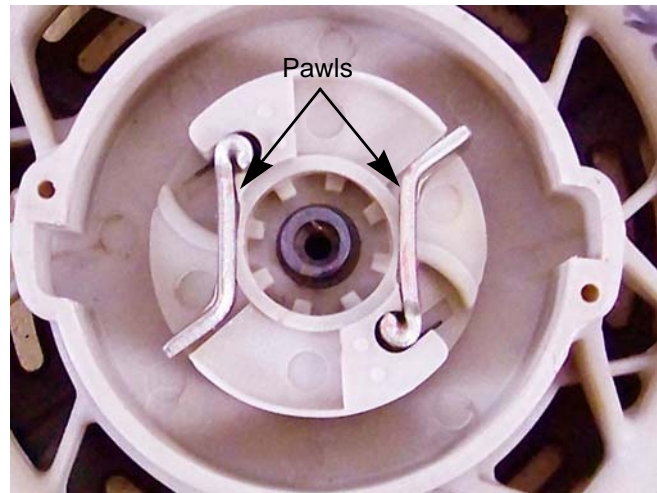

Figure 6.10

NOTE: The rolled end of the pawl fits in the recess in the starter pulley. The bent end engages the starter cup. The roll faces inward and the hook faces outward.

NOTE: The extrusions on the pressure plate should fall inside of the pawls as the starter is assembled.

NOTE: Drag on the pressure plate, from the friction between the compression spring and the head of the shoulder screw causes these extrusions to force the pawls outward, engaging the starter cup.

- Apply a small amount of thread locking compound such as Loctite 242 (blue) to the threads of the shoulder screw, and install the screw. Tighten it to a torque of 71 - 89 in-lb. (8 - 10 Nm).
- Install the starter rope by following the steps described in the previous section of this chapter.
- Install the starter and tighten the starter nuts to a torque of 53 - 71 in-lbs (6-8 Nm).

Starter and Charging System

Electric starter

The electric starter is only available on the snow engine. It is powered by an extension cord that is plugged into household 120 volt AC current. The starter and switch assembly are one piece and are not serviceable.

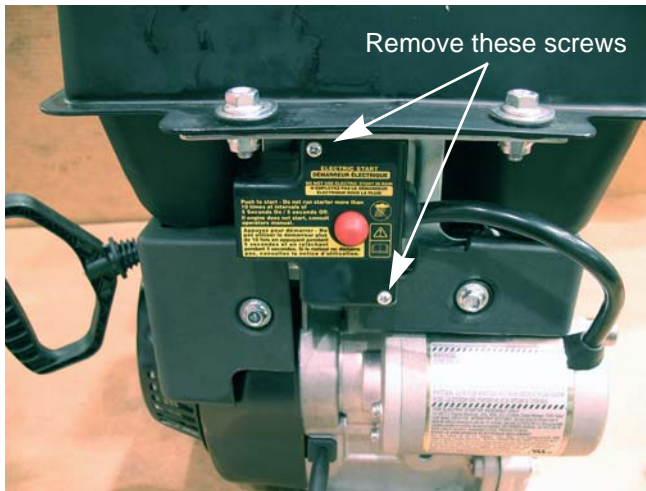

Figure 6.11

To replace the starter assembly:

1. Disconnect the extension cord.
2. Remove the two screws that secures the switch box to the engine. See Figure 6.11.

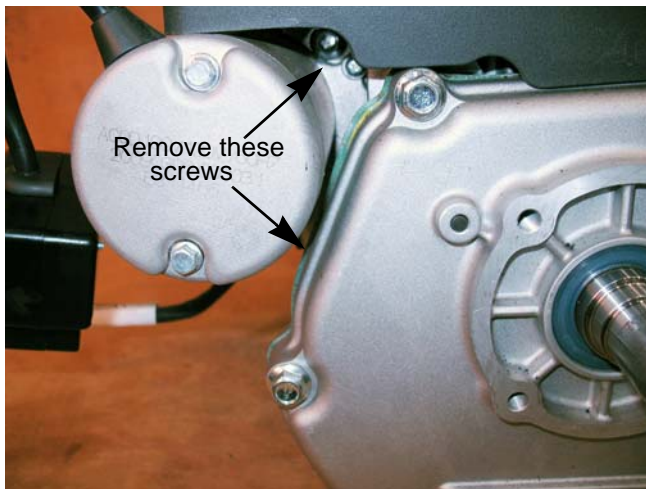

Figure 6.12

3. Remove the starter by removing the two screws that hold it to the engine block using a 10mm socket and a long extension. See Figure 6.12.

78/83/90 Series Horizontal Shaft Engines

4. Pull back on the starter approximately 1/2". Then angle it away from the engine while sliding it out of the engine. See Figure 6.13.

NOTE: Before condemning a starter make sure to bench test it. To bench test a starter:

- A. Remove the starter from the engine.
 - B. Plug the extension cord into the switch housing.
 - C. Hold the starter down and press the starter button.
- If the starter works on the bench, confirm that the engine crankshaft rotates with normal force.
 - If the crankshaft does not rotate with normal force, identify and repair the engine problem.

NOTE: This includes adjusting the valve lash.

- If the crankshaft rotates with normal force but the starter is unable to turn it, replace the starter.
 - If the starter does not work, replace the starter.
4. Install the starter by following the above steps in reverse order.

NOTE: Tighten the starter screws to a torque of 195 - 221 in-lbs (22-25 Nm).



Figure 6.13

Starter and Charging System

Charging system

Some engines are equipped with a charging system. The charging system used on MTD engines consists of three components, the rotor, stator and the rectifier.

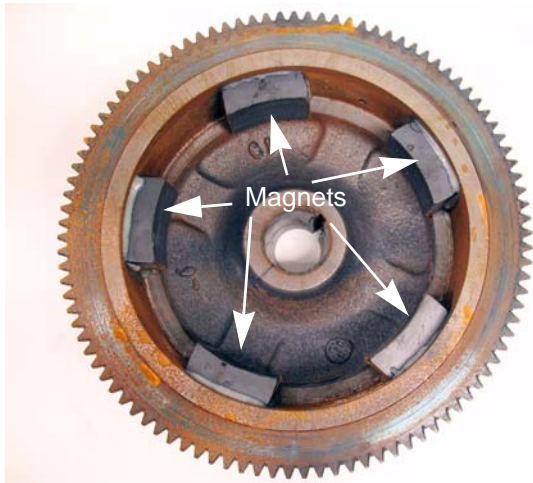

Figure 6.14

- Alternator rotor: The rotor consists of five magnets on the inside of the flywheel that rotate around a stator that is mounted to the cylinder block. As the crankshaft and flywheel rotate, the moving magnets induce a charge in the stator. See Figure 6.14.

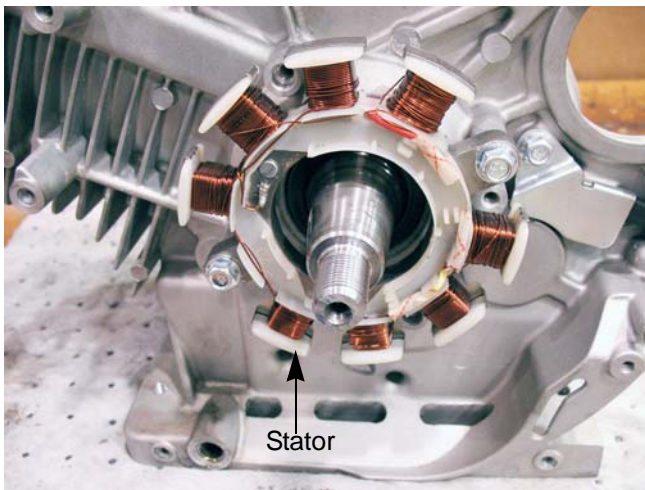

Figure 6.15

- Alternator stator: The stator consists of copper field windings around an iron core. The stator is attached to the engine block beneath the flywheel. See Figure 6.15.
- Rectifier: A set of four diodes that convert the AC current into DC current. The rectifier is built into the stator and it is not serviceable.

78/83/90 Series Horizontal Shaft Engines

Charging system testing

To test the charging system:

1. Locate the charger harness. It will be by the right handle bar of the snow thrower when the engine is installed. See Figure 6.16.
2. Start the engine and run it at full throttle.

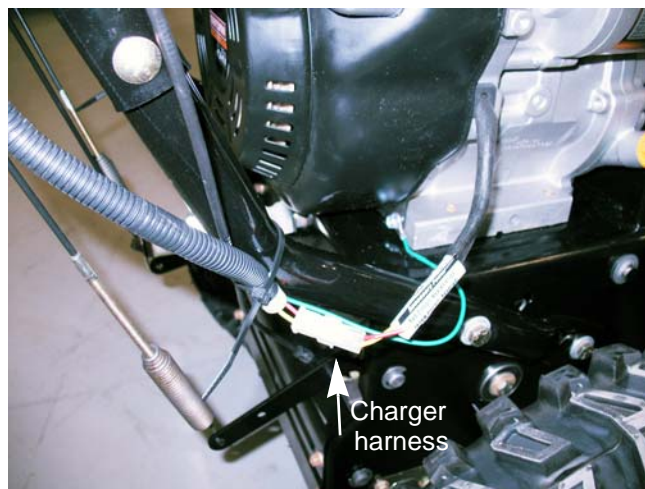

Figure 6.16

3. Connect the black (-) lead of a digital multimeter to a good ground on the engine.
4. Set the multimeter to read AC voltage.
5. Back probe the yellow wire in the charger harness with the red (+) lead of the multimeter. See Figure 6.17.
6. The multimeter should read a voltage of 13 - 18Vac.

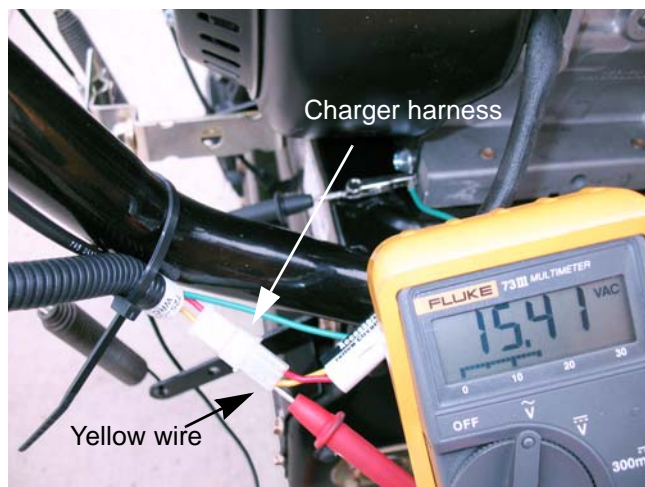

Figure 6.17

7. Set the multimeter read DC voltage.
8. Back probe the red wire of the charger harness. See Figure 6.18.
9. The multimeter should read 17 - 26Vdc.
10. If the results do not match what is listed above, check the magnets on the rotor.

NOTE: If the magnet are still magnetic, replace the stator.



Figure 6.18

Starter and Charging System

Stator

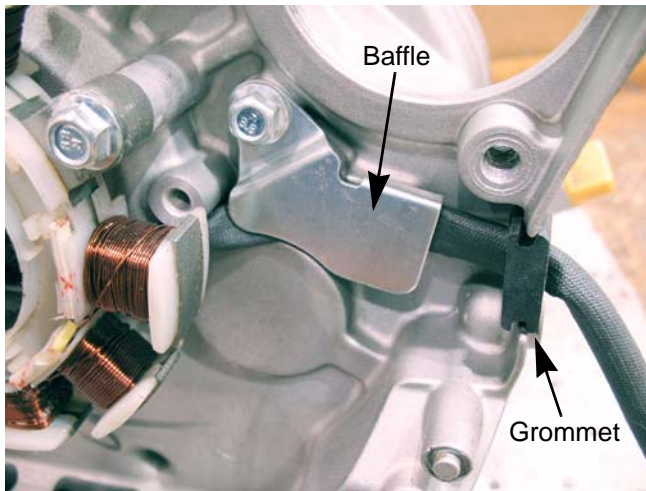

Figure 6.19

To remove/replace the stator:

1. Remove and ground the spark plug wire.
2. Remove the flywheel by following the steps described in Chapter 7: Ignition System.
3. Remove the baffle that covers the charger harness using a 10mm wrench. See Figure 6.19.
4. Slide the grommet out of the engine block. See Figure 6.19.

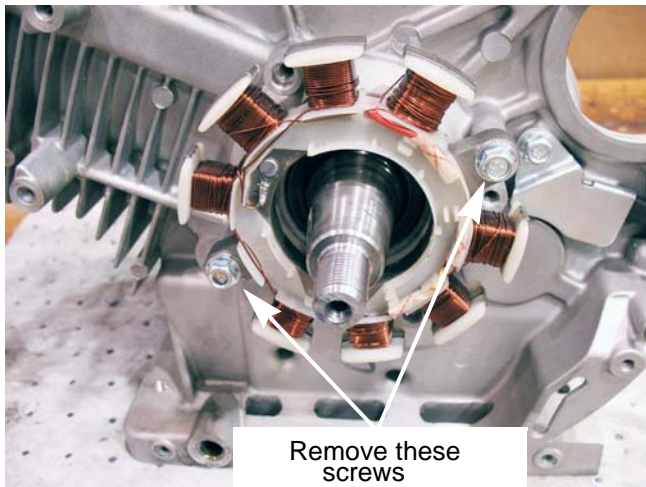

Figure 6.20

5. Remove the two screws that secure the stator with a 10mm wrench and lift the stator off of the engine. See Figure 6.20.
6. Install the stator by following the above steps in reverse order.
7. Test run the engine in a safe area and retest the voltage output before returning to service.

Rotor

Rotor failures are extremely rare.

To check the rotor:

- Confirm that the magnets are firmly attached to the flywheel.
- Hold a screwdriver or a similar tool made of ferrous metal within a 1/4" of each magnet.
- If the tool is drawn to the magnet, the rotor is good.

For Parts Call 606-678-9623 or 606-561-4983

78/83/90 Series Horizontal Shaft Engines

CHAPTER 7: IGNITION SYSTEM

Troubleshooting the ignition system

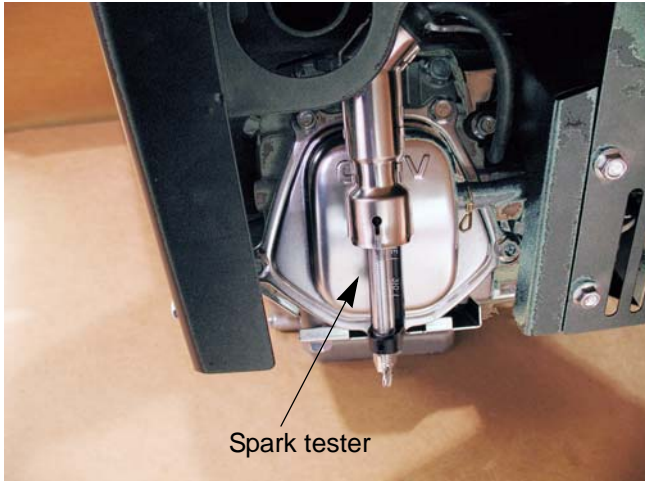

Figure 7.1

The purpose of the ignition system is to provide a spark in the combustion chamber at the proper time to efficiently ignite the fuel/air mixture. The steps in troubleshooting the ignition system are:

1. Examine the spark plug(s) by following the steps described in the spark plug section of this chapter.

NOTE: It is convenient to check the compression when the spark plug is removed for examination.

2. Connect a spark tester between the spark plug wire and a good ground point on the engine. See Figure 7.1.



CAUTION Never remove the spark plug and hold it against the cylinder head to test for spark. The fuel/air mix coming out of the spark plug hole will catch on fire.

NOTE: It only takes 1,000 volts to jump a 0.025" air gap in open atmosphere, it takes 10,000 volts to jump the same gap at 120 psi; therefore, an open air spark test is not valid.

NOTE: The spark should be a minimum of 10 Kv (10,000 volts) at pull over speed.

3. Make sure any remote stop switch is turned to the "run" position.
4. Pull the starter rope. If sparks can be seen in the spark tester, the ignition system is working.

NOTE: If there are sparks present in the spark tester, install a known-good spark plug and prime test the engine. If the engine does not start, check the fly wheel key. If the fly wheel key is intact, the problem is not in the ignition system. Check the engine's compression.

5. If no sparks or weak sparks are seen in the spark tester, use the electric starter to spin the engine.

NOTE: If sparks are now seen in the spark tester, check the module air gap. If no sparks are seen, further testing is required.

6. Test the stop switch by following the steps described in the stop switch section of this chapter.
7. If the stop switch is working properly, inspect the flywheel and flywheel key. If the flywheel and key are OK, replace the module.

78/83/90 Series Horizontal Shaft Engines

Stop switch

All MTD horizontal engines that are in use in North America have a stop switch built into the throttle lever assembly. MTD engines used on snow blowers have an additional stop (ignition) switch in the engine shroud.

To test the stop switch (throttle):

1. Remove the control panel by following the steps described in Chapter 3: Air Intake Systems.
2. Test the remote (ignition) stop switch first by following the procedures described in the next section of this chapter.
3. Disconnect the lead that runs from the module to the stop switch. See Figure 7.2.

NOTE: The blower housing was removed for picture clarity.

4. Connect one lead of a digital multimeter to the lead going to the stop switch. Connect the other lead of the digital multimeter to a good ground.
 5. Set the multimeter to the ohms (Ω) scale.
 6. Operate the throttle lever while watching the multimeter.
- When the throttle is all the way to the right (stop), the multimeter should read at or near 0.0Ω , indicating continuity. See Figure 7.3.

- When the throttle is all the way to the left (full throttle), the multimeter should not show continuity. See Figure 7.4.

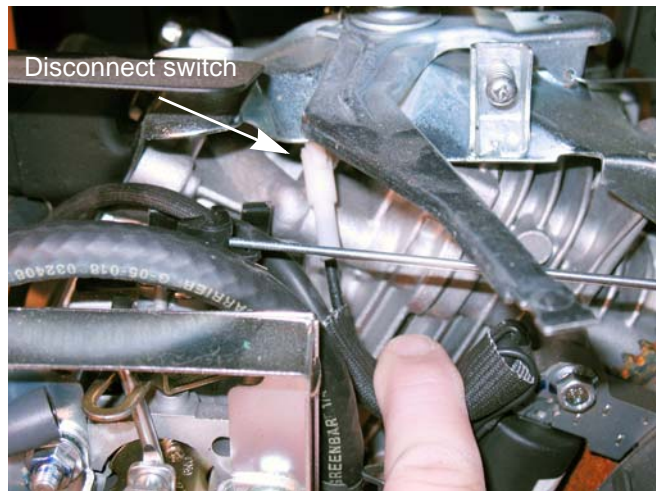

Figure 7.2

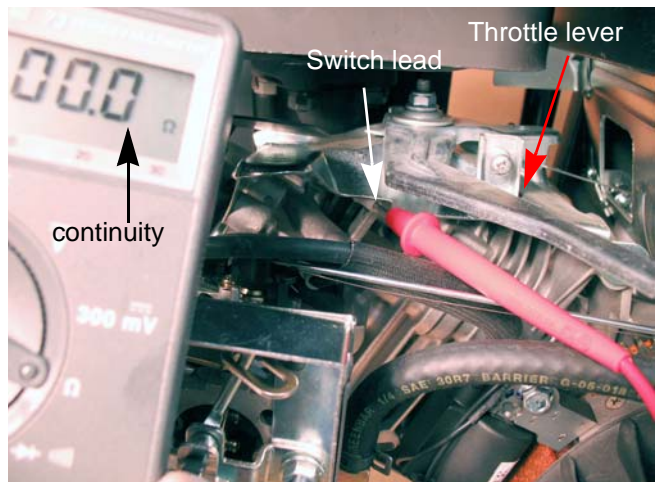

Figure 7.3



Figure 7.4

Remote (ignition) stop switch (snow engines)

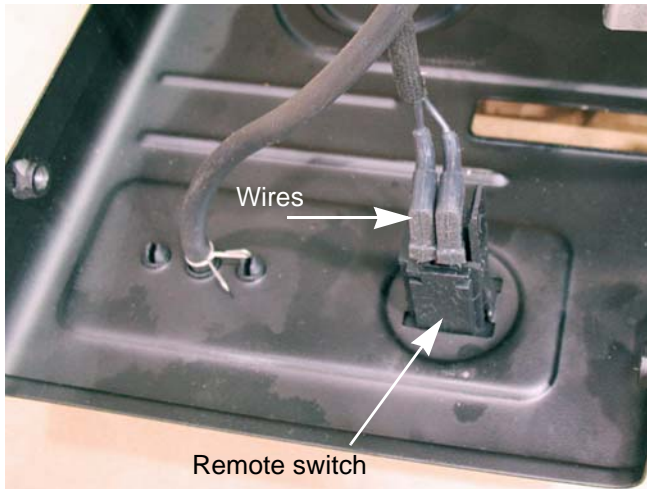

Figure 7.5

To test the remote stop switch:

1. Remove the engine shroud by following the procedures described in Chapter 3: Air Intake System.
2. Disconnect the two wires from the remote switch. See Figure 7.5.



Figure 7.6

3. Connect a digital multimeter to the two tabs on the back of the remote switch.
4. Set the multimeter to the ohms (Ω) scale.
 - With the key fully inserted, the multimeter should not show continuity. See Figure 7.6.



Figure 7.7

- With the key removed, the meter should show continuity. See Figure 7.7.
5. If the test results do not match the results described in step 4, replace the remote switch.

78/83/90 Series Horizontal Shaft Engines

Test for ignition that won't turn off

MTD engines are turned off by removing the spark from the engine. This is accomplished by shorting the primary windings of the coil to ground.

If the engine does not stop when the key is removed and/or the throttle is moved to the stop position:

1. Test the stop switch and the remote ignition switch by following the procedures described in the previous sections of this chapter.

NOTE: If the switches are working properly, leave the front engine shroud off.

2. Remove the blower housing.
3. Move the throttle to the wide open throttle (rabbit) position.
4. Connect one lead of the multimeter to one of the wires that goes to the remote switch.

NOTE: One wire will go to one of the module screws to provide a ground path. The other wire goes to the primary winding of the coil.

5. Set the multimeter to the ohms (Ω) scale.
6. Connect the other lead of the multimeter to a good ground. See Figure 7.8.

7. Repeat steps 6 - 8 on the other wire. See Figure 7.9.

- The ground wire should have a resistance reading of 0.2Ω or less. If the reading is $> 0.2 \Omega$, check the ground at the module and check the wire for a fault.
- The wire that goes to the primary windings of the coil should have a resistance reading of approximately 1.0Ω . If the reading is $> 1.2 \Omega$, replace the coil.

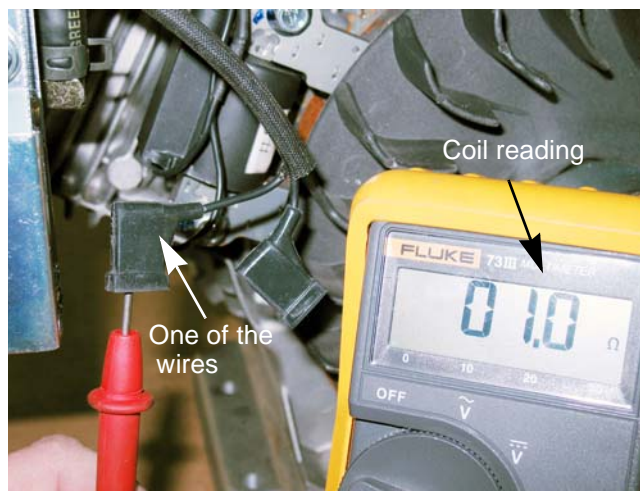

Figure 7.8

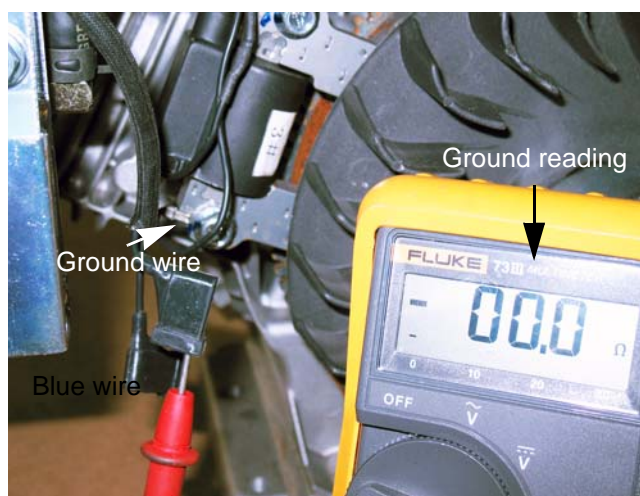

Figure 7.9

The module

The coil in this ignition system is an inductive discharge magneto, contained in a single module.

- The inductive discharge magneto has a two leg design.
- The magneto is energized by the passing of a magnet mounted in the flywheel.
- Ignition timing is set by the location of the flywheel in relation to the crankshaft. Proper timing is maintained by a steel key.

Normal performance of the coil is to produce at least 10,000 volts at starter-rope pull-through speed.

The presence or absence of strong spark, with the stop switch known to be good, is generally enough to identify the ignition coil as good or bad. Resistance readings may help confirm the source of the failure, but are generally meaningless because they only measure a small part of the module.

NOTE: No spark or a weak spark may be the result of an improper air gap. The air gap space should be 0.016"-0.024" (0.4-0.6mm).

Simple spark-testers are readily available and inexpensive. Thexton Part # 404 is available from a variety of retailers, and similar tools are available from other manufacturers. See Figure 7.10.



Figure 7.10

NOTE: If the complaint is that the engine quits running when it gets warm, the ignition module should be tested with the engine at normal operating temperature.

- At operating speed, the ignition should produce voltage approaching 12,000.
- At pull-over speed (\approx 600 RPM), voltage should be at least 10,000V.

NOTE: The voltage required for a flash-over will vary with spark plug condition and gap.

NOTE: Pull-over speed may vary from operator to operator.

NOTE: Failure of the magnets in the flywheel is exceedingly rare. To test the magnets, simply hold an item made of ferrous metal roughly 1/4" (0.635cm) away from the magnets in the flywheel. It should be drawn to the flywheel. A wrench or screwdriver is suitable for this test.

78/83/90 Series Horizontal Shaft Engines

Module removal

1. Unplug the spark plug.
2. Remove the engine shroud by following the steps procedures in Chapter 3: Air Intake Systems.
3. Remove the front fuel tank shroud using a 10 mm wrench. See Figure 7.11.

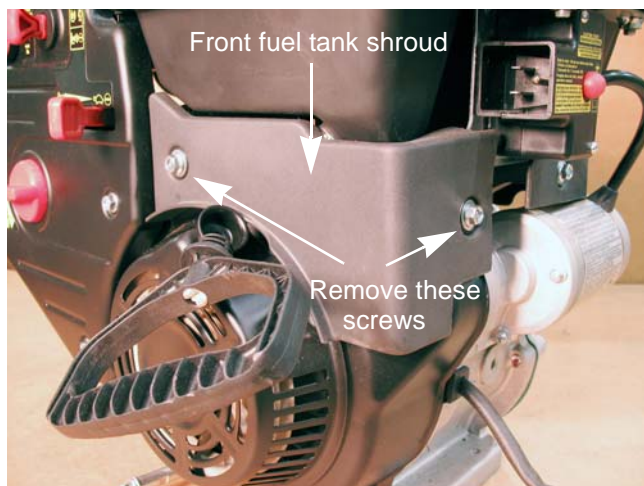

Figure 7.11

4. Remove the blower housing.
NOTE: The recoil starter will come off with the blower housing.
5. Unhook the spark plug wire from the clip in the carburetor insulator. See Figure 7.12.
6. Disconnect the leads that runs from the module to the stop switches. See Figure 7.11.
7. Remove the module using a 10mm wrench.

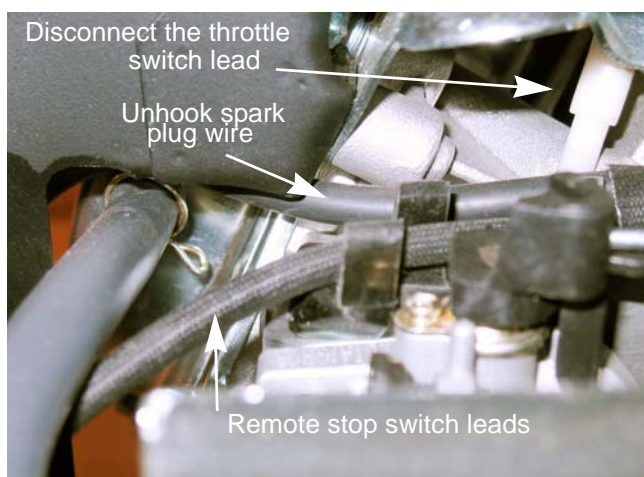

Figure 7.12

Installing the module and setting the air gap

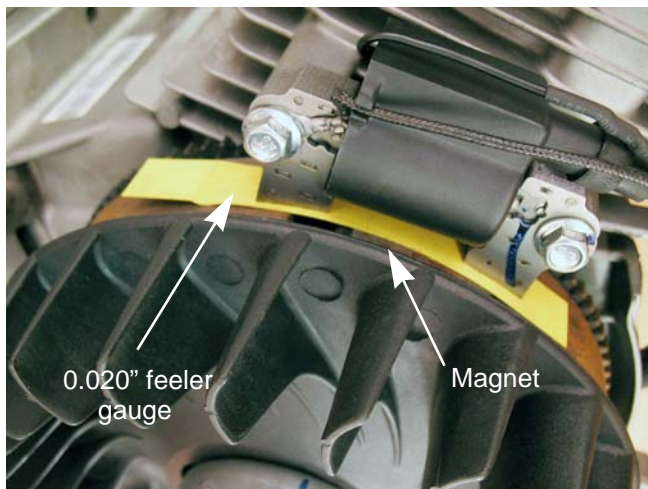

Figure 7.13

NOTE: If just setting the air gap, loosen the module mounting screws first then follow the same steps as described below.

1. Rotate the flywheel so that the magnets are away from where the module is mounted.
2. Install the module. Do not tighten the module down.
3. Place a non-ferrous feeler gauge between the module and the flywheel.

NOTE: The air gap should be 0.016" - 0.024" (0.4-0.6 mm).

4. Rotate the flywheel so that the magnets align with the legs of the module while holding the feeler gauge in place. See Figure 7.13.
5. Tighten the module mounting screws to a torque of 80 - 106 in-lbs (9 - 12 Nm).

6. Rotate the flywheel to remove the feeler gauge.
7. Install the blower housing and starter.
8. Hook the spark plug wire from the clip in the carburetor insulator.
9. Install the Heat box and intake elbow by following the steps described in Chapter 3: Air Intake Systems.
10. Connect the spark plug wire to the spark plug.
11. Test run the engine before returning to service.

78/83/90 Series Horizontal Shaft Engines

Flywheel

The flywheel holds the magnets. These magnets induce a field in the module which in turn produces a spark. It also controls the timing of the ignition system by controlling when the magnets are introduced to the module.

A sheared flywheel key will throw off the ignition timing. Sheared keys are uncommon on MTD engines. If one is found, check the crankshaft and flywheel for damage. To Remove and/or inspect the flywheel and key:

1. Remove the blower housing.
 - 1a. Remove the engine shroud by following the steps procedures in Chapter 3: Air Intake Systems
 - 1b. Remove the front fuel tank shroud using a 10 mm wrench.
 - 1c. Remove the five screws securing the blower housing and slide it off of the engine.
2. Block the piston to prevent the crank shaft from turning by:
 - 2a. Remove the spark plug.
 - 2b. Insert approximately 3.5 feet of starter rope in the spark plug hole.

IMPORTANT: Leave part of the rope sticking out of the engine so that the rope can be removed later.

3. Remove the flywheel nut, starter cup and flywheel fan using a 23mm wrench.
4. Remove the flywheel by applying a sharp blow to the crankshaft using a brass drift punch and a hammer while gently prying with a pry bar. The flywheel will loosen then lift it off.

NOTE: The magnets on the inside of the magnet will hold it down, preventing the typical “pop” when the flywheel loosens from the taper on the crankshaft.

NOTE: Never strike the crankshaft directly with a hammer. To prevent damage to the crankshaft use a brass drift punch or a piece of wood between the hammer and the crankshaft. See Figure 7.14.

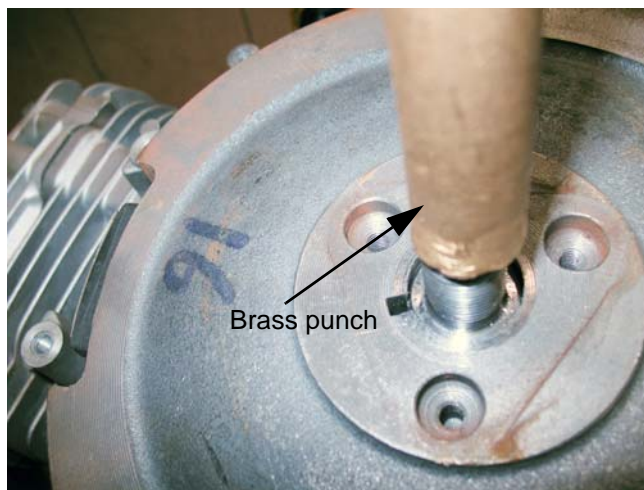

Figure 7.14



If the flywheel shows any signs of physical damage such as cracks, broken vanes, or damaged key-way, replace it. A damaged flywheel poses a threat of burst failure. Burst failures are extremely hazardous to surrounding people and property.

5. Inspect the key, keyway, and tapered mating surfaces of the flywheel and crankshaft.

NOTE: If the key is damaged, it must be replaced. If there is damage to the crankshaft, the engine must be short blocked because the crankshaft is not available as a service part.

NOTE: On installation, confirm that the key is properly seated (the flat of the key parallel with the threaded section of the crankshaft) in the keyway, and that the tapers are fully seated. Key or keyway failure may result from improper seating.

IMPORTANT: The tapers in flywheel and on the crankshaft must be clean and dry. The flywheel is held in place by the friction between the flywheel and the crankshaft, not the key. The key is only to guide the flywheel to the proper position until it is torqued down.
6. Install the flywheel nut to a torque of 66-81 ft-lbs (90-110Nm).
7. Adjust the air gap by following the steps described in the previous section of this chapter.
8. Reassemble the engine.
9. Test run the engine before returning to service.

About the spark plug

- The spark plug is a F6RTC, gapped to 0.026" - 0.030" (0.65 - 0.75 mm).

NOTE: The F6RTC plug is the only plug that is EPA certified for the MTD engine.

- Wear rate will vary somewhat with severity of use. If the edges of the center electrode are rounded-off, or any other apparent wear / damage occurs, replace the spark plug before operating failure (no start) occurs.

Cleaning the spark plug

- Cleaning the spark plug is not recommended. If the plug needs to be cleaned, replace it.
- Use of a wire brush may leave metal deposits on the insulator that cause the spark plug to short-out and fail to spark.
- Use of abrasive blast for cleaning may damage the ceramic insulator or leave blast media in the recesses of the spark plug. When the media comes loose during engine operation, severe and non-warrantable engine damage may result.

Inspection of the spark plug

Inspection of the spark plug can provide indications of the operating condition of the engine.

- Light tan colored deposits on insulator and electrodes is normal.
- Dry, black deposits on the insulator and electrodes indicate an over-rich fuel / air mixture (too much fuel or not enough air)
- Wet, black deposits on the insulator and electrodes indicate the presence of oil in the combustion chamber.
- Heat damaged (melted electrodes / cracked insulator / metal transfer deposits) may indicate detonation.
- A spark plug that is wet with fuel indicates that fuel is present in the combustion chamber, but it is not being ignited.

Spark plug removal

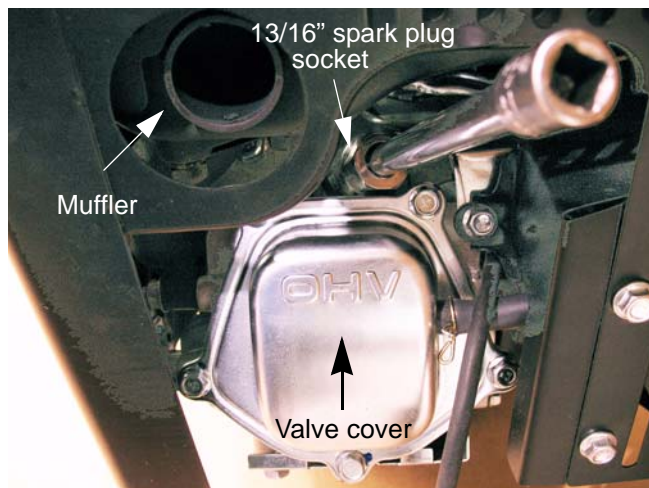

Figure 7.15

1. Disconnect and ground the spark plug wire.
2. Remove the spark plug using a 13/16" or 21mm wrench. A flexible coupling or "wobbly" extension may help. See Figure 7.15.
3. Gap a new spark plug to 0.026" - 0.030" (0.65 - 0.75 mm).
4. Install the new spark plug and tighten to a torque of 15 - 18 ft - lbs (20 - 25 Nm).

For Parts Call 606-678-9623 or 606-561-4983

78/83/90 Series Horizontal Shaft Engines

CHAPTER 8: EXHAUST

The exhaust system is a frequently overlooked component of an engine. It is important to make sure the muffler is in good condition and free of debris and/or insects.

NOTE: A blocked muffler will result in poor performance. If a muffler is completely blocked the engine may not start.

Summer engines

One of the main differences between the summer and the snow engines is the exhaust system. Because of this they will be addressed separately.

Spark arrester (if equipped)

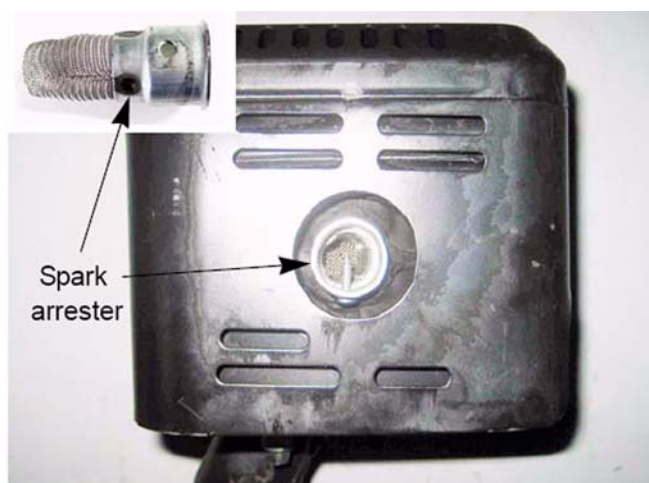

Figure 8.1

A spark arrester is available as an option on summer engines.

NOTE: Spark arrestors are an option that are required on all engines used in California and U.S. national parks. See Figure 8.1. Inset.

The spark arrester also serves to keep blockages out of the exhaust system.

NOTE: Typical blockages include insect nests built during the dormant season.

The spark arrester should be checked and/or cleaned every month. The spark arrester can be inspected by shining a flash light into the muffler. See Figure 8.1.

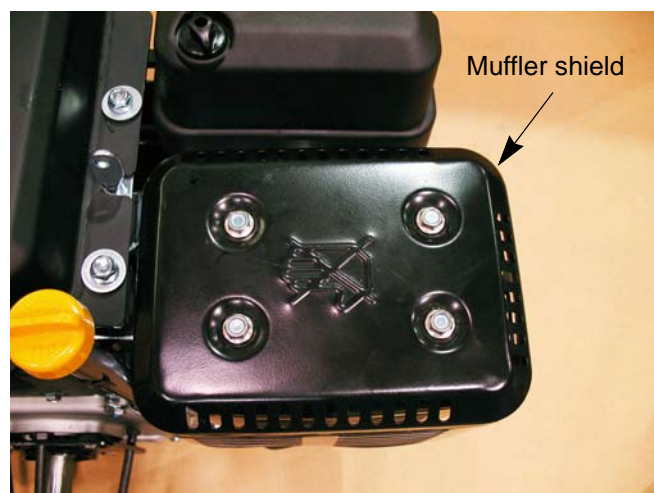

Figure 8.2

If The spark arrester needs to be cleaned or replaced:

1. Remove the four screws that retain the muffler shield using a 10mm wrench and lift it off of the engine. See Figure 8.2.
2. Remove the spark arrester retaining screw using a #2 phillips screwdriver. See Figure 8.1.
3. Pry the spark arrester out of the muffler.
4. The spark arrester can be:
 - Replaced
 - Cleaned by mechanical means
 - Solvent cleaned
 - Burned clean using a butane or propane torch.
5. Install the spark arrester by following steps 1-3 in reverse order.

78/83/90 Series Horizontal Shaft Engines

Muffler removal/replacement

1. Remove the two nuts that hold the manifold pipe to the cylinder head using a 13mm wrench. See Figure 8.3.
2. Lift the muffler off of the engine.

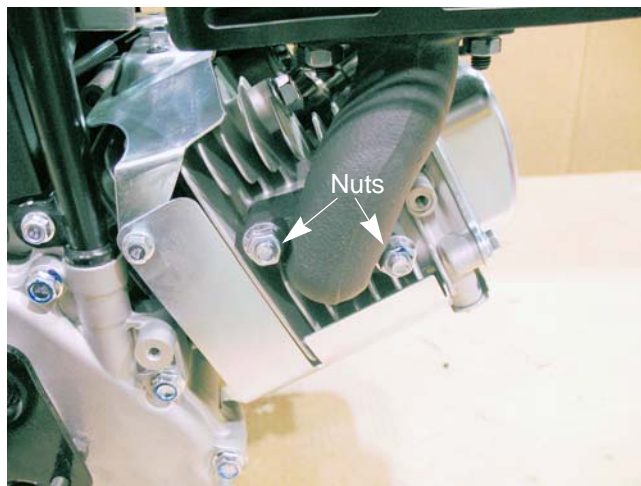

Figure 8.3

3. Clean all of the gasket material off of the cylinder head and the muffler. See Figure 8.4.

NOTE: The MTD engine uses a graphite exhaust gasket. It is not reusable and must be replaced every time the muffler nuts are loosened.

NOTE: The graphite exhaust gasket transfers heat from the cylinder head to the muffler. The heat transfer helps to keep the engine operating temperature under control. Do not substitute an exhaust gasket made from another material.

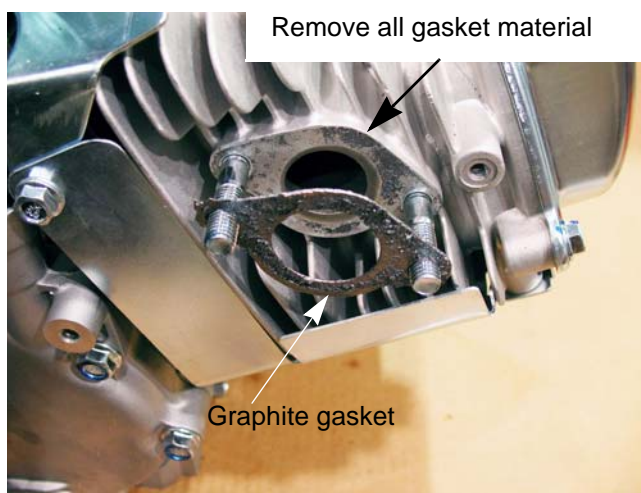

Figure 8.4

4. Disconnect the manifold pipe from the muffler using a 13mm wrench.
5. Clean all of the gasket material off of the manifold pipe and the muffler.

NOTE: If reusing the muffler skip to step #8

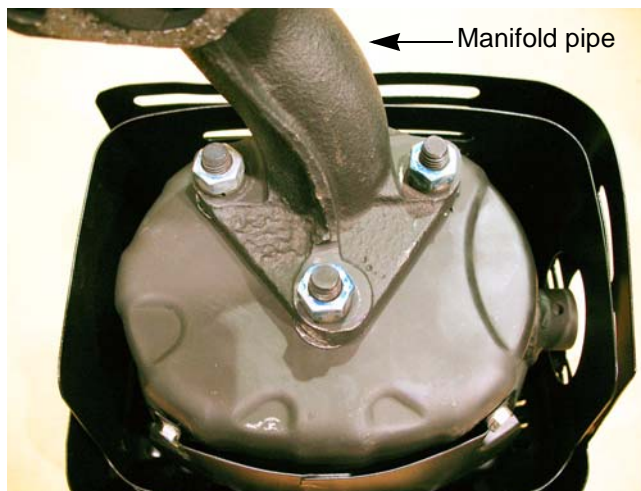

Figure 8.5



Outer heat shield

Figure 8.6

6. Remove the four screws that secure the outer heat shield to the muffler. See Figure 8.6.

7. Slide the outer heat shield off of the muffler.

NOTE: The inner heat shield is serviced with the muffler.

8. Install the muffler by following the previous steps in reverse order.

NOTE: Install a new gaskets between the muffler and the manifold pipe also between the manifold pipe and the cylinder head.

NOTE: Tighten the muffler and the manifold nuts to a torque of 13 - 16 ft-lbs (18 - 22 Nm).

9. Test run the engine before returning to service.

78/83/90 Series Horizontal Shaft Engines

Muffler removal/replacement (snow engines)

To remove/replace the muffler:

1. Remove the control panel by following the procedures described in Chapter 3: Air Intake System.
2. Remove the muffler heat shield by:
 - 2a. Remove the two rear heat shield screws using a 10 mm wrench. See Figure 8.7.



Figure 8.7

3. Remove the screw that holds the heat shield to the cylinder head using a 10 mm wrench. See Figure 8.8.

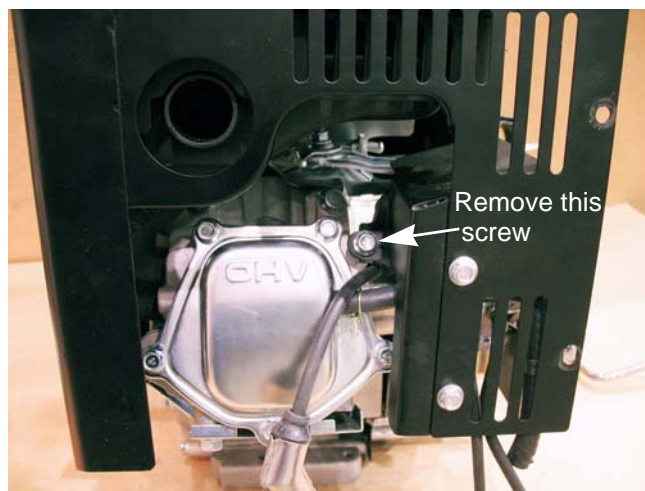

Figure 8.8

4. Work the heat shield off of the engine.
5. Remove the three screws that secure the exhaust pipe shield using a 10 mm wrench. See Figure 8.9.

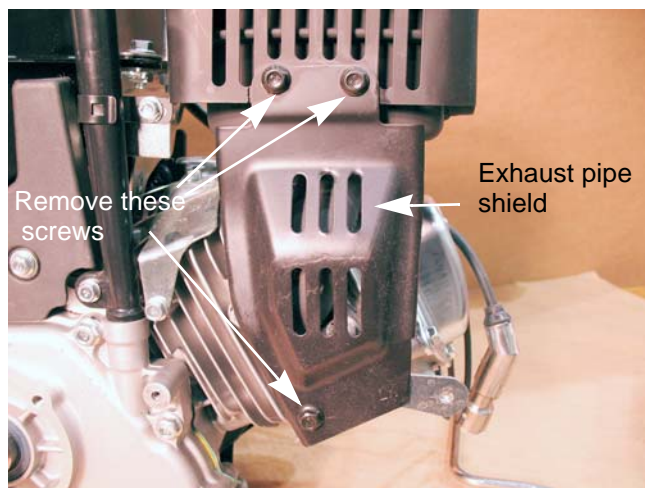

Figure 8.9

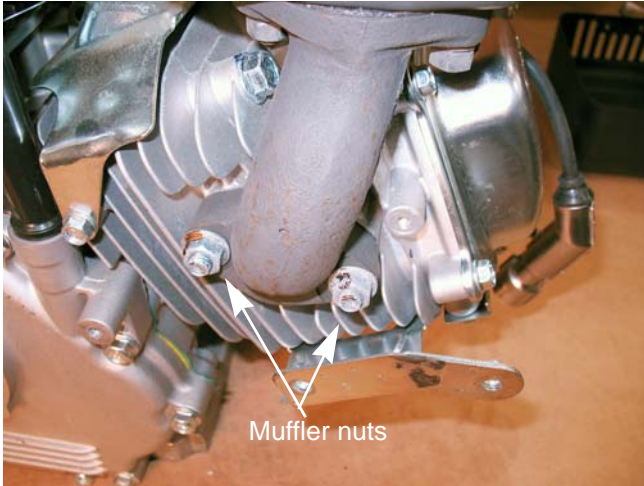

Figure 8.10

6. Remove the two muffer nuts using a 13mm wrench and lift the muffer off of the engine. See Figure 8.10.

7. Clean all of the gasket material off of the cylinder head and the muffer (if reusing the muffer)

NOTE: The MTD engine uses a graphite exhaust gasket. It is not reusable and must be replaced every time the muffer nuts are loosened.

8. Install a new gasket.

9. Install the muffer and tighten the muffer nuts to a torque of 13 - 16 ft-lbs (18-22 Nm).

10. Test run the engine before returning to service.

For Parts Call 606-678-9623 or 606-561-4983

78/83/90 Series Horizontal Shaft Engines

CHAPTER 9: CYLINDER HEAD

Cylinder head removal



Figure 9.1

The Cylinder head of the MTD engine can be removed without removing the engine from the piece of equipment.

To remove the cylinder head:

1. Disconnect and ground the spark plug high tension lead.
2. Remove the spark plug using a 13/16" or 21mm wrench.
3. Rotate the crankshaft until it is at TDC of the compression stroke by following the steps described in the valve lash section of Chapter 1: Introduction.
4. Remove the muffler and heat shield by following the steps described in Chapter 8: Exhaust.
5. Remove the control panel, carburetor and insulator plate by following the steps described in Chapter 3: Air Intake Systems.
6. Remove the two screws that secure the upper left side of the blower housing. See Figure 9.1.
7. Remove the heat baffle. See Figure 9.2.

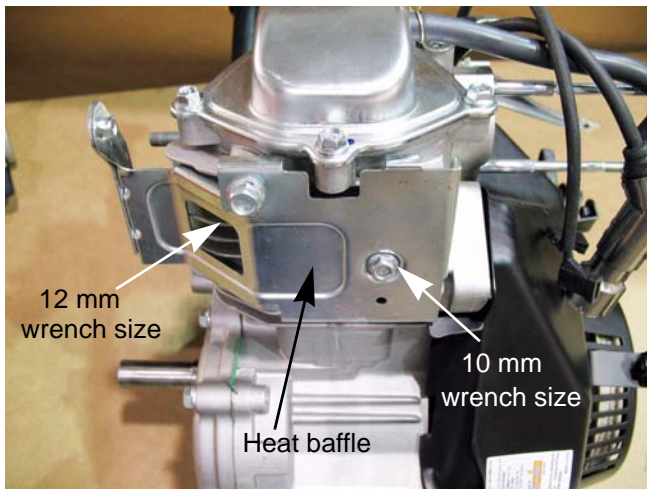

Figure 9.2

78/83/90 Series Horizontal Shaft Engines

8. Remove the screw that fastens the throttle lever to the rear of the cylinder head using a 10 mm wrench. See Figure 9.3.

NOTE: The throttle lever can be disconnected and removed from the engine or moved to the side.



Figure 9.3

9. Remove the five screws securing the valve cover using a 10mm wrench. See Figure 9.4.
10. Loosen the jam nuts and fulcrum nuts that secure the rocker arms using a 10mm wrench and a 14mm wrench.
11. Pivot the rocker arms aside, or remove them completely, and remove the push rods.

NOTE: Once broken-in, the rocker arm should be kept with its corresponding valve.

NOTE: The intake and exhaust push rods are identical and interchangeable. It is preferable, but not absolutely necessary, to return the same push rods to their original locations on engine with substantial (≥ 100 hours) operating time.

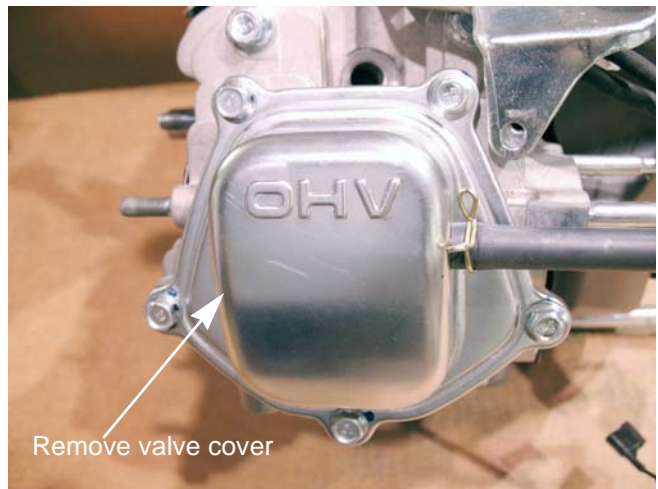

Figure 9.4

12. If replacing the head, double-nut and remove the exhaust and carburetor studs.
13. Remove the cylinder head bolts using a 12mm wrench. See Figure 9.5.



Figure 9.5

Cylinder head

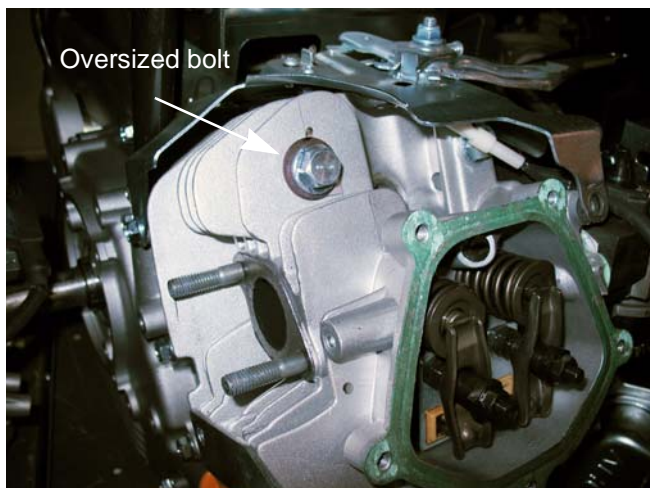

Figure 9.6

NOTE: The 490 engine has an over sized bolt with a Belleville washer in the number 4 position. The wrench size and torque is the same as the other three bolts. See Figure 9.6.

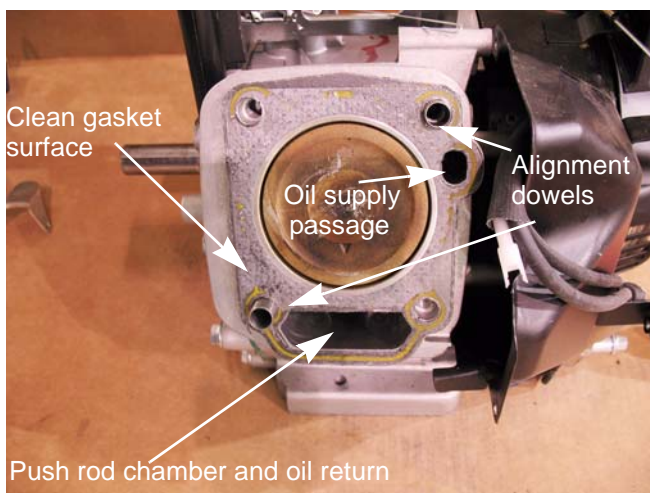

Figure 9.7

14. Lift the cylinder head off of the engine.
15. Carefully clean all sealing surfaces of all gasket residue. Do not scratch the sealing surfaces. See Figure 9.7.

NOTE: Make a visual inspection of the valves and cylinder bore to confirm the initial diagnosis.

78/83/90 Series Horizontal Shaft Engines

Cylinder head installation

1. Place a new head gasket on the cylinder, allowing the alignment dowels to hold it in place. See Figure 9.8.

NOTE: MTD uses graphite head gaskets that have a bead of silicon on them. They are not reusable.

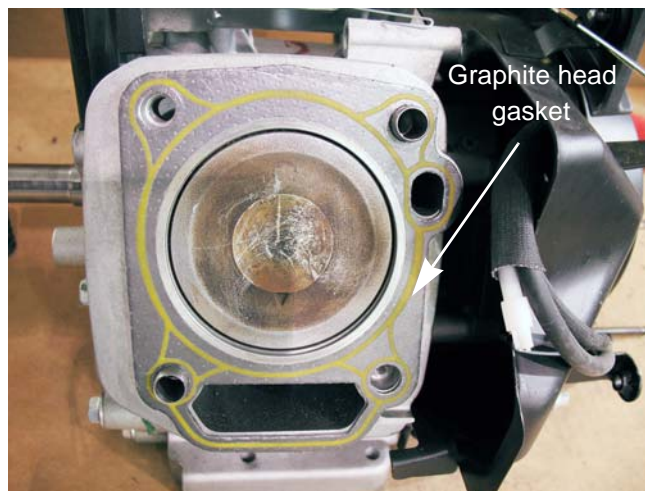

Figure 9.8

2. Position the cylinder head on the engine block.
3. Install the 4 head bolts, and tighten them to a step torque of 38 - 41 ft-lb. (52 - 55 Nm) in an alternating diagonal pattern. See Figure 9.9.

NOTE: The bolt closest to the exhaust valve must be the last bolt tightened. Failure to do so will result in the head bolt loosening up.

NOTE: The 490 engine has an over sized bolt with a Belleville washer in the number 4 position.

4. Insert the push rods.
5. Install the rocker arms.
6. Adjust the valve lash by following the steps described in Chapter 1: Introduction.
7. Install the throttle lever and the heat baffle.
8. Install the muffler by following the steps described in Chapter 8: Exhaust.
9. Install the carburetor and engine shroud, using new gaskets, by following the steps described in Chapter 3: Air Intake
10. Test run the equipment in a safe area before returning it to service. Check all safety features.

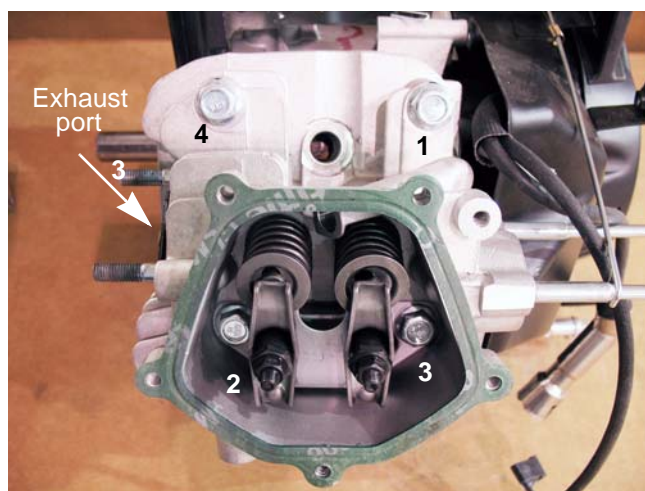

Figure 9.9

Valves

The valves and valve seats can be serviced by grinding and lapping or the head can be replaced. Depending on local machine and labor costs, it is probably more economical to replace the cylinder head versus servicing the valves.



Figure 9.10

To service the valves:

NOTE: Servicing valves during the warranty period will void the warranty. Warranty valve repairs are to be accomplished by replacing the cylinder head.

1. Remove the cylinder head by following the steps described earlier in this chapter.
2. Remove the rocker arms by:
 - 2a. Remove the jam nuts.
 - 2b. Remove the fulcrum nut.
 - 2c. Slide the rocker arms off of the rocker studs.
3. Remove the valve retainers by applying light finger pressure and moving the retainer so that the valve stem passes through the large part of the "keyhole" opening in the retainer. See Figure 9.10.

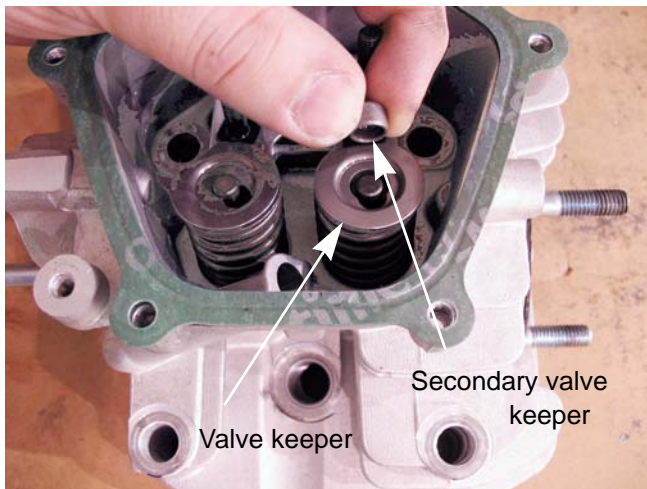

Figure 9.11

NOTE: The valve keepers are not interchangeable.

NOTE: The exhaust valve has a cap called an "adjuster" on it. The cap needs to be pulled off before the keeper can be removed. See Figure 9.11.

NOTE: If the engine has a dropped valve, remove the cylinder head, inspect the valve and the piston for damage.

78/83/90 Series Horizontal Shaft Engines

4. Lift the springs off of the valve stems.
 5. Slide the valves out of the cylinder head.
- NOTE:** Only the intake valve has a valve guide seal.
See Figure 9.12.

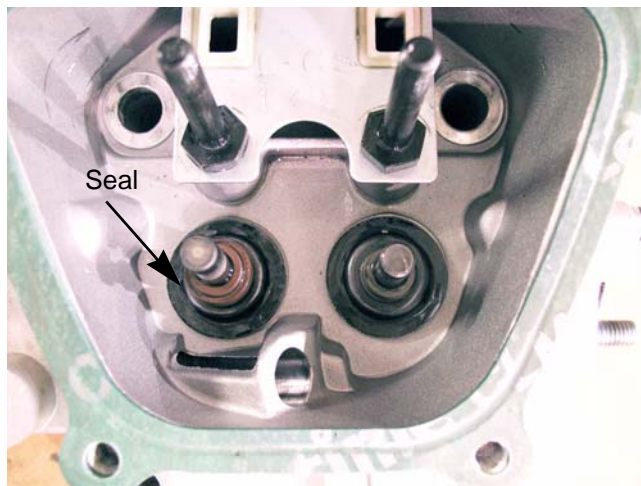

Figure 9.12

6. Inspect the valve seat. See Figure 9.13.
 - Valve seats are 45 degrees, with a 31 degree topping cut and a 61 degree narrowing cut.
 - Seat width should be 0.028" - 0.035" (0.7 - 0.9mm) with a margin of 0.024" (0.6mm) on the exhaust valve and 0.027" (0.7mm) on the intake valve.

NOTE: The valve seat can be ground to clean it up as long as the finished seat is within the tolerances listed above.

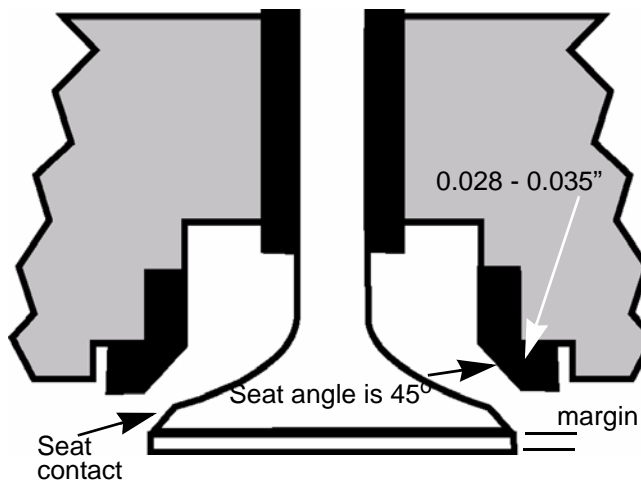

Figure 9.13

7. Inspect the valve stem. See Figure 9.14.
 8. Inspect the valve springs.
- NOTE:** Valve spring free length should be at least 1.22" (28.5mm). Original length is 1.44" (36.6mm).
9. Install the valves in the cylinder head by following steps 2 - 5 in reverse order.

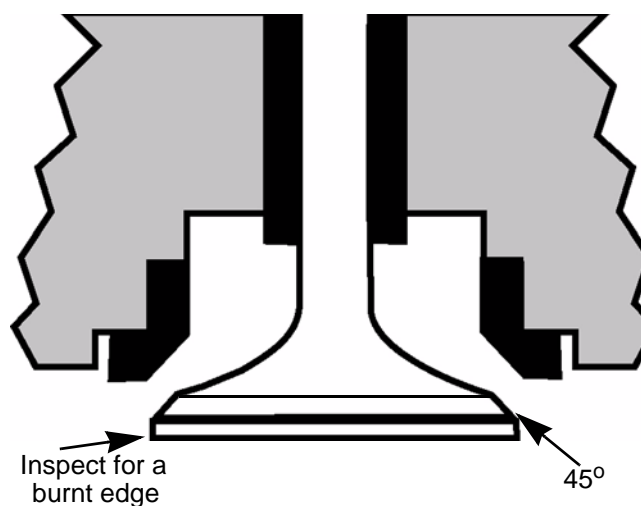

Figure 9.14

10. Test the valves for leaks by:
 - 10a. Place the cylinder head on a couple of wood blocks with the valves facing up.
 - 10b. Pour a small amount of gasoline or parts cleaning solvent into the combustion chamber (just enough to cover the valves).
 - 10c. Let the cylinder head sit for ten minutes.
 - 10d. Check for gasoline leaking out of the intake and exhaust ports.
11. Install the cylinder head by following the steps described earlier in this chapter.
12. Set the valve lash by following the steps described in Chapter 1: Introduction.
13. Test run the engine in a safe area before returning it to service. Check all safety features.

For Parts Call 606-678-9623 or 606-561-4983

78/83/90 Series Horizontal Shaft Engines

CHAPTER 10: CRANKSHAFT, PISTON AND CONNECTING ROD

The exact procedure a technician uses to disassemble an engine depends on the type of repairs needed. This chapter is written as a set of procedures that should provide the user with sufficient information to complete any feasible repair to the engine short block assembly.

The instructions are written with the assumption that the engine has been removed from the equipment. These are bench work instructions..

1. Drain and save the oil from the engine by following the steps described in Chapter 1: Introduction.
2. Remove the fuel tank by following the steps described in Chapter 4: Fuel system and Governor.
3. Remove the air intake and carburetor by following the steps described in Chapter 3: Air Intake Systems.
4. Remove the starter by following the steps described in Chapter 6: Starter and Charging Systems.
5. Remove the flywheel and ignition module by following the steps described in Chapter 7: Ignition system.
6. Remove the muffler by following the steps described in Chapter 8: Exhaust.
7. Remove the cylinder head by following the steps described in Chapter 9: Cylinder Head.
8. Remove the dipstick tube.
9. Remove the crank case cover bolts using a 12mm wrench.
10. Carefully slide the crank case cover off of the crank shaft.
11. Align the timing marks to allow easier removal of the cam shaft and to help protect the compression relief from damage. See Figure 10.1.

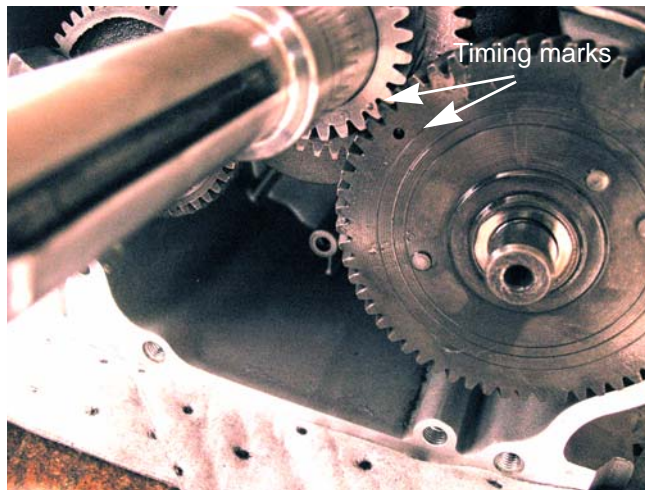

Figure 10.1

78/83/90 Series Horizontal Shaft Engines

12. Remove the camshaft.
13. Remove the balance shaft. See Figure 10.2.

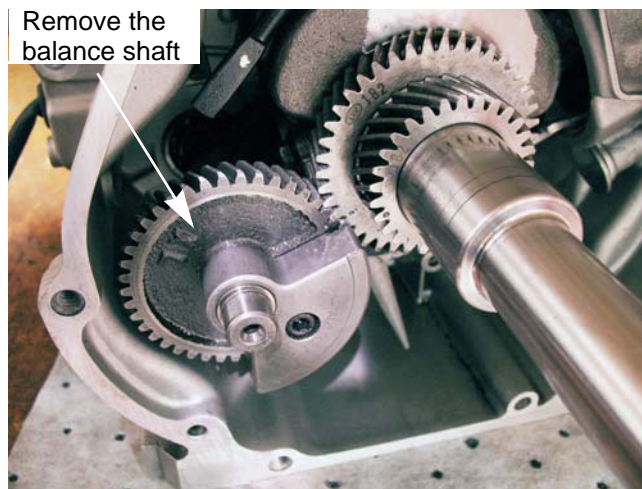

Figure 10.2

NOTE: The valve tappet should be kept riding against their original lobes. Once broken in, switching the tappets to run on different cam lobes will cause rapid tappet and cam wear.

14. Remove the valve tappets. See Figure 10.3.

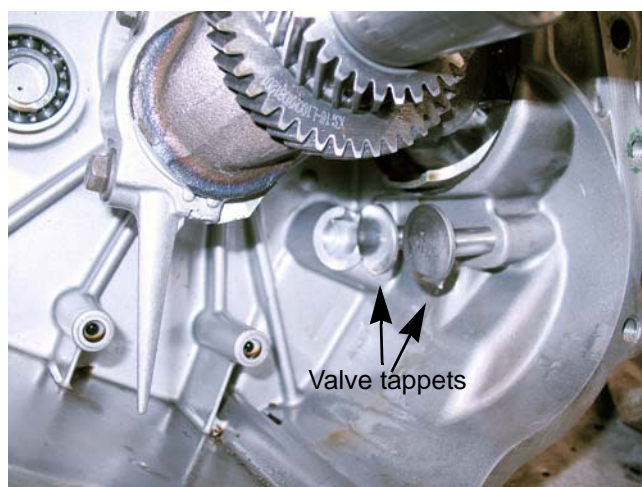

Figure 10.3

15. Remove the connecting rod cap using a 10mm wrench. See Figure 10.4.

NOTE: Rotating the crank shaft after the connecting rod bolts are removed will help to separate the connecting rod from the cap.

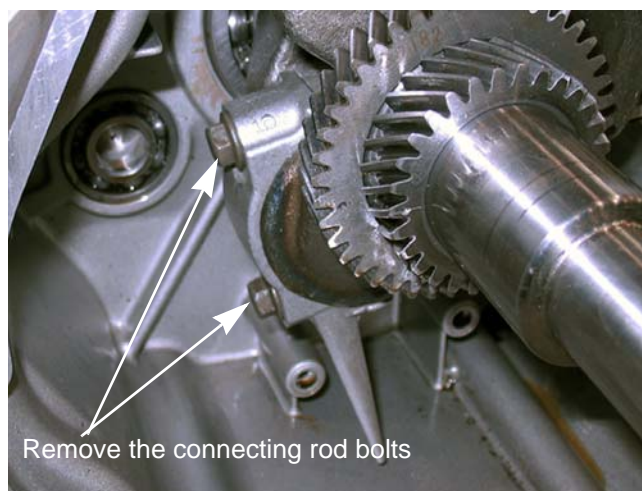

Figure 10.4

Crankshaft, piston and connecting rod

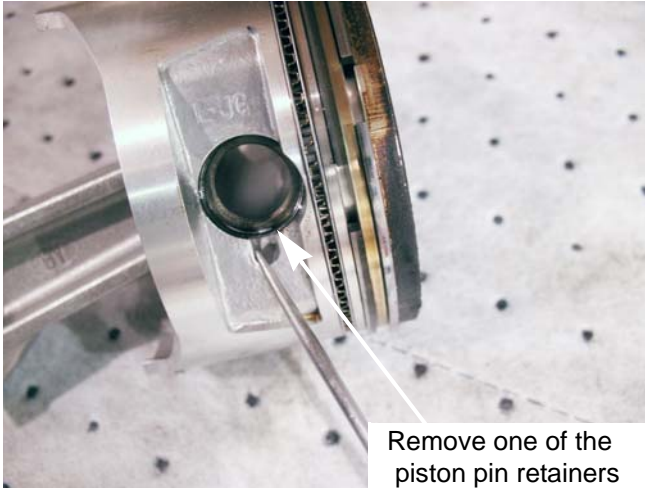

Figure 10.5



Figure 10.6

16. Push the piston out of the cylinder.

NOTE: Sometimes a ridge of carbon builds up where the cylinder meets the head. If this happens, the piston can be removed from inside of the cylinder block.

17. Remove one of the piston pin retaining rings.
See Figure 10.5.

18. Remove the piston pin.

19. Remove the piston rings from the piston using a pair of piston ring pliers. See Figure 10.6.

NOTE: The piston, rings and connecting rod are currently not available as service parts. If they are damaged or worn, the engine must be short blocked.

20. Remove the crankshaft.

NOTE: The crankshaft bearings are pressed onto the crankshaft and will come out with it.

78/83/90 Series Horizontal Shaft Engines

Crankshaft inspection

1. Inspect the crankshaft journals and the crank pin for galling, scoring, pitting or any other form of damage.

NOTE: This is mostly a visual check. Measurement is to determine if it is within the specifications after it is found to be OK visually.

NOTE: The crankshaft and bearing are serviced as one assembly.

2. Measure the crank pin where the connecting rod attaches to the crankshaft using a vernier caliper or a micrometer. See Figure 10.7.

NOTE: Micrometers are the preferred way to measure the journals. Measure the center and the ends to check for tapering or egging.

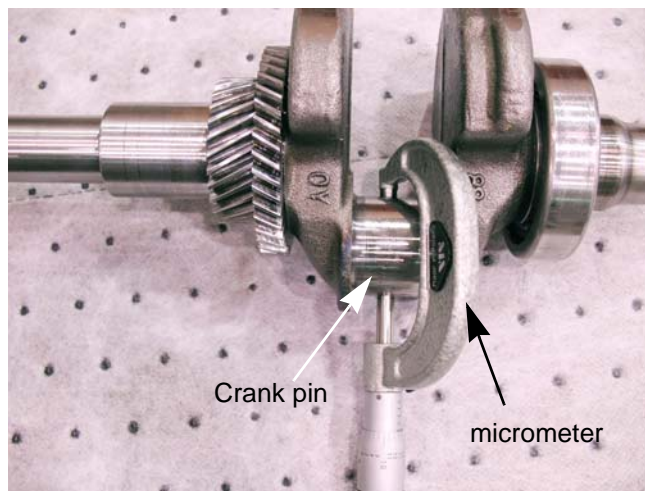

Figure 10.7

3. Check the crankshaft for straightness by measuring the run out. The crankshaft run out can be checked by:
 - 3a. Place the crankshaft on a pair of matched V-blocks or in the engine block with the sump installed.
 - 3b. Place a dial indicator at a smooth point at either end of the crank shaft.
 - 3c. Slowly turn the crank shaft while watching the dial indicator.

NOTE: Stop the crank shaft before the dial indicator hits the keyway.

 - 3d. Compare the reading on the dial indicator to the specification listed at the end of this chapter.
 - 3e. Repeat the above steps on the other end of the crank shaft.

Crankshaft, piston and connecting rod

Piston Inspection

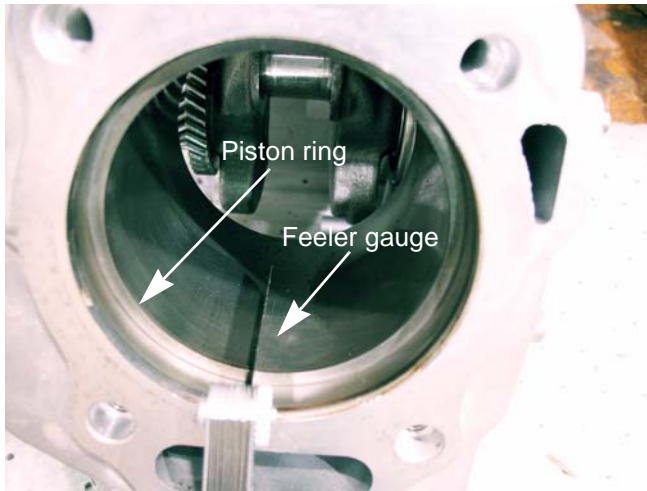

Figure 10.8

1. Clean the piston and remove all carbon from the rings and ring groves.
2. Clean the cylinder bore and remove all carbon.
3. Insert one ring into the cylinder. Push it down about one inch from the top. See Figure 10.8.
4. Measure the end gap with a feeler gauge and compare to the chart at the end of this chapter. See Figure 10.8.
5. Repeat steps 3 and 4 on the other rings.

NOTE: Piston rings are not available as service parts. If any of the end gaps are out of spec, the engine must be short blocked.

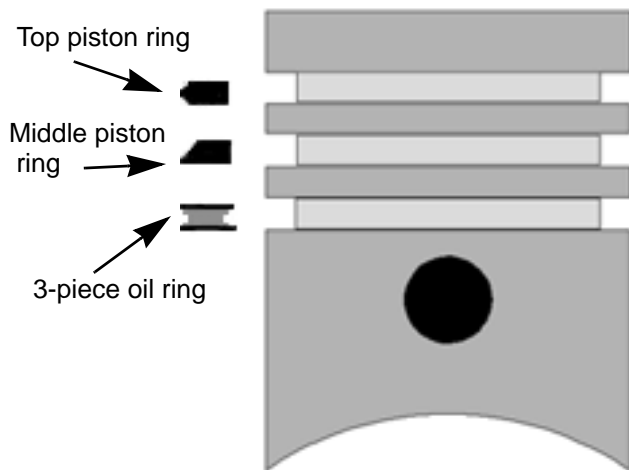

Figure 10.9

6. Install rings back onto the piston.

NOTE: The compression rings on the MTD engine have different profiles. It is important that the proper profiled ring is on the right groove. See Figure 10.9.



Figure 10.10

NOTE: To help identify the top surface of the middle piston ring, it has an "H" etched on it. See Figure 10.10.

78/83/90 Series Horizontal Shaft Engines

7. Measure the gap between the ring and the ring land using a feeler gauge and compare the measurement to the chart at the end of this chapter. See Figure 10.11.

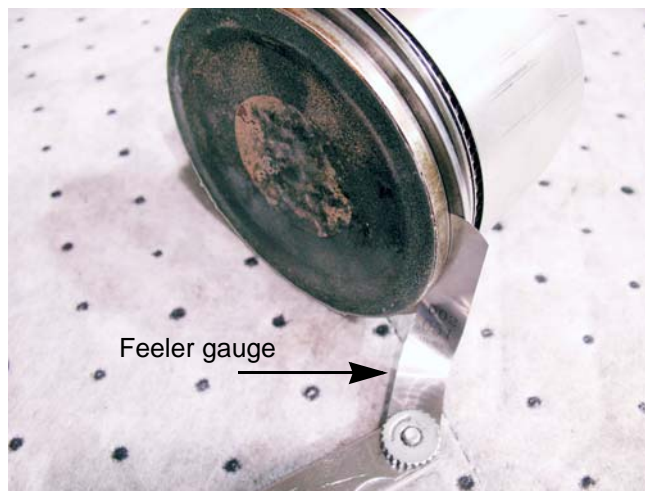

Figure 10.11

8. Measure the piston pin bore on both sides of the piston using telescoping gauges or vernier caliper. See Figure 10.12.

NOTE: Measurements should be taken at right angles to check the roundness of the holes.

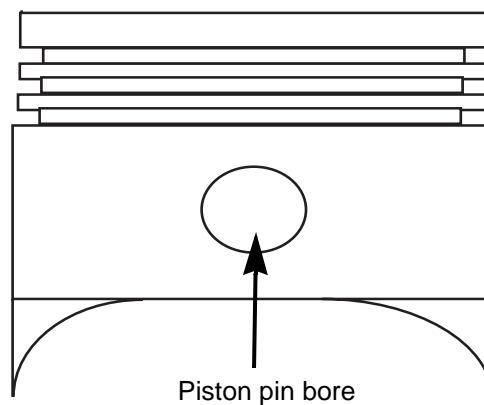

Figure 10.12

9. Measure the piston pin at the center and the ends using a micrometer or a vernier caliper. See Figure 10.13.



Figure 10.13

Crankshaft, piston and connecting rod

Connecting rod inspection

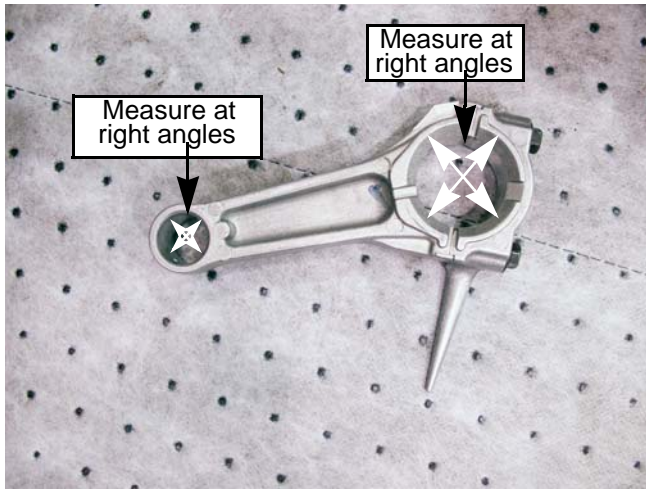

Figure 10.14

1. Inspect the connecting rod for cracks or any signs of damage.
2. Install the rod cap and tighten to a torque of 106 - 124 in-lbs (12 - 14Nm).
3. Measure the inside diameter of the connecting rod at both ends and compare the measurements to those listed in the chart at the end of this chapter. See Figure 10.14.

NOTE: Take two measurements 90 degrees apart. This will check the roundness of the connecting rod bearing surfaces.

NOTE: Connecting rods are not available as service parts. If the connecting rod is bad, the engine must be short blocked.

4. Take the crank pin and piston pin measurements and subtract them from the connecting rod measurements to get the connecting rod to journal running clearance and the piston pin to connecting rod running clearance. Compare that number to the one listed in the chart at the end of this chapter.

NOTE: Plasti-gauge can be used to measure the connecting rod to journal running clearance, but it is very technique sensitive and it is not as reliable as the method described above.

Cylinder inspection

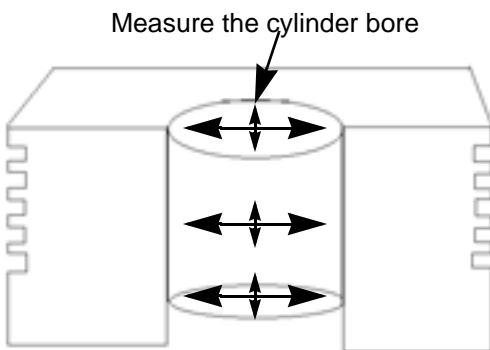

Figure 10.15

1. Clean and inspect the cylinder, inside and out.

NOTE: If there is any sign of damage, especially cracked cooling fins, short block the engine.

NOTE: Take two measurements of the cylinder bore 90 degrees apart at the top, bottom and middle of the cylinder. See Figure 10.15.

NOTE: The measurements can be made using telescoping gauges, inside micrometers or dial indicating bore gauge.

2. Compare the measurements to those that are listed in the chart at the end of the chapter.

- The bore should not be worn too large
- The bore should not be tapered.
- The bore should be round, not oval shaped.

3. Inspect the cylinder cross hatch.

NOTE: The cross hatch is important because it helps hold oil on the cylinder walls.

NOTE: If the cross hatch is polished off, that is a sign of dirt ingestion. The cylinder can not be re-honed because replacement piston rings are not available. The engine must be short blocked.

78/83/90 Series Horizontal Shaft Engines

Balance Shaft (483 & 490)

There are two primary motions that generate most of the vibrations in single-cylinder engines; the rotation of the crankshaft, and the reciprocating motion of the piston. See Figure 10.16.

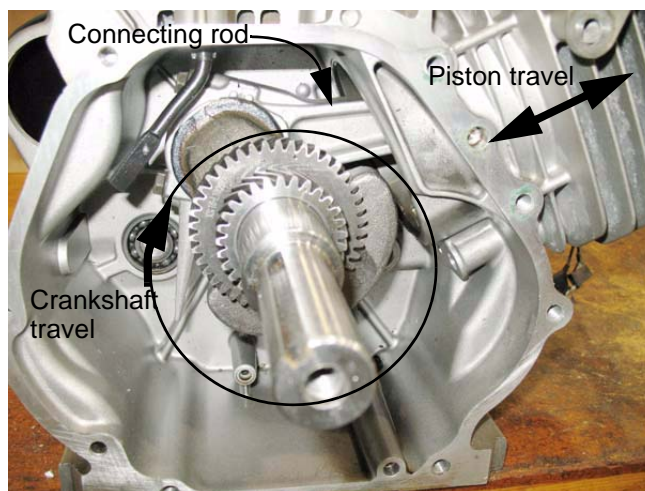

Figure 10.16

The connecting rod translates the linear motion of the piston to the rotating motion of the crankshaft. Two-thirds of its mass can be attributed to rotating motion, and one-third of its mass can be attributed to reciprocating motion. See Figure 10.17.

If you balance the rotational mass perfectly by adding weight to the crankshaft counter-weights, there will still be a large force generated by the reciprocating masses (the piston, piston pin and one-third of the connecting rod). The crankshafts on MTD engines are not balanced. Extra weight is added to the crankshaft counter-weight to reduce the total reciprocating and rotational forces. This causes the engine to shake side to side (perpendicular to the crankshaft), but reduces overall vibrations.

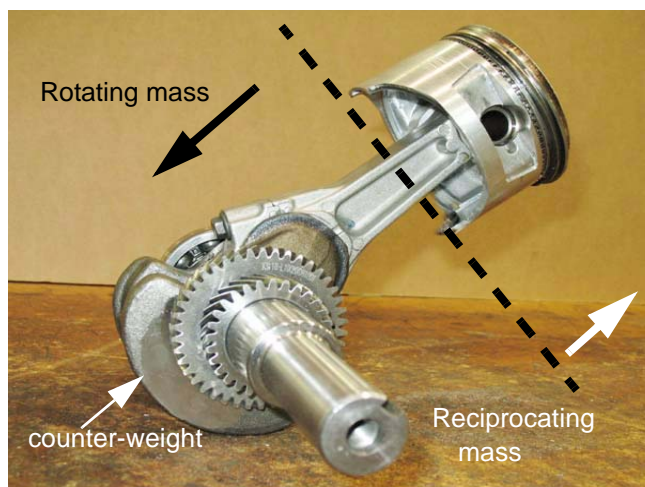

Figure 10.17

As an extra feature, the 483 and 490 series engines come with a balance shaft. The balance shaft further reduces side to side shaking forces by having an eccentric weight attached to it. The shaft is geared to the crankshaft and rotates at the same speed as the crankshaft, but in the opposite direction. The eccentric weight helps counter act the shaking forces as well as dynamically balances the crankshaft. See Figure 10.18.

NOTE: The timing of the balance shaft to the crankshaft will be covered in the Reassembly section of this chapter.

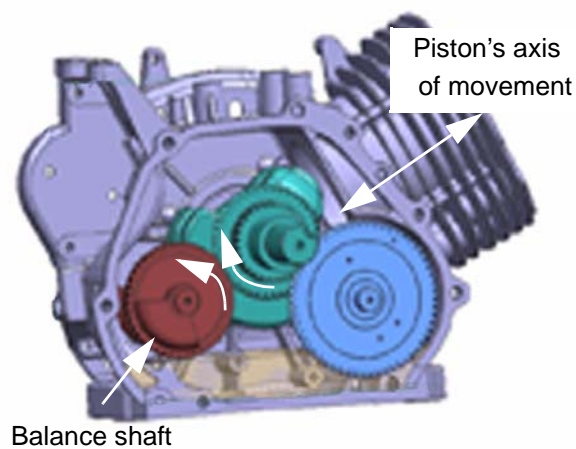

Figure 10.18

Crankshaft, piston and connecting rod

Reassembly

1. Install the governor shaft.

NOTE: The governor shaft **MUST** be installed before the crankshaft is installed.

2. Clean the cylinder

2a. Remove all gasket material from all mating surfaces.

2b. Clean the cylinder and crank case cover.

3. Oil seals

3a. Install a new oil seal in the cylinder block.

3b. Install a new seal in the crank case cover.

4. Insert the crankshaft and bearing into the cylinder block.

NOTE: Pre-lube the crankshaft with clean 10W-30 motor oil.

NOTE: Use an old piece of microfiche or a seal protector to protect the oil seal lip while inserting the crank shaft.

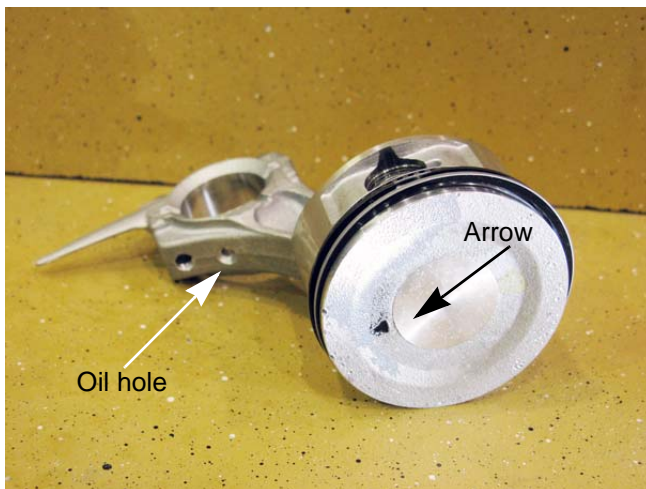

Figure 10.19

5. Install the piston by:

NOTE: If the piston and connecting rod were separated, reconnect them so that the arrow on the piston head points to the oil hole in the connecting rod. See Figure 10.19.

5a. Compress the piston rings using a piston ring compressor.

5b. Pre-lube the cylinder wall with clean 10W-30 motor oil

5c. Slide the connecting rod and piston into the cylinder.



Figure 10.20

NOTE: The arrow on the piston must point towards the push rod cavity.

5d. Tap the piston through the ring compressor into the cylinder using a wooden hammer handle. See Figure 10.20.

NOTE: Make sure the crank pin is at BDC (bottom dead center) to prevent damage from the connecting rod.

5e. Pre-lube the connecting rod with clean 10W-30 motor oil

5f. Install the connecting rod cap. Tighten the cap bolts to a torque of 106 -124 in-lbs (12 - 14Nm).

78/83/90 Series Horizontal Shaft Engines

6. Install the balance shaft by:
 - 6a. Pre-lube the balance shaft with clean 10W-30 motor oil
 - 6b. Rotate the crankshaft until the timing mark on the larger gear points to the 7:30 position.
 - 6c. Insert the balance shaft while aligning the timing marks. See Figure 10.21.
7. Install the valve tappets.



Figure 10.21

8. Install the cam shaft by:
 - 8a. Pre-lube the cam shaft with clean 10W-30 motor oil
 - 8b. Rotate the crank shaft until the timing mark points to the tappets.
 - 8c. Insert the cam shaft while aligning the timing marks. See Figure 10.22.

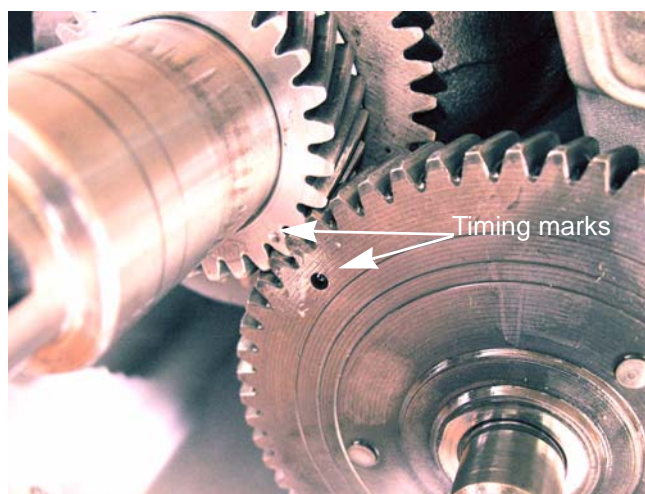

Figure 10.22

9. Place a new gasket on the crankcase cover, let the alignment dowels hold it in place.
10. Using a seal protector, slide the crankcase cover on to the crank shaft.
11. Gently rock the crank case cover while rotating the crankshaft until it seats fully against the cylinder block.
12. Install the crank case cover bolts and tighten to a torque of 80 - 106 in-lbs (9 - 12 Nm).
NOTE: Use a star torque pattern to tighten the cover bolts.
13. Install the cylinder head by following the steps described in Chapter 9: Cylinder head.
14. Install the muffler by following the steps described in Chapter 8: Exhaust.
15. Install the fuel tank by following the steps described in Chapter 4: Fuel systems and Governor.
16. Install the carburetor by following the steps described in Chapter 3: Air Intake and Filters.
17. Install the flywheel and module by following the steps described in Chapter 7: Ignition system.
18. Install the blower housing and starter by following the steps described in Chapter 6: Starter and Charging Systems.
19. Install the engine on the application by following the steps described in the application's service manual.
20. Install the spark plug by following the steps described in Chapter 7: Ignition system.
21. Fill the engine with oil and fuel by following the steps described in Chapter 1: Introduction.
22. Test run the engine in a safe area and make any carburetor and governor adjustments needed.

Crankshaft, piston and connecting rod**Engine specifications chart**

Specification	New Min		New Max		Service Limit	
	in.	mm	in.	mm	in.	mm
Bore (digit 2&3 of the model number)						
78	3.071	78.02	3.072	78.03	3.080	78.23
83	3.268	83.02	3.269	83.03	3.277	83.24
90	3.544	90.02	3.544	90.03	3.553	90.26
Crank pin min. diameter						
78	1.298	32.98	1.299	32.99	1.296	32.92
83	1.417	35.98	1.417	35.99	1.414	35.91
90	1.417	35.98	1.417	35.99	1.414	35.91
Piston pin min diameter						
78	0.713	18.10	0.716	18.20	0.711	18.07
83	0.795	20.19	0.795	20.20	0.793	20.15
90	0.795	20.19	0.795	20.20	0.793	20.15
Connecting rod max. ID (crank side)						
78	1.300	33.02	1.300	33.03	1.302	33.08
83	1.418	36.02	1.418	36.03	1.420	36.08
90	1.418	36.02	1.418	36.03	1.420	36.08
Connecting rod max. ID (piston side)						
78	0.717	18.22	0.718	18.23	0.719	18.25
83	0.796	20.22	0.796	20.23	0.797	20.26
90	0.796	20.22	0.796	20.23	0.797	20.26
Connecting rod to crank pin max. running clearance						
78	0.001	0.03	0.002	0.05	0.003	0.07
83	0.001	0.03	0.002	0.05	0.003	0.07
90	0.001	0.03	0.002	0.05	0.003	0.07
Connecting rod to crank pin max. side clearance						
78	0.006	0.15	0.026	0.65	0.049	1.24
83	0.006	0.15	0.026	0.65	0.049	1.24
90	0.006	0.15	0.026	0.65	0.049	1.24
Crank shaft run out (max)						
78	0.001	0.03	0.001	0.03	0.001	0.03
83	0.001	0.03	0.001	0.03	0.001	0.03
90	0.001	0.03	0.001	0.03	0.001	0.03
Crank shaft end play (max)						
78	0.016	0.40	0.035	0.88	0.035	0.88
83	0.000	0.00	0.022	0.55	0.022	0.55
90	0.000	0.00	0.022	0.55	0.022	0.55

78/83/90 Series Horizontal Shaft Engines

Specification	New Min		New Max		Service Limit	
	in.	mm	in.	mm	in.	mm
Intake lobe height						
78	1.248	31.70	1.252	31.80	1.237	31.42
83	1.281	32.54	1.285	32.64	1.269	32.24
90	1.281	32.54	1.285	32.64	1.269	32.24
Exhaust lobe height						
78	1.248	31.70	1.252	31.80	1.237	31.52
83	1.261	32.02	1.264	32.12	1.249	31.73
90	1.261	32.02	1.264	32.12	1.249	31.73
Cam shaft min OD (cylinder block side)						
78	0.636	16.17	0.637	16.18	0.633	16.09
83	0.636	16.17	0.637	16.18	0.633	16.09
90	0.636	16.17	0.637	16.18	0.633	16.09
Cam shaft min OD (sump side)						
78	0.636	16.17	0.637	16.18	0.633	16.09
83	0.636	16.17	0.637	16.18	0.633	16.09
90	0.636	16.17	0.637	16.18	0.633	16.09
Cam shaft bearing max. ID (cylinder block)						
78	0.638	16.20	0.639	16.22	0.639	16.22
83	0.638	16.20	0.639	16.22	0.639	16.22
90	0.638	16.20	0.639	16.22	0.639	16.22
Cam shaft bearing max. ID (sump)						
78	0.638	16.20	0.639	16.22	0.639	16.22
83	0.638	16.20	0.639	16.22	0.639	16.22
90	0.638	16.20	0.639	16.22	0.639	16.22
Balance shaft min OD (cylinder block side)						
78	N/A	N/A	N/A	N/A	N/A	N/A
83	0.589	14.97	0.590	14.98	0.587	14.90
90	0.589	14.97	0.590	14.98	0.587	14.90
Balance shaft min OD (sump side)						
78	N/A	N/A	N/A	N/A	N/A	N/A
83	0.589	14.97	0.590	14.98	0.587	14.90
90	0.589	14.97	0.590	14.98	0.587	14.90
Balance shaft bearing max. ID (sump)						
78	N/A	N/A	N/A	N/A	N/A	N/A
83	0.591	15.00	0.591	15.00	0.592	15.03
90	0.591	15.00	0.591	15.00	0.592	15.03

Crankshaft, piston and connecting rod

Specification	New Min		New Max		Service Limit	
	in.	mm	in.	mm	in.	mm
Balance shaft bearing max. ID (cylinder block)						
78	N/A	N/A	N/A	N/A	N/A	N/A
83	0.591	15.00	0.591	15.00	0.592	15.03
90	0.591	15.00	0.591	15.00	0.592	15.03
Compression ring to land max. clearance						
78	0.001	0.02	0.002	0.06	0.008	0.20
83	0.001	0.02	0.002	0.06	0.008	0.20
90	0.001	0.02	0.002	0.06	0.008	0.20
Scrapper ring to land max. clearance						
78	0.001	0.02	0.002	0.06	0.008	0.20
83	0.001	0.02	0.002	0.06	0.008	0.20
90	0.001	0.02	0.002	0.06	0.008	0.20
Compression ring end gap						
78	0.008	0.20	0.016	0.40	0.039	0.20
83	0.008	0.20	0.016	0.40	0.039	0.20
90	0.008	0.20	0.016	0.40	0.039	0.20
Scraper ring end gap						
78	0.008	0.20	0.016	0.40	0.039	0.20
83	0.008	0.20	0.016	0.40	0.039	0.20
90	0.008	0.20	0.016	0.40	0.039	0.20

78/83/90 Series Horizontal Shaft Engines

	Minimum		Maximum	
	in.	mm	in.	mm
Intake valve lash				
78	0.004	0.10	0.006	0.15
83	0.004	0.10	0.006	0.15
90	0.004	0.10	0.006	0.15
Exhaust valve lash				
78	0.006	0.15	0.008	0.20
83	0.006	0.15	0.008	0.20
90	0.006	0.15	0.008	0.20
Spark plug gap				
78	0.026	0.65	0.030	0.75
83	0.026	0.65	0.030	0.75
90	0.026	0.65	0.030	0.75
Module air gap				
78	0.016	0.40	0.024	0.60
83	0.016	0.40	0.024	0.60
90	0.016	0.40	0.024	0.60
Displacement				
78	16.9 cid (277 cc)			
83	21.8 cid (357 cc)			
90	25.6 cid (420 cc)			
Governed engine RPM				
78	3500 ± 100			
83	3500 ± 100			
90	3500 ± 100			
Oil capacity				
78	37 oz	1.1 L		
83	37 oz	1.1 L		
90	37 oz	1.1 L		
Fuel tank capacity				
78	1.3 gal	5.0 L		
83	1.3 gal	5.0 L		
90	1.3 gal	5.0 L		

Crankshaft, piston and connecting rod**Engine torque values chart**

Fastener Torque	78	83	90
Blower housing	80-106 in-lbs (9-12 Nm)	80-106 in-lbs (9-12 Nm)	80-106 in-lbs (9-12 Nm)
Carburetor drain bolt	80-106 in-lbs (9-12 Nm)	80-106 in-lbs (9-12 Nm)	80-106 in-lbs (9-12 Nm)
Carburetor mounting nuts	80-106 in-lbs (9-12 Nm)	80-106 in-lbs (9-12 Nm)	80-106 in-lbs (9-12 Nm)
Connecting rod cap bolts	106-124 in-lbs. (12-14Nm)	106-124 in-lbs. (12-14Nm)	106-124 in-lbs. (12-14Nm)
Crank case cover bolts	195-221 in-lbs (22-25 Nm)	195-221 in-lbs (22-25 Nm)	195-221 in-lbs (22-25 Nm)
Drain plug	106 -124 in-lbs.(12-14Nm)	106 -124 in-lbs.(12-14Nm)	106 -124 in-lbs.(12-14Nm)
Flywheel nut	66-81 ft-lbs (90-110Nm)	66-81 ft-lbs (90-110Nm)	66-81 ft-lbs (90-110Nm)
Head bolt	38-41 ft-lbs step (52-55 Nm)	38-41 ft-lbs step (52-55 Nm)	38-41 ft-lbs step (52-55 Nm)
Module	80-106 in-lbs (9-12 Nm)	80-106 in-lbs (9-12 Nm)	80-106 in-lbs (9-12 Nm)
Muffler	159-195 in-lbs (18-22Nm)	159-195 in-lbs (18-22Nm)	159-195 in-lbs (18-22Nm)
Rocker jam nut	80-106 in-lbs (9-12 Nm)	80-106 in-lbs (9-12 Nm)	80-106 in-lbs (9-12 Nm)
Rocker stud	16-18 ft-lbs step (22-25 Nm)	16-18 ft-lbs step (22-25 Nm)	16-18 ft-lbs step (22-25 Nm)
Spark plug	15-18 ft-lbs (20-25 Nm)	15-18 ft-lbs (20-25 Nm)	15-18 ft-lbs (20-25 Nm)
Starter (recoil)	53-71 in-lbs (6-8 Nm)	53-71 in-lbs (6-8 Nm)	53-71 in-lbs (6-8 Nm)
Starter (electric)	15-18 ft-lbs (20-25 Nm)	15-18 ft-lbs (20-25 Nm)	15-18 ft-lbs (20-25 Nm)
Valve cover	62-80 in-lbs (7-9 Nm)	62-80 in-lbs (7-9 Nm)	62-80 in-lbs (7-9 Nm)

For Parts Call 606-678-9623 or 606-561-4983

78/83/90 Series Horizontal Shaft Engines

CHAPTER 11: FAILURE ANALYSIS

A properly maintained engine will provide years of service. Occasionally an engine will fail. An important part of working on engines is finding out why they failed. Was it something the customer did? Was it a manufacturing defect? Did the engine just wear out? All of these questions need to be answered when a failed engine is found.

Engines can fail in a variety of ways but most failures can be classified in the following categories:

- Abrasive ingestion
- Insufficient lubrication
- Over heating
- Over speed
- Mechanical breakage/ wear

NOTE: There may be a combination of failures.

Finding the cause of an engine failure requires the complete disassembly of an engine and careful examination of the parts. With a good understanding of how the engine works, close examination of the parts and experience, an understanding of why the engine failed can be reached.

Abrasive Ingestion

Abrasive Ingestion is when hard particles are introduced into the engine. Particles can be introduced into the engine by leaks in the air intake system, through a dirty oil fill plug or by particles of metal that wore off of a part, especially during the break in cycle. Particles may also be introduced through worn or improperly installed seals or gaskets.

Some of the engines in this series are designed to be used on snow blowers so they are not equipped with an air filter. When used for snow blowing there is very little risk of dirt ingestion from the intake air because there is no dust in the air when it is snowing.

NOTE: Abrasive ingestion from the intake system generally is from using the equipment in a way that it was not designed for such as blowing hay or cleaning chicken coops. These failures are not covered under warranty.



Figure 11.1

1. Abrasive particles that enter the engine through the intake system can be sand, hay or dirt. See Figure 11.1.
2. An abrasive particle that enter the engine usually leave tracking marks were the particles enter the system. Use these marks to find the source of the abrasives.
3. Particles that enter the intake system travel at great speed and act like sand blasting media inside the engine. This causes wear to the parts affected.
4. The particles can pass through the intake system to the valves and valve seats.

78/83/90 Series Horizontal Shaft Engines

5. When particles enter the combustion chamber, the up and down motion of the piston grinds the particles into the side of the cylinder walls and damages the cylinder wall, piston and piston rings
6. This can be identified by the scoring along the vertical axis of the piston and cylinder wall or the cross hatch on the cylinder wall being worn off.

NOTE: To help in the lubrication of the cylinder walls, and help with the seating of the piston rings, a diamond cross hatch is honed into the cylinder wall. Debris entering the cylinder will polish the cross hatch off of the cylinder wall. See Figure 11.2.

NOTE: Abrasives that enter the engine through the intake system will cause the upper portion of the combustion chamber to wear more than the lower portion. Measurements of the cylinder bore at the top and bottom will show this.

Other sources of abrasives that get into the engine includes carbon that builds up on the top side of the piston, metal shavings from the wear of engine parts or dirt entering through the oil fill port. Leaking gaskets and seals also have the potential of allowing debris to enter the engine.

A symptom of abrasive ingestion is smoky exhaust. As the cylinder walls wear, pressure from the combustion chamber blows by the piston and pressurizes the engine sump. This overpowers the PCV valve and allows oil to build up in the combustion chamber. See Figure 11.3.

7. Abrasive materials that enter the engine get absorbed by the oil and thickens it. See Figure 11.4.



Figure 11.2



Figure 11.3



Figure 11.4

Failure Analysis



Figure 11.5

8. Because the oil suspends the abrasive particles, the engine components that are immersed in oil will show definite signs of abrasive ingestion especially around the connecting rod and main bearing journals. See Figure 11.5.

NOTE: Abrasives that are trapped in the oil will cause the lower portion of the combustion chamber to wear more than the upper portion.

NOTE: Wear of only one bearing surface on a new engine could be a sign of a manufacturing defect.

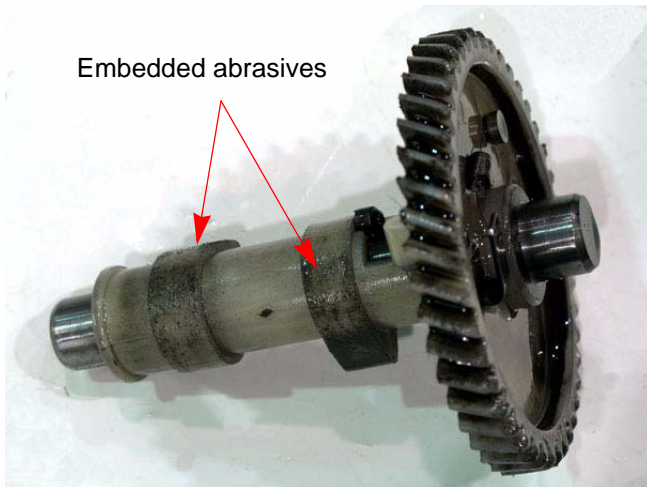

Figure 11.6

NOTE: Abrasive particles can also be embedded into materials that are softer than the abrasive. This will cause the affected part to act like a piece of sand paper or a grinding wheel. See Figure 11.6.

78/83/90 Series Horizontal Shaft Engines

Insufficient lubrication

The bearing surfaces in an engine are not smooth. As a result of the machining processes to make the engine parts, there are little peaks and valleys that are only visible on a microscopic scale. These peaks are called asperities. As the engine breaks in, the asperities break off leaving plateaus that become the bearing surface. The valleys become reservoirs for the lubricant.

When an engine is properly lubricated, all of the moving parts glide on a thin film of oil. If that film breaks down or carries enough grit to bridge the film, damage will occur.

1. When the parts are at rest, they push the lubricant or oil away resting on the bearing surfaces. As the parts rotate, they climb over the oil, pulling the oil between the bearing and the part, riding on a film of oil.

The asperities are the first thing to make contact between two moving engine parts with an insufficient oil film between them. This creates friction and causes a transfer of metal between the parts. The heat and friction further breaks down the oil film, accelerating the process.

2. Insufficient lubrication failures include:

- Low oil level
- Wrong oil for the application
- Contaminated oil
- Degraded oil (heat, age, acids)

3. Metal transfer is the primary indicator that the film of oil between two engine parts has been violated.

If the damage is localized, a general failure of the lubrication system is probably not the cause.

As an example: a piston skirt shows metal transfer to the cylinder wall. The connecting rod and wristpin show some signs of excessive heat. The main bearings and camshaft are not damaged. This would indicate that the problem was probably related to cylinder temperature.

The hall mark of a lubrication failure is the presence of discoloration and/or metal transfer on all friction surfaces within the engine. See Figure 11.7.

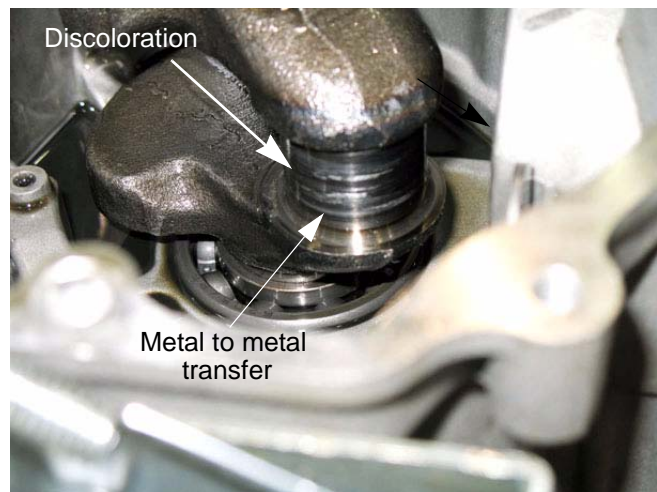

Figure 11.7

An important thing to note is that just because there are signs of insufficient lubrication, that does not mean that was the cause of the failure. It may only be a symptom of the real cause of the failure.

Larger size abrasive particles can render the lubricants ineffective, leading to an engine failure. An overheated engine can cause the oil to break down leading to a failure. In an engine overspeed, the oil is pushed away from the bearing surface leading to a failure.

In all three of the above cases, the signs of insufficient lubrication are symptoms not the cause. There will also be signs of heat or discoloration around the parts affected by the lack of lubrication. See Figure 11.8.

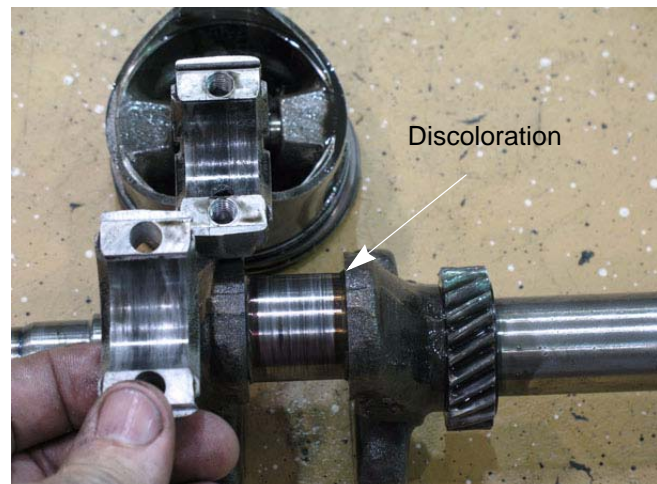

Figure 11.8

Engine Overspeed

The MTD engine is designed for a maximum speed of 3600 rpm. When the governor is unable to control the engine rpm, the engine can accelerate past the safe maximum speed.

When an engine runs beyond its designed speed, a few things happen:

1. As the piston moves up and down in the cylinder, it builds momentum. The higher the rpm's the more momentum produced by the pistons. As the momentum builds, the connecting rods will start to stretch. When the connecting rods stretch, they get weaker. Generally speaking this is at the narrowest part of the connecting rods. On most engines that would be about an inch below the wrist pin, but on the MTD engine it is at the wrist pin.

The force on the connecting rod is greatest when the piston transitions from the upward stroke to the downward stroke. Because of this, most overspeed connecting rod failures will occur with the piston at top dead center.

When a connecting rod fails, the piston stops moving but the crankshaft is still moving. This will allow the broken connecting rod to get knocked around in the cylinder causing more damage to it. Usually the connecting rod will be in several pieces after it breaks making it hard to find where the first failure was.
2. All engines have vibrations and are designed to handle those vibrations, but in overspeed the vibrations change resonance. Parts that can not handle the new resonance will crack. This may result in parts flying off of the engine which is an unsafe condition such as when a flywheel shatters pieces of it fly off of the engine.

The vibration can also lead to fasteners loosening up. Evidence of this could be elongated mounting holes. The area around the mounting holes may be polished due to the two surfaces rubbing against each other.
3. When an engine overspeeds, the moving parts can not pull the oil in between them. This allows metal to metal contact. Because of this, signs of inadequate lubrication will show.
4. When trying to diagnose an overspeed failure, look at all the pieces. Individually the lack of lubrication, piston position and condition of the connection rod will usually indicate separate failures. Collectively they would indicate an overspeed failure.

78/83/90 Series Horizontal Shaft Engines

Overheated

The MTD engines are air cooled engines. Because of this, cleanliness of the engine is very important to the life of the engine. Dirt, grass and sludge all form an insulating layer on the engine. This will trap the heat in the engine and cause it to over heat.

As metal parts heat up enough to change their properties, they will take on a yellowish or blue cast.

As oil is heated to the point that it evaporates, black deposits are left behind. This is called "coking". An engine with lots of coked oil deposits inside the crankcase or cylinder head indicates that it has been over heated. See Figure 11.9.

Another sign of an overheat failure is warped parts. As metal parts heat up, they expand. In an engine a certain amount of expansion is expected. Engines are built so that when parts are at operating temperature, the parts will expand to be within the tolerances needed for the engine to run. A problem occurs when the parts are over heated. They expand more than they were designed to. Some parts are mounted firmly, like cylinder heads (the hottest part of the engine). As they try to expand, they fight against the head bolts. The head bolts will not move to allow the expansion so the head warps to allow the expansion.

This warping of the head allows the head gasket to leak. A leaking head gasket allows the compressed gases in the engine to escape, lowering the compression in the engine and hurting engine performance. As the cylinder head cools, it shrinks back down to its normal size, but there will still be some warpage of the head. See Figure 11.10.

Localized over heating will leave localized "hot spot" indications, such as discoloration.

Rapid over heating of a cylinder, like when there is a cooling air flow obstruction, may cause hot spots and metal transfer between the piston skirt and the cylinder wall.

Over heating of the cylinder head may be caused by lack of air flow or exhaust system issues. Typical damage from this kind of over heating is a dropped valve seat. A dropped exhaust valve seat combined with coked oil in the cylinder head would be sure indicators of an over heated engine.

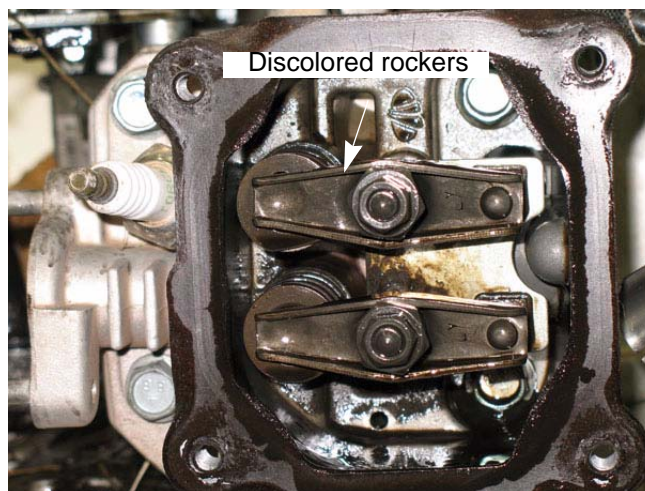
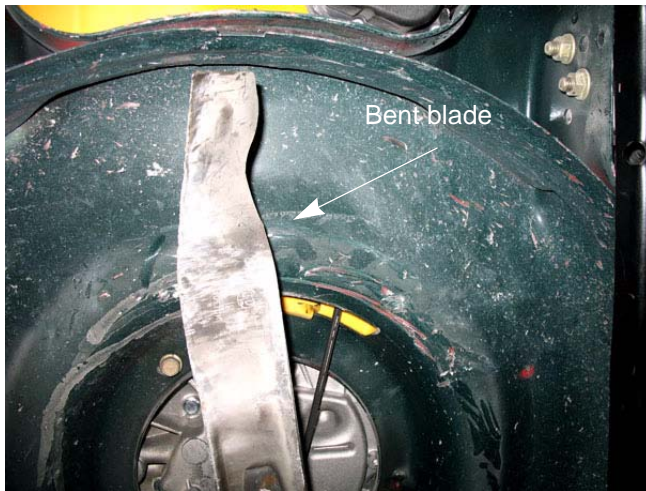

Figure 11.9



Figure 11.10

Mechanical Breakage/ Wear**Figure 11.11**

Sometimes an engine fails because a part breaks. There are generally three causes of a broken part, outside of the previously discussed engine failures. They are abuse, wear, and manufacturing defects.

A very common way to abuse an engine is a bent crank shaft. Crank shafts bend when they, or something bolted to them hits something. A prime example of this is when a mower blade hits a rock. See Figure 11.11.

As the engine runs, there is friction between the moving parts. This friction wears down the parts. Lubrication slows the process, but wear can not be prevented. Over time the parts wear to the point they break or fail in some way. Car tires are a good example of wear. A tire will only last for so many miles before all the rubber is worn off and the tire goes flat. Bushings are another example, they are designed to wear so that the wear of other parts will be minimized.

Vibration issues have a “chicken and the egg” relationship to mechanical failures. Which came first? Bent crankshafts and imbalanced implements will cause vibration issues. However a vibration issue, such as a over speed or loose mounting bolts on the engine, can shake an engine to pieces. The technician must find the source of the vibration in order to properly diagnosis an engine.

Manufacturing defects are wrongly blamed for a lot of failed parts. A manufacturing defect is when a part is made wrong. It could be a porous casting, parts assembled wrong, the wrong parts used or so on. A manufacturing defect will generally show up within the first couple of hours of use.

Detonation/preignition

Detonation is the undesirable condition of the fuel spontaneously combusting the combustion chamber prior to the spark plug firing. In this state, the flame front from the detonation will start to travel through the combustion chamber and a second flame front, from the spark plug, will crash into it. The pressure differential caused by this will send shock waves through the engine. The shock wave cause a knocking or pinging noise. This is why detonation is sometimes called “knocking”, “spark knocking” or “pinging”. The shock wave will also try to push the piston down against the direction of rotation of the crankshaft.

The shock wave from detonation can cause piston failures (melting or breakage), piston skirt damage, connecting rod breakage and in extreme cases crankshaft failures.

A build up of carbon deposits in the combustion chamber will increase the compression ratio. This is a major factor for the development of detonation. It insulates the combustion chamber, allowing it to heat up above normal operating temperatures.

Preignition is similar to detonation, but on a smaller scale. Preignition is cause by a localized hot spot or a hot deposit in the cylinder. As the fuel/air mixture is drawn into the cylinder, it is ignited. This creates pressure that tries to push the piston down against the direction of rotation of the crankshaft. The sounds and damage created by this is the same as detonation.

For Parts Call 606-678-9623 or 606-561-4983

78/83/90 Series Horizontal Shaft Engines

For Parts Call 606-678-9623 or 606-561-4983

www.mymowerparts.com

For Parts Call 606-678-9623 or 606-561-4983

MTD Products Inc - Product Training and Education Department

FORM NUMBER - 769-04951A

10/2010

www.mymowerparts.com