

21A-154A966 TB154 Electric Garden Cultivator (2009)
General Assembly

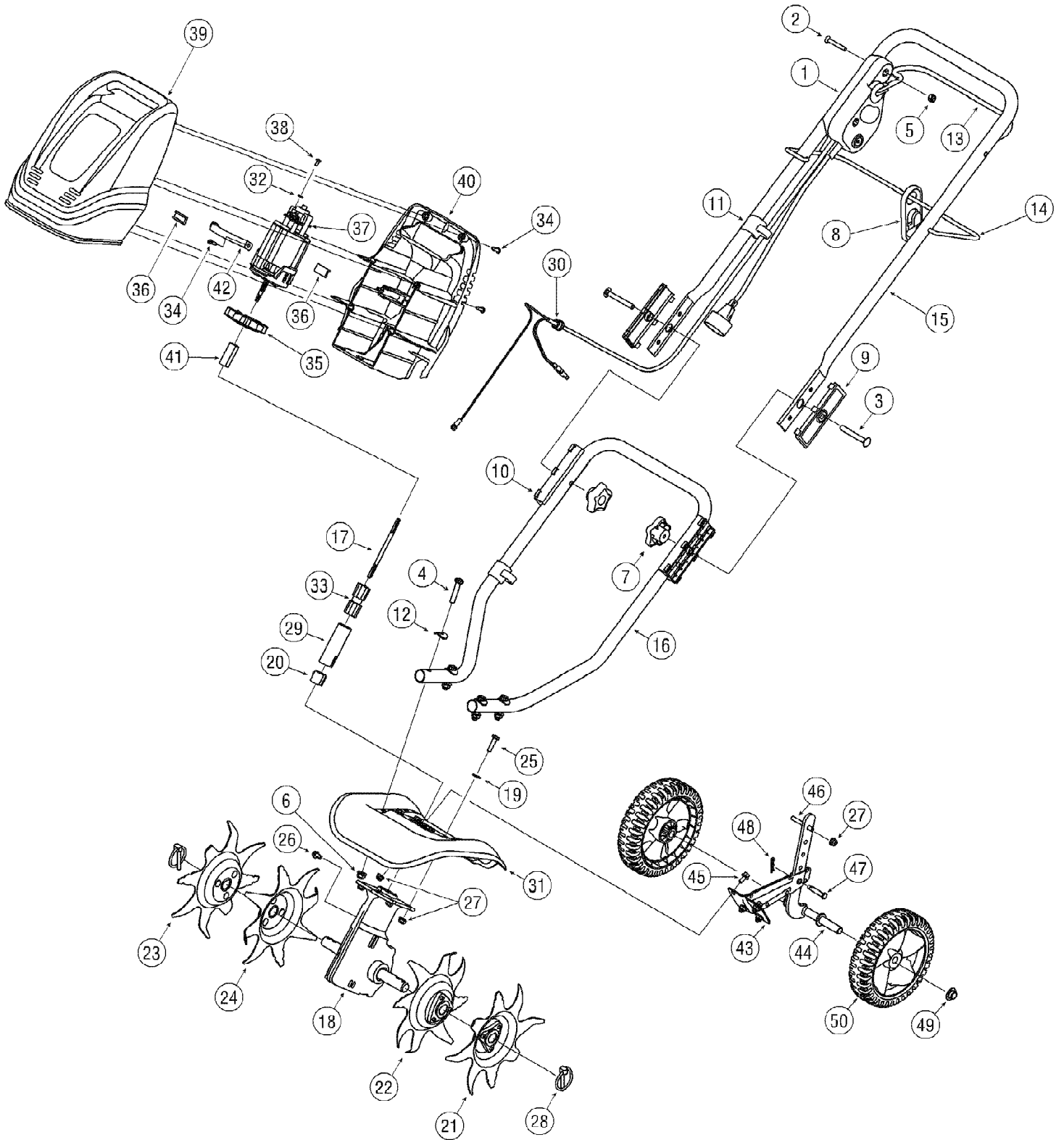

Ref #	Part Number	Qty	S/P/F	Description
1	625-04027	1	S	Switch Assembly
2	710-04213	1	S	Screw, T27,1/4-20, 1.75"
3	710-0572	1	/P	Bolt, Carriage, 5/16-18, 2.50, Gr1
4	710-0805	1	/P	Hex Screw, 5/16-18,1.50, Gr5
5	712-0324	1	/P	Nut, Hex Lock, 1/4-20, Gr8, Nylon
6	712-04063	1	/P	Nut, Flange Lock, 5/16-18, Gr8, Nylon
7	720-04052	1	S	Knob, Nut, 5/16-18
8	726-0368	1	S	Cord Retainer
9	731-05178	1		Insulator, Upper Handle
10	731-05186	1		Insulator, Lower Handle
11	731-1820	1	/P	Guide Cable
12	736-0451	1	S	Washer, Saddle, 320 x .93 x .060
13	747-04375	1	S	Control Bail
14	747-04376A	1	S	Guide Rod
15	749-04210	1		Handle, Upper
16	749-1295A	1	S	Handle, Lower
17	10055-20	1		Flex Shaft, 4.5"
18	11A6798	1	S	Gearbox
19	791-182678	1		Washer, Flat
20	791-181578	1		Sleeve
21	686-0176	1	S	Tine Assembly, Outer
22	686-0177	1	S	Tine Assembly, Inner
23	686-0178	1	S	Tine Assembly, Outer
24	686-0179	1	S	Tine Assembly, Inner
25	710-0597	1	/P	Hex Screw, 1/4-20, 1.00, Gr5
26	4543	1	S	Bolt, Hex Washer 1/4-20 x .50
27	712-04064	1	/P	Nut, Flange Lock, 1/4-20, GrF, Nylon
28	714-0220	1	S	Lynch Pin,.1875
29	750-04441	1	S	Tube,.922 x 1.0 x 3.0
30	731-04321	1	S	Bushing, Cord
31	786-04000	1	S	Tine Shield
32	1625	1		Washer, Lock, #10
33	1A2679	1		Tube w/ Spacers
34	1948	1	S	Screw,.750
35	50004	1	S	Fan
36	50545	1		Motor Pad, 1"
37	624-04008	1	S	Motor Assembly, 120V
38	1926	1	S	Screw, #8-32 x .312
39	731-05207	1		Motor Cover, Front
40	731-05208	1		Motor Cover, Rear
41	748-04085	1		Motor Hub
42	786-04268	1		Motor Strap
43	686-0181	1	S	Bracket Asembly, Tail Piece
44	686-0182A	1	S	Support Bracket Assembly, Wheel
45	710-04468	1		Hex Flange Screw, 1/4-20,.50,Gr5
46	711-0993	1	S	Belt Guard Pin 1/4 Dia. x 1.43
47	711-1017	1	/P	Clevis Pin, .250 x 1.53
48	714-0104	1	S	Cotter Pin,.072 Dia. x 1.13
49	726-0299	1	/P	Push Cap, 1/2"
50	734-1988	1	/P	Wheel, 7 x 1.8 Spoke Bar Gray