

13AN77KS066 Pony (2010)  
Drive & Transmission

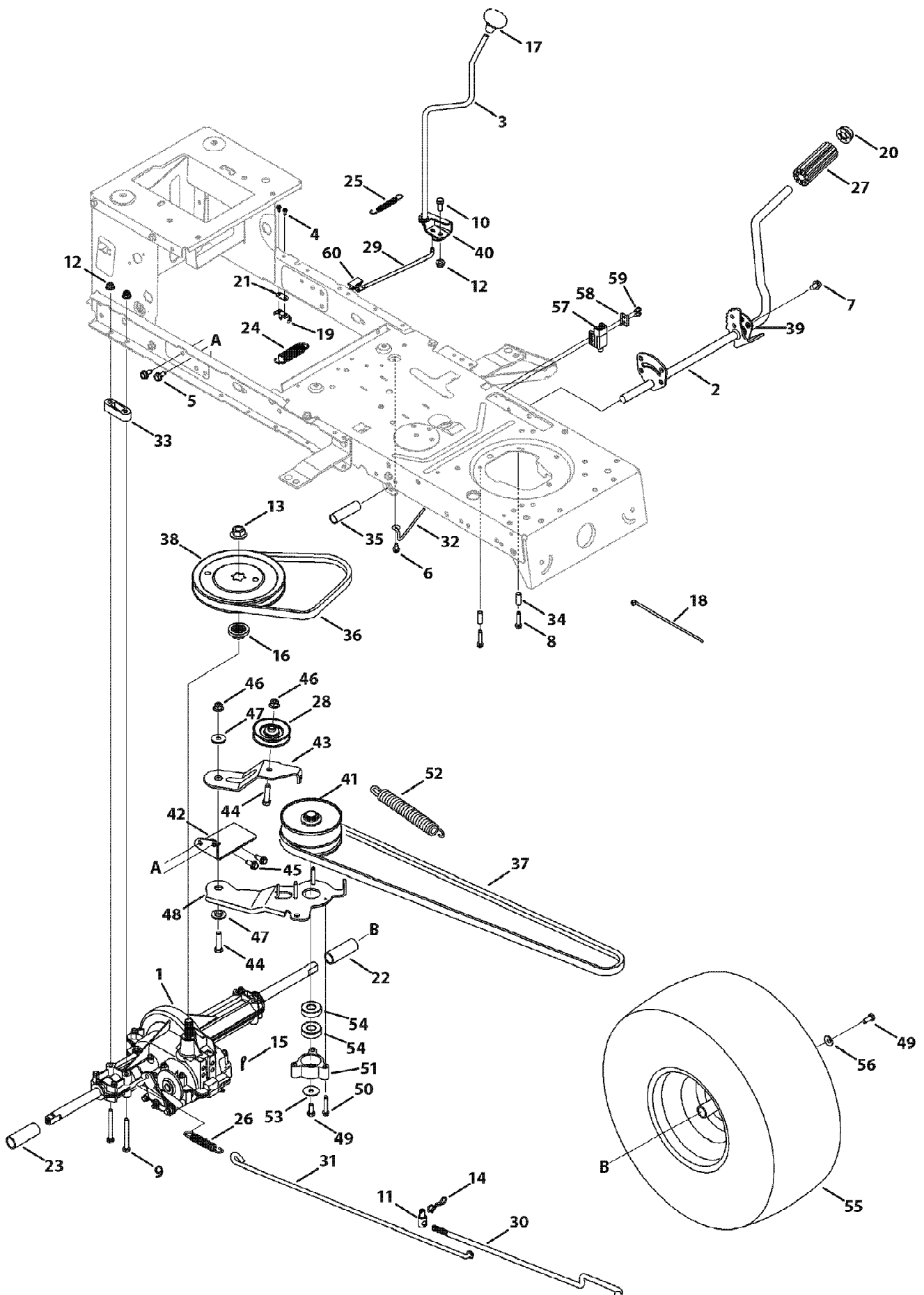

13AN77KS066 Pony (2010)  
Drive & Transmission

Page 2 of 21

Ref #	Part Number	Qty	S/P/F	Description
1	918-04566	1	/P	Transmission Drive Assembly
2	647-04034C-0638	1		Pedal Assembly - Red
3	647-04035	1		Shaft Lever Assembly
4	710-0227	1	/P	Screw, 8-18:0.500
5	710-04484	1		Screw, 5/16-18 x .750
6	710-0599	1	/P	Screw, 1/4-20 x 0.500
7	710-0604A	1	/P	Screw, 5/16-18 x 0.625
8	710-0809	1		Screw, 1/4-20 x 1.250
9	710-1266	1	/P	Hex Screw, 5/16-18 x .625
9	710-0176	1	/P	Hex Screw, 5/16-18 x 2.75
10	710-3008	1	/P	Hex Screw, 5/16-18 x .75
11	911-04075A	1	/P	Ferrule, 3/8-24 X .375 DIA.
12	712-04063	1	/P	Flangelock Nut, 5/16-18
13	712-0700	1	/P	Flange Nut, 9/16-18
14	914-0209	1	/P	Cotter Pin INT- .125 DIA
15	714-04040	1		Bow-Tie Cotter Pin, 72
16	718-04407	1		Pulley Hub, 5/8 SPLINE
17	720-04028	1		Shift Knob
18	725-0157	1	/P	Cable Tie
19	725-1644	1		Short Spring Switch
20	726-0214	1	/P	Push Cap, 5/8
21	926-0320	1	/P	Plate Insulator Nut
22	731-04602	1		Sleeve, .758 x .821 x 3.3125
23	731-04604	1		Sleeve, .758 x .821 x 2.4375
24	732-04306	1		Spring Extension, .80 OD x 3.28 LG
25	732-04488	1		Spring Extension, .38 OD x 3.25 LG
26	732-0716D	1	/P	Spring Extension, .59 OD x 4.00 LG
27	735-0239	1	/P	Foot Pad, 4.0 LONG
28	756-04325	1	/P	Idler Pulley
29	747-05244	1		Shift Rod, 38/42"
30	747-05186	1		Variable Speed Control Rod
31	747-04733A	1		Brake Rod
32	747-04969	1		Belt Keeper Rod
33	948-0334	1	/P	Spacer, T-Axle, 46" Only
34	750-0566A	1	/P	Spacer, .260 x .375 x 1.030 LG
35	750-0802	1		Spacer, .640 ID x .76 OD x 2.63
36	954-0241A	1	/P	V Belt, 5L 35.25 POLY
37	954-04249	1	/P	V Belt, 5L 70.90 POLY
38	956-04002	1	/P	V Pulley 7.25 DIA SPUN
39	783-04536B-0637	1	/P	Pedal Support Bracket
40	783-04595A	1		Shaft Adjust Bracket
41	956-04015A	1	/P	Variable Speed Pulley Assembly
42	683-04176A	1	/P	Transmission Bracket Assembly
43	683-04207	1		Idler Bracket Assembly
44	710-0347	1	/P	Hex Screw, 3/8-16 x 1.75
45	710-1260A	1	/P	Screw, 5/16-18 x 0.750
46	712-04065	1	/P	Flangelock Nut, 3/8-16
47	938-0347	1	/P	Shoulder Spacer, .625 ID x .169
48	683-04206	1		Bracket Assembly
49	710-0627	1	/P	Hex Screw, 5/16-24 x .750
50	710-0778	1	/P	Screw, 1/4-20 x 1.500
51	718-04261	1		Bearing Cup
52	732-0459C	1	/P	Extension Spring, .94 OD x 6.74 LG

13AN77KS066 Pony (2010)  
Drive & Transmission

Page 3 of 21

Ref #	Part Number	Qty	S/P/F	Description
53	736-0362	1	/P	Flat Washer, .330 x 1.25 x .06:HT
54	941-0600	1	/P	Ball Bearing, 17 x 40 x 12
55	634-0104-0911	1	/P	Wheel, 20 x 8 x 8, 38/42" Grey
55	734-1730-0901	1	/P	Tire Only 20 x 8 x 8 Not shown
55	634-04369-0662	1		Rim Only Not shown
55	934-0255	1	/P	Valve Stem Not shown
56	736-0242	1	/P	Bell Washer, .340 x .872 x .060
57	725-04363	1		Switch Interlock
58	17962	1		Plate Switch
59	738-04237A	1		Shoulder Screw, #10-32 x .500
60	731-06894	1		Shift Plate Bearing

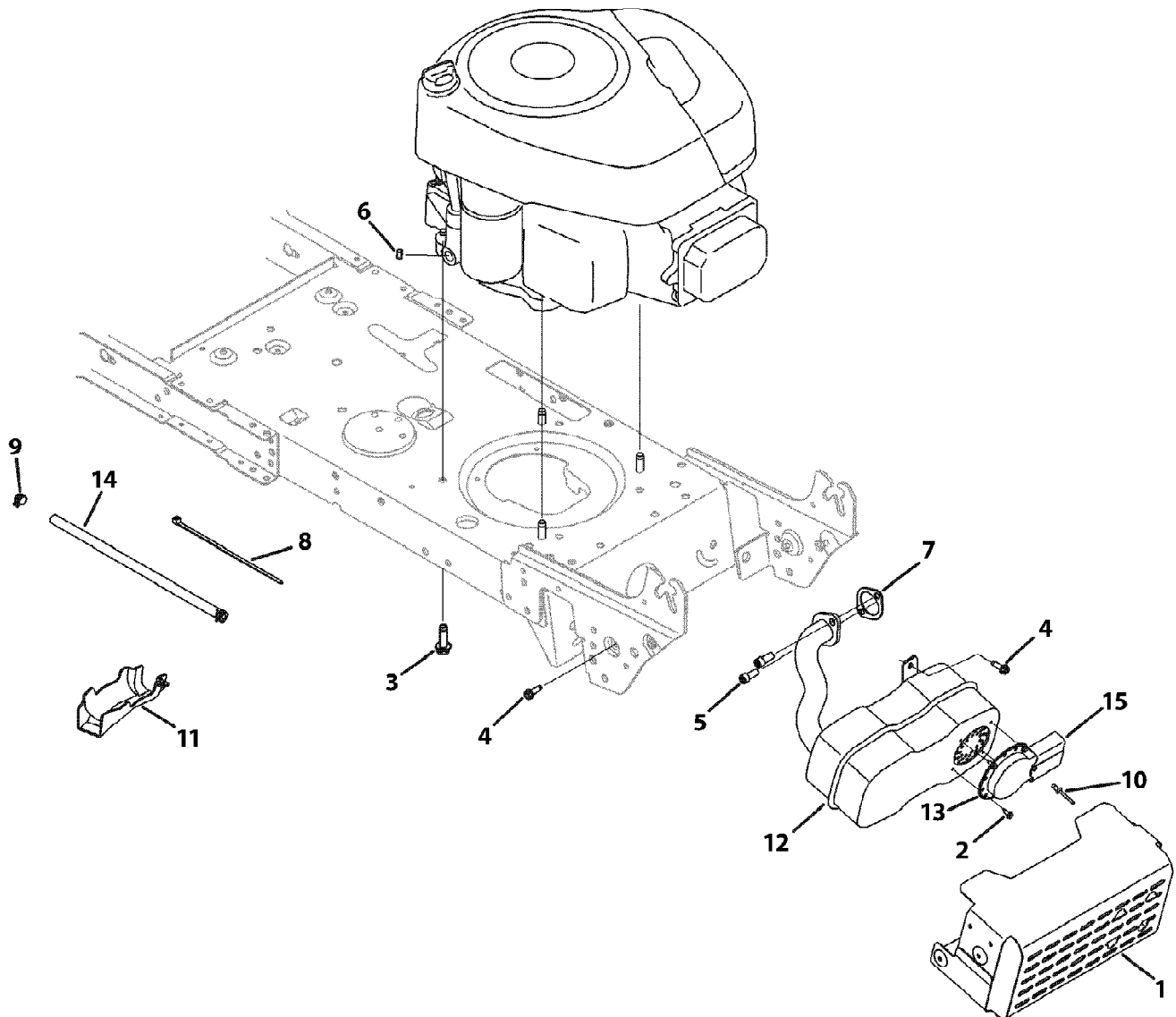

13AN77KS066 Pony (2010)  
Engine Accessories B&S

Page 5 of 21

Ref #	Part Number	Qty	S/P/F	Description
1	683-04549-0637	1	/P	Muffler Shield Assembly with Weld
2	710-0227	1	/P	Screw, 8-18 x .500
3	710-04683	1		Screw, 3/8-16 x 1.0
4	710-0642	1	/P	Screw, 1/4-20 x .750
5	710-1314A	1	/P	Socket Screw, 5/16-18 x .750
6	712-0271	1	/P	Sems Nut, 1/4-20
7	BS-692236	1	/P	Exhaust Gasket, 10 HP Briggs
8	725-0157	1	/P	Cable Tie
9	726-0205	1	/P	Clamp Hose, .490 diameter
10	728-04000	1		Rivet, .188 x .300
11	731-05628	1		Oil Drain Sleeve
12	751-10448A	1	S	Muffler, Single Inlet
13	751-0564B	1	/P	Muffler Deflector
14	751-10349-28	1	/P	Fuel Hose, Low Permeation
15	751-10353	1		Muffler Deflector Long

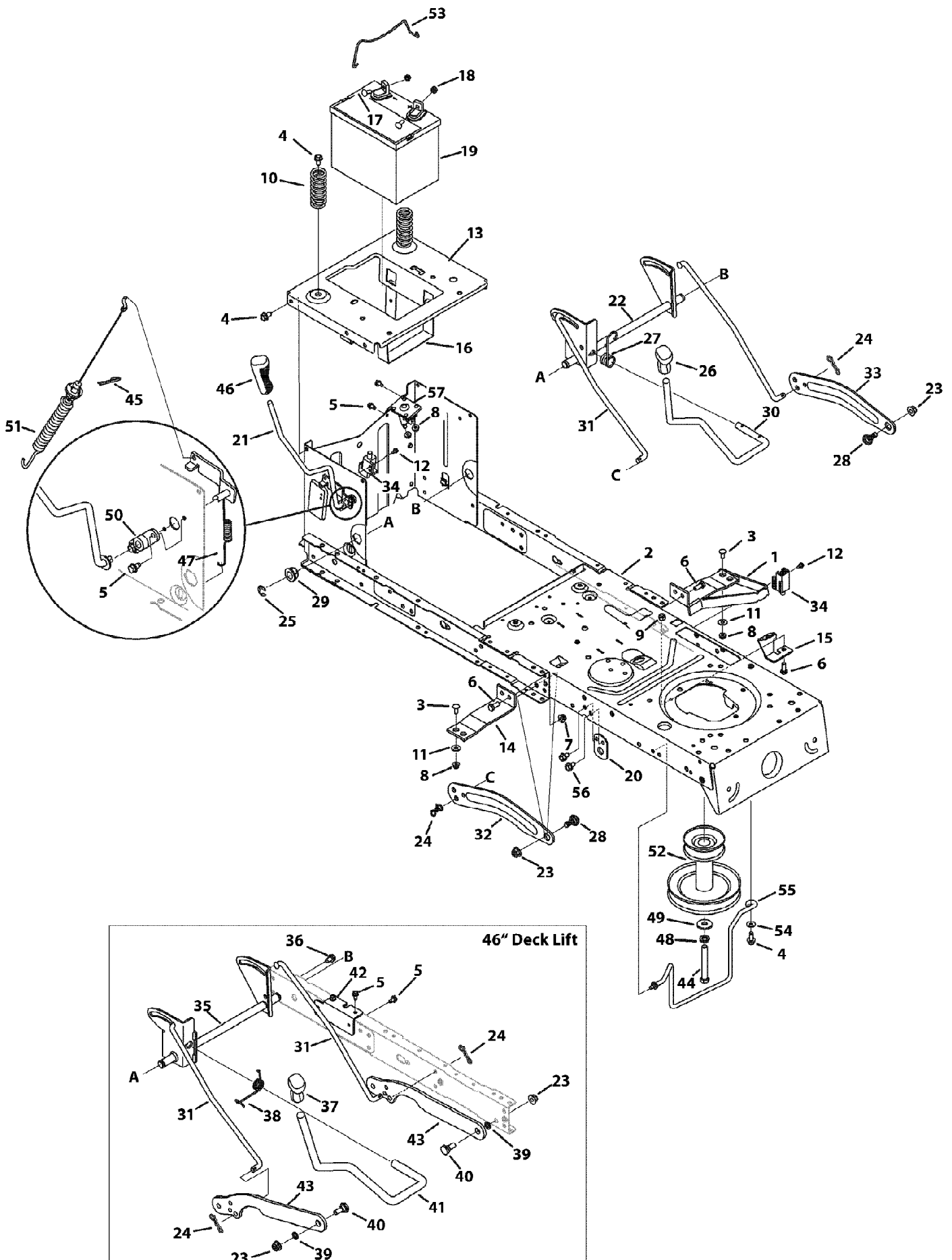

13AN77KS066 Pony (2010)  
Frame and PTO Lift

Page 7 of 21

Ref #	Part Number	Qty	S/P/F	Description
1	683-04195-0637	1		Support Bracket
2	683-04601-0638	1		Frame Assembly - Red
3	710-0134	1	/P	Screw Carriage, 1/4-20 x .62
4	710-04484	1		Screw 5/16-18 x .750
5	710-0599	1	/P	Screw, 1/4-20 x .500
6	710-3008	1	/P	Hex Screw, 5/16-18 x .75
7	712-04063	1	/P	Flangelock Nut, 5/16-18
8	712-04064	1	/P	Flangelock Nut, 1/4-20
9	912-0429	1	/P	Hexlock Nut, 5/16-18
10	732-04035	1		Compression Spacer, 1.28 x 3.125
11	736-0173	1	/P	Flat Washer, .28 x .74 x .063
12	738-04237A	1		Shoulder Spacer, 10-32 x .500
13	783-04548C-0637	1	/P	Seat Frame Bracket
14	783-04637-0637	1	/P	Running Board Bracket
15	783-04753-0637	1		Support Frame Bracket
16	783-04869A-0637	1	/P	Battery Bracket
17	710-04666	1		Hex Head Flange, 1/4-20 x .75
18	712-0271	1	/P	Sems Nut, 1/4-20
19	925-1707D	1	/P	230 CCA Battery
20	783-04536B-0637	1	/P	Support Bracket
21	647-04096-0637	1	/P	PTO Handle Assembly
22	683-04155A-0637	1	/P	Lift Assembly, 38/42"
23	712-04065	1	/P	Flangelock Nut, 3/8-16
24	714-04040	1		Bow-tie Cotter Pin
25	716-0106A	1		E Ring
26	720-0311	1		Handle Grip, 1/2
27	732-04225	1		Torsion Spring
28	738-04130	1		Shoulder Bolt, 3/8-16 x .625 x .175
29	941-0225	1	/P	Hex Flange Bearing
30	747-04282	1		Deck Lift Handle
31	747-04393	1		Lift Rod
32	783-04494C-0637	1	/P	38/42" Lift Arm, RH
33	783-04711C-0637	1	/P	38/42" Lift Arm, LH
34	725-04363	1		Switch Interlock
35	683-04334-0637	1	/P	Lift Assembly, 46"
36	710-0604A	1	/P	Screw, 5/16-18 x .625
37	720-0298	1		Handle Grip, 5/8
38	732-04438	1		Torsion Spring Handle, 46"
39	936-0140	1	/P	Flat Washer, .385 x .62 x .063
40	938-0380	1	/P	Shoulder Bolt, 3/8-16 x .500 x .270
41	747-04653	1		46" Lift Handle
42	783-05389A-0637	1	/P	Frame Brace Bracket
43	783-0678C-0637	1	/P	Lift Deck Link
44	710-04608	1		Hex Screw, 7/16-20 x 3.25, 38/42"
45	914-0145	1	/P	Click Pin, .092 x 1.64
46	720-04049A	1	/P	Handle Grip, 3/8
47	732-04276A	1	/P	PTO Spring Extension
48	936-0171	1	/P	Regular Duty Washer Lock, 7/16
49	736-0322	1	/P	Flat Washer, .450 x 1.250 x .164
50	741-04119A	1	/P	PTO Bearing
51	946-04173B	1	S	Deck Engage Cable
52	756-04196A	1	/P	Engine Pulley, 3.39 x 6.12, 38/42"
53	683-04448-0637	1	/P	Battery Hold Down Rod

13AN77KS066 Pony (2010)  
Frame and PTO Lift

Page 8 of 21

Ref #	Part Number	Qty	S/P/F	Description
54	936-0300	1	/P	Flat Washer, .406 x .875 x .059
55	747-04332A	1	/P	38" Belt Keeper
55	747-04857	1	/P	42" Belt Keeper
56	710-0604A	1	/P	Screw, 5/16-18.0 x .625
57	725-04439	1		12V Solenoid



13AN77KS066 Pony (2010)  
Hood & Dash Assembly

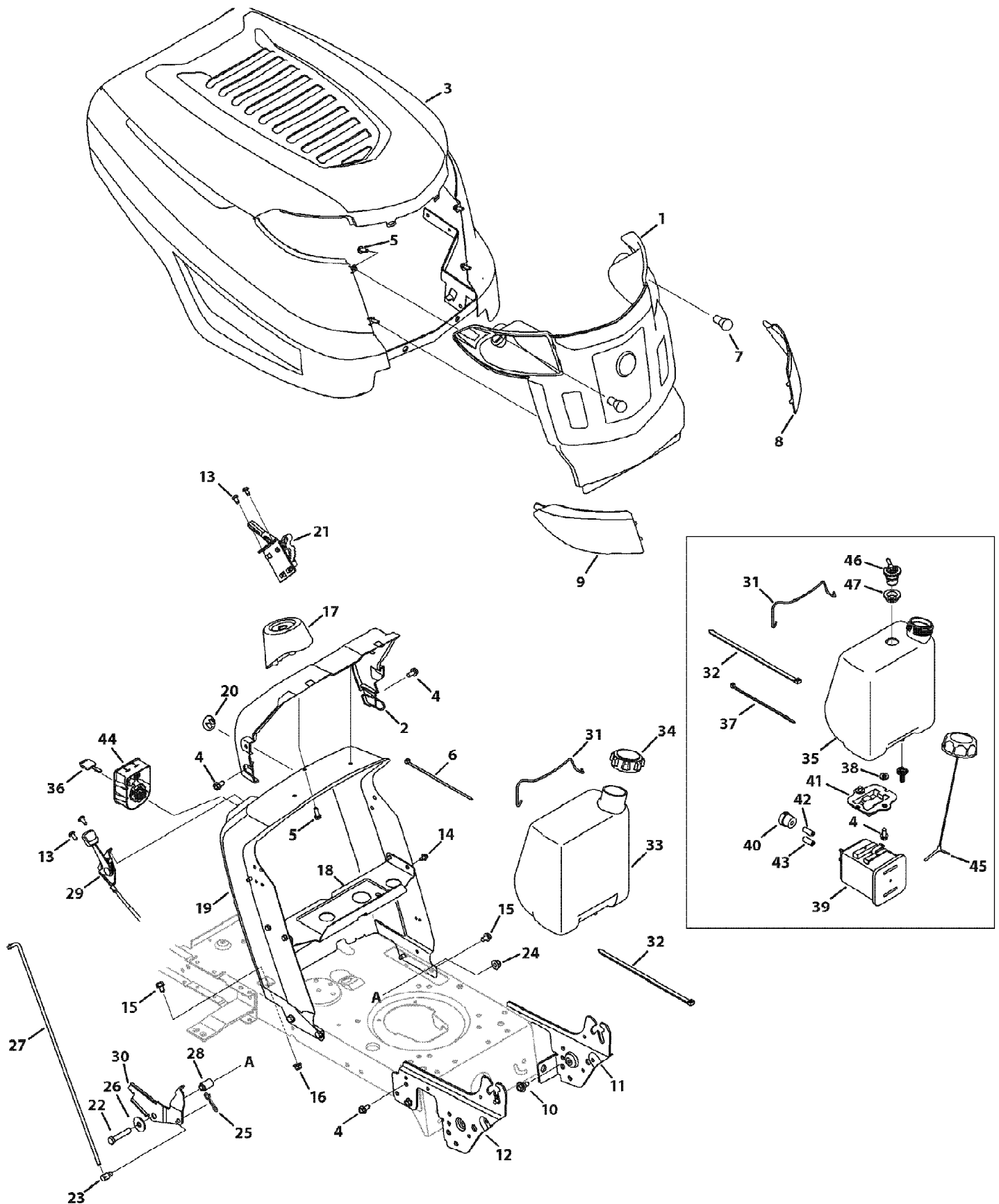

13AN77KS066 Pony (2010)  
Hood & Dash Assembly

Page 10 of 21

Ref #	Part Number	Qty	S/P/F	Description
1	631-04272	1	/P	Grill Assembly, Troy-Bilt
1	931-06796	1	/P	Grill Assembly, K-Style
2	731-05078C	1	/P	Dash Collar
2	731-06404	1		K-Style Bumper
2	710-04261	1		Screw, #12-16 x .50
3	683-04441-0638	1		Hood Assembly
4	710-04484	1		Screw, 5/16-18 x .750
5	710-0895	1		Screw, 1/4-15 x .750
6	725-0157	1	/P	Cable Tie
7	925-0963	1	/P	Lamp
8	731-06095	1		Left Lens
9	731-06096	1		Right Lens
10	738-04091A	1	/P	Shoulder Screw, 5/16-18 x .43 x .29
11	783-05327B-0637	1	/P	Left Support Pivot Bracket
12	783-05328A-0637	1	/P	Right Support Pivot Bracket
13	710-04483	1		Screw, 1/4-20 x .500
14	710-0599	1	/P	Hex Washer Screw, 1/4-20 x .500
15	710-0604A	1	/P	Screw, 5/16-18 x .625
16	712-04063	1	/P	Flangelock Nut, 5/16-18
17	731-04945	1		Steering Support
18	783-04584A-0637	1	/P	Gas Tank Support Bracket
19	783-04873B-0638	1	/P	Dash, No RMC - Red
20	731-05265	1		Choke Plug
21	983-04216	1	/P	7-Speed Control Assembly
22	710-3144	1	/P	Hex Screw, 3/8-16 x 2.0
23	711-0736	1	/P	Ferrule, 1/4-20 x 1.00
24	710-04065	1	/P	Flangelock Nut, 3/8-16
25	714-04040	1		Bow Tie Cotter Pin, 72
26	936-0133	1	/P	Flat Washer, .411 x 1.25 x .100
27	747-04430	1		Speed Selector
28	750-04465	1		Flange Spacer, .390 x .671 x 1.095
29	746-04364	1		Throttle/Choke Cable
30	783-04903	1		Speed Latch - No RMC
31	683-04448-0637	1	/P	Battery Assembly Rod
32	726-0230	1	/P	Cable Tie
33	751-0555B	1	/P	1.5 Gallon Fuel Tank
34	751-0603A	1	/P	Fuel Cap
35	751-10782	1	S	1.36 Gallon Fuel Tank
36	925-1745A	1	/P	Key
37	725-0157	1	/P	Cable Tie
38	936-3008	1	/P	Flat Washer, .344 x .750 x .120
39	951-10589	1	/P	5 Gallon Carbon Canister
40	951-10590	1	/P	Vent Filter Canister
41	951-10610	1	/P	Canister Adapter Bracket
42	751-10749-30	1		Fuel Hose, White
43	751-10750-28	1		Fuel Hose, Yellow
44	925-04659	1	/P	3 Position Key Switch
45	951-10947	1	/P	Fuel Cap, 2.25"
46	751-10441	1		Rollover Valve
47	735-04081	1		Rubber Grommet, 23 x 3.55

777X44277  
Place Under Hood

Model	Part No.	Part Name	Part No.
13AN77KS066	777X44277	Label	777X44277

Drivers RIGHT (777X43039) Drivers LEFT (777X43038)

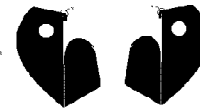

777I22453  
Place On Fender With The Pto Side Next To The Pto And The Deck Height Next To The Deck Height



If BJ label Has Important Emmissions Information



777D12014 x 2  
Align to top side of hood on both sides - center over intake



777D12110 x 2  
Center under the intake

7 SPEED TRANSMISSION

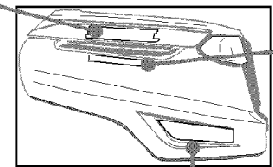

777D13164  
Align to LOWER Side Panel



777D13165  
Align to LOWER Side Panel



777D12005  
Center REAR fender



777D12223



Ref. - 777D13024



777I23092



777S30503



777S30018



777S33329

Reference Only



777I22455

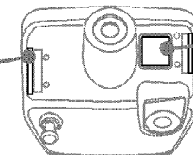

777I22479



13AN77KS066 Pony (2010)  
Label Map Pony

Page 12 of 21

Ref #	Part Number	Qty	S/P/F	Description
777X44277	777X44277	1		LABEL-RDR:PARTS:13WN/13AN77KS
777I22453	777I22453	1		LABEL-RIDER LT-5 F
777D12005	777D12005	1		LABEL-RIDER REAR FENDER TROY
777D12223	777D12223	1		LABEL-RIDER DECK RED TROY 42"
777S30018	777S30018	1	/P	LABEL-DECK SAFETY
777I23092	777I23092	1		LABEL-BELT ROUTING 46 OFFSET
777S30503	777S30503	1	/P	LABEL-DANGER CHUTE
777S33329	N/A	1		LABEL-RDRCHT:DNGCUT:42CMMN Mold In Graphic
777D13024	777D13024	1		LABEL-TROYBILT/GEAR
777I22455	777I22455	1		LABEL-RIDER LT-5 D
777I22479	777I22479	1		LABEL- RIDER LT-5
777D13165	777D13165	1		LABEL-RIDER LOWER LH PONY
777D13164	777D13164	1		LABEL-RIDER LOWER RH PONY
777D12110	777D12110	1		LABEL-RIDER K STYLE HOOD 7SPD TRAN
777D12014	777D12014	1		LABEL-RIDER HOOD K STYLE TROY
777X43038	777X43038	1		LABEL-RIDER K STYLE LH
777X43039	777X43039	1		LABEL-RIDER K STYLE RH
777S33017	777S33017	1		LABEL-LT 5 TRANS COVER NO OCR
777I22454	777I22454	1		LABEL-RIDER LT-5 F

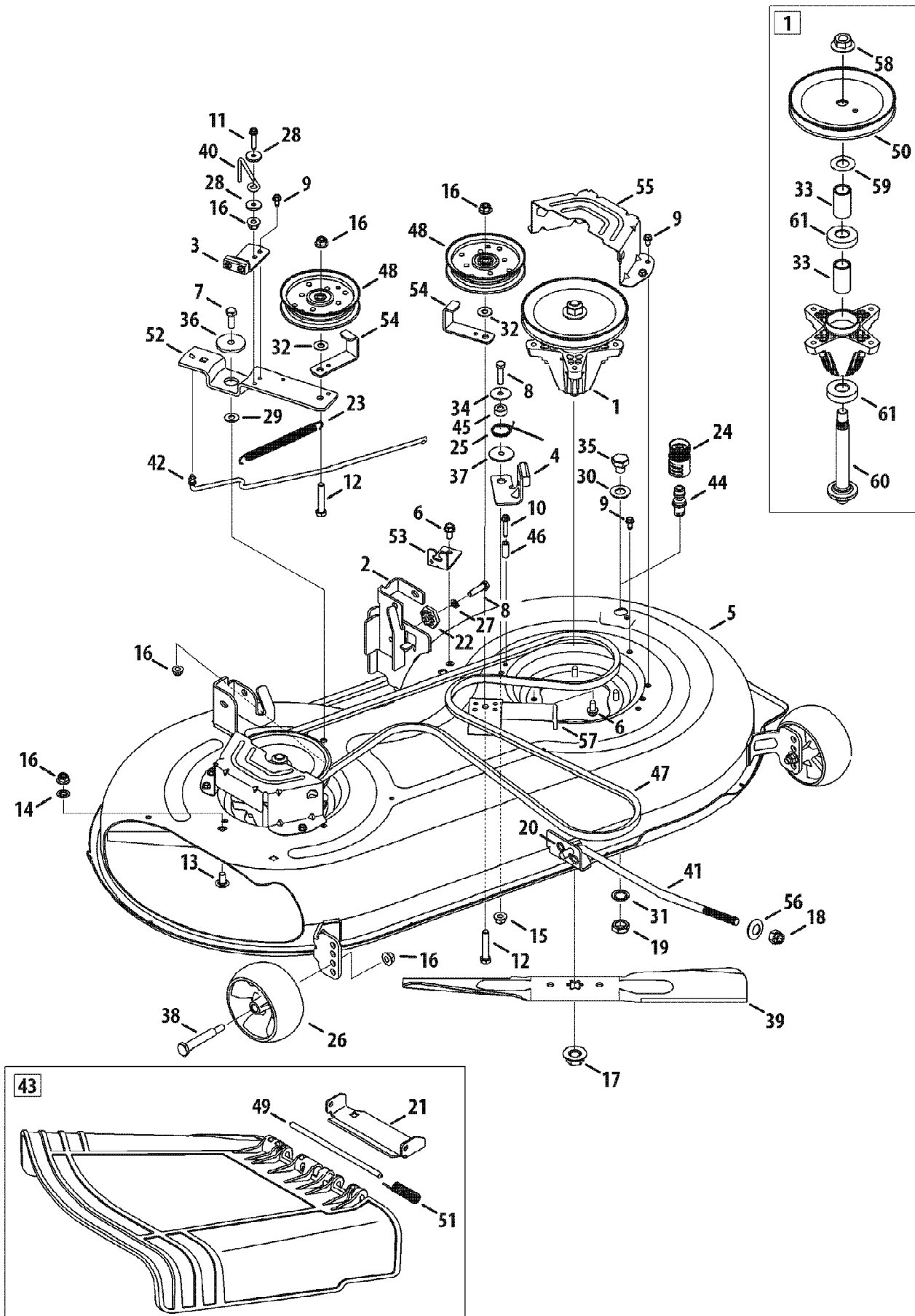

13AN77KS066 Pony (2010)  
Mower Deck 42-Inch

Page 14 of 21

Ref #	Part Number	Qty	S/P/F	Description
1	918-04822A	1	/P	Spindle Assembly, Pulley, 6.3 Dia
2	683-0254B-0637	1	/P	Bracket Assembly, Deck, Hngr Lh Lt
3	983-04511	1	/P	Brake Assembly, Deck, 42/46
4	983-04525	1	/P	Brake Assembly, Deck, 46"
5	983-04570-0637	1	/P	Deck Assembly, Sd, Offset, 42 W/O Wheels
5	983-04572-0637	1	/P	Deck Assembly, Sd, Offset, 42 W/ 2Wheels
6	710-04484	1		Screw, Tt, 5/16-18, .750, Hxindwsh
7	710-0514	1	/P	Hhcs, 3/8-16, 1.00, Gr5, Std
8	710-0528	1	/P	Hhcs, 5/16-18, 1.25, Gr5, Std
9	710-0599	1	/P	Screw, Tt, 1/4-20, 0.500, Hxindwsh
10	710-0778	1	/P	Screw, Tt, 1/4-20, 1.500, Hxindwsh
11	710-0809	1		Screw, Tt, 1/4-20, 1.250, Hxindwsh
12	710-3144	1	/P	Hhcs, 3/8-16, 2.00, Gr5, Std
13	710-3178	1	/P	Bolt, Crg, 3/8-16, 0.75, Gr1
14	712-0229	1		Nut, Push, 3/8
15	712-04063	1	/P	Nut, Flglk, 5/16-18, Grf, Nylon
16	712-04065	1	/P	Nut, Flglk, 3/8-16, Grf, Nylon
17	712-0417A	1	/P	Nut, Flg, 5/8-18
18	712-04243	1		Nut, Flxlk, 1/2-13
19	912-0641	1	/P	Nut, Hex, M16-1.5 Din 936
20	714-04043	1		Bow-Tie Cotter Pin
21	783-06074A	1		Chute Bracket
22	917-04074	1	/P	Gear, Deck, Adj
23	932-0384	1	/P	Spring, Extension, .62 Dia X 6.12 Lg
24	921-04041	1	/P	Water Nozzle Adapter
25	732-04727	1		Spring, Torsn, .992 I.D X 1.17 O.D
26	734-04155	1		Wheel, Deck, 5.0 Dia Ball
27	936-0119	1	/P	Washer, Lock, 5/16, Regular Duty
28	936-0176	1	/P	Washer, Flat, .265 X .938 X .120
29	936-0344	1	/P	Washer, Flat, .385 X 1.0 X .030
30	736-0187	1	/P	Washer, Flat, .64 X 1.24 X .06, Ht
31	736-0225	1	/P	Washer, Lock, 5/8, Int Tooth
32	736-0262	1	/P	Washer, Flat, .385 X .870 X .092
33	750-04936	1		Spacer, .792 X 1.060 X 1.860 Lg
34	736-0362	1	/P	Washer, Flat, .330 X 1.25 X .06, Ht
35	738-04146	1		Plug, Bolt, M16 X 1.5
36	738-04162A	1	/P	Spacer, Shoulder, .8840 X .190
37	738-04166	1		Spacer, Shoulder, .5000 X .1475
38	938-3056	1	/P	Bolt, Shoulder, .496 X 2.50, 3/8-16
39	942-04308	1	/P	Blade, Cut, 21.23" 2-In-1
40	747-04530	1		Rod, Keepr, Belt 42 Idler
41	747-04944B	1	/P	Rod, Lift, Deck, Frt, 13.7
42	747-05105	1		Rod, Cont, Brake 42"
43	631-04460	1		Chute Assembly, 42" Deck
44	737-04003D	1	/P	Deck Water Nozzle
45	750-0258	1	/P	Spacer, .315 X .750 X .375 Lg
46	750-0566A	1	/P	Spacer, .260 X .375 X 1.030 Lg
47	954-04060B	1	/P	Belt, V Typ, A Sec X 96.5
48	756-04129B	1	/P	Pulley, Idler, 4.25"Dia
49	711-04847A	1	S	Pin, Hinge, Dia .3125 X 7.96 Lg
50	956-1227	1	/P	Pulley, Deck, 6.3 Dia
51	732-04372	1		Spring, Torsion, .44 I.D. X 2.0
52	783-05946	1		Bracket, Idler, Piv, 46

13AN77KS066 Pony (2010)  
Mower Deck 42-Inch

Page 15 of 21

Ref #	Part Number	Qty	S/P/F	Description
53	783-06243-0637	1		Bracket, Cable, Deck Engage
54	783-06368-0637	1	S	Bracket, Guard, Belt, 4.25 Pulley
55	783-06424A-0637	1		Cover, Belt, Deck, 42
56	748-04069	1		Deck Lift Pivot Cup
57	783-06643-0637	1		Bracket, Supt, Deck Stationary Idler
58	712-0417A	1	/P	Nut, Flg, 5/8-18
59	936-0351	1	/P	Washer, Flat, .760 Idx1.50 Od
60	738-1186A	1		Shaft, Spindle, 6.11 Lg.
61	941-0919	1	/P	Bearing, Ball, .787id X 1.85 Odx.551

13AN77KS066 Pony (2010)  
Quick Reference Pony

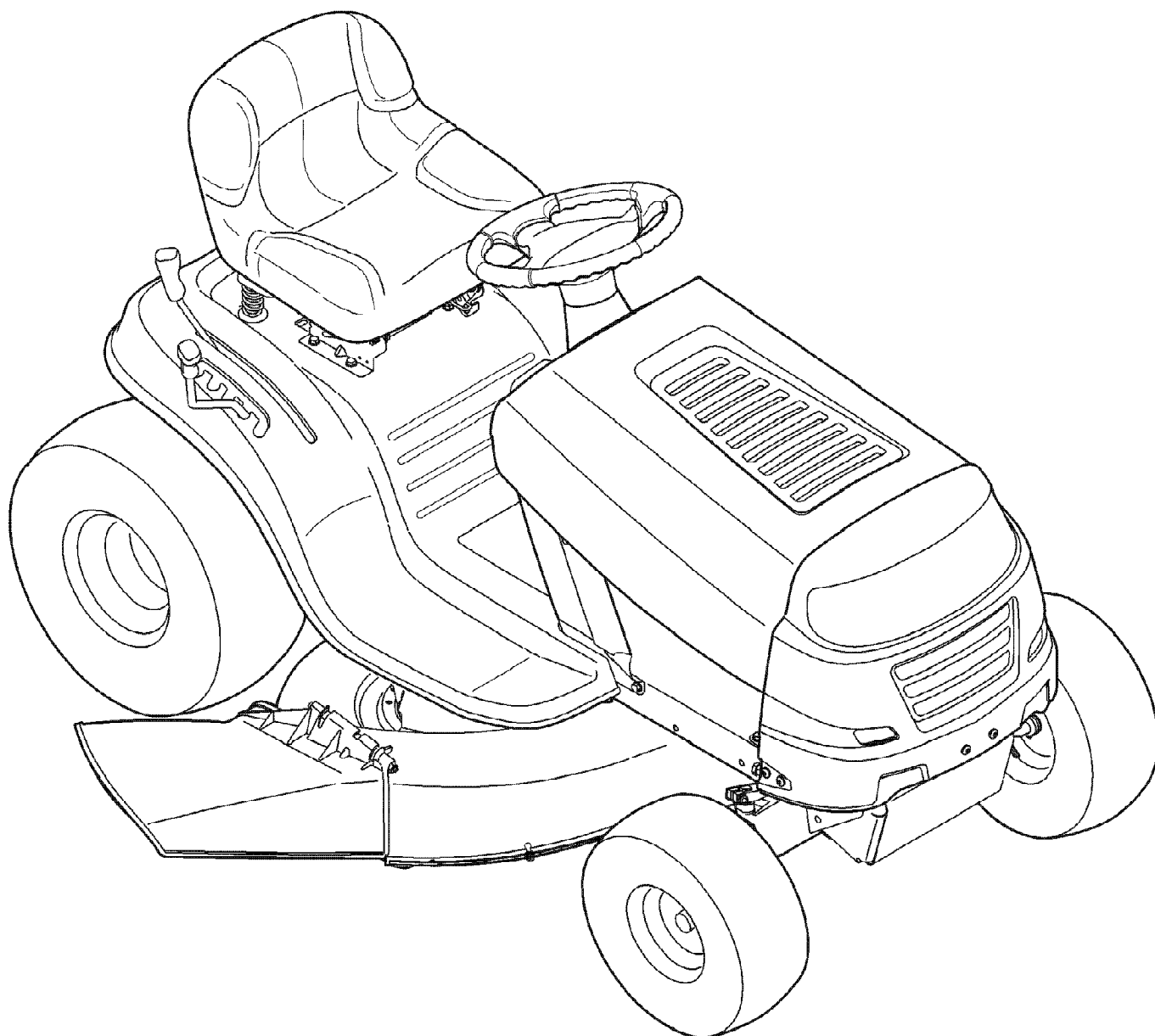



13AN77KS066 Pony (2010)  
Quick Reference Pony

Page 17 of 21

Ref #	Part Number	Qty	S/P/F	Description
	759-3336	1	/P	Spark Plug
	BS-492932S	1	/P	Oil Filter
	BS-697015	1	/P	Pre Filter
	BS-795115	1	/P	Air Filter
	951-3013	1	S	Fuel Filter
	751-0603A	1	/P	Fuel Cap Replaces 751-3111
	725-04439	1		Solenoid
	918-04822A	1	/P	Deck Spindles
	942-04308	1	/P	Blades
	712-0417A	1	/P	Blade Nuts
	734-04155	1		Deck Wheels
	923-0448A	1	/P	Ball Joints
	925-1745A	1	/P	Ignition Keys
	N/A	1		Control Cable
	946-04173B	1	S	Deck Engagement Cable
	746-04364	1		Throttle Cable
	954-0241A	1	/P	Upper Drive Belt
	954-04249	1	/P	Lower Drive Belt
	954-04060B	1	/P	Deck Spindle Belt
	N/A	1		PTO Belt
	725-04363	1		Safety Switch - Brake
	725-04363	1		Safety Switch - Deck
	631-04460	1		Discharge Chute
	925-1707D	1	/P	Battery
	19A30006100	1		MULCH KIT 42" Attachments
	19A30003OEM	1		BAGGER 42" Attachments
	OEM-190-679	1	/P	BUMPER KIT Attachments
	OEM-190-607	1		SUNSHADE Attachments

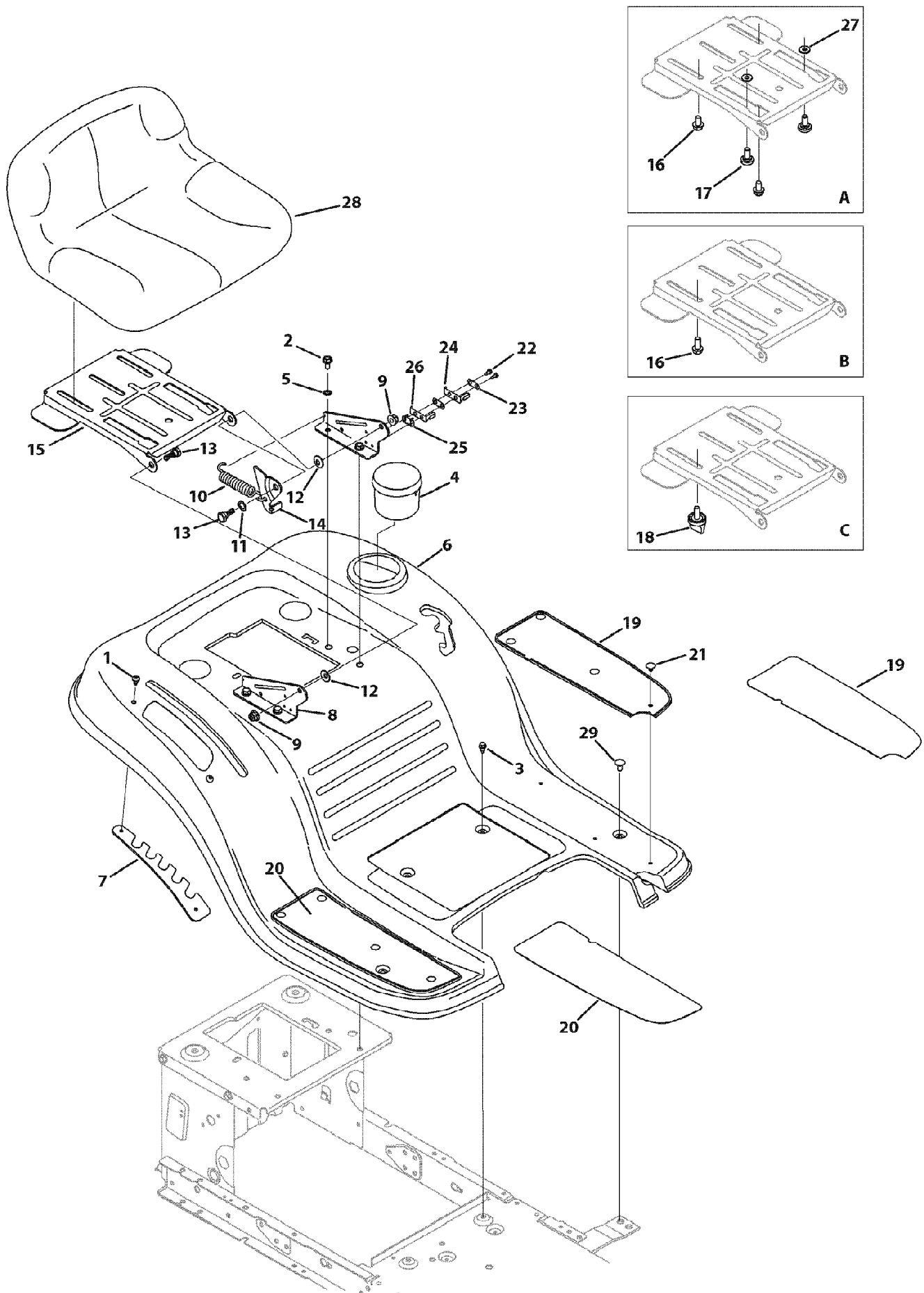

13AN77KS066 Pony (2010)  
Seat and Fender

Page 19 of 21

Ref #	Part Number	Qty	S/P/F	Description
1	710-04483	1		Screw, 1/4-20 x .500
2	710-04484	1		Screw, 5/16-18 x .750
3	710-0599	1	/P	Screw Pan Torx Head, 1/4-20 x .500
4	731-04591A	1	/P	Cup Holder
5	736-0607	1	/P	Lock Washer, 5/16
6	783-04587C-0638	1		Fender - Red
7	783-04843-0637	1		Lift Adjuster Bracket - Powder Black
8	783-1489C-0637	1	/P	Seat Mount Bracket - Powder Black
9	712-04063	1	/P	Flangelock Nut, 5/16-18
10	732-1184	1	/P	Extension Spring
11	936-0108	1	/P	Flat Washer, .510x .750 x .033
12	736-0242	1	/P	Bell Washer, .340 x .872 x .060
13	938-0296	1	/P	Shoulder Screw, 5/16-18 x .437 x .268
14	783-0209D	1	/P	Lift Seat Bracket
15	783-04081C-0637	1	/P	Pivot Seat Manual Adjust Bracket
16	710-04482	1		Hex Head Flange, 3/8-16 x .875
17	738-04012A	1	/P	Shoulder Screw, 3/8-16 x .625 x .145
18	720-04061	1		Knob, 3/8-16 x .875
19	735-04047	1		Foot Pad, LH
19	723-04026	1		Foot Pad, Abrasive, LH If equipped
20	735-04048	1		Foot Pad, RH
20	723-04025	1		Foot Pad, Abrasive, RH If equipped
21	726-04072A	1	/P	Ratchet Clip, .250 x .500
22	710-0227	1	/P	Screw, 8-18 x .500
23	726-0279	1		Insulator Plate
24	925-1303	1	/P	Outer Seat Spring
25	726-0278	1		Insulator Boss Plate
26	725-1439	1		Inner Seat Spring
27	936-0140	1	/P	Flat Washer, .385 x .62 x .063
28	757-04099	1		Low Back Seat, Black, Set-up B or C
29	710-0134	1	/P	Screw Carriage, 1/4-20 x .62

13AN77KS066 Pony (2010)  
Steering

Page 20 of 21

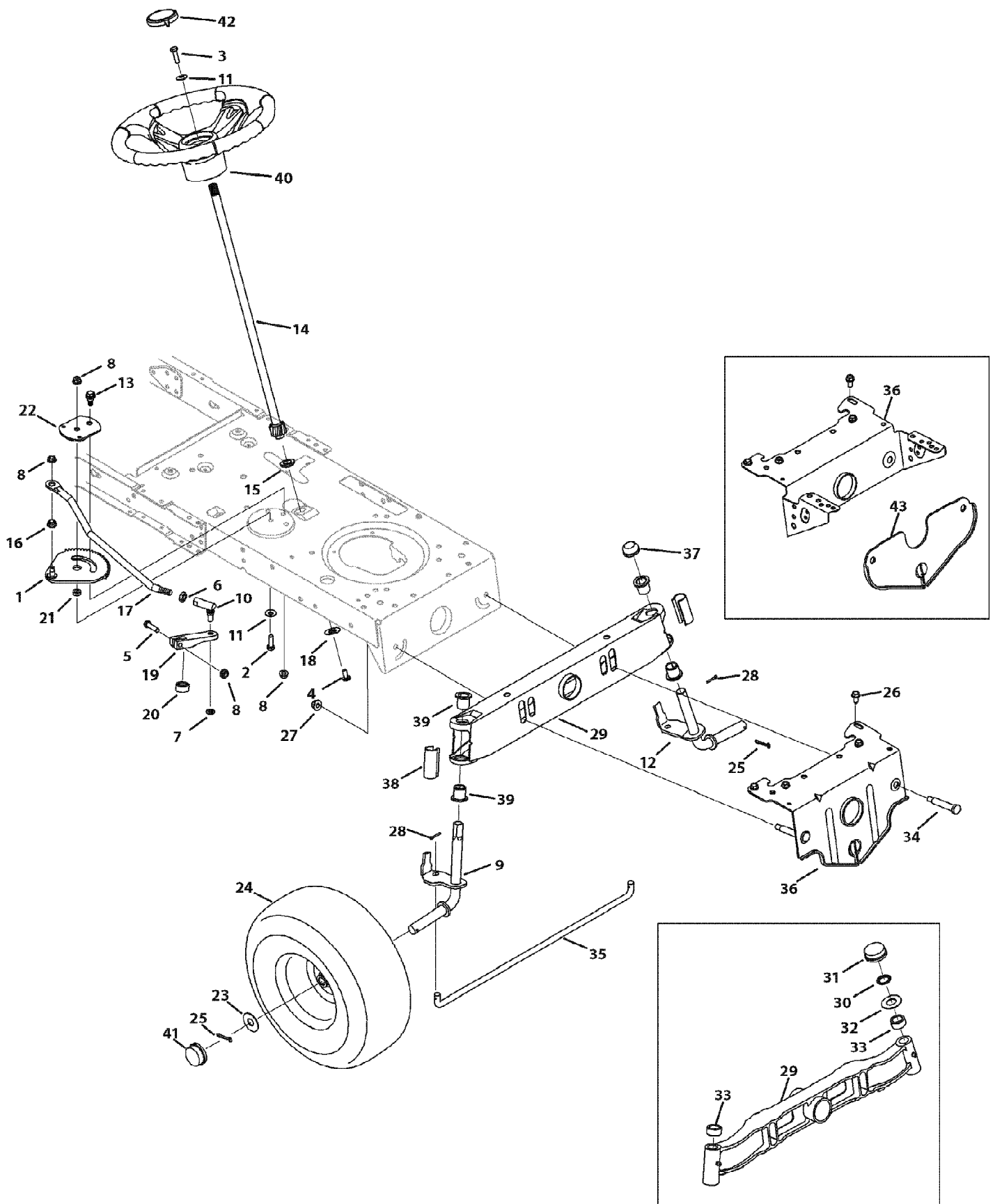

13AN77KS066 Pony (2010)  
Steering

Page 21 of 21

Ref #	Part Number	Qty	S/P/F	Description
1	617-04024	1	S	Front Steering Gear Assembly
2	710-0376	1	/P	Hex Screw, 5/16-18 x 1.00
3	710-0643	1	/P	Hex Screw, 5/16-18 x 1.00, Lock
4	710-1309	1	/P	Machine Screw, 5/16-18 x .750
5	710-3180	1	/P	Hex Screw, 5/16-18 x 1.75
6	912-0240	1	/P	Jam Nut, 7/16-20
7	912-0214	1	/P	Jamlock Nut, 3/8-24
8	712-04063	1	/P	Flangelock Nut, 5/16-18
9	638-04008P	1	/P	Front RH Axle
10	923-0448A	1	/P	Ball Joint, 7/16-20
11	736-0242	1	/P	Bell Washer, .340 x .872 x .060
12	938-04007A-0637	1	/P	Front LH Axle
13	738-04141	1		Shoulder Bolt, 5/16-18 x .435 x .350
14	738-0919A	1	/P	Steering Shaft, 5/8 x 22.08
15	941-04124	1	/P	Flange Bearing, 5/8
16	941-0475	1	/P	Plastic Bushing, .380 ID
17	747-04298	1		Steering Link
18	948-0389	1	/P	Cap, 1.25 x .16
19	748-04065-0637	1	/P	Steering Block
20	748-04068	1		Spacer, .71 x .125 x .56
21	750-04418	1		Spacer, .322 x .625 .21
22	783-04644	1	S	Gear Segment Stabilizer Plater
23	736-04228A	1		Flat Washer, .781 x 1.590
24	634-04325-0911	1		Wheel Assembly, 42"/38" Grey
24	734-04240A	1		Tire Only, 15 x 6 x 6, Round Shld. Not shown
24	634-04081	1	S	Rim Assembly (Incl. bearings & valve stem) Not shown
24	741-0516B	1	/P	Flange Bearing, Not shown
24	741-0990B	1	/P	Flange Bearing, w/grease fitting Not shown
24	734-0255	1	S	Valve, Air Not shown
25	714-04039	1		Cotter Pin, 5/32 x 1.25
26	710-04484	1		Screw, 5/16-18 x .750
27	712-04065	1	/P	Flangelock Nut, 3/8-16
28	914-0474	1	/P	Cotter Pin, .125 x .75
29	683-0128B-0638	1		Pivot Axle - Red
30	726-04035	1		Push Nut, 3/4
31	731-04693	1		Hub Cap
32	936-0316	1	/P	Flat Washer, .78 x 1.59 x .060
33	748-04068	1		Spacer, .71 x .125 x .56
34	738-04128	1		Shoulder Bolt, 3/8-16 x .500 x 2.38
35	747-04299A	1	/P	Fixed Rod
36	783-05326-0637	1	/P	Pivot Bar Bracket
36	783-04601C-0637	1		Pivot Bar Bracket
37	726-0341	1	/P	Push Cap, 3/4
38	731-04057A	1		Standard Axle Cap
39	741-0660A	1	/P	Flange Bearing, .760 x .941 x 1.0
40	631-04028	1		Steering Wheel
41	931-0484A	1	/P	Hub Cap
42	731-04681	1		Cap, Troy-Bilt
43	783-04568-0637	1		Front Deck Hanger Bracket