

13AN77KG011 Pony (2008)
Deck Assembly

Page 2 of 24

Ref #	Part Number	Qty	S/P/F	Description
1	618-04456	1	S	Spindle Assembly, Pul, 6.3" Dia
1	712-0417A	1	/P	Flange Nut:5/8-18 Not shown
1	938-04241	1	/P	Spindle Shaft:5.50 LG Not shown
1	941-0919	1	/P	Ball Bearing:20x47x14:62 Not shown
1	750-04739	1		Spacer:.820x 1.150 x .480 Not shown
1	750-1000	1		Spacer:.80 x 1.10 x 1.322 Not shown
1	956-1227	1	/P	Deck Pulley:6.3 Dia Not shown
2	683-04138B	1	/P	Brake Assembly, Deck
3	683-04165A	1	S	Deck Shell, 42" (w/o Wheel Brackets)
3	683-04162A	1	S	Deck Shell, 42" (w/ Wheel Brackets)
4	683-04167	1	S	Brake Assembly, Deck
5	683-04228	1		Brkt. Ass'y, Deck, Hanger LH
6	710-3015	1	/P	Screw, 1/4-20, .75, Gr5
7	736-0267	1	S	Washer, Flat, .385 x .75 x .062
8	710-0528	1	/P	Screw, 5/16-18, 1.250
9	710-04484	1		Screw, 5/16-18, 0.750
10	710-3085	1	/P	Screw, 3/8-16, 3.50, Gr5
11	710-0778	1	/P	Screw, 1/4-20, 1.500
12	710-3008	1	/P	Screw, 5/16-18, .75, Gr5
13	710-0134	1	/P	Carriage Screw, , 1/4-20 x .62 If Equipped
14	737-04003C	1	S	Deck Water Nozzle If Equipped
15	712-3006	1	/P	Nut, Hex, 1/4-20, Gr5
16	712-0417A	1	/P	Nut, Flange, 5/8-18
17	738-0373	1	S	Screw, Shldr, .498 x 1.53, 3/8-16
18	712-04063	1	/P	Nut, Flange Lock, 5/16-18, GrF
19	712-04065	1	/P	Nut, Flange Lock, 3/8-16, GrF
20	712-0641	1	S	Nut, Hex, M16-1.5 If Equipped
21	712-3083	1	/P	Nut, Hex Lock, 1/2-13, Gr8
22	712-0206	1	S	Nut, Hex, 1/2-13, Gr5
23	714-0104	1	S	Pin, Cot, .072 Dia. x 1.13 Lg
24	717-04074	1	S	Gear, Deck Adjustment
25	726-0233	1	/P	Nut, Push, .25 ID x .50 OD
26	732-04280B	1	/P	Spring, Exten. , .75 Dia. x 6.375
27	732-04287	1		Spring, Exten. , .50 Dia. x 6.375
28	734-0973	1	/P	Wheel, Deck 5.0 x 1.38 If Equipped
29	736-0119	1	S	Washer, Lock, 5/16
30	736-0270	1	/P	Washer, Bell, .265 x .75 x .062
31	783-04740	1		Deck Engagement Cable Bracket
32	736-0300	1	S	Washer, Flat, .406 x .875 x .059
33	736-0225	1	/P	Washer, Lock, 5/8, Internal Tooth If Equipped
34	736-0187	1	/P	Washer, Flat, .64 x 1.24 x .06 If Equipped
35	738-04166	1		Spacer, Shoulder, .5000 x .1475
36	738-04146	1		Plug, Screw, M16 x 1.5 If Equipped
37	738-04162A	1	/P	Spacer, Shoulder, .8840 x .190
38	742-0616A	1	S	Blade, 21.23", Star 3-in-1
39	731-2363	1	/P	Mulch Plug If Equipped
40	747-04379A	1	/P	Control Rod, Brake
41	747-04269A	1	/P	Deck Rod, Front Adjustable
42	748-04069	1		Pivot Cup, Deck Lift
43	750-0566A	1	/P	Spacer, .260 x .372 x 1.030
44	754-04060B	1	S	Belt, V-Type
45	756-04129	1	S	Idler Pulley, 4.25" Dia.

13AN77KG011 Pony (2008)
Deck Assembly

Page 3 of 24

Ref #	Part Number	Qty	S/P/F	Description
46	712-3087	1	/P	Wing Nut, 1/4-20 If Equipped
47	783-04327B	1		Cover, Belt, 6.00 Dia.
48	750-04446	1		Spacr, 3/8 ID x .68 OD x 1.46 Lg.
49	710-0347	1	/P	Screw, 3/8-16 x 1.75
50	731-1032B	1	S	Chute Assembly, Discharge
51	712-0229	1		Nut, Push, 3/8
52	710-0599	1	/P	Screw, 1/4-20, 0.500 If Equipped
53	783-1146A	1	S	Deck Skirt If Equipped
54	721-04041	1	S	Water Nozzle Adapt If Equipped

13AN77KG011 Pony (2008)
Drive Assembly

Page 5 of 24

Ref #	Part Number	Qty	S/P/F	Description
1	918-04566	1	/P	Transmission
2	647-04035	1		Lever Assembly, Shift
3	710-0176	1	/P	Screw, 5/16-18, 2.75 (38/42" Decks)
4	710-0227	1	/P	Screw, #8-18, 0.500
5	710-04484	1		Screw, 5/16-18, 0.750
6	710-0809	1		Screw, 1/4-20, 1.250
7	710-3008	1	/P	Screw, 5/16-18, .75, Gr5
8	711-04075A	1	S	Ferrule, 3/8-24 x .375 Dia.
9	712-04063	1	/P	Nut, Flange Lock, 5/16-18, GrF
10	712-0700	1	/P	Nut, Flange, 9/16-18, Gr2
11	714-0111	1	S	Pin, Cotter, 3/32, 1.0
12	714-0209	1	S	Cotter Pin, Internal .125 Dia
13	714-0470	1	S	Pin, Cotter, 1/8 x 1.25
14	718-0758A	1	S	Hub, Pulley, 5/8 Spline
15	720-04028	1		Knob, Shift
16	725-1644	1		Spring Switch, Short
17	710-0520	1	/P	Screw, 3/8-16 x 1.50
18	726-0320	1	S	Plate, Insulator Nut
19	731-04602	1		Sleeve, .758 x .821 x 3.3125
20	731-04604	1		Sleeve, .758 x .821 x 2.4375
21	732-04076A	1	/P	Spring, Extension, 1.15 OD x 7.90
22	732-04488	1		Spring, Extension
23	732-04306	1		Spring, Extension, .80 OD x 3.28
24	732-0716C	1	S	Spring, Extension, .59 OD x 4.00
25	736-0264	1	S	Washer, Flat, .330 x .630 x .0635
26	747-04265	1		Variable Speed Control Rod
27	747-04277	1		Rod, Shift (38/42" Decks)
28	747-04733	1		Rod, Brake
29	750-0566A	1	/P	Spacer, .260 x .372 x 1.030
30	754-04001A	1	S	Belt
31	754-0241A	1	S	Belt
32	756-04002	1	S	Pulley, V-Type, 7.25 Dia
33	783-04595	1		Shift Bracket, Adjustable
34	748-0334	1	S	Spacer .68 (46" Deck Only)
35	710-0224	1	S	Screw, #10, 0.500
36	725-04363	1		Switch, Interlock
37	647-04034C	1		Pedal Assembly, Drive
38	783-04903	1		Latch Bracket (No RMC)
39	710-3144	1	/P	Screw, 3/8-16, 2.00, Gr5
40	710-0347	1	/P	Screw, 3/8-16 x 1.75
41	710-04483	1		Screw, 1/4-20, 0.500
42	711-0736	1	/P	Adjustment Ferrule 1/4-20
43	712-04065	1	/P	Nut, Flange Lock, 3/8-16, GrF
44	731-05361	1		Control Cover
45	726-0214	1	/P	Push Cap, 5/8
46	735-0239	1	/P	Pad, Foot, 4.0
47	683-04225	1	S	Shift Cont. Assembly, 6-Spd
47	683-04216	1	S	Shift Cont. Assembly, 7-Spd
47	683-04274	1	S	Shift Cont. Assembly, 7-Spd Troy-Bilt
48	747-04430	1		Control Rod, Speed Selector
49	736-0133	1	S	Washer, Flat, .411 x 1.25 x .100
50	750-04465	1		Spacer, Flge, .390 x .671 x 1.095
51	750-0802	1		Spacer, .640 ID x .76 OD x 2.63

13AN77KG011 Pony (2008)
Drive Assembly

Page 6 of 24

Ref #	Part Number	Qty	S/P/F	Description
52	783-04536	1		Support Bracket, Pedal
53	683-04207	1		Bracket, Idler
54	683-04176A	1	/P	Torque Bracket, Transmission
55	710-0604A	1	/P	Screw, 5/16-18, 0.625
56	710-1260A	1	/P	Screw, 5/16-18, 0.750
57	732-0627	1		Shift Lever Spring
58	783-04830	1		Control Bracket
59	710-1325	1	/P	Screw, 1/4-20 x 1.625
60	750-04456	1		Spacer, .260 x .372 x 1.420
61	738-0347	1	S	Spacer, Shoulder, .625 ID x .169
62	756-04325	1	/P	Pulley, V Idler A x 3.06
63	656-04015	1	S	Pulley Ass'y, Variable Speed
64	683-04206	1		Bracket Ass'y, Variable Speed
65	710-0627	1	/P	Screw, 5/16-24, .750, Gr5
66	710-0778	1	/P	Screw, 1/4-20, 1.50
67	718-04261	1		Cup, Bearing
68	736-0362	1	/P	Washer, Flat, .330 x 1.25 x .06
69	741-0124	1	S	Bearing, Ball, 17 x 40 x 12
70	736-0242	1	/P	Bell Washer, .34 x .872 x .060
71	634-04324	1		Wheel Ass'y, Round Shoulder
71	734-04241	1		Tire Only, 20 x 8 x 8, Round Shld.
71	634-0070	1	/P	Rim Assy. (Inc. bearings, valve stem)
71	634-0104	1		Wheel Ass'y, Square Shoulder
71	734-1730	1		Tire Only, 20 x 8 x 8, Square Shld
71	734-0603A	1	S	Rim Assy. (Inc. bearings, valve stem)
72	710-0599	1	/P	Screw, 1/4-20 x .500

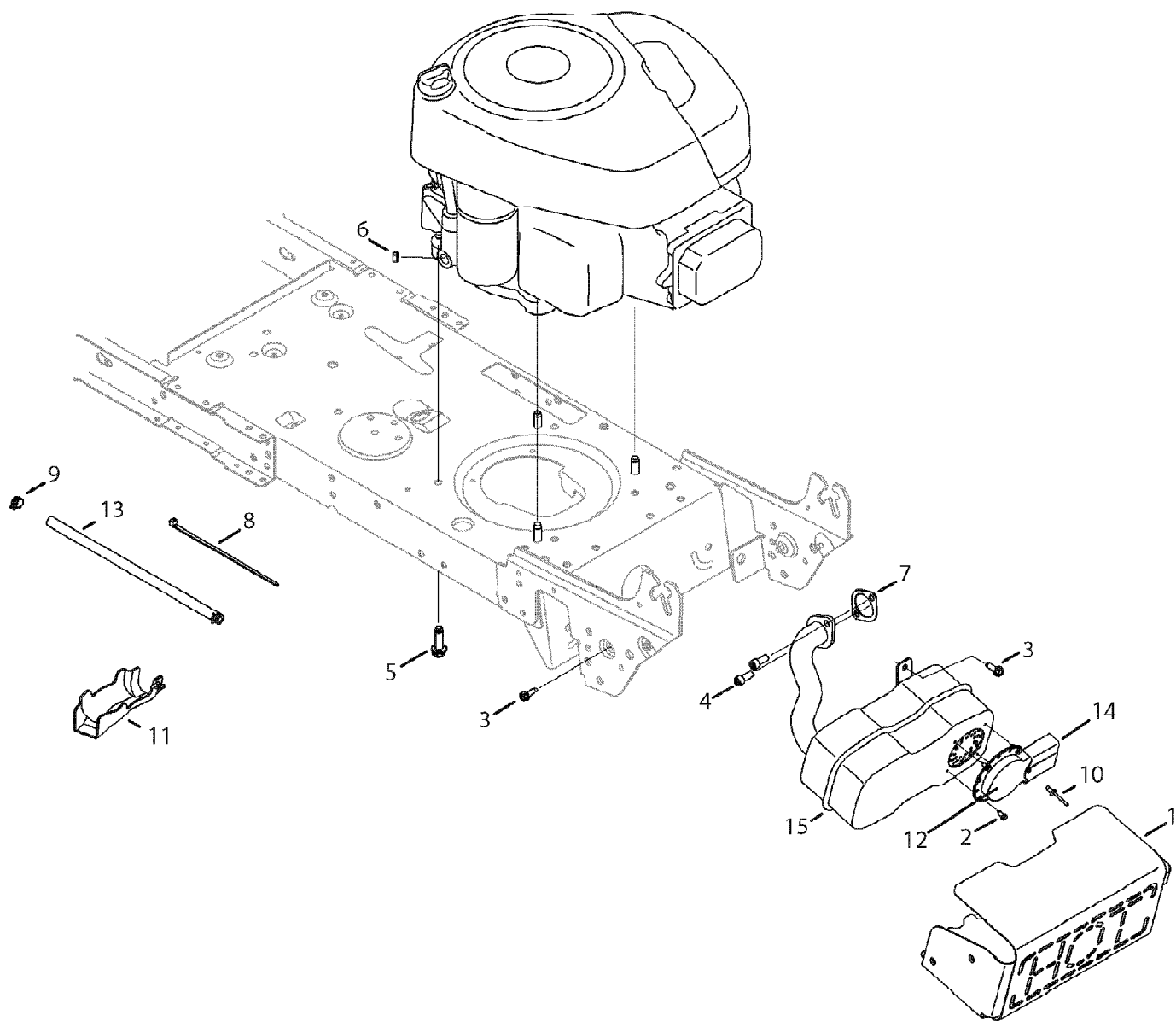

13AN77KG011 Pony (2008)
Engine Accessories

Page 8 of 24

Ref #	Part Number	Qty	S/P/F	Description
1	683-04370	1	S	Muffler Shield Assembly
2	710-0227	1	/P	Screw, #8-18 x .50
3	710-0642	1	/P	Self-tapping Screw, 1/4-20, .750
4	710-1314A	1	/P	Socket Cap Screw, 5/16-18, .625
5	710-1315	1	/P	Self-tapping Screw, 3/8-16, 1.250
6	712-0271	1	/P	Hex Sems Nut, 1/4-20
7	721-0208	1	S	Exhaust Gasket
8	725-0157	1	/P	Cable Tie, 7.4"
9	726-0205	1	/P	Hose Clamp, .490
10	728-04000	1		Pop Rivet, .188 x .300
11	731-05628	1		Oil Drain Sleeve
12	751-0564B	1	/P	Muffler Deflector
13	751-10349	1		Fuel Line Hose
14	751-10353	1		Muffler Deflector, Long
15	751-10448	1	S	Muffler

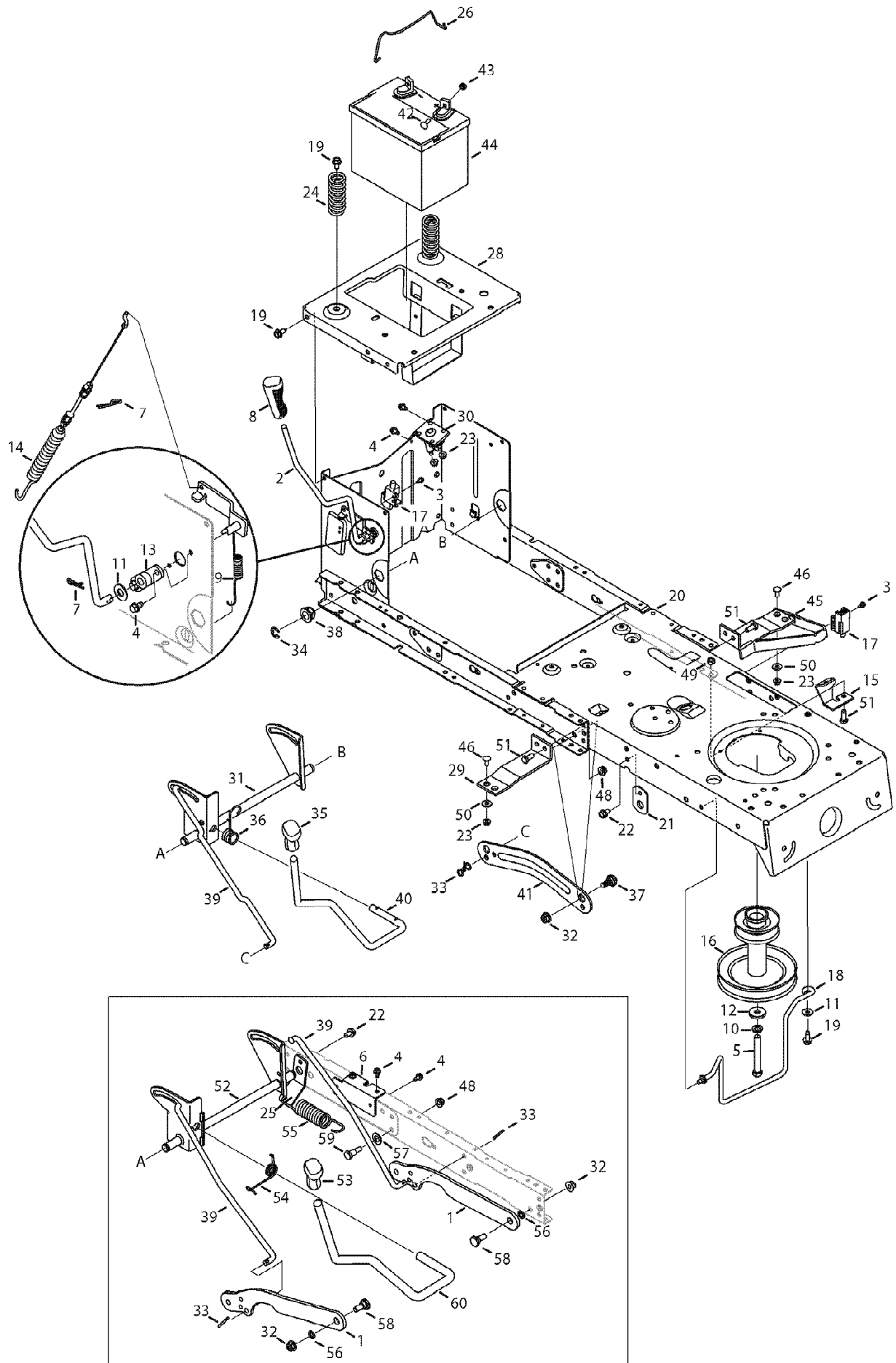

Ref #	Part Number	Qty	S/P/F	Description
1	783-0678C	1	/P	Deck Lift Link
2	647-04096	1		Handle Asswmbly, PTO
3	738-04237	1		Shoulder Screw, #10-16, 0.500
4	710-0599	1	/P	Screw, 1/4-20, 0.500
5	710-04608	1		Screw, 7/16-20, 3.25 38 & 42" Dk.
6	783-05389	1	S	Frame Brace Bracket
7	714-0145	1	S	Pin, Click, .092 x 1.64
8	720-04049A	1	/P	Grip, Handle, 3/8
9	732-04276A	1	/P	Spring, Extension
10	736-0171	1	S	Washer, Lock, 7/16
11	736-0300	1	S	Washer, Flat, .406 x .875 x .059
12	736-0322	1	/P	Washer, Flat, .450 x 1.250 x .164
13	741-04119	1	S	Bearing, PTO
14	746-04173B	1	S	Cable, Deck Engagement
15	783-04753	1		Frame Support Bracket
16	756-04196A	1	/P	Engine Pulley, 38" & 42" Deck
16	756-04207A	1	/P	Engine Pulley, 46" Deck
17	725-04363	1		Switch, Interlock
18	683-04443	1	S	Rod, Belt Keeper (42" Deck)
19	710-04484	1		Screw, 5/16-18, .750
20	683-04163B	1		Frame Assembly
21	783-04536B	1	S	Pedal Support Bracket
22	710-0604A	1	/P	Screw, 5/16-18, 0.625
23	712-04064	1	/P	Nut, Flange Lock, 1/4-20, GrF
24	732-04035	1		Spring, Compr. , 1.28 OD x 3.125
25	783-04462	1		Lift Bracket
26	683-04448	1	S	Hold Down Rod, Battery
27	783-04869A	1	S	Bracket, Battery
28	783-04548C	1	S	Seat Bracket, Frame
29	783-04637	1	S	Bracket, Runing Board
30	725-04439	1		Solenoid
31	683-04155A	1	S	Shaft Assembly Lift 38/42" Decks
32	712-04065	1	/P	Nut, Flange Lock, 3/8-16, GrF
33	714-04043	1		Pin, Cotter .08 x 1.56 Intern. RH
33	714-0470	1	S	Pin, Cotter .080 x 1.25 Intern. LH
34	716-0106A	1		Ring, E-Type, .625 Dia.
35	720-0311	1		Grip, Handle, 1/2
36	732-04225	1		Spring, Torsion 38/42" Decks
37	738-04130	1		Screw, Shldr. , .625 x .175, 3/8-16
38	741-0225	1	S	Bearing, Hex Flange
39	747-04393	1		Rod, Lift
40	747-04282	1		Deck Handle, Lift, 38/43" Decks
41	783-04494	1		Lift Arm, Deck - RH
41	783-04711	1		Lift Arm, Deck - LH
42	710-04666	1		Screw, Carriage, 1/4-20, .75, Gr5
43	712-0271	1	/P	Nut, Sems, 1/4-20
44	725-1737A	1	S	Battery, 190 CCA
44	725-1704A	1	S	Battery, 125 CCA
45	683-04195	1		Support Bracket Assembly
46	710-0134	1	/P	Carriage Screw, 1/4-20 x .62
47	710-3025	1	/P	Screw, 5/16-18 x .625
48	712-04063	1	/P	Flange Lock Nut, 5/16-18
49	712-0429	1	S	Hex Lock Nut, 5/16-18

13AN77KG011 Pony (2008)
Frame & PTO Assembly

Page 11 of 24

Ref #	Part Number	Qty	S/P/F	Description
50	736-0173	1	/P	Flat Washer, .28 x .74 x .063
51	710-3008	1	/P	Hex Screw, 5/16-18 x .75
52	683-04334	1	S	Shaft Assembly Lift 46" Decks
53	720-0298	1		Grip, Handle, 5/8
54	732-04438	1		Spring, Torsion 46" Deck
55	732-0934	1		Extension Spring
56	736-0140	1	S	Washer, Flat, .385 x .62 x .063
57	736-0226	1	S	Washer, Flat, .474 x .879 x .064
58	738-0380	1	S	Bolt, Shldr. .500 x .270 3/8-16
59	738-0754	1		Screw, Shldr. , .437 x .54
60	747-04653	1		Deck Handle, Lift, 46" Deck

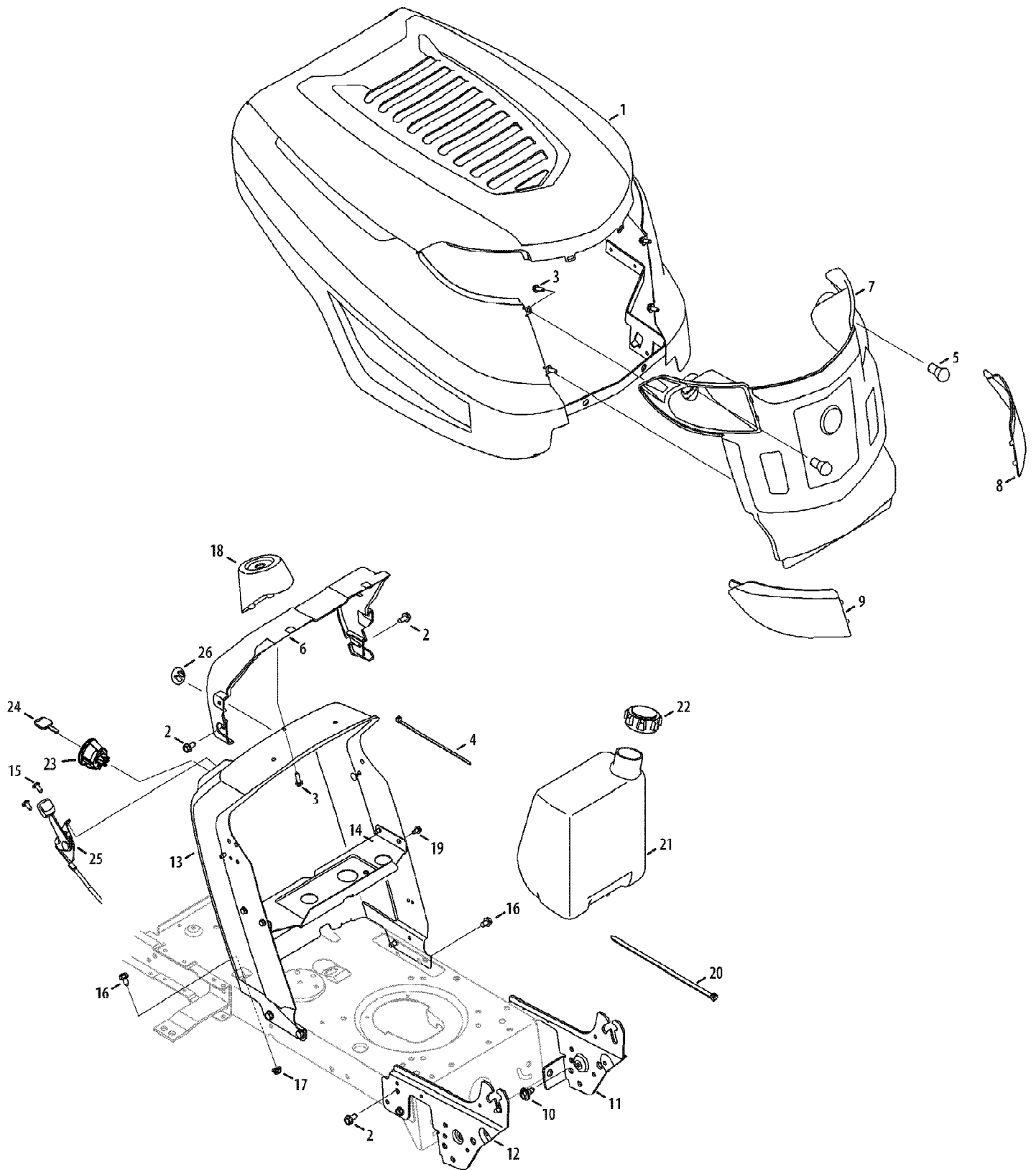

13AN77KG011 Pony (2008)
Hood & Control Assembly

Page 13 of 24

Ref #	Part Number	Qty	S/P/F	Description
1	683-04441	1		K Style Hood Assembly
2	710-04484	1		Screw, 5/16-18, 0.750
3	710-0895	1		Screw, 1/4-15, .750
4	725-0157	1	/P	Cable Tie, 3/16 x .05 x 7.4
5	725-0963	1	S	Headlamp, 12V
6	731-05078C	1	/P	Dash Collar
7	731-06094	1	S	K-Style Grill
8	731-06095	1		Lens, LH
9	731-06096	1		Lens, RH
10	738-04091A	1	/P	Screw, Shldr, .43 x .29, 5/16-18
11	783-05327	1	S	Hood Pivot Bracket, LH
12	783-05328	1	S	Hood Pivot Bracket, RH
13	783-04873	1		Dash Assembly
14	783-04584	1	S	Gas Tank Support Bracket
15	710-04483	1		Screw, 1/4-14, .500
16	710-0604A	1	/P	Screw, 5/16-18, 0.625
17	712-04063	1	/P	Flange Lock Nut 5/16-18
18	731-04945	1		Support, Steering
19	710-0599	1	/P	Screw, 1/4-20, 0.500
20	726-0230	1	/P	Cable Tie, 34.75
21	751-0555B	1	/P	Fuel Tank, 1.5 gal.
22	751-0603	1	S	Fuel Tank Cap
23	725-04659	1	S	Ignition, Switch (No RMC) 3 Position
23	725-1741	1	S	Ignition, Switch (No RMC) 4 Position Not Shown
24	725-1744A	1	S	Key
25	746-04364	1		Throttle/Choke Control, 25.0
26	731-05265	1		Choke Plug
	725-04567	1	S	Wire Harness (No RMC) 3 Position Not Shown
	725-04433A	1	S	Wire Harness (No RMC) 4 Position Not Shown
	777X42188	1		Headlight Lens Reflector RH Not Shown
	777X42187	1		Headlight Lens Reflector LH Not Shown

Ref #	Part Number	Qty	S/P/F	Description
1	777S30018	1	/P	LABEL-DECK SAFETY
2	777S30503	1	/P	LABEL-DANGER CHUTE
3	777D12223	1		LABEL-DECK
4	777I22453	1		LABEL:RIDER LT-5 FENDER
5	777X41701	1		LABEL
6	777D12005	1		LABEL-RIDER REAR FENDER TROY
7	777X43018	1		LABEL-RIDER PARTS LIST 13AN77KG
8	777I22454	1		LABEL:RIDER LT-5 FENDER
9	777S33017	1		LABEL-LT 5 TRANS COVER NO OCR
10	777X43039	1		LABEL-RIDER K STYLE RH
11	777X43038	1		LABEL-RIDER K STYLE LH
12	777D12014	1		LABEL-RIDER HOOD K STYLE TROY
13	777D12110	1		LABEL-RIDER K STYLE HOOD 7SPD TRAN
14	777I22773	1		LABEL-RIDER:SECURE WHEEL
15	777D12111	1		LABEL-RIDER HOOD RH K STYLE TROY
16	777D12112	1		LABEL-RIDER HOOD LH K STYLE TROY
17	777I22479	1		LABEL: RIDER LT-5 THRT/CHK
18	777I22455	1		LABEL:RIDER LT-5 DASH
19	777D11869	1		LABEL-EMBOSSSED TROYBILT

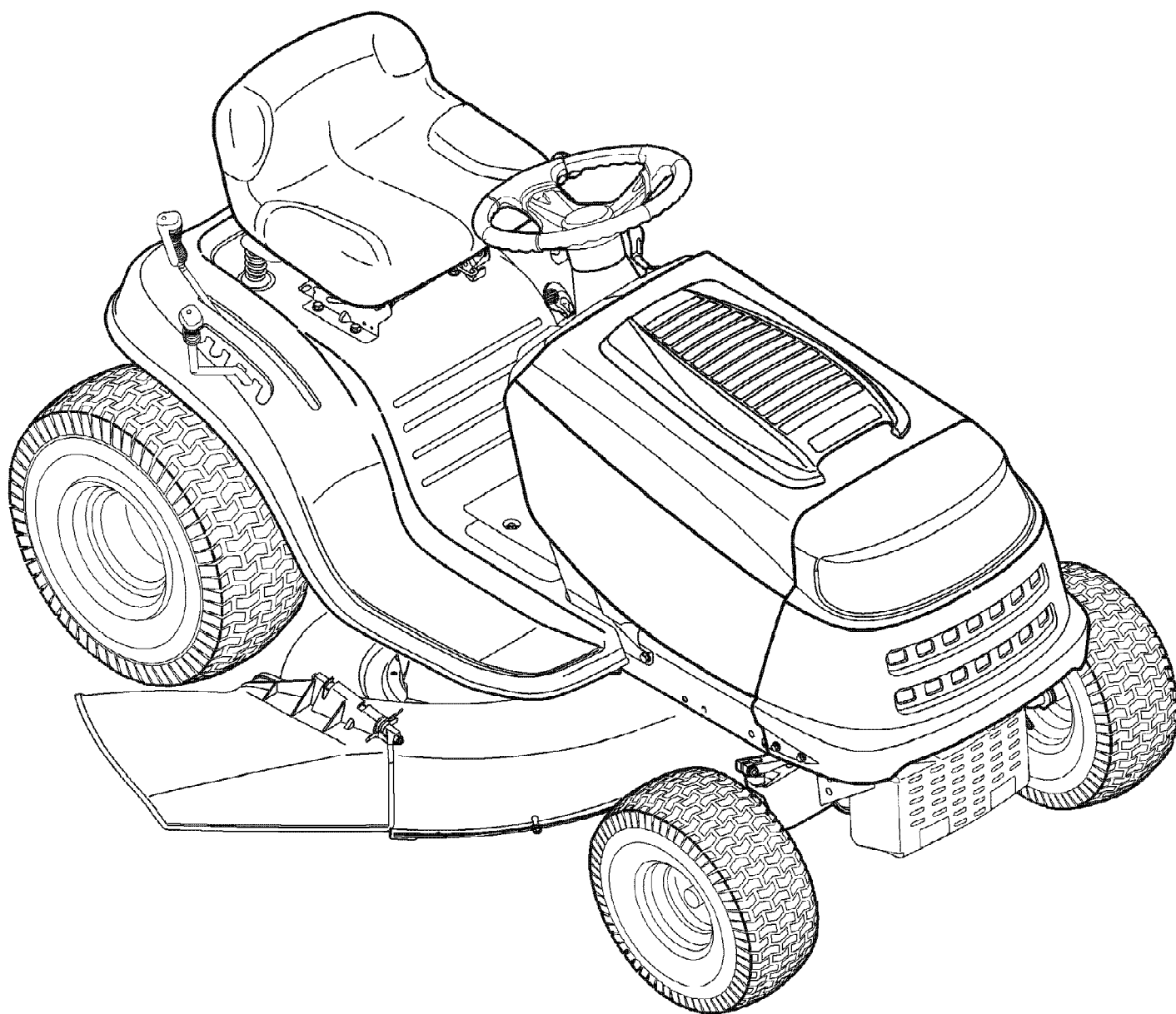

13AN77KG011 Pony (2008)
Quick Reference

Page 17 of 24

Ref #	Part Number	Qty	S/P/F	Description
	NA	1		OIL FILTER
	BS-698083	1	S	AIR FILTER
	BS-697015	1	/P	PRE-CLEANER ELEMENT
	759-3336	1	/P	SPARK PLUG
	951-3013	1	S	FUEL FILTER
	942-0616A	2	/P	BLADES
	712-0417A	1	/P	BLADE NUT
	954-0241A	1	/P	UPPER DRIVE BELT
	954-04001A	1	/P	LOWER DRIVE BELT
	954-04060B	1	/P	DECK SPINDLE BELT
	NA	1		ENGINE TO DECK BELT
	918-04456	2	S	DECK SPINDLES
	925-1745	1	S	IGNITION KEYS
	725-04439	1		SOLENOID
	951-3111	1	S	FUEL CAP
	NA	1		DECK WHEELS
	923-0448A	1	/P	BALL JOINTS
	741-0516B	1	/P	WHEEL BUSHINGS
	741-0990B	1	/P	WHEEL BUSHINGS in board
	725-04363	1		SAFETY SWITCH-DECK
	725-04363	1		SAFETY SWITCH-BRAKE/CLUTCH
	NA	1		WATER NOZZLE ADAPTER
	OEM-190-116	1	/P	Mulch Kit
	OEM-190-180	1	S	Twin Bag Grass Collector
	OEM-190-183	1		Deck Wheel Kit
	490-900-0025	1		Deck Wash Kit
	OEM-190-607	1		Deluxe Tractor Sunshade

13AN77KG011 Pony (2008)
Seat & Fender Assembly

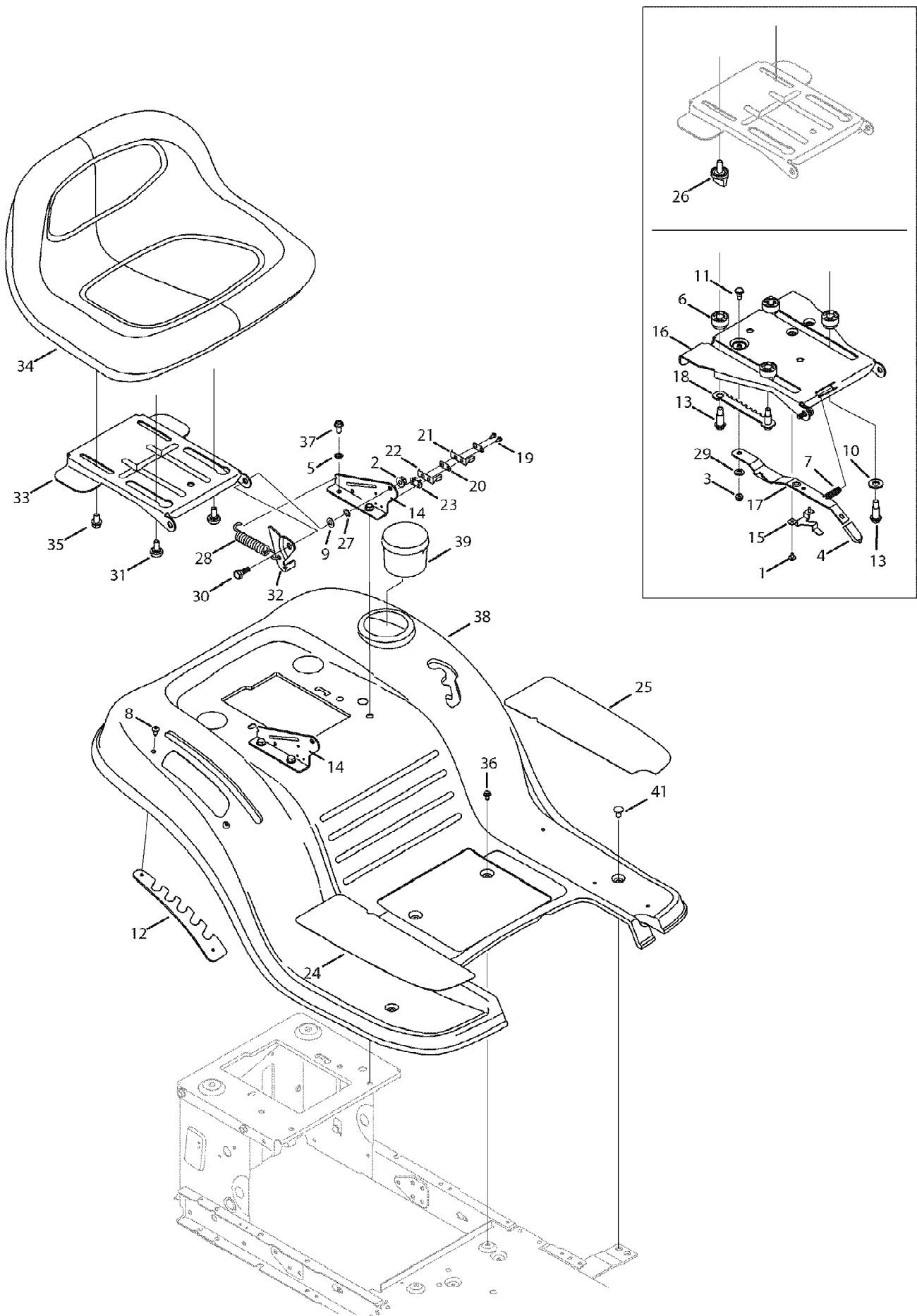

13AN77KG011 Pony (2008)
Seat & Fender Assembly

Page 19 of 24

Ref #	Part Number	Qty	S/P/F	Description
1	710-1268	1	/P	Screw, #10-16, .375
2	712-04063	1	/P	Nut, Flange Lock, 5/16-18, GrF
3	712-04064	1	/P	Nut, Flange Lock, 1/4-20
4	720-0309A	1	/P	Seat Adjuster Grip
5	736-0607	1	/P	Lock Washer, 5/16
6	731-04074	1		Spacer
7	732-0499	1		Compression Spring, .41 x 1.5
8	710-04483	1		Screw, 1/4-20 x .500
9	736-0242	1	/P	Wash, Bell, .340 x .872 x .060
10	736-3019	1		Wash, Flat, .531x 1.062 x.134
11	738-0137A	1	S	Screw, Shlder, .340 x .285,1/4-20
12	783-04843	1		Lift Adjustment Bracket
13	738-0966A	1	/P	Screw, Shlder, .50 x .925, 3/8-16
14	783-1489C	1		Mounting Bracket, Seat
15	783-0611	1		Seat Stop
16	783-0738D	1	/P	Seat Pivot Bracket
17	783-0739A	1	S	Seat Adjustment Lever
18	783-0753	1		Seat Adjustment Selector
19	710-0227	1	/P	Screw, #8-18 x .50
20	726-0279	1		Plate, Insulator
21	725-1303	1	S	Spring Switch, Outer
22	725-1439	1		Spring Switch, Inner
23	726-0278	1		Plate, Insulator Boss
24	723-04025	1		Foot Pad, Abrasive, RH
24	735-04048	1		Foot Pad, Rubber RH
25	723-04026	1		Foot Pad, Abrasive, LH
25	735-04047	1		Foot Pad, Rubber LH
26	720-04061	1		Knob, 3/8-16, .875
27	726-0201	1		Nut, Speed, .3125 Id
28	732-1184	1	/P	Spring, Exten., .84 Dia x 4.6 Lg.
29	736-0204	1	/P	Wash, Flat, .344 x .62 x .033
30	738-0296	1	S	Scr., Shlder, .437 x .268, 5/16-18
31	738-04012A	1	/P	Screw, Shlder, .625 x .175, 3/8-16
32	783-0209D	1	/P	Lift Bracket, Seat
33	783-04081B	1		Pivot Bracket, Seat
34	757-04001A	1	/P	Seat, Low, Black
34	757-04037	1	S	Seat, Medium, Black
34	757-04011	1	S	Seat, Medium, Yellow
34	757-04038A	1	/P	Seat, Medium, Yellow
35	710-04482	1		Screw, 3/8-16, .875
36	710-0599	1	/P	Screw, 1/4-20, 0.500
37	710-04484	1		Screw, 5/16-18, 0.750
38	783-04587A	1		Fender
39	731-04591A	1	/P	Cup Holder
40	736-0300	1	S	Flat Washer, .406 x .875 x .059
40	736-0140	1	S	Flat Washer, .395 x .62 x .063
40	726-04072A	1	/P	Ratchet Clip (For use w/ rubber foot pad)
41	710-0134	1	/P	Carriage Screw, 1/4-20 x .62

13AN77KG011 Pony (2008)
Steering Assembly

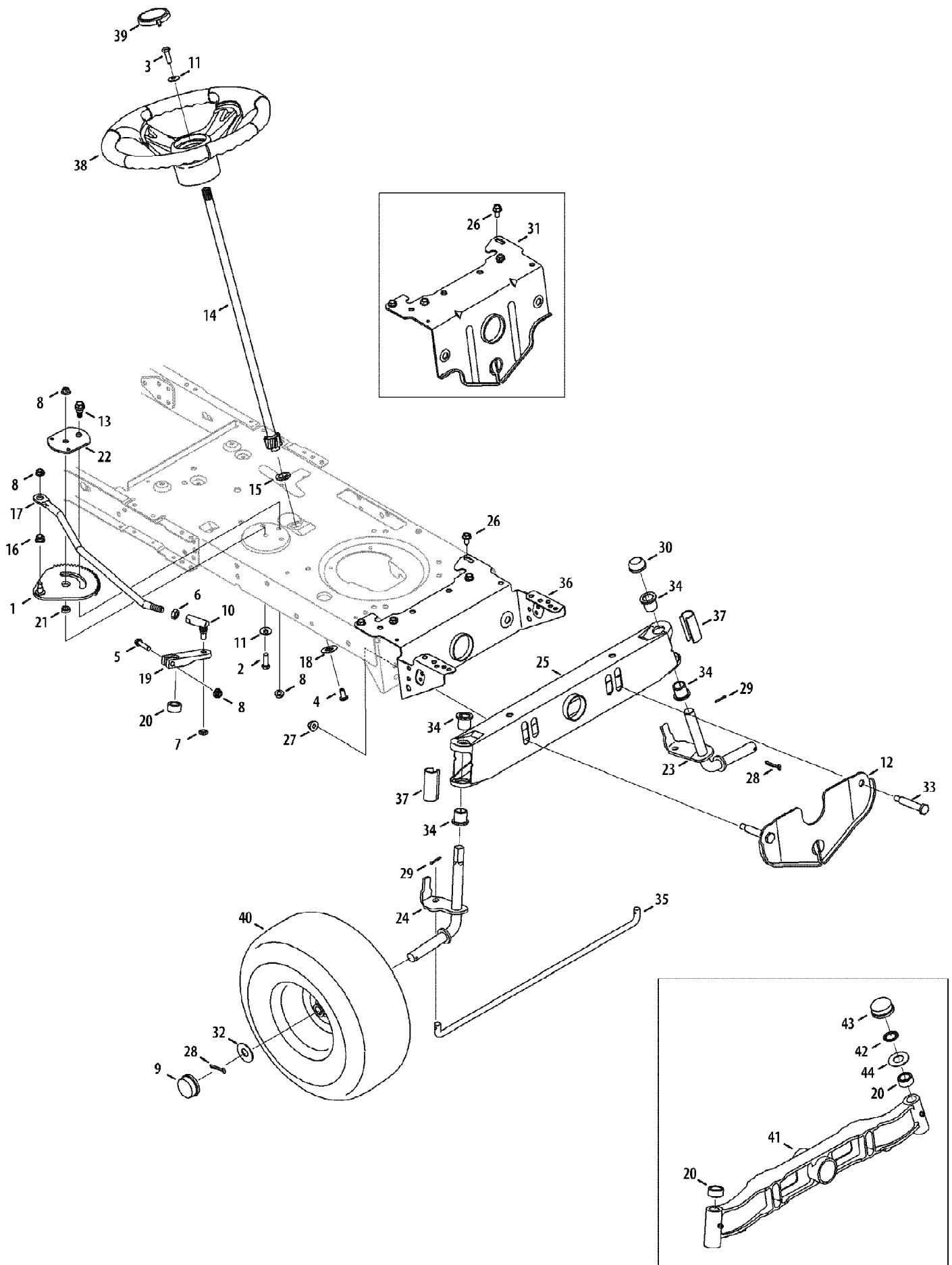

Ref #	Part Number	Qty	S/P/F	Description
1	617-04024	1	S	Gear Assembly, Steering
2	710-0376	1	/P	Screw, 5/16-18, 1.00, Gr5
3	710-0643	1	/P	Screw, 5/16-18, 1.00, Gr5, Lock
4	710-1309	1	/P	Screw, Mach, 5/16-18, 0.750
5	710-3180	1	/P	Screw, 5/16-18, 1.75, Gr5
6	712-0240	1	S	Nut, Jam, 7/16-20, Gr2
7	712-0262	1	/P	Nut, Jam Lock, 3/8-24, Gr2
8	712-04063	1	/P	Nut, Flange Lock, 5/16-18, Grf
9	731-0484A	1	S	Hub Cap
10	723-0448A	1	S	Ball Joint, 7/16-20, Lock
11	736-0242	1	/P	Washer, Bell, .340 x .872 x .060
12	783-04568	1		Front Hanger Bracket, Deck
13	738-04141	1		Shoulder Screw, .435 x .3485, 5/16-18
14	738-0919A	1	/P	Steering Shaft, 5/8 Spline x 21.86
15	741-04124	1	S	Bearing, Flange, Hex 5/8
16	741-0475	1	S	Plastic Bushing .380 ID
17	747-04298	1		Drag Link, Steering
18	748-0389	1	S	Cap, 1.25 x .16
19	748-04065	1	S	Steering, Block
20	748-04068	1		Spacer, .710 ID x .125 OD x .56
21	750-04418	1		Spacer, .322 ID x .625 OD x .21
22	783-04644	1	S	Stabilizer Plate, Gear Segment
23	638-04007	1	S	Axle Assmly LH (38" & 42" Deck)
24	638-04008	1	S	Axle Assmly RH (38" & 42" Deck)
25	683-0128B	1	/P	Pivot Bar
26	710-04484	1		Screw, 5/16-18, 0.750
27	712-04065	1	/P	Nut, Flange Lock, 3/8-16, GrF
28	714-04039	1		Pin, Cotter, 5/32, 1.25
29	714-0474	1	S	Pin, Cotter, 1/8 x 0.75
30	726-0341	1	/P	Push Cap, 3/4
31	783-05326	1	S	Pivot Bar Bracket, T-Style Hood
32	736-0316	1	S	Washer, Flat, .78 x 1.59 x .060
33	738-04128	1		Scr., Shlder, .500 x 2.380, 3/8-16
34	741-0660A	1	/P	Bearing, Flange, .760 x .941 x 1.0
35	747-04299A	1	/P	Tie Rod
36	783-04601C	1		Bracket, Pivot
37	731-04057A	1		Axle End Cap, Standard
38	631-04028	1		Steering Wheel, Standard Grip
38	631-04008A	1	/P	Steering Wheel, Soft Grip
39	731-04039	1		Cap, Steering Wheel (no logo)
39	731-04040	1		Cap, Steering Wheel (sprig logo)
39	731-04681	1		Cap, Steering Wheel (Troy-Bilt logo)
40	634-04325	1		Wheel Ass'y, Round Shoulder
40	734-04240A	1		Tire Only, 15 x 6 x 6, Round Shld. Not shown
40	634-04086	1		Wheel Ass'y, Square Shoulder Not shown
40	734-1731	1		Tire Only, 15 x 6 x 6, Square Shld. Not shown
40	634-04081	1	S	Rim Assembly (Incl. bearings & valve stem) Not shown
41	719-04177A	1		Pivot Bar, Cast
42	726-04035	1		Push Nut 3/4 Dia.
43	731-04693	1		Push Cap

13AN77KG011 Pony (2008)
Steering Assembly

Page 22 of 24

Ref #	Part Number	Qty	S/P/F	Description
44	736-0316	1	S	Washer, Flat, .78 x 1.59 x .60

13AN77KG011 Pony (2008)
Transmission

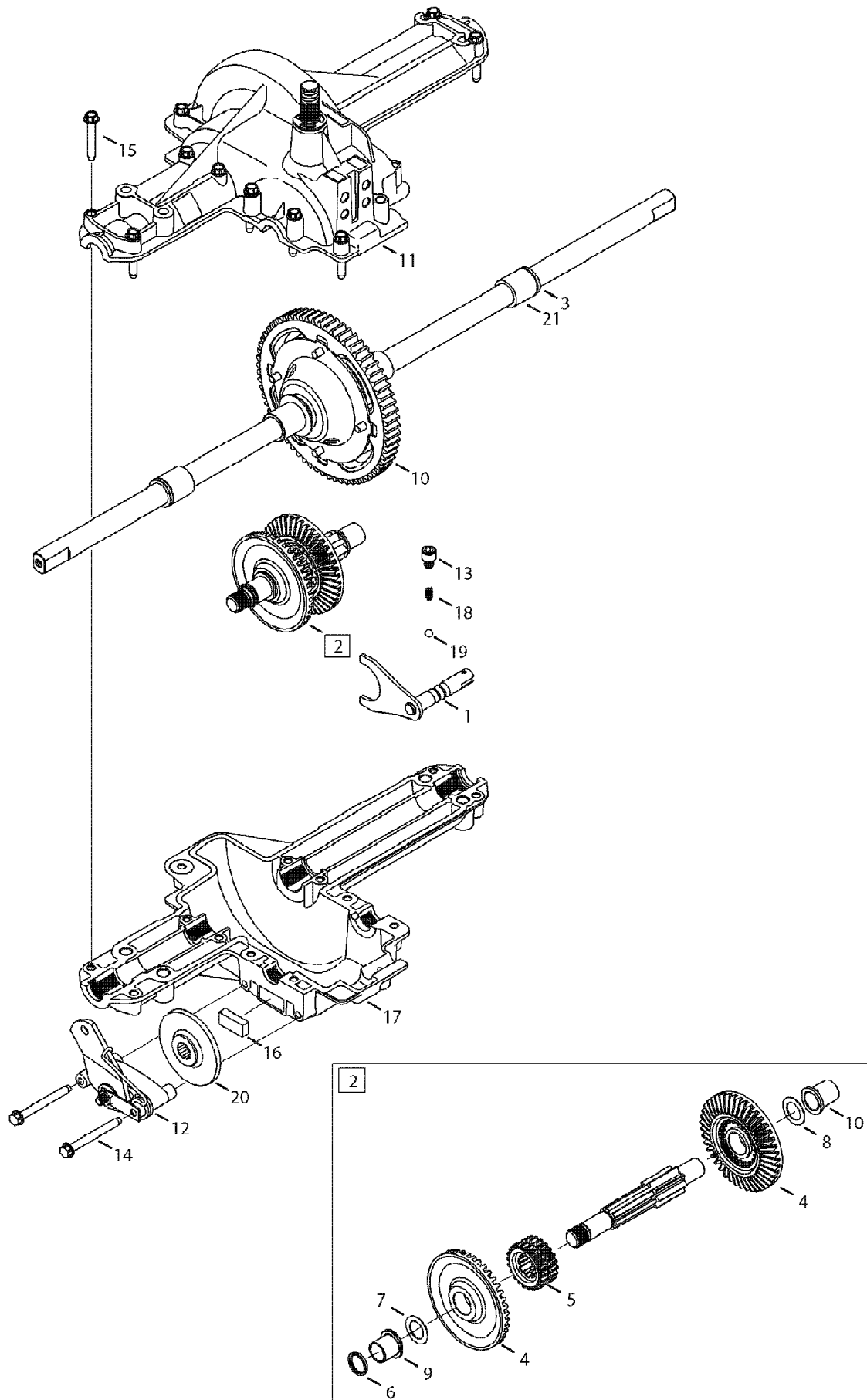

13AN77KG011 Pony (2008)
Transmission

Page 24 of 24

Ref #	Part Number	Qty	S/P/F	Description
1	611-0011	1	S	Detent Shaft Assembly
2	611-04091	1	S	Drive Shaft Assy. (includes ref. 3 - 9)
3	721-0338	1	S	Seal, .75 x 1.0 x .125
4	717-04479	1	S	Bevel Gear, 42 tooth spline
5	718-04381	1	S	Single Speed Clutch Collar
6	721-0213	1	/P	Seal, .625 x .812 x .094
7	736-0336	1	S	Flat Washer 5/8 x 1 x .030
7	736-0337	1	S	Flat Washer .634 x 1 x .04
7	736-0349	1	S	Flat Washer .63 x 1 x .02
7	736-0494	1		Flat Washer .632 x 1 x .035
7	736-0495	1	S	Thrust Washer 1.00 x .632 x .0
8	741-0336	1	S	Flange Bearing, 5/8 x 3/4 x 3/4
9	741-0337	1	S	Flange Bearing, 5/8 x 3/4 x 15/16
10	618-04567	1	S	Differential Assembly
11	619-04187	1	S	Upper Housing
12	661-0001	1	S	Brake Assembly
13	710-04731	1		Self-tapping Screw, 5/16-18 x .375
14	710-1206	1	/P	Self-tapping Screw, 1/4-20 x 2.375
15	710-1325	1	/P	Self-tapping Screw, 1/4-20 x 1.625
16	717-0678	1	S	Brake Puck
17	719-04329	1	S	Lower Housing
18	732-0863	1	S	Compression Spring
19	741-0862	1	/P	Detent Ball
20	761-0202	1		Brake Disc
21	741-0340	1	S	Sleeve Bearing, .75 x 1.0 x 1.0
	737-0148	1	S	Grease (19 oz.) Not Shown