

24AD597D711 LS33T Log Splitter (2010)  
General Assembly

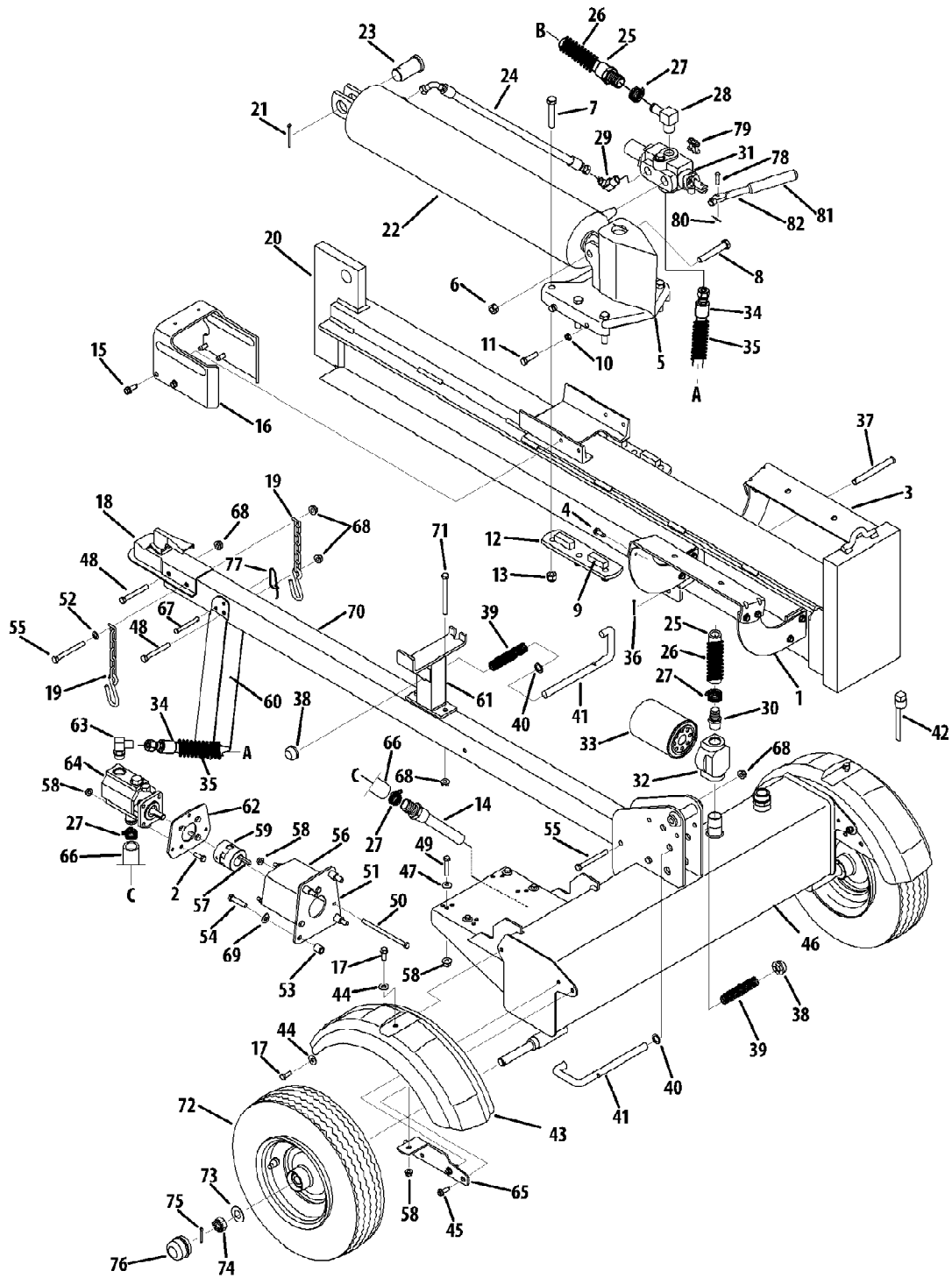

Ref #	Part Number	Qty	S/P/F	Description
1	781-04180-0637	1	/P	Log Tray Bracket
2	710-0376	1	/P	Hex Screw, 5/16-18 x 1.00
3	781-04179-0637	1	/P	Log Tray Bracket
4	710-04484	1		Self-Tapping Screw, 5/16-18 x .750
5	719-0550A	1	/P	Wedge Assembly
6	712-3022	1	/P	Lock Nut, 1/2-13
7	710-1018	1	/P	Hex Cap Screw, 1/2-20 x 2.75
8	710-1806	1	/P	Hex Cap Screw, 1/2-13 x 3.25
9	781-0351	1	/P	Adjustable Gib
10	712-0711	1	/P	Hex Jam Nut, 3/8-24
11	710-0459A	1	/P	Hex Cap Screw, 3/8-24 x 1.5
12	781-0790-0637	1	/P	Back Plate
13	912-3058	1		Hex Lock Nut, 1/2-20
14	737-04093	1		Inlet Filter
15	710-04683	1		Hex Washer Screw, 3/8-16 x 1.000
16	781-0525-0638	1		Dislodger
17	710-0650	1	/P	Self-Tapping Screw, 5/16-18 x .875
18	681-04030	1		Hitch Coupler, 2"
19	713-0433A	1	/P	Chain
20	981-04080	1	/P	Beam Assembly
21	714-0211	1		Cotter Pin
22	918-0313A	1	/P	Hydraulic Cylinder, 31/33 Ton
23	711-1135	1		Clevis Pin
24	727-04166	1		Hydraulic Hose
25	727-0443	1		Return Hose, 3/4" ID x 44"
26	781-0526A	1		Hose Guard
27	726-0132	1	/P	Hose Clamp, 5/8"
28	737-0153	1		Return Elbow
29	737-0192	1	/P	90 Degree Solid Male Adapter
30	737-0235	1		4" Hose Adapter
31	918-0481A	1	/P	Control Valve
32	737-0316	1	/P	Filter Housing
33	723-0405	1	/P	Oil Filter
34	727-0502	1		High Pressure Hydraulic Hose
35	781-0538A	1	/P	Hose Guard
36	914-0470	1	/P	Cotter Pin, 1/8"
37	738-0805	1		Hinge Pin, 1/2 x 4.8" Lg.
38	726-0214	1	/P	Push Cap
39	732-0583	1		Compression Spring, 4"
40	936-0116	1	/P	Flat Washer, .635 ID x .93 OD
41	781-0690	1		Locking Rod
42	737-0348A	1	/P	Vented Dipstick
43	731-2496A	1		Fender
44	736-0371	1	/P	Flat Washer, .343 x .880 x .062
45	710-0602	1	/P	Self-Tapping Screw, 5/16-18 x 1.00
46	981-04041B-0637	1	/P	Frame Assembly, 7.0 Gal
47	736-0242	1	/P	Bell Washer, 340 x .872 x .060
48	710-0521	1	/P	Hex Cap Screw, 3/8-16 x 3.00
49	710-3180	1	/P	Hex Cap Screw, 5/16-18 x 1.75
50	710-3226	1		Hex Cap Screw, 5/16-18 x 5.50
51	781-1100-0637	1	/P	Front Support Bracket Coupling
52	936-0185	1	/P	Flat Washer, .375 x .738 x .063
53	711-0396	1	/P	Spacer, .385 x .623 x .750

Ref #	Part Number	Qty	S/P/F	Description
54	710-0347	1	/P	Hex Cap Screw, 3/8-16 x 1.75
55	710-3085	1	/P	Hex Cap Screw, 3/8-16 x 3.50
56	719-0315	1		Coupling Shield
57	914-0114	1	/P	Key
58	712-04063	1	/P	Hex Flange Lock Nut, 5/16-18
59	718-04392	1		Coupling, .500
59	718-04393	1		Coupling, 1.00
59	735-04103	1		Spider Bushing
59	710-1842	1		Set Screw, 1/4-20 x .38
60	781-0162-0637	1	/P	Jack Stand
61	781-0398-0637	1		Support Beam Assembly
62	781-0097-0637	1	/P	Rear Coupling Support Bracket
63	737-0264	1		Adapter, 7/8-14
64	918-04128	1	/P	Pump
65	781-04174-0637	1	/P	Fender Mounting Bracket
66	727-0451	1		Suction Hose
67	911-0813	1	/P	Clevis Pin, 5/16 x 2.5
68	712-04065	1	/P	Flange Lock Nut, 3/8-16
69	936-0169	1	/P	Lock Washer, 3/8
70	781-0680B-0638	1	/P	Tube
71	710-0411	1	/P	Hex Cap Screw, 3/8-16 x 4.0
72	634-0186	1	/P	Wheel Assembly
72	934-0180-0662	1	S	Wheel/Rim Ass., 16.0 x 4.8 x 8.0
72	921-0168	1	/P	Dust Seal
72	941-0987	1	/P	Bearing, .75
73	936-0351	1	/P	Flat Washer, .76" ID x 1.5" OD
74	712-0359	1	/P	Slotted Nut, 3/4-16
75	714-0162	1	/P	Cotter Pin, 5/32" x 1-1/4"
76	734-0873	1		Hub Cap
77	732-0194	1		Spring Pin
78	711-04585	1		Clevis Pin
79	913-04036	1	/P	Valve Handle Link
80	914-0111	1	/P	Cotter Pin
81	720-04088	1	/P	Grip
82	747-04539	1		Hydraulic Valve Control

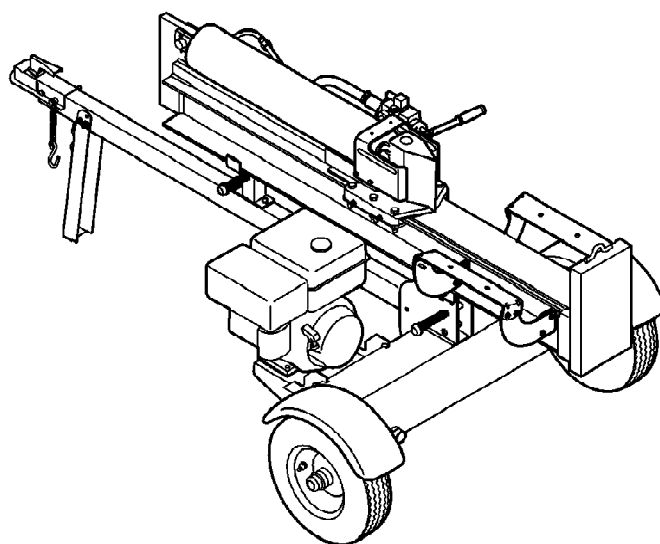

Ref #	Part Number	Qty	S/P/F	Description
	490-250-0009	1		Spark Plug
	N/A	1		Pre Filter
	17211-ZL8-023	1		Air Filter
	N/A	1		Fuel Filter
	918-04713	1	/P	Hydraulic Cylinder
	723-0405	1	/P	Hydraulic Filter
	737-04308	1		Inlet Filter
	737-0348A	1	/P	Vented Dipstick
	718-04392	1		Flexible Coupling .500
	718-04395	1		Flexible Coupling
	735-04103	1		Spider Bushing
	N/A	1		Adjustable Gibbs
	N/A	1		Belt
	747-04539	1		Hydraulic Valve Control
	720-04088	1	/P	Grip
	913-04036	1	/P	Valve Handle Link
	713-0433A	1	/P	Chain
	734-0873	1		Hub Cap
	634-0186	1	/P	Wheel Assembly