

21C-644D266 Bronco CRT Roto-Tiller (2010)
Drive System

Page 2 of 10

Ref #	Part Number	Qty	S/P/F	Description
1	684-04168	1		Idler Pulley Assembly, 1.917 OD
2	710-0170	1		Hex Head Screw, 5/16-24 x .625
3	710-0331	1	/P	Hex Head Screw, 3/8-24 x 2.25, B&S
3	710-0151	1	/P	Hex Head Screw, 3/8-24 x 2.00, Honda
4	710-0502A	1	/P	Screw, 3/8-16 x 1.250
5	710-0599	1	/P	Screw, 1/4-20 x 0.500
6	710-0606	1	/P	Hex Head Screw, 1/4-20 x 1.50
7	710-0672	1	/P	Hex Head Screw, 5/16-24 x 1.25
8	710-0805	1	/P	Hex Head Screw, 5/16-18 x 1.50
9	710-1880	1		Hex Head Screw, 5/16-18 x .75, Patch
10	736-0315	1	/P	Washer, Flat, .760 x 1.50 x .120
11	712-04063	1	/P	Flangelock Nut, 5/16-18
12	712-04064	1	/P	Flangelock Nut, 1/4-20
13	712-0700	1	/P	Flange Nut, 9/16-18
14	718-04407	1		Pulley Hub, 5/8 SPLINE
15	732-04085	1	/P	Extension Spring, .480 OD x 5.00 LG
16	732-04276A	1	/P	Extension Spring, LT5 PTO
17	936-0119	1	/P	Washer, Lock, 5/16
18	736-0173	1	/P	Washer, Flat, .28 x .74 x .063
19	736-0343	1	/P	Washer, Flat, .330 x 1.25 x .120
20	736-04193	1	/P	Washer, Belleville, .396 x 1.140 x .095
21	936-0452	1	/P	Washer, Bell, .396 x 1.140 x .095
22	736-3092	1	/P	Washer, Flat, .265 x 1.0 x .030
23	918-04816	1	S	Transmission Assembly
23	753-06042	1	S	Service Transmission Kit (Incl. Ref No. 13, 14, 23 & 31)
24	738-04425	1		Screw, Shoulder, 1/4-28 x .342 x .335
25	748-04087A	1	/P	Forward Idler Pivot Spacer
26	750-04571	1		Spacer, Shoulder, .260 x .785 x .538
27	750-04907	1		Reverse Idler Pivot Spacer
28	1916657	1	/P	V Belt, 4L x 25.375 LG
29	1916658	1	/P	V Belt, 3L x 29.125 LG Models with reverse
30	756-04198A	1		Engine Pulley, 3L & 4L & Honda
31	756-04355	1		Transmission Pulley
32	756-0625	1		Cable Roller
33	786-04312	1		Forward Idler Bracket
34	786-04343-0638	1		Cover Mounting Plate
35	786-04346	1		Reverse Idler Bracket
36	786-04357-0638	1		Pulley Mounting Bracket
37	786-04419-0638	1	S	LH Mount Frame
38	786-04418-0638	1	S	RH Mount Frame
39	786-04371-0638	1		Pulley Shield
40	934-04232	1	/P	Wheel, 13 x 5 x 6 650 Model Series
40	934-04453	1	/P	Wheel Assembly, 11 x 4-4 640 Model Series
41	714-0143A	1		Klik Pin, .25 DIA x 1.56
42	721-04271	1		Oil Plug

21C-644D266 Bronco CRT Roto-Tiller (2010)
Handle, Tine & Shield

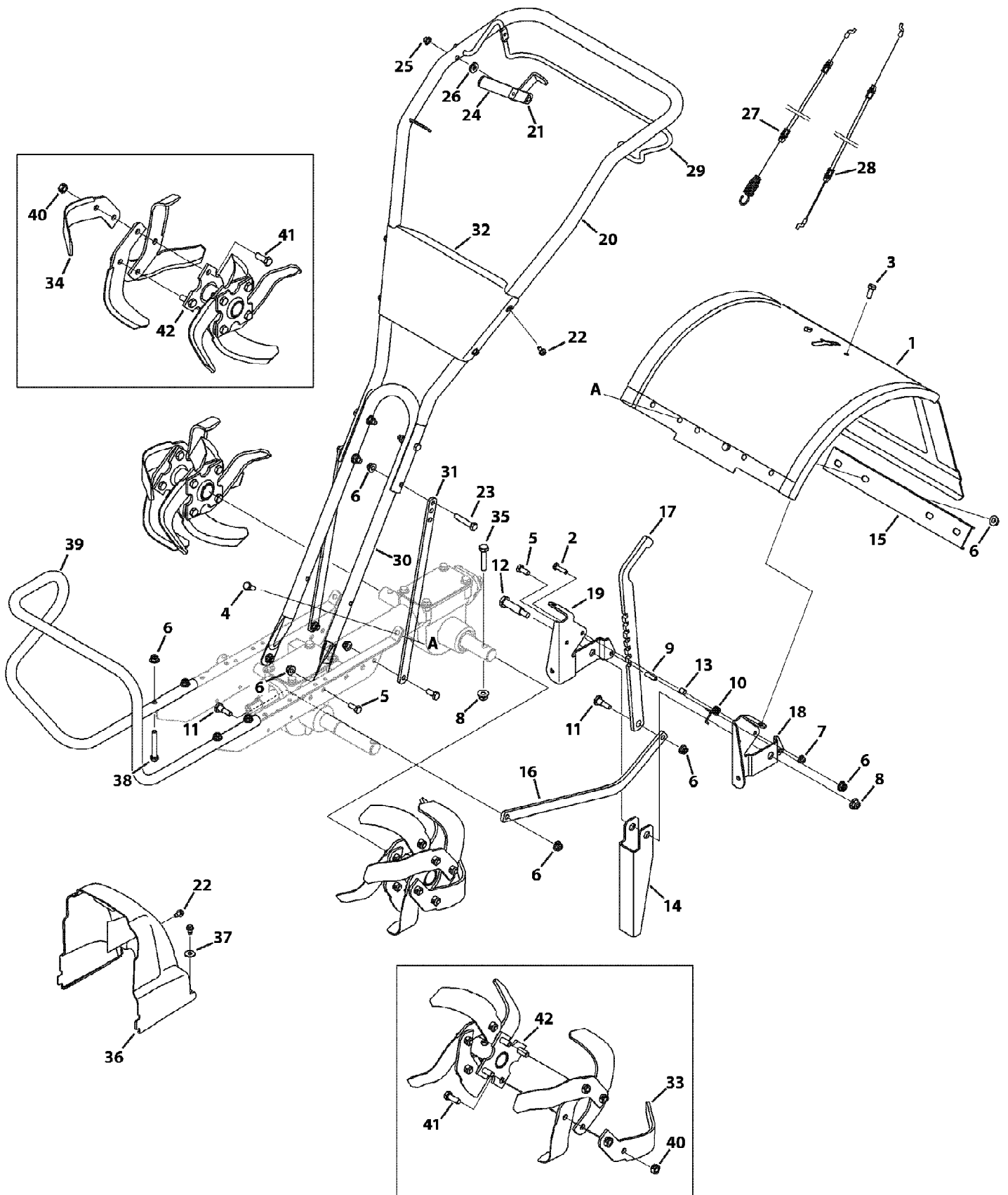

21C-644D266 Bronco CRT Roto-Tiller (2010)
Handle, Tine & Shield

Page 4 of 10

Ref #	Part Number	Qty	S/P/F	Description
1	686-04077-0638	1	/P	Tine Shield Assembly 650 Model Series
1	686-04076-0638	1	/P	Tine Shield Assembly 640 Model Series
2	710-0597	1	/P	Hex Head Screw, 1/4-20 x 1.00
3	710-0604A	1	/P	Screw, 5/16-18 x 0.625
4	710-1238	1	/P	Hex Head Washer, 5/16-18 x .875
5	710-3008	1	/P	Hex Head Screw, 5/16-18 x .75
6	712-04063	1	/P	Flangelock Nut, 5/16-18
7	712-04064	1	/P	Flangelock Nut, 1/4-20
8	712-04065	1	/P	Flangelock Nut, 3/8-16
9	715-0108	1	/P	Spring Pin, 1/4 DIA x 1.00 LG
10	732-04320	1	/P	Torsion Spring
11	738-04320	1		Screw, Shoulder, 5/16-18 x .405 x .435
12	938-0533	1	/P	Screw, Shoulder, \$r .498 x 1.635
13	750-05349	1		Spacer, Split, .350 x .268 x .375
14	786-04092-0638	1		Stop Reverse Arm
15	786-04098-0638	1		Support Channel Bracket
16	786-04104-0638	1	/P	Depth Drag Bar
17	786-04292-0638	1	/P	Depth Adjuster Bar
18	786-04363-0638	1		LH Tail Bracket
19	786-04364-0638	1		RH Tail Bracket
20	649-04066-0638	1	/P	Upper Handle Assembly
21	686-04098-0638	1		Reverse Handle Assembly 650 Model Series
22	710-0599	1	/P	Screw, 1/4-20 x 0.500
23	710-0805	1	/P	Hex Head Screw, 5/16-18 x 1.50
24	720-0270A	1		Reverse Handle Grip 650 Model Series
25	726-0135	1	/P	Speed Nut, Cap, .3125 DIA. 650 Model Series
26	936-3008	1	/P	Flat Washer, .344 x .750 x .120 650 Model Series
27	746-04413	1		Forward Cable
28	746-04414	1	S	Reverse Cable 650 Model Series
29	747-04789-0637	1	/P	Clutch Bail
30	749-04208-0638	1	/P	Lower Handle
31	786-04188-0638	1	/P	Support Handle Bracket
32	786-04200-0638	1	/P	Handle Panel
33	742-04226-0637	1	/P	LH Bolo Tine
34	742-04227-0637	1	/P	RH Bolo Tine
35	710-0347	1	/P	Hex Head Screw, 3/8-16 x 1.75
36	731-06170	1		Belt Cover
37	736-0173	1	/P	Washer, Flat, .28 x .74 x .063
38	710-0395	1	/P	Hex Head Screw, 5/16-18 x 2.25 650 Model Series
39	749-04193-0637	1	/P	Bumper 650 Model Series
40	912-3000	1	/P	Nut, Hexlock, 3/8-16
41	710-0514	1	/P	Hex Head Screw, 3/8-16 x 1.00
42	686-04065-0637	1	/P	Tine Holder Assembly 650 Model Series
42	686-04066-0638	1	/P	Tine Holder Assembly 640 Model Series

777I22441

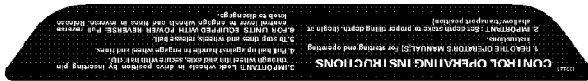

777I20937

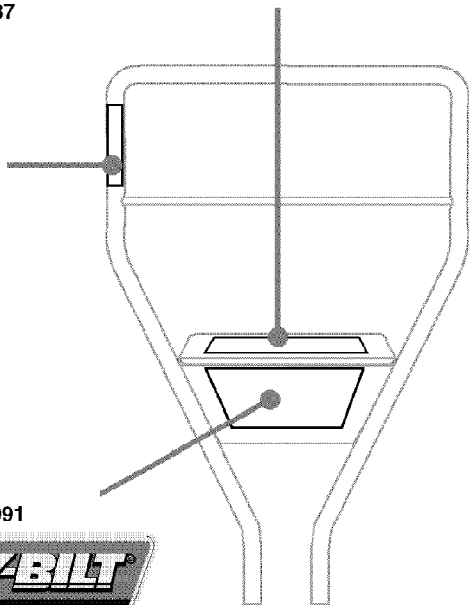

Model Plate

Tine Shield

777S33475

777I22616

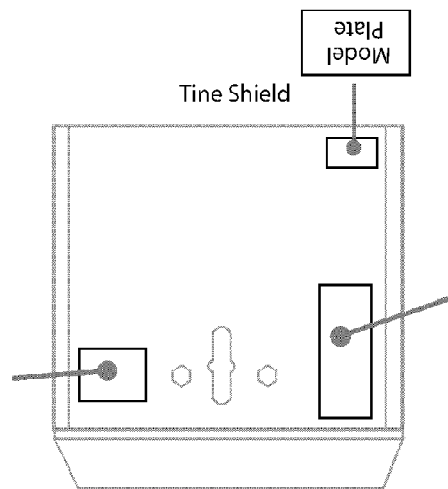
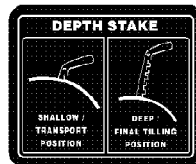

Operators Position

777D11091



777I20358
Place On Top Of
Fuel Tank



777X43688
Place Near Fuel Cap

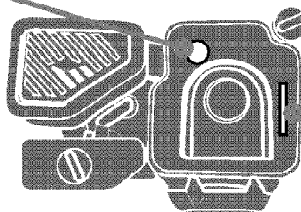

21C-644D266 Bronco CRT Roto-Tiller (2010)
Label Map Bronco

Page 6 of 10

Ref #	Part Number	Qty	S/P/F	Description
777I20937	777I20937	1		LABEL-BAIL CONTROL
777D11091	777D11091	1		LABEL-TILLER HANDLE BRONCO CRT
777X43688	777X43688	1		LABEL-ETHANOL
777I20358	777I20358	1		LABEL-PLACE HAND HERE
777I22616	777I22616	1		LABEL-TILLER TINE SHIELD DEPTH
777S33475	777S33475	1		LABEL-TLR:TN/SHLD:WRNG
777I22441	777I22441	1		LABEL-HNDL PNL INS

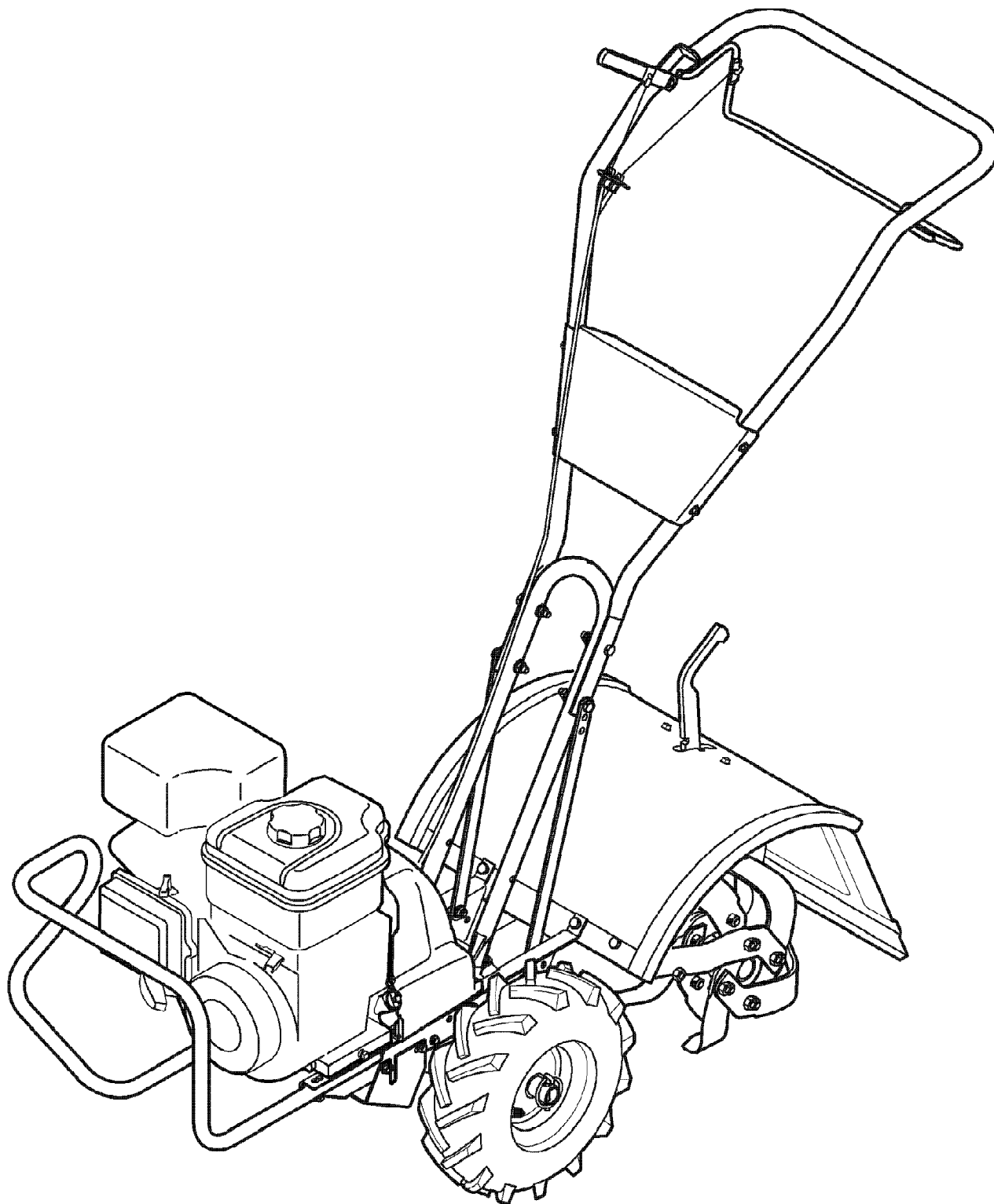

21C-644D266 Bronco CRT Roto-Tiller (2010)
Quick Reference

Page 8 of 10

Ref #	Part Number	Qty	S/P/F	Description
	759-3336	1	/P	Spark Plug - B&S
	490-250-0009	1		Spark Plug - Honda
	BS-493537S	1	/P	Pre Filter - B&S
	N/A	1		Pre Filter - Honda
	BS-491588S	1	/P	Air Filter - B&S
	17211-ZL8-023	1		Air Filter - Honda
	951-3013	1	S	Fuel Filter - B&S
	16910-ZV4-015	1		Fuel Filter - Honda
	BS-795221	1		Fuel Cap - B&S
	17620-Z0J-800	1		Fuel Cap - Honda
	1916657	1	/P	Drive Belt - FWD
	1916658	1	/P	Drive Belt - REV
	684-04168	1		Idler Pulley
	746-04413	1		Clutch Cable - FWD
	746-04414	1	S	Clutch Cable - REV
	742-04226-0637	1	/P	LH Bolo Tine
	742-04227-0637	1	/P	RH Bolo Tine
	934-04232	1	/P	Wheel, 13 x 5 x 6
	934-04453	1	/P	Wheel Assembly, 11 x 4-4
	N/A	1		Foam Grip
	N/A	1		Shift Control Knob
	N/A	1		Handle Knob

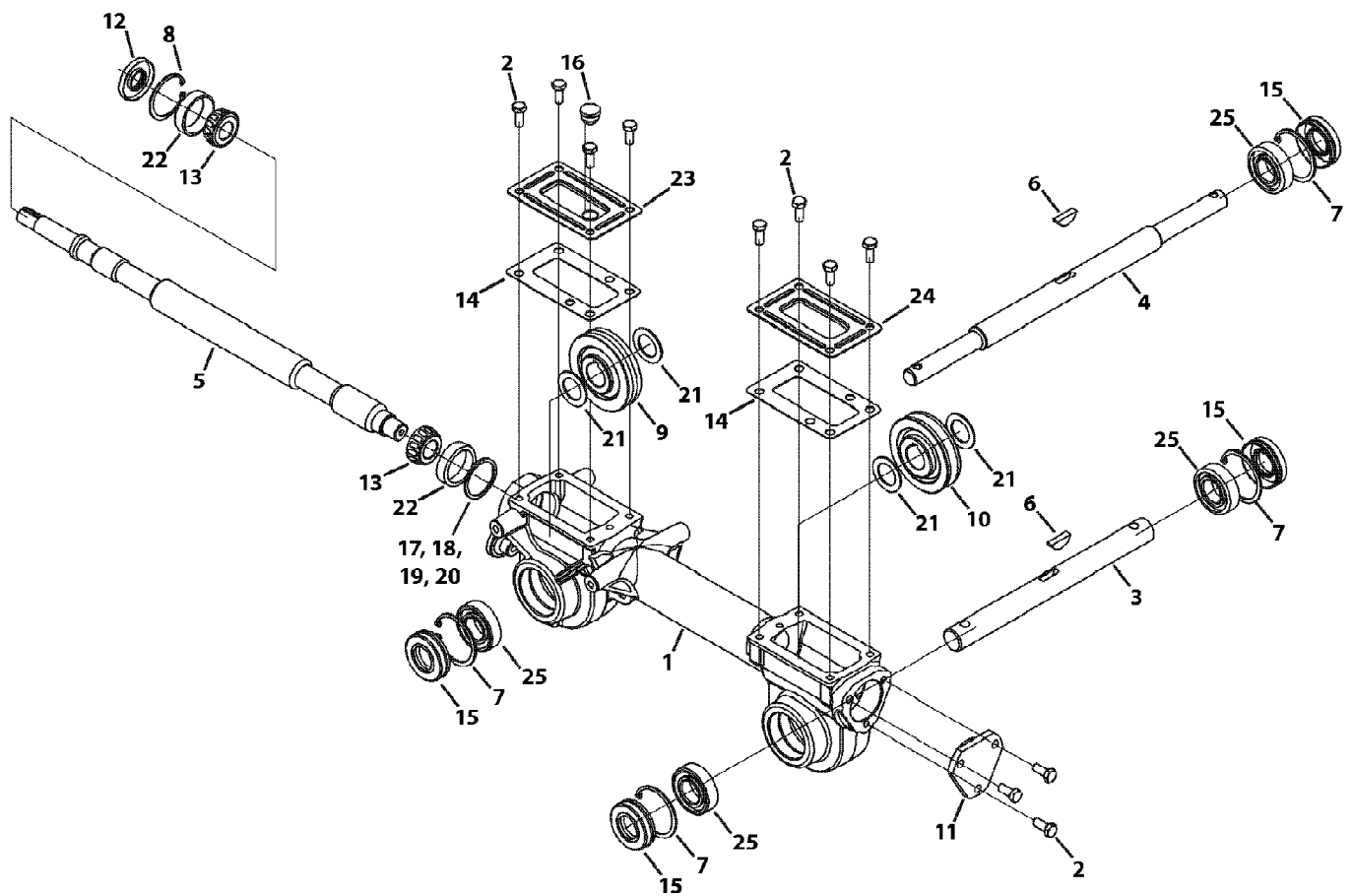

21C-644D266 Bronco CRT Roto-Tiller (2010)
Transmission

Page 10 of 10

Ref #	Part Number	Qty	S/P/F	Description
1	919-04202B	1	/P	Transmission Housing
2	710-3008	1	/P	Hex Head Screw, 5/16-18 x .75
3	911-04844	1	/P	Tiller Shaft
4	911-04854	1	/P	Wheel Shaft
5	711-05035	1		CRT Drive Shaft
6	714-04059	1	/P	Key, .25 x 1.062
7	716-0204	1		Retainer Ring
8	716-04102	1	/P	Retainer Ring
9	917-04380	1	/P	RH Gear Worm, 61T
10	917-04381	1	/P	LH Gear Worm, 30T
11	918-04435	1	/P	Bearing Cover
12	921-04030	1	/P	Oil Seal, .750 SHF x 1.783 BORE
13	941-04298	1	/P	Cone Bearing
14	921-04229	1	/P	Gear Housing Gasket
15	721-04232	1		Oil Seal, 1.00 SHF x 2.00 BORE
16	721-04271	1		Rubber Oil Plug
17	736-04305	1	/P	Washer, Flat, 1.50 x 1.75 x .062
18	736-04306	1	/P	Washer, Flat, 1.50 x 1.75 x .005
19	736-04307	1	/P	Washer, Flat, 1.50 x 1.75 x .03
20	736-04308	1	/P	Washer, Flat, 1.50 x 1.75 x .010
21	736-0745	1	/P	Washer, Flat, 1.010 x 1.56 x .060
22	941-04299	1	/P	Cup Bearing
23	786-04366	1		Tiller Transmission Cover
24	786-04392	1		Tiller Transmission Cover
25	741-3114	1		Ball Bearing, 1 x 52 x 15 x 6205-1