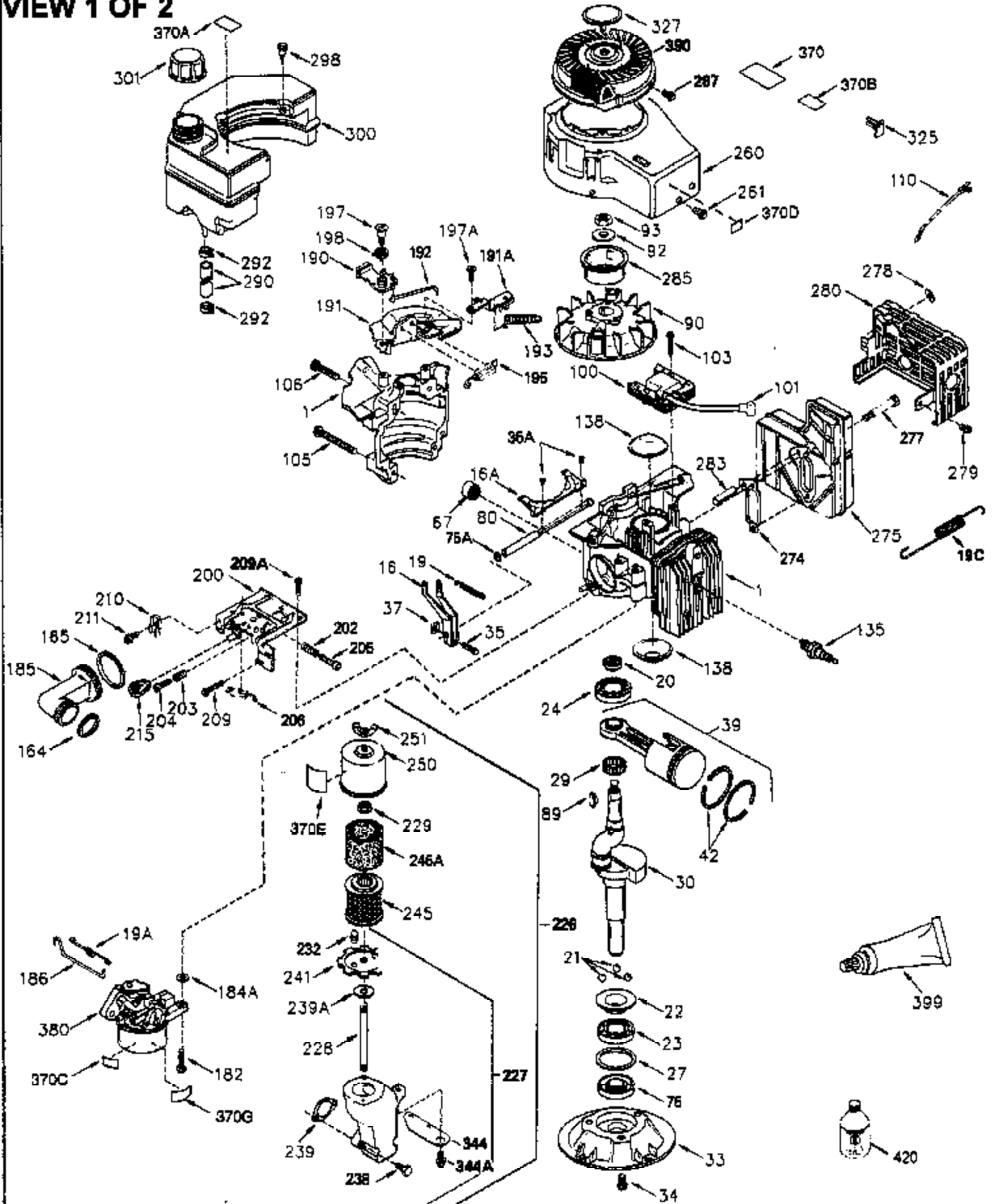

ILLUSTRATION SHOWS TYPICAL PARTS ONLY. ORDER BY PART NUMBER. PARTS NOT LISTED ARE SUPPLIED BY OEM.

VIEW 1 OF 2



Engine Parts List #1

Ref #	Part Number	Qty	Description
	1 250288	1	Cylinder (Incl. 67, 75A, 105, 106 & 1 38)
16A	490304	1	Governor Lever
16	490306	1	Governor Lever
19A	490307	1	Backlash Spring
19	490308	1	Extension Spring
20	510340	1	Oil Seal
21	570673	3	Ball Bearing
22	510338	1	Slide Ring
23	530158	1	Ball Bearing
24	530161	1	Ball Bearing
27	530159	1	Bearing Retainer
29	530164	1	Bearing Strip (31 Needles)
30	290641	1	Crankshaft
33	330179	1	Adapter Plate
34	792067	3	Screw, 5/16-18 x 1"
35A	650961	2	Screw, 4-40 x 1/4"
35	29826	1	Screw, 10-32 x 3/4"
37	29216	1	Lock Nut, 10-32
39	310279B	1	Piston & Rod Ass'y. (Incl. 29 & 42)
42	310239	2	Ring Set
67	430233	1	Fuel Filter
75	510339	1	Oil Seal
75A	510337	1	Oil Seal
80	490305	1	Governor Shaft
89	611107	1	Flywheel Key
90	611109	1	Flywheel
92	650815	1	Belleville Washer
93	650816	1	Flywheel Nut
100	34443A	1	Solid State Ignition
101	610118	1	Spark Plug Cover
103	650814	2	Screw, Torx T-15, 10-24 x 1"
105	650892	2	Screw, 5/16-18 x 2-3/16"
106	650891	2	Screw, 5/16-18 x 1-5/8"
110	611106	1	Ground Wire
135	35395	1	Resistor Spark Plug (RJ19LM)
138	570683	2	Port Cover
164	510341	1	"O" Ring
165	510342	1	"O" Ring
182	792067	2	Screw, 5/16-18 x 1"
184A	27110	2	Washer
185	570674	1	Intake Pipe (Incl. 164 & 165)
186	490309	1	Governor Link
190	570688	1	Brake Lever
191	570677	1	Brake Bracket Ass'y.
191A	570678A	1	Brake Control Lever
192	490312	1	Brake Control Link
193	490311	1	Brake Spring
195	610973	1	Terminal
197	650896	1	Screw, 1/4-20 x 13/16"
197A	650897	1	Screw, 1/4-20 x 13/32"
198	490313	1	Brake Control Lever Spring
200	570675A	1	Control Bracket (Incl. 202 thru 206)
202	32924	1	Compression Spring
203	31342	1	Compression Spring
204	650549	1	Screw, 5-40 x 7/16"
205	650606	1	Screw, 10-32 x 1-1/8"
206	610973	1	Terminal
209A	650867	2	Screw, 10-24 x 1/2"

Ref #	Part Number	Qty	Description
209	650735	1	Screw, 10-24 x 3/8"
210	27793	1	Conduit Clip
211	650837	1	Screw, 10-32 x 1/4"
226	730575A	1	Air Cleaner Kit (Incl. items marked # # sign)
227	450249A	1	## A/C Elbow (Incl. items marked with # sign)
228	650901	1	# Stud, 1/4-20 x 4.89"
232	xxxxx	2	# Pop Rivet (Can be purchased locally)
238	650940	2	## Screw, 10-32 x 3/4"
239	35815	1	## Air Cleaner Gasket
239A	34698A	1	# Air Cleaner Gasket
241	34699	1	# Air Cleaner Collar
245	34782	1	## Air Cleaner Filter
250	34781	1	## Air Cleaner Cover
251	650513	1	## Wing Nut, 1/4-20
260	350430	1	Blower Housing
261	650894	4	Screw, 5/16-18 x 5/8"
274	510343A	1	Exhaust Gasket
275	390316	1	Muffler
277	650893	2	Screw, 5/16-18 x 3-13/64"
283	390315	1	E.G.R. Tube
285	34449A	1	Starter Cup
287	650926	4	Screw, 8-32 x 21/64"
290	29774	1	Fuel Line
292	26460	2	Fuel Line Clamp
298	650895	3	Screw, 10-32 x 5/8"
300	410258	1	Fuel Tank
301	410259A	1	Fuel Cap
325	29443	1	Wire Clip
327	35392	1	Starter Plug
344	450256	1	# Air Cleaner Brace
344A	650894	1	# Screw, 5/16-18 x 5/8"
370	550234	1	Bowl Nut Decal
370A	36261	1	Lubrication Decal
380	632434	1	Carburetor (Incl. 164)
390	590694	1	Rewind Starter (NOTE: This engine could have been built with 590686 starter. Refer to the design of the air intake louvers for part identification. Individual starter parts do not interchange.)
399	510334	1	Gasket Eliminator (Loctite 515)
420	730227A	1	2-Cycle Oil (8 oz.)

ILLUSTRATION SHOWS TYPICAL PARTS ONLY. ORDER BY PART NUMBER. PARTS NOT LISTED ARE SUPPLIED BY OEM.

VIEW 2 OF 2

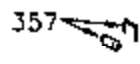
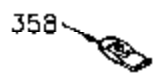
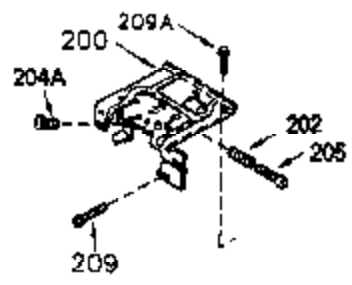
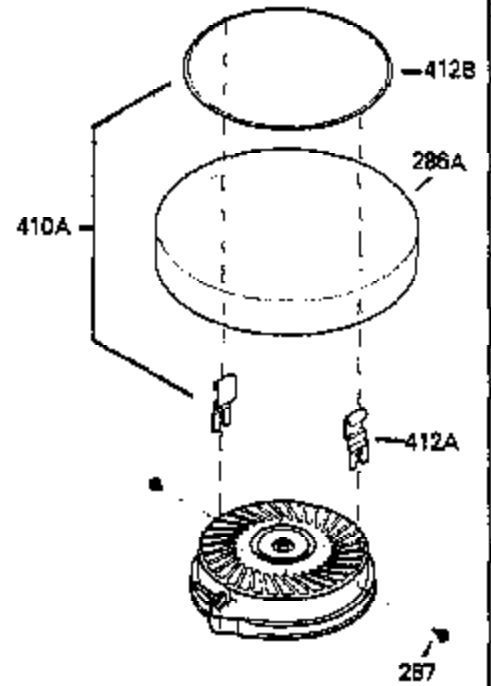
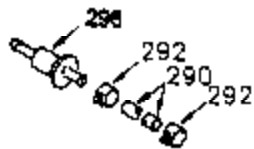
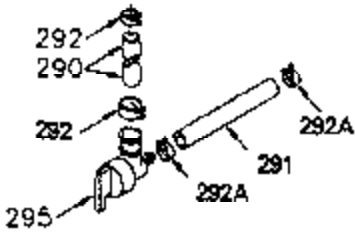

Ref #	Part Number	Qty	Description
200	570675A	1	Control Bracket (Incl. 202 thru 206)
202	32924	1	Compression Spring
205	650606	1	Screw, 10-32 x 1-1/8"
209A	650867	2	Screw, 10-24 x 1/2"
209	650735	1	Screw, 10-24 x 3/8"
245	34782	1	## Air Cleaner Filter
287	650926	4	Screw, 8-32 x 21/64"
290	29774	1	Fuel Line
292	26460	2	Fuel Line Clamp
390	590694	1	Rewind Starter (NOTE: This engine could have been built with 590686 starter. Refer to the design of the air intake louvers for part identification. Individual starter parts do not interchange.)