

VIEW 1 OF 3

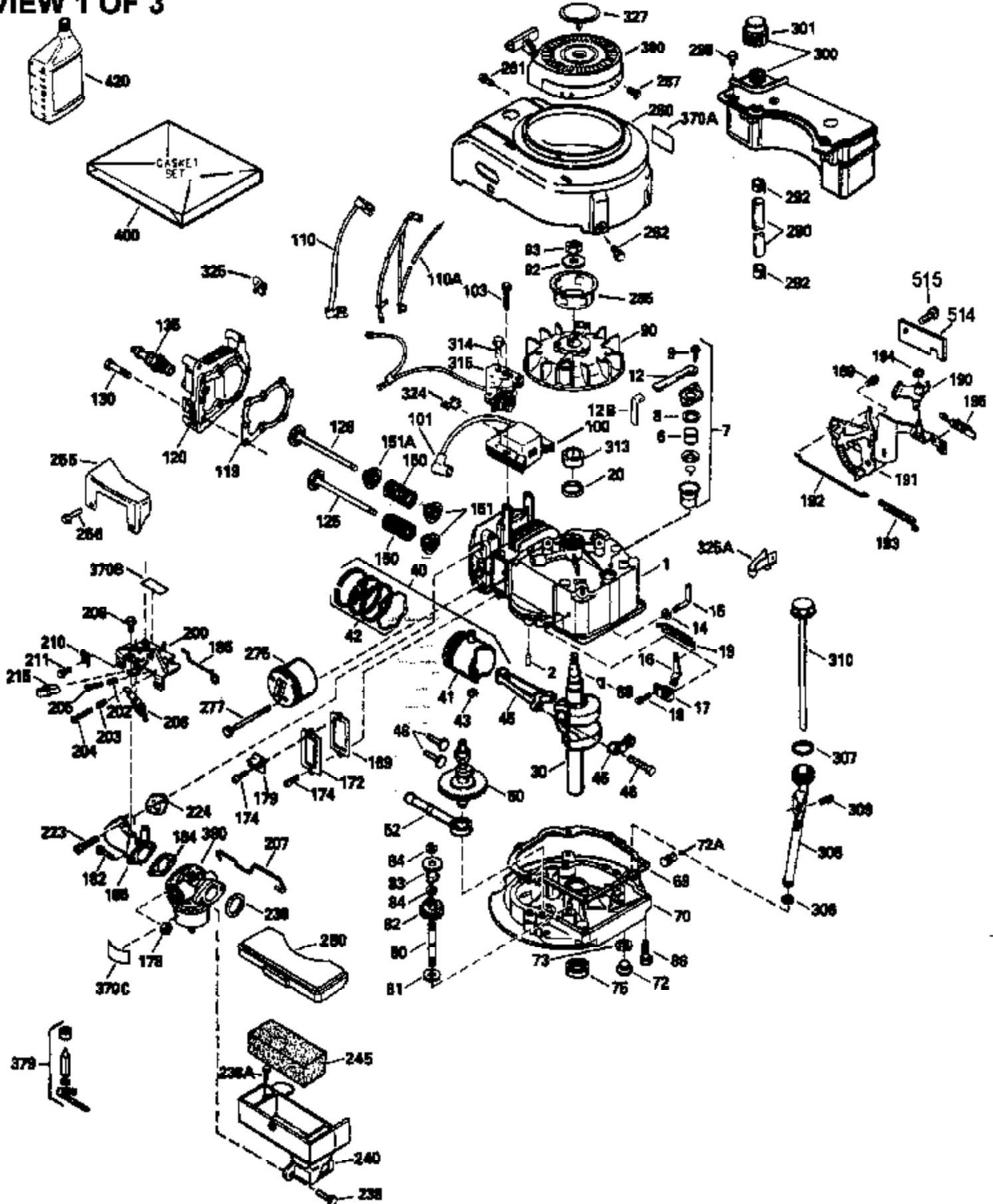

Ref #	Part Number	Qty	Description
1	33968B		Cylinder (Incl. 2 & 20) (2-13/16")
2	26727		Pin, Dowel
6	33734		Element, Breather
7	34214A		Breather Ass'y. (Incl. 6, 8, 9, 12 , & 12A)
8	33735		* Gasket, Breather
9	30200		Screw, 10-24 x 9/16"
12	33886		Tube, Breather
14	28277		Washer, Flat
15	30589		Rod, Governor (Incl. 14)
16	31383A		Lever, Governor
17	31335		Clamp, Governor lever
18	650548		Screw, 8-32 x 5/16"
19	31361		Spring, Extension
20	32600		Seal, Oil
30	34566		Crankshaft
32	32323		Washer, Thrust NOTE: This thrust washer maynot be required if a new crankshafthas been installed. Check the proper Mechanic's Handbook for acceptable end play. Use this .010" thrust washer if excess end play is measured.
40	34535		Piston, Pin & Ring Set (Std.) (2-13/16")
40	34536		Piston, Pin & Ring Set (.010" OS)
40	34537		Piston, Pin & Ring Set (.020" OS)
41	33562B		Piston & Pin Ass'y.(Incl. 43)(Std.)(2 -13/16")
41	33563B		Piston & Pin Ass'y. (Incl. 43) (.010" OS)
41	33564B		Piston & Pin Ass'y. (Incl. 43) (.020" OS)
42	33567		Ring Set (Std.) (2-13/16" Bore)
42	33568		Ring Set (.010" OS)
42	33569		Ring Set (.020" OS)
43	20381		Ring, Piston pin retaining
45	32875		Rod Assy., Connecting (Incl. 46)
46	32610A		Bolt, Connecting rod
48	27241		Lifter, Valve
50	33553		Camshaft (MCR)
52	29914		Oil Pump Assy.
69	35261		* Gasket, Mounting flange
70	34311C		Flange Ass'y. (Incl. 72, 72A, 73, 75 & 80)
72	30572		Plug, Oil drain (Incl. 73)
73	28833		* Drain Plug Gasket (Not req. W/plastic plug)
75	27897		Seal, Oil
80	30574		Shaft, Governor
81	30590A		Washer, Flat
82	30591		Gear Assy., Governor (Incl. 81)
83	30588A		Spool, Governor
84	29193		Ring, Retaining
86	650488		Screw, 1/4-20 x 1-1/4"
89	611004		Flywheel Key
90	611046A		Flywheel
92	650815		Washer, Belleville
93	650816		Nut, Flywheel
100	34443A		Solid State Ignition
100	730207		Magneto-to-Solid State Conv. Kit (Includes solid state module, solid state flywheel key, and instructions.) (Use as required on external ignition engines only.)
101	610118		Cover, Spark plug (Use as required)
103	650814		Screw, Torx T-15, 10-24 x 1"
110	34231		Ground Wire
118	730194		Rope Guide Kit (Use as required)

Ref #	Part Number	Qty	Description
119	33554A		* Gasket, Head
120	34342		Head, Cylinder
125	29314B		Intake Valve (Std.) (Incl. 151) (Conventional Ports)
125	29315C		Intake Valve (1/32" OS) (Incl. 151) (Conventional Ports)
125	29313C		Exhaust Valve (Std.) (Incl. 151) (Inverted Ports)
126	29313C		Exhaust Valve (Std.) (Incl. 151) (Conventional Ports)
126	29315C		Exhaust Valve (1/32" OS) (Incl. 151) (Conventional Ports)
126	34776		Exhaust Valve (Std.) (Incl. 151) (Conventional Ports)
126	32644A		Intake Valve (Incl. 151) (Inverted Ports)
130	6021A		Screw, 5/16-18 x 1-1/2" (Use as required)
130	650697A		Screw, 5/16-18 x 2-1/2" (Use as required)
135	35395		Resistor Spark Plug (RJ19LM)
150	31672		Spring, Valve
151	31673		Cap, Lower valve spring
169	27234A		Gasket, Valve spring box cover
172	32755		Cover, Valve spring box
174	650128		Screw, 10-24 x 1/2"
178	29752		Nut & Lockwasher, 1/4-28
182	6201		Screw, 1/4-28 x 7/8"
184	26756		* Gasket, Carburetor
186	34337		Link, Governor spring
200	33131A		Control Bracket (Incl. 202 thru 206)
202	33802		Spring, Compression
203	31342		Spring, Compression
204	650549		Screw, 5-40 x 7/16"
205	650777		Screw, 6-32 x 21/32"
206	610973		Terminal (Use as required)
207	34336		Link, Throttle
209	30200		Screw, 10-24 x 9/16"
210	27793		Clip, Conduit
211	28942		Screw, 10-32 x 3/8"
223	650451		Screw, 1/4-20 x 1"
224	34690A		* Gasket, Intake pipe
238	650806		Screw, 10-32 x 5/8"
239	34338		* Gasket, Air cleaner
240	34858		Body, Air cleaner
246E	35435		Filter, Pre-air (Use as required)
246	34340		Element, Air cleaner
250	34341A		Cover, Air cleaner
261	30200		Screw, 10-24 x 9/16"
262	650831		Screw, 1/4-20 x 15/32"
277	650795		Screw, 1/4-20 x 2-1/4" (Use as required)
277	650774		Screw, 1/4-20 x 2-3/8" (Use as required)
277	792005		Screw, 1/4-20 x 2-1/2" (Use as required)
285	34449		Hub, Starter
286	35009		Screen, Starter cup
290	34357		Fuel Line (Epichlorohydrin 6-3/4")(17 cm)
290	29774		Fuel Line(Braided 8-1/4")(21 cm)(Use as req.)
290	30705		Fuel Line (Braided 16")(40 cm)(Use as req.)
290	30962		Fuel Line (Braided 32")(81 cm)(Use as req.)
292	26460		Clamp, Fuel line
298	28763		Screw, 10-32 x 35/64"
301	33032		Fuel Cap (Use as required)
305	34264		Oil Fill Tube
306	34265		Gasket, Oil fill tube

Ref #	Part Number	Qty	Description
306	34282		"O" Ring (This "O" ring is required with metal fill tube only when replacement mounting flange with .777 dia. oil fill hole has been used.)
307	33590		"O" Ring
309	650562		Screw, 10-32 x 1/2"
310	34267		Oil Dipstick (Incl. 150)
313	34080		Spacer, Flywheel key
370J	34870		Decal, Instruction (Optional)
370A	34346		Decal, Instruction
370H	34387		Decal, Instruction (Optional)
379	631021		Inlet Needle, Seat & Clip Assy.
380	632099		Carburetor (Incl. 184) (Refer to Division 5, Section A, page A2-6 or Fiche 8A, Grid E-9for breakdown)
390	590420A		Rewind Starter (Refer to Division 5, Section C, page 25 or Fiche 8A, Grid G-4 for breakdown)
400	33740D		* Gasket Set (Incl. items marked *)
420	730225		SAE 30, 4-Cycle Engine Oil (Quart)
425	730571		Starter Muff Kit (Incl.370J,426,427)(Opt.)
426	32203		Starter Air Cleaner (Optional)
427	32204		Starter Air Cleaner Bracket (Optional)
436	611006		Stator Plate Ass'y.(Incl.377,378,437, 442-448)
437	30551		Spring, Breaker box cover
438	610947		Cover, Dust
439	610955		Gasket, Stator cover
440	30992		Cam, Breaker
442	610385		Washer
443	610408		Nut, 8-32
444	29181		Breaker Fastening Screw & Washer
445	610593		Condenser Fastening Screw
446	33356		Terminal, Ground

VIEW 2 OF 3

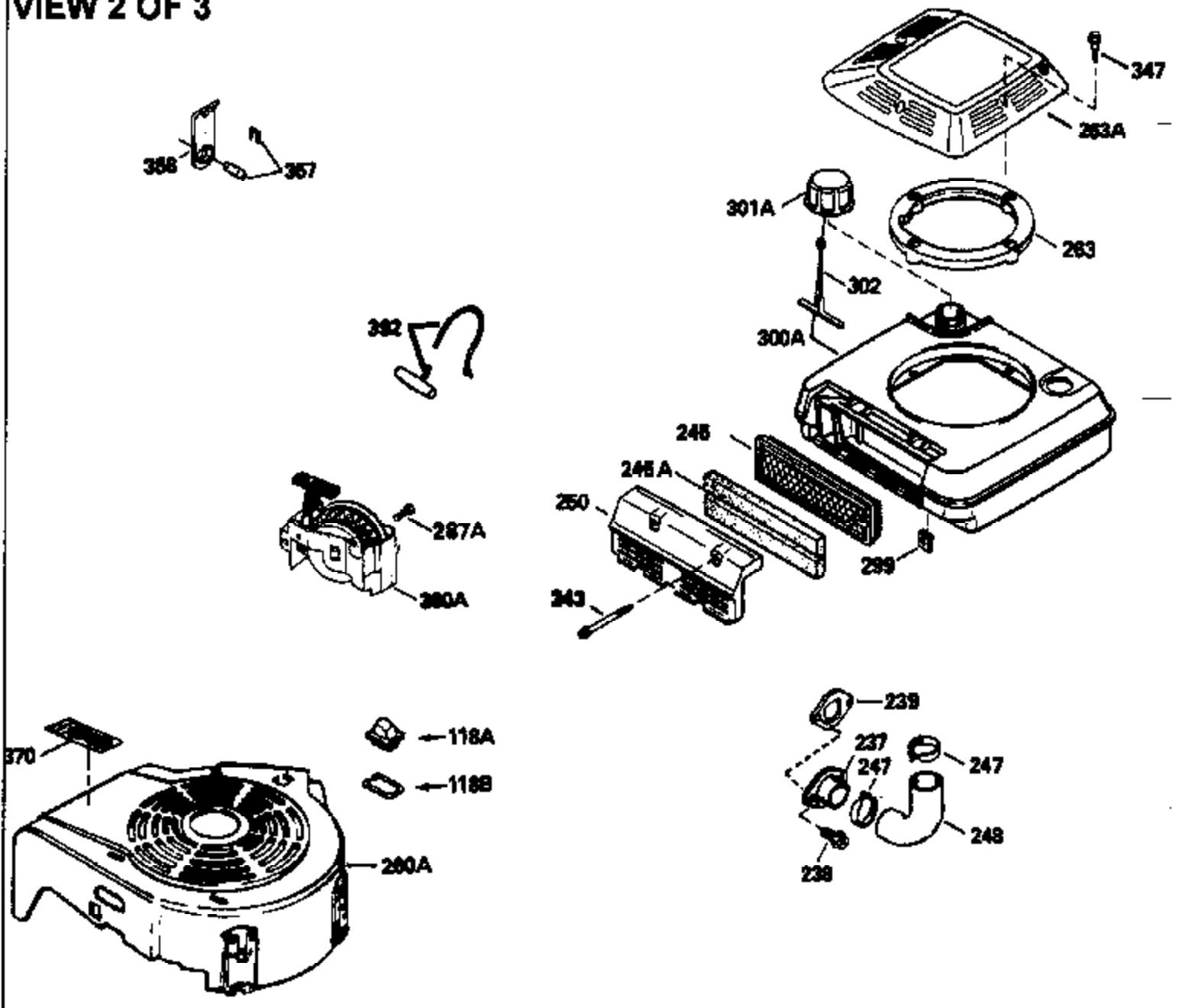

Ref #	Part Number	Qty	Description
32	32323		Washer, Thrust NOTE: This thrust washer maynot be required if a new crankshafthas been installed. Check the proper Mechanic's Handbook for acceptable end play. Use this .010" thrust washer if excess end play is measured.
118	730194		Rope Guide Kit (Use as required)
238	650806		Screw, 10-32 x 5/8"
239	34338		* Gasket, Air cleaner
246	34340		Element, Air cleaner
246E	35435		Filter, Pre-air (Use as required)
250	34341A		Cover, Air cleaner
260A	34936		Housing, Blower
286	35009		Screen, Starter cup
287A	650735		Screw, 10-24 x 3/8" (Use as required)
287A			Pop Rivet (3/16" Dia.) (Purchase loca lly)
300A	34476		Fuel Tank (Incl. 292 & 301)
370J	34870		Decal, Instruction (Optional)
370	550223		Decal, Name
370H	34387		Decal, Instruction (Optional)
425	730571		Starter Muff Kit (Incl.370J,426,427)(Opt.)
426	32203		Starter Air Cleaner (Optional)
427	32204		Starter Air Cleaner Bracket (Optional)
436	611006		Stator Plate Ass'y.(Incl.377,378,437, 442-448)
437	30551		Spring, Breaker box cover
438	610947		Cover, Dust
439	610955		Gasket, Stator cover
440	30992		Cam, Breaker
442	610385		Washer
443	610408		Nut, 8-32
444	29181		Breaker Fastening Screw & Washer
445	610593		Condenser Fastening Screw
446	33356		Terminal, Ground

VIEW 3 OF 3

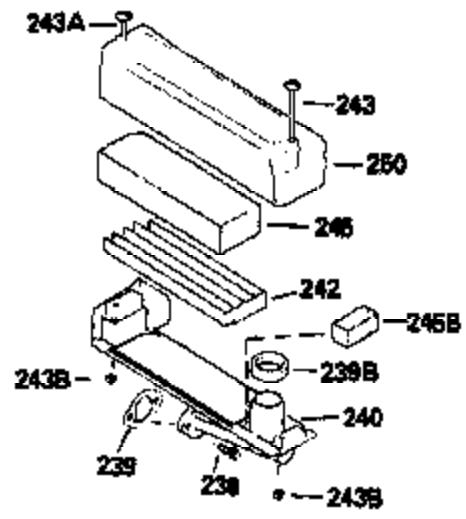
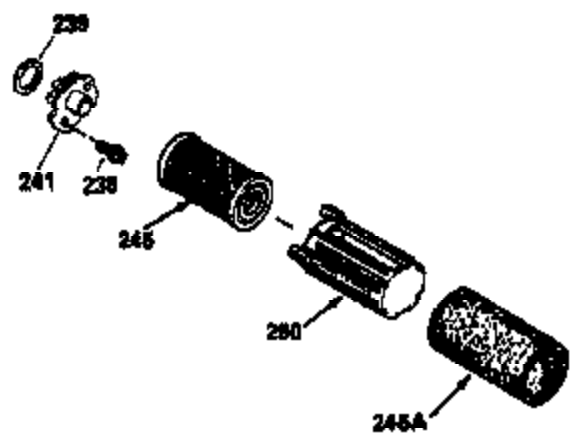
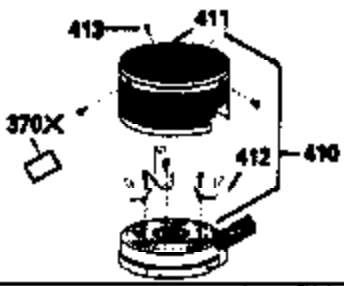
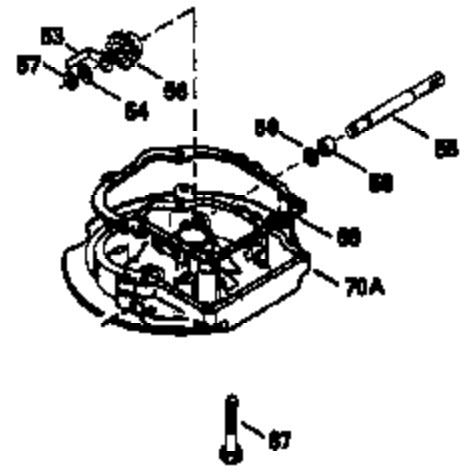
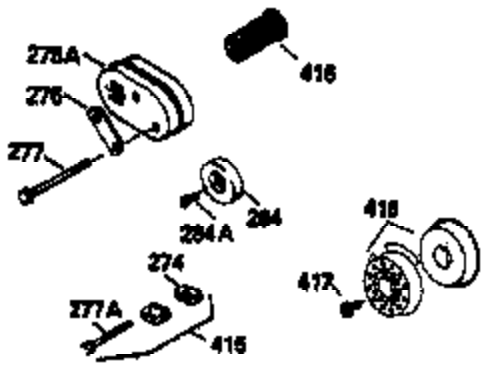
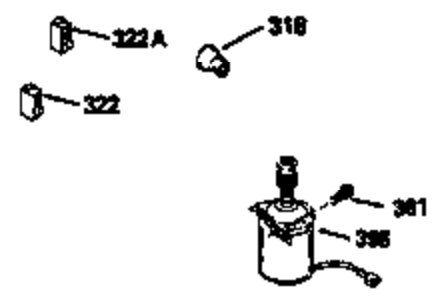
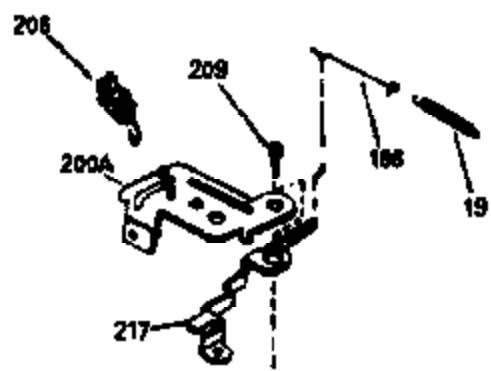
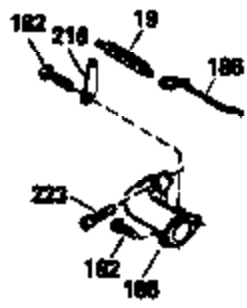

Ref #	Part Number	Qty	Description
19	31361		Spring, Extension
32	32323		Washer, Thrust NOTE: This thrust washer maynot be required if a new crankshafthas been installed. Check the proper Mechanic's Handbook for acceptable end play. Use this .010" thrust washer if excess end play is measured.
69	35261		* Gasket, Mounting flange
118	730194		Rope Guide Kit (Use as required)
182	6201		Screw, 1/4-28 x 7/8"
185	31384A		Pipe, Intake (Incl. 224)
186	34337		Link, Governor spring
206	610973		Terminal (Use as required)
209	30200		Screw, 10-24 x 9/16"
223	650451		Screw, 1/4-20 x 1"
238	650806		Screw, 10-32 x 5/8"
239	34338		* Gasket, Air cleaner
240	34858		Body, Air cleaner
246	34340		Element, Air cleaner
246E	35435		Filter, Pre-air (Use as required)
250	34341A		Cover, Air cleaner
274	26754A		* Gasket, Exhaust (Use as required)
275A	35603		Muffler (Incl. 277)
277A	30063		Screw, Torx T-30, 1/4-20 x 1/2" (Use as req.)
277	650795		Screw, 1/4-20 x 2-1/4" (Use as requir ed)
277	650774		Screw, 1/4-20 x 2-3/8" (Use as requir ed)
277	792005		Screw, 1/4-20 x 2-1/2" (Use as requir ed)
286	35009		Screen, Starter cup
370H	34387		Decal, Instruction (Optional)
370J	34870		Decal, Instruction (Optional)
410	730574		Debris Screen Kit(Incl.370H,411-413)(Opt.)
411	35596		Screen, Debris (Optional)
412	35597		Bracket, Debris screen (Optional)
413	650910		Screw, 8-32 x 1/4 (Optional)
415	730162		Muffler Adapter Kit(Incl.274,277)(Use as req)
425	730571		Starter Muff Kit (Incl.370J,426,427)(Opt.)
426	32203		Starter Air Cleaner (Optional)
427	32204		Starter Air Cleaner Bracket (Optional)
436	611006		Stator Plate Ass'y.(Incl.377,378,437, 442-448)
437	30551		Spring, Breaker box cover
438	610947		Cover, Dust
439	610955		Gasket, Stator cover
440	30992		Cam, Breaker
442	610385		Washer
443	610408		Nut, 8-32
444	29181		Breaker Fastening Screw & Washer
445	610593		Condenser Fastening Screw
446	33356		Terminal, Ground