

# OWNER'S MANUAL

## MODEL NO. C018542STB

### 18.5 HP 42 INCH

### LAWN TRACTOR

- **Assembly**
  - **Operation**
    - **Maintenance**
      - **Service and Adjustments**
        - **Storage**
          - **Troubleshooting**
            - **Repair Parts**

For Parts and Service, contact our authorized distributor:  
call 1-800-849-1297 For Technical Assistance: call 1-800-829-5886

---

# Poulan PRO

**TABLE OF CONTENTS**

Warranty .....	2	Maintenance .....	17
Safety Rules .....	3	Service and Adjustments.....	20
Product Specifications .....	6	Storage .....	25
Assembly/Pre-Operation .....	8	Troubleshooting .....	26
Operation.....	11	Repair Parts.....	30
Maintenance Schedule .....	17		

**WARRANTY**

**LIMITED WARRANTY**

The Manufacturer warrants to the original consumer purchaser that this product as manufactured is free from defects in materials and workmanship. For a period of two (2) years from date of purchase by the original consumer purchaser, we will repair or replace, at our option, without charge for parts or labor incurred in replacing parts, any part which we find to be defective due to materials or workmanship. This Warranty is subject to the following limitations and exclusions.

1. This warranty does not apply to the engine, other than EHP manufactured transaxle/ transmission components, battery (except as noted below) or components parts thereof. Please refer to the applicable manufacturer's warranty on these items.
2. Transportation charges for the movement of any power equipment unit or attachment are the responsibility of the purchaser. Transportation charges for any parts submitted for replacement under this warranty must be paid by the purchaser unless such return is requested by Electrolux Home Products.
3. Battery Warranty: On products equipped with a Battery, we will replace, without charge to you, any battery which we find to be defective in manufacture, during the first ninety (90) days of ownership. After ninety (90) days, we will exchange the Battery, charging you 1/12 of the price of a new Battery for each full month from the date of the original sale. Battery must be maintained in accordance with the instructions furnished.
4. The Warranty period for any products used for rental or commercial purposes is limited to 90 days from the date of original purchase.
5. This Warranty applies only to products which have been properly assembled, adjusted, operated, and maintained in accordance with the instructions furnished. This Warranty does not apply to any product which has been subjected to alteration, misuse, abuse, improper assembly or installation, delivery damage, or to normal wear of the product.
6. Exclusions: Excluded from this Warranty are belts, blades, blade adapters, normal wear, normal adjustments, standard hardware and normal maintenance.
7. In the event you have a claim under this Warranty, you must return the product to an authorized service dealer.

Should you have any unanswered questions concerning this Warranty, please contact:

Electrolux Home Products, Inc. Outdoor Products Customer Service Dept. 250 Bobby Jones Expressway Augusta, GA 30909 USA	In Canada contact: Electrolux Canada Corp. 7075 Ordan Drive Mississauga, Ontario L5T 1K6
--	--

giving the model number, serial number and date of purchase of your product and the name and address of the authorized dealer from whom it was purchased. THIS WARRANTY DOES NOT APPLY TO INCIDENTAL OR CONSEQUENTIAL DAMAGES AND ANY IMPLIED WARRANTIES ARE LIMITED TO THE SAME TIME PERIODS STATED HEREIN FOR OUR EXPRESSED WARRANTIES. Some areas do not allow the limitation of consequential damages or limitations of how long an implied Warranty may last, so the above limitations or exclusions may not apply to you. This Warranty gives you specific legal rights, and you may have other rights which vary from locale to locale. This is a limited Warranty within the meaning of that term as defined in the Magnuson-Moss Act of 1975.

## SAFETY RULES

**IMPORTANT:** This cutting machine is capable of amputating hands and feet and throwing objects. Failure to observe the following safety instructions could result in serious injury or death.

 **WARNING:** In order to prevent accidental starting when setting up, transporting, adjusting or making repairs, always disconnect spark plug wire and place wire where it cannot contact spark plug.

 **WARNING:** Do not coast down a hill in neutral, you may lose control of the tractor.

 **WARNING:** Tow only the attachments that are recommended by and comply with specifications of the manufacturer of your tractor. Use common sense when towing. Operate only at the lowest possible speed when on a slope. Too heavy of a load, while on a slope, is dangerous. Tires can lose traction with the ground and cause you to lose control of your tractor.

 **WARNING:** Engine exhaust, some of its constituents, and certain vehicle components contain or emit chemicals known to the State of California to cause cancer and birth defects or other reproductive harm.

 **WARNING:** Battery posts, terminals and related accessories contain lead and lead compounds, chemicals known to the State of California to cause cancer and birth defects or other reproductive harm.  
**Wash hands after handling.**

### I. GENERAL OPERATION

- Read, understand, and follow all instructions in the manual and on the machine before starting.
- Only allow responsible adults, who are familiar with the instructions, to operate the machine.
- Clear the area of objects such as rocks, toys, wire, etc., which could be picked up and thrown by the blade.
- Be sure the area is clear of other people before mowing. Stop machine if anyone enters the area.
- Never carry passengers.
- Do not mow in reverse unless absolutely necessary. Always look down and behind before and while backing.

- Be aware of the mower discharge direction and do not point it at anyone. Do not operate the mower without either the entire grass catcher or the guard in place.
- Slow down before turning.
- Never leave a running machine unattended. Always turn off blades, set parking brake, stop engine, and remove keys before dismounting.
- Turn off blades when not mowing.
- Stop engine before removing grass catcher or unclogging chute.
- Mow only in daylight or good artificial light.
- Do not operate the machine while under the influence of alcohol or drugs.
- Watch for traffic when operating near or crossing roadways.
- Use extra care when loading or unloading the machine into a trailer or truck.
- Data indicates that operators, age 60 years and above, are involved in a large percentage of riding mower-related injuries. These operators should evaluate their ability to operate the riding mower safely enough to protect themselves and others from serious injury.
- Keep machine free of grass, leaves or other debris build-up which can touch hot exhaust / engine parts and burn. Do not allow the mower deck to plow leaves or other debris which can cause build-up to occur. Clean any oil or fuel spillage before operating or storing the machine. Allow machine to cool before storage.

### II. SLOPE OPERATION

Slopes are a major factor related to loss-of-control and tipover accidents, which can result in severe injury or death. All slopes require extra caution. If you cannot back up the slope or if you feel uneasy on it, do not mow it.

#### DO:

- Mow up and down slopes, not across.
- Remove obstacles such as rocks, tree limbs, etc.

## SAFETY RULES

- Watch for holes, ruts, or bumps. Uneven terrain could overturn the machine. *Tall grass can hide obstacles.*
- Use slow speed. Choose a low gear so that you will not have to stop or shift while on the slope.
- Follow the manufacturer's recommendations for wheel weights or counterweights to improve stability.
- Use extra care with grass catchers or other attachments. These can change the stability of the machine.
- Keep all movement on the slopes *slow* and *gradual*. Do not make sudden changes in speed or direction.
- Avoid starting or stopping on a slope. If tires lose traction, disengage the blades and proceed slowly *straight* down the slope.

### DO NOT:

- *Do not* turn on slopes unless necessary, and then, turn slowly and gradually downhill, if possible.
- *Do not* mow near drop-offs, ditches, or embankments. The mower could suddenly turn over if a wheel is over the edge of a cliff or ditch, or if an edge caves in.
- *Do not* mow on wet grass. Reduced traction could cause sliding.
- *Do not* try to stabilize the machine by putting your foot on the ground.
- *Do not* use grass catcher on steep slopes.

### III. CHILDREN

Tragic accidents can occur if the operator is not alert to the presence of children. Children are often attracted to the machine and the mowing activity. *Never* assume that children will remain where you last saw them.

- Keep children out of the mowing area and under the watchful care of another responsible adult.
- Be alert and turn machine off if children enter the area.
- Before and when backing, look behind and *down* for small children.
- Never carry children. They may fall off and be seriously injured or interfere with safe machine operation.
- Never allow children to operate the machine.

- Use extra care when approaching blind corners, shrubs, trees, or other objects that may obscure vision.

### IV. SERVICE

- Use extra care in handling gasoline and other fuels. They are flammable and vapors are explosive.
  - Use only an approved container.
  - Never remove gas cap or add fuel with the engine running. Allow engine to cool before refueling. Do not smoke.
  - Never refuel the machine indoors.
  - Never store the machine or fuel container inside where there is an open flame, such as a water heater.
- Never run a machine inside a closed area.
- Keep nuts and bolts, especially blade attachment bolts, tight and keep equipment in good condition.
- Never tamper with safety devices. Check their proper operation regularly.
- Keep machine free of grass, leaves, or other debris build-up. Clean oil or fuel spillage. Allow machine to cool before storing.
- Stop and inspect the equipment if you strike an object. Repair, if necessary, before restarting.
- Never make adjustments or repairs with the engine running.
- Grass catcher components are subject to wear, damage, and deterioration, which could expose moving parts or allow objects to be thrown. Frequently check components and replace with manufacturer's recommended parts, when necessary.
- Mower blades are sharp and can cut. Wrap the blade(s) or wear gloves, and use extra caution when servicing them.
- Check brake operation frequently. Adjust and service as required.

## SAFETY RULES



- Be sure the area is clear of other people before mowing. Stop machine if anyone enters the area.
- Never carry passengers or children even with the blades off.
- Do not mow in reverse unless absolutely necessary. Always look down and behind before and while backing.
- Never carry children. They may fall off and be seriously injured or interfere with safe machine operation.
- Keep children out of the mowing area and under the watchful care of another responsible adult.
- Be alert and turn machine off if children enter the area.
- Before and when backing, look behind and down for small children.
- Mow up and down slopes ( $15^{\circ}$  Max), not across.
- Remove obstacles such as rocks, tree limbs, etc.
- Watch for holes, ruts, or bumps. Uneven terrain could overturn the machine. Tall grass can hide obstacles.
- Use slow speed. Choose a low gear so that you will not have to stop or shift while on the slope.
- Avoid starting or stopping on a slope. If tires lose traction, disengage the blades and proceed slowly straight down the slope.
- If machine stops while going uphill, disengage blades, shift into reverse and back down slowly.
- Do not turn on slopes unless necessary, and then, turn slowly and gradually downhill, if possible.

**PRODUCT SPECIFICATIONS**

Gasoline Capacity and Type:	4.0 Unleaded Regular
Oil Type (API-SG-SL):	SAE 30 (above 32°F) SAE 5W-30(below 32°F)
Oil Capacity:	W/Filter: 3.5 Pints W/O Filter: 3.0 Pints
Spark Plug: (Gap: .030")	Champion RC12YC
Ground Speed (MPH):	
Forward:	1st     1.2 2nd     1.5 3rd     2.4 4th     3.5 5th     4.8 6th     5.3
Reverse:	1.5
Tire Pressure:	Front: 14 PSI Rear: 10 PSI
Charging System:	9 Amps @ 3600 RPM
Battery:	Amp/Hr: 28 Min. CCA: 230 Case Size: U1R
Blade Bolt Torque: 27-35 Ft. Lbs.	

**CUSTOMER RESPONSIBILITIES**

- Read and observe the safety rules.
- Follow a regular schedule in maintaining, caring for and using your tractor.
- Follow the instructions under “Maintenance” and “Storage” sections of this owner’s manual.

**⚠WARNING:** This tractor is equipped with an internal combustion engine and should not be used on or near any unimproved forest-covered, brush-covered or grass-covered land unless the engine’s exhaust system is equipped with a spark arrester meeting applicable local or state laws (if any). If a spark arrester is used, it should be maintained in effective working order by the operator.

In the state of California the above is required by law (Section 4442 of the California Public Resources Code). Other states may have similar laws. Federal laws apply on federal lands. A spark arrester for the muffler is available through your nearest authorized service center/department (See REPAIR PARTS section of this manual).

**CONGRATULATIONS** on your purchase of a new tractor. It has been designed, engineered and manufactured to give you the best possible dependability and performance. Should you experience any problem you cannot easily remedy, please contact your nearest authorized service center/department. We have competent, well-trained technicians and the proper tools to service or repair this tractor. Please read and retain this manual. The instructions will enable you to assemble and maintain your tractor properly. Always observe the “SAFETY RULES”.



# UNASSEMBLED PARTS

## Steering Wheel

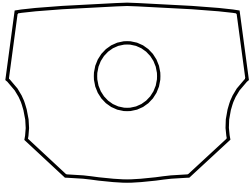

Steering Wheel Insert

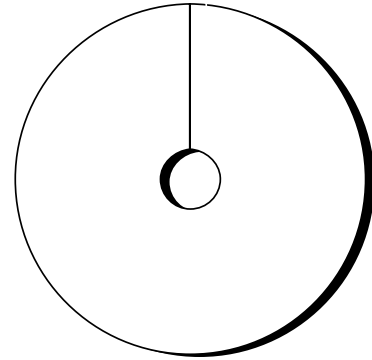
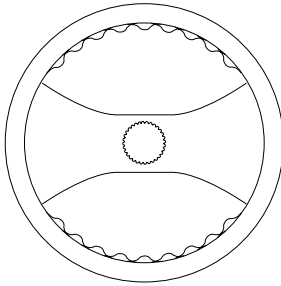

(1) Large Flat Washer

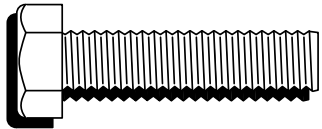

(1) Hex Bolt 1/4-28 x 1-1/4



Steering Sleeve Extension



Steering Sleeve

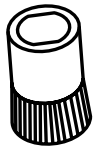

Steering Wheel Adapter

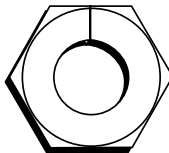

(1) Hex nut 1/2-20

## Seat

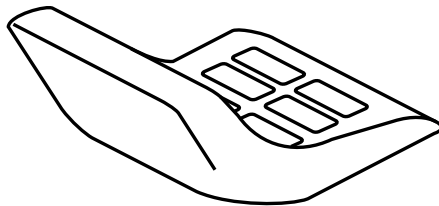

(1) Washer  
17/32 x 1-3/16 x 12 Gauge

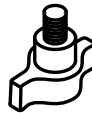

(1) Knob

## Slope Sheet



(1) Oil Drain Tube  
For Future Use

## Keys

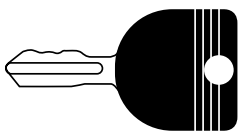

(2) Keys

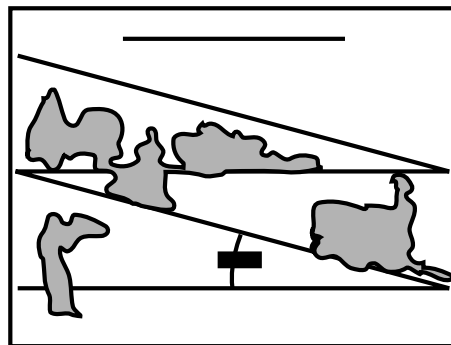

## ASSEMBLY/PRE-OPERATION

Your new tractor has been assembled at the factory with the exception of those parts left unassembled for shipping purposes. To ensure safe and proper operation of your tractor all parts and hardware you assemble must be tightened securely. Use the correct tools as necessary to insure proper tightness. Review the video cassette before you begin.

### TOOLS REQUIRED FOR ASSEMBLY

A socket wrench set will make assembly easier. Standard wrench sizes you need are listed below.

- (1) 3/4" wrench      (1) Pliers
- (2) 7/16" wrench    (1) Utility knife
- (1) Tire pressure gauge

When right or left hand is mentioned in this manual, it means, from your point of view, when you are in the operating position (seated behind the steering wheel).

### TO REMOVE TRACTOR FROM CARTON

#### UNPACK CARTON

1. Remove all accessible loose parts and parts boxes from carton.
2. Cut along dotted lines on all four panels of carton. Remove end panels and lay side panels flat.
3. Check for any additional loose parts or cartons and remove.

### BEFORE REMOVING TRACTOR FROM SKID

#### ATTACH STEERING WHEEL

1. Remove locknut and large flat washer from steering shaft.
2. Position front wheels of the tractor so they are pointing straight forward.
3. Slide the steering sleeve over the steering shaft.
4. Align tabs and press steering sleeve extension into bottom of steering wheel.
5. Position steering wheel so cross bars are horizontal (left to right) and slide onto steering wheel adaptor.
6. Secure steering wheel to steering shaft with locknut and large flat washer previously removed. Tighten securely.
7. Snap steering wheel insert into center of steering wheel.
8. Remove protective materials from tractor hood and grill.

**IMPORTANT:** Check for and remove any staples in skid that may puncture tires where tractor is to roll off skid.

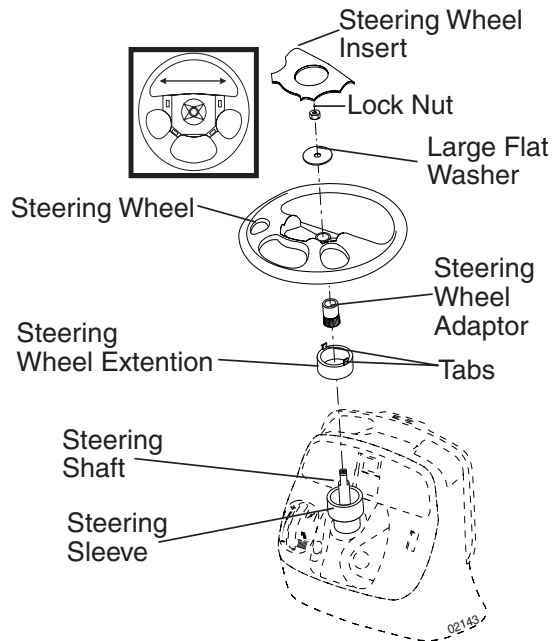

### CHECK BATTERY

1. Lift hood to raised position.

**NOTE:** If this battery is put into service after month and year indicated on label (label located between terminals) charge battery for minimum of one hour at 6-10 amps. (See "BATTERY" in Maintenance section of this manual for charging instructions).

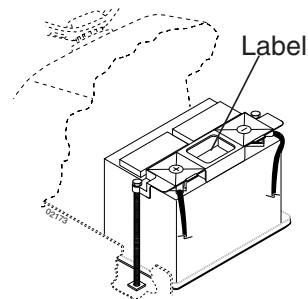

### INSTALL SEAT

Adjust seat before tightening adjustment knob.

1. Remove adjustment knob and flat washer securing seat to cardboard packing and set aside for assembly of seat to tractor.



2. Pivot seat upward and remove from the cardboard packing. Remove the cardboard packing and discard.
3. Place seat on seat pan so head of shoulder bolt is positioned over large slotted hole in pan.
4. Push down on seat to engage shoulder bolt in slot and pull seat towards rear of tractor.
5. Pivot seat and pan forward and assemble adjustment knob and flat washer loosely. Do not tighten.
6. Lower seat into operating position and sit in seat.
7. Slide seat until a comfortable position is reached which allows you to press clutch/brake pedal all the way down.
8. Get off seat without moving its adjusted position.
9. Raise seat and tighten adjustment knob securely.

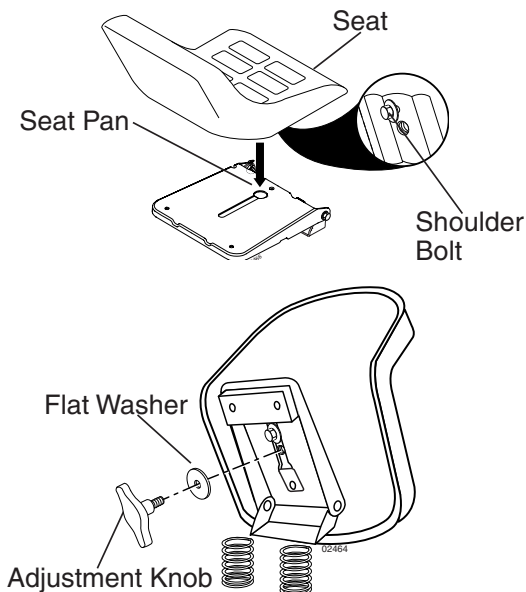

**NOTE:** You may now roll or drive your tractor off the skid. Follow the appropriate instruction below to remove the tractor from the skid.

### TO ROLL TRACTOR OFF SKID (See Operation section for location and function of controls)

1. Press lift lever plunger and raise attachment lift lever to its highest position.
2. Release parking brake by depressing clutch/brake pedal.
3. Place gearshift lever in neutral (N) position.
4. Roll tractor forward off skid.
5. Remove banding holding deflector shield up against tractor.

### TO DRIVE TRACTOR OFF SKID (See Operation section for location and function of controls)

**WARNING:** Before starting, read, understand and follow all instructions in the Operation section of this manual. Be sure tractor is in a well-ventilated area. Be sure the area in front of tractor is clear of other people and objects.

1. Be sure all the above assembly steps have been completed.
2. Check engine oil level and fill fuel tank with gasoline.
3. Sit on seat in operating position, depress clutch/brake pedal and set the parking brake.
4. Place gear shift lever in neutral (N) position.
5. Press lift lever plunger and raise attachment lift lever to its highest position.
6. Start the engine. After engine has started, move throttle control to idle position.
7. Depress clutch/brake pedal into full "BRAKE" position and hold. Move gearshift lever to 1st gear.
8. Slowly release clutch/brake pedal and slowly drive tractor off skid.
9. Apply brake to stop tractor, set parking brake and place gearshift lever in neutral position.
10. Turn ignition key to "STOP" position. Continue with the instructions that follow.

### INSTALL MULCHER PLATE

(If previously removed)

1. Raise and hold deflector shield in upright position.
2. Place front of mulcher plate over front of mower deck opening and slide into place, as shown.
3. Hook front latch into hole on front of mower deck.
4. Hook rear latch into hole on back of mower deck.

**CAUTION:** Do not remove deflector shield from mower.

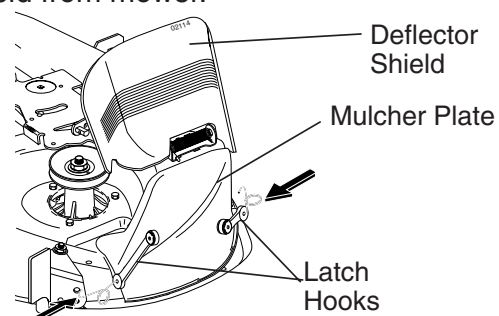

## TO CONVERT TO BAGGING OR DISCHARGING

Simply remove mulcher plate and store in a safe place. Your mower is now ready for discharging or installation of optional grass catcher accessory.

**NOTE:** It is not necessary to change blades. The mulching blades are designed for discharging and bagging also.

## REPOSITION RIGHT REAR GAUGE WHEEL

For shipping purposes, the right rear gauge wheel assembly is mounted upside down on the mower. Remove the gauge wheel assembly and reinstall from the bottom as shown. To adjust gauge wheels, see the Operation section in this manual.

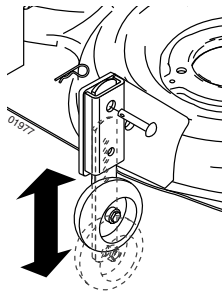

## CHECK TIRE PRESSURE

The tires on your tractor were overinflated at the factory for shipping purposes. Correct tire pressure is important for best cutting performance.

- Reduce tire pressure to PSI shown in “PRODUCT SPECIFICATIONS” section of this manual.

## CHECK FOR PROPER POSITION OF ALL BELTS

See the figures that are shown for replacing motion and mower blade drive belts in the Service and Adjustments section of this manual. Verify that the belts are routed correctly.

## CHECK DECK LEVELNESS

For best cutting results, mower housing should be properly leveled. See “TO LEVEL MOWER HOUSING” in the Service and Adjustments section of this manual.

## CHECK BRAKE SYSTEM

After you learn how to operate your tractor, check to see that the brake is properly adjusted. See “TO ADJUST BRAKE” in the Service and Adjustments section of this manual.

### ✓CHECKLIST

Before you operate your new tractor, we wish to assure that you receive the best performance and satisfaction from this Quality Product.

Please review the following checklist:

- ✓ All assembly instructions have been completed.
- ✓ No remaining loose parts in carton.
- ✓ Battery is properly prepared and charged. (Minimum 1 hour at 6 amps).
- ✓ Seat is adjusted comfortably and tightened securely.
- ✓ All tires are properly inflated. (For shipping purposes, the tires were overinflated at the factory).
- ✓ Be sure mower deck is properly leveled side-to-side/front-to-rear for best cutting results. (Tires must be properly inflated for leveling).
- ✓ Check mower and drive belts. Be sure they are routed properly around pulleys and inside all belt keepers.
- ✓ Check wiring. See that all connections are still secure and wires are properly clamped.

While learning how to use your tractor, pay extra attention to the following important items:

- ✓ Engine oil is at proper level.
- ✓ Fuel tank is filled with fresh, clean, regular unleaded gasoline.
- ✓ Become familiar with all controls, their location and function. Operate them before you start the engine.
- ✓ Be sure brake system is in safe operating condition.

## OPERATION

These symbols may appear on your tractor or in literature supplied with the product. Learn and understand their meaning.

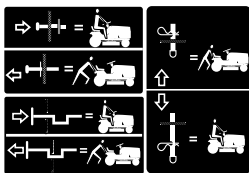
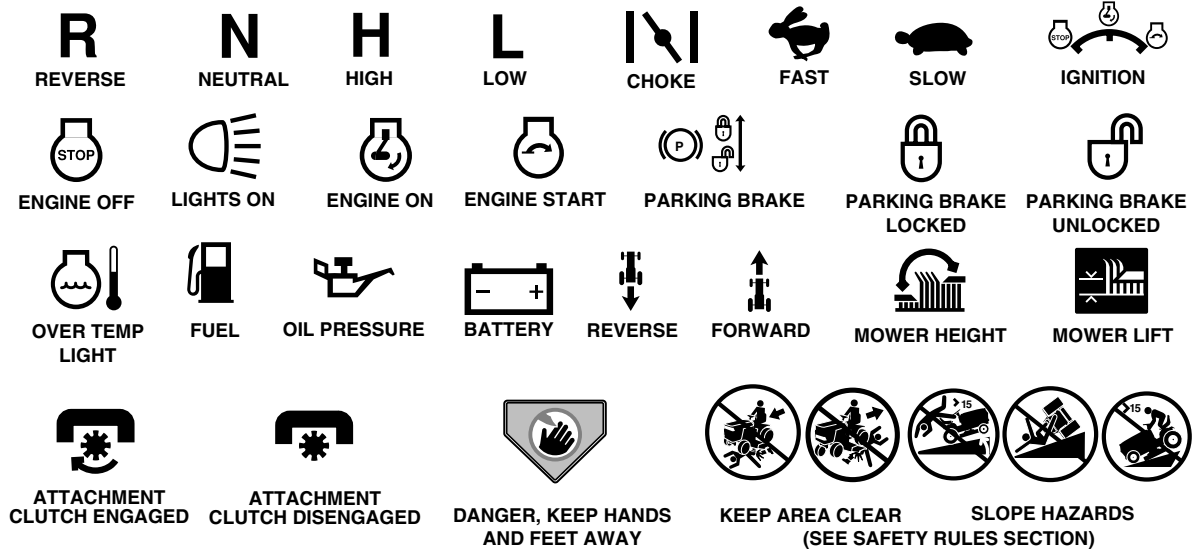

FREE WHEEL  
(Automatic Models only)



Failure to follow instructions could result in serious injury or death. The safety alert symbol is used to identify safety information about hazards which can result in death, serious injury and/or property damage.



**DANGER** indicates a hazard which, if not avoided, will result in death or serious injury.



**WARNING** indicates a hazard which, if not avoided, could result in death or serious injury.



**CAUTION** indicates a hazard which, if not avoided, might result in minor or moderate injury.

**CAUTION** when used **without** the alert symbol, indicates a situation that **could result in damage to the tractor and/or engine.**



**HOT SURFACES** indicates a hazard which, if not avoided, could result in death, serious injury and/or property damage.



**FIRE** indicates a hazard which, if not avoided, could result in death, serious injury and/or property damage.

## KNOW YOUR TRACTOR

### READ THIS OWNER'S MANUAL AND SAFETY RULES BEFORE OPERATING YOUR TRACTOR

Compare the illustrations with your tractor to familiarize yourself with the locations of various controls and adjustments. Save this manual for future reference.

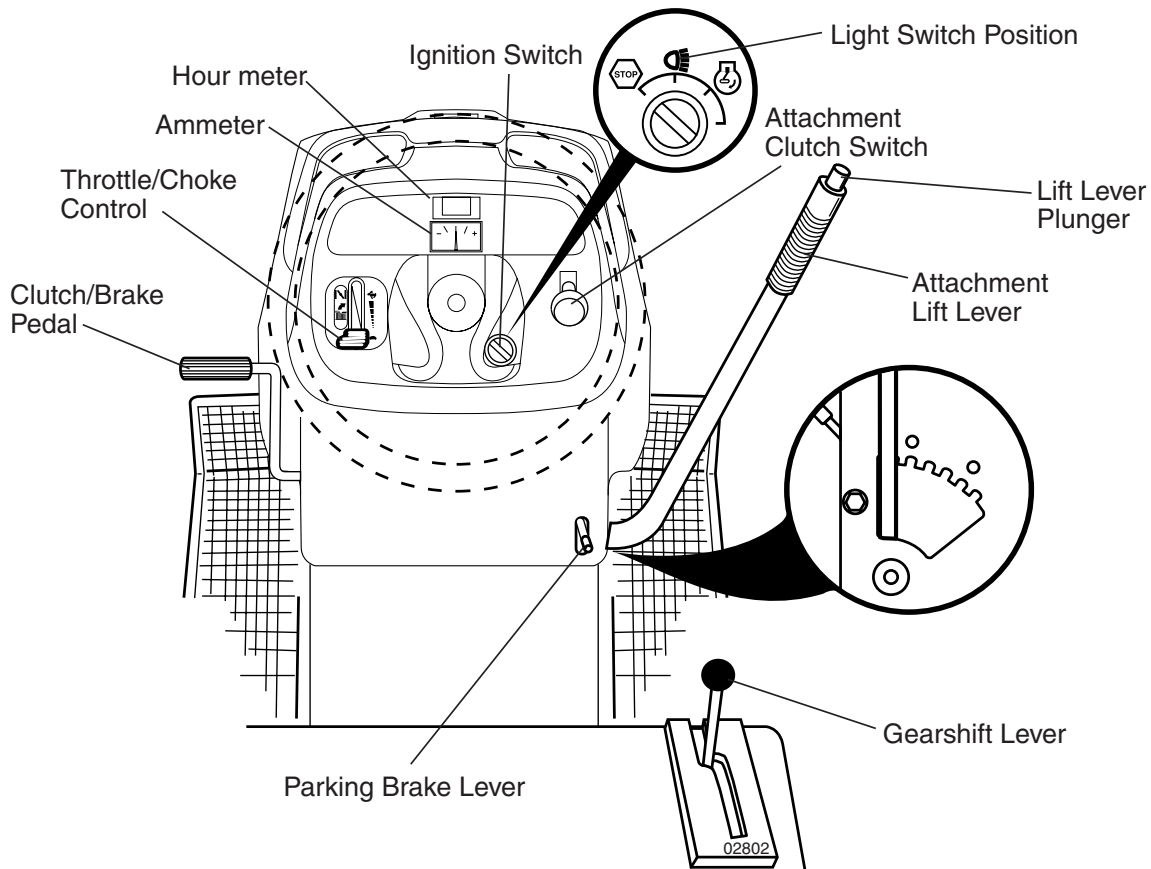

---

Our tractors conform to the safety standards of the American National Standards Institute.

---

**ATTACHMENT CLUTCH SWITCH** - Used to engage the mower blades or other attachments mounted to your tractor.

**ATTACHMENT LIFT LEVER** - Used to raise, lower, and adjust the mower deck or other attachments mounted to your tractor.

**CLUTCH/BRAKE PEDAL** - Used for declutching and braking the tractor and starting the engine.

**GEARSHIFT LEVER** - Selects the speed and direction of tractor.

**IGNITION SWITCH** - Used for starting and stopping the engine.

**LIFT LEVER PLUNGER** - Used to release attachment lift lever when changing its position.

**LIGHT SWITCH POSITION** - Turns the headlights on and off.

**PARKING BRAKE LEVER** - Locks clutch/brake pedal into the brake position.

**THROTTLE/CHOKE CONTROL** - Used for starting and controlling engine speed.

**AMMETER** - Indicates charging (+) or discharging (-) of battery.

**HOURLY METER** - Indicates hours of operation.



The operation of any tractor can result in foreign objects thrown into the eyes, which can result in severe eye damage. Always wear safety glasses or eye shields while operating your tractor or performing any adjustments or repairs. We recommend a wide vision safety mask over spectacles or standard safety glasses.

## HOW TO USE YOUR TRACTOR TO SET PARKING BRAKE

Your tractor is equipped with an operator presence sensing switch. When engine is running, any attempt by the operator to leave the seat without first setting the parking brake will shut off the engine.

1. Depress clutch/brake pedal all the way down and hold.
2. Pull parking brake lever up and release pressure from clutch/brake pedal. Pedal should remain in brake position. Make sure parking brake will hold tractor secure.

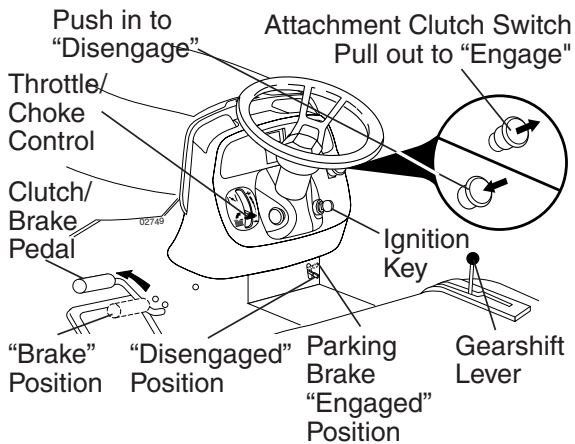

## STOPPING

### MOWER BLADES -

- To stop mower blades, push attachment clutch switch in to disengaged position.

### GROUND DRIVE -

- To stop ground drive, depress clutch/brake pedal all the way down.
- Move gearshift lever to neutral (N) position.

### ENGINE -

- Move throttle control between half and full speed (fast) position.

**NOTE:** Failure to move throttle control between half and full speed (fast) position, before stopping, may cause engine to “backfire”.

- Turn ignition key to “STOP” position and remove key. Always remove key when leaving tractor to prevent unauthorized use.
- Never use choke to stop engine.

**IMPORTANT:** Leaving the ignition switch in any position other than “STOP” will cause the battery to discharge and go dead.

**NOTE:** Under certain conditions when tractor is standing idle with the engine running, hot engine exhaust gases may cause “browning” of grass. To eliminate this possibility, always stop engine when stopping tractor on grass areas.

**CAUTION:** Always stop tractor completely, as described above, before leaving the operator’s position.

## TO USE THROTTLE CONTROL

Always operate engine at full throttle.

- Operating engine at less than full throttle reduces the battery charging rate.
- Full throttle offers the best bagging and mower performance.

## TO MOVE FORWARD AND BACKWARD

The direction and speed of movement is controlled by the gearshift lever.

1. Start tractor with clutch/brake pedal depressed and gearshift lever in neutral (N) position.
2. Move gearshift lever to desired position.
3. Slowly release clutch/brake pedal to start movement.

**IMPORTANT:** Bring tractor to a complete stop before shifting or changing gears. Failure to do so will shorten the useful life of your transaxle.

## TO ADJUST MOWER CUTTING HEIGHT

The position of the attachment lift lever determines the cutting height.

- Grasp lift lever.
- Press plunger with thumb and move lever to desired position.

The cutting height range is approximately 1-1/2 to 4". The heights are measured from the ground to the blade tip with the engine not running. These heights are approximate and may vary depending upon soil conditions, height of grass and types of grass being mowed.



- The average lawn should be cut to approximately 2-1/2 inches during the cool season and to over 3 inches during hot months. For healthier and better looking lawns, mow often and after moderate growth.
- For best cutting performance, grass over 6 inches in height should be mowed twice. Make the first cut relatively high; the second to desired height.

### TO ADJUST GAUGE WHEELS

Gauge wheels are properly adjusted when they are slightly off the ground when mower is at the desired cutting height in operating position. Gauge wheels then keep the deck in proper position to help prevent scalping in most terrain conditions.

**NOTE:** Be sure tractor is on a flat level surface.

1. Lower mower and adjust mower to desired cutting height (See "TO ADJUST MOWER CUTTING HEIGHT" in this section of manual).
2. Remove retainer spring and clevis pin which secure each gauge wheel bar.
3. Lower gauge wheels to ground. Raise gauge wheels slightly to align holes in bracket and gauge wheel bar and insert clevis pin. Gauge wheels should be slightly off the ground.
4. Replace retainer spring into clevis pin.
5. Be sure all gauge wheels are in the same setting.

**IMPORTANT:** Be sure to readjust gauge wheels if you change the cutting height of the mower deck.

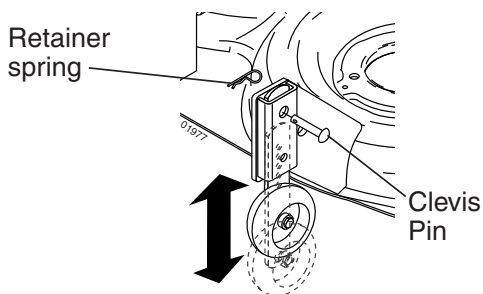

### TO OPERATE MOWER

Your tractor is equipped with an operator presence sensing switch. Any attempt by the operator to leave the seat with the engine running and the attachment clutch engaged will shut off the engine. You must remain fully and centrally positioned in the seat to prevent the engine from hesitating or cutting off when operating your equipment on rough, rolling terrain or hills.

1. Select desired height of cut.
2. Start mower blades by engaging attachment clutch control.

TO STOP MOWER BLADES - disengage attachment clutch control.

**CAUTION:** Do not operate the mower without either the entire grass catcher, on mowers so equipped, or the deflector shield in place.

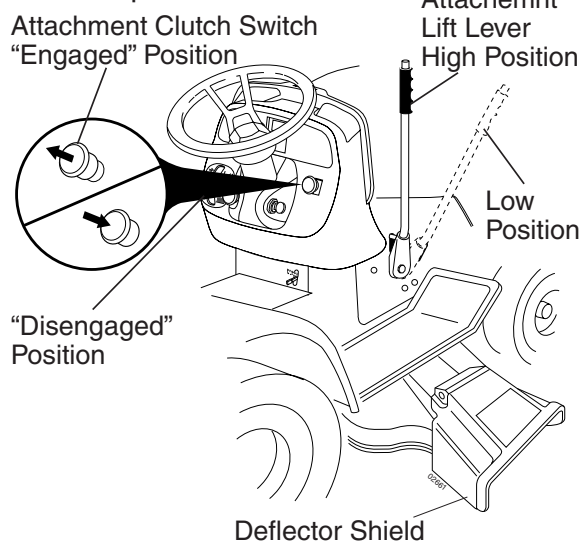

### TO OPERATE ON HILLS

- WARNING:** Do not drive up or down hills with slopes greater than 15° and do not drive across any slope. Use the slope guide provided at the back of this manual.
- Choose the slowest speed before starting up or down hills.
  - Avoid stopping or changing speed on hills.
  - If slowing is necessary, move throttle control lever to slower position.
  - If stopping is absolutely necessary, push clutch/brake pedal quickly to brake position and engage parking brake.
  - Move gearshift lever to 1st gear. Be sure you have allowed room for tractor to roll slightly as you restart movement.
  - To restart movement, slowly release parking brake and clutch/brake pedal.
  - Make all turns slowly.

### TO TRANSPORT

- Raise attachment lift to highest position with attachment lift control.
- When pushing or towing your tractor, be sure gearshift lever is in neutral (N) position.
- Do not push or tow tractor at more than five (5) MPH.

**NOTE:** To protect hood from damage when transporting your tractor on a truck or a trailer, be sure hood is closed and secured to tractor. Use an appropriate means of tying hood to tractor (rope, cord, etc.).



## TOWING CARTS AND OTHER ATTACHMENTS

Tow only the attachments that are recommended by and comply with specifications of the manufacturer of your tractor. Use common sense when towing. Too heavy of a load, while on a slope, is dangerous. Tires can lose traction with the ground and cause you to lose control of your tractor.

## BEFORE STARTING THE ENGINE CHECK ENGINE OIL LEVEL

The engine in your tractor has been shipped, from the factory, already filled with summer weight oil.

1. Check engine oil with tractor on level ground.
  2. Remove oil fill cap/dipstick and wipe clean, reinsert the dipstick and screw cap tight, wait for a few seconds, remove and read oil level. If necessary, add oil until "FULL" mark on dipstick is reached. Do not overfill.
- For cold weather operation you should change oil for easier starting (See "OIL VISCOSITY CHART" in the Maintenance section of this manual).
  - To change engine oil, see the Maintenance section in this manual.

## ADD GASOLINE

- Fill fuel tank to bottom of filler neck. Do not overfill. Use fresh, clean, regular unleaded gasoline with a minimum of 87 octane. (Use of leaded gasoline will increase carbon and lead oxide deposits and reduce valve life). Do not mix oil with gasoline. Purchase fuel in quantities that can be used within 30 days to assure fuel freshness.

**▲CAUTION:** Wipe off any spilled oil or fuel. Do not store, spill or use gasoline near an open flame.

**IMPORTANT:** When operating in temperatures below 32°F (0°C), use fresh, clean winter grade gasoline to help insure good cold weather starting.

**▲CAUTION:** Alcohol blended fuels (called gasohol or using ethanol or methanol) can attract moisture which leads to separation and formation of acids during storage. Acidic gas can damage the fuel system of an engine while in storage. To avoid engine problems, the fuel system should be emptied before storage of 30 days or longer. Drain the gas tank, start the engine and let it run until the fuel lines and carburetor are empty. Use fresh fuel next season. See Storage Instructions for additional information. Never use engine or carburetor cleaner products in the fuel tank or permanent damage may occur.

## TO START ENGINE

When starting the engine for the first time or if the engine has run out of fuel, it will take extra cranking time to move fuel from the tank to the engine.

1. Sit on seat in operating position, depress clutch/brake pedal and set parking brake.
  2. Place gear shift lever in neutral (N) position.
  3. Move attachment clutch to disengaged position.
  4. Move throttle control to choke position.
- NOTE:** Before starting, read the warm and cold starting procedures below.
5. Insert key into ignition and turn key clockwise to start position and release key as soon as engine starts. Do not run starter continuously for more than fifteen seconds per minute. If the engine does not start after several attempts, move throttle control to fast position, wait a few minutes and try again. If engine still does not start, move the throttle control back to the choke position and retry.

## WARM WEATHER STARTING (50° F and above)

6. When engine starts, move the throttle control to the fast position.
- The attachments and ground drive can now be used. If the engine does not accept the load, restart the engine and allow it to warm up for one minute using the choke as described above.

## COLD WEATHER STARTING ( 50° F and below)

6. When engine starts, leave throttle control in choke position until engine warms up and begins to run roughly. Once rough running begins, immediately move the throttle control to the fast position. Engine warm-up may take from several seconds to several minutes (the colder the temperature, the longer the warm-up).
- The attachments can also be used during the engine warm-up period.

**NOTE:** If at a high altitude (above 3000 feet) or in cold temperatures (below 32 F) the carburetor fuel mixture may need to be adjusted for best engine performance (see "TO ADJUST CARBURETOR" in the Service and Adjustments section of this manual).

## MOWING TIPS

- Mower should be properly leveled for best mowing performance. See "TO LEVEL MOWER HOUSING" in the Service and Adjustments section of this manual.
- The left hand side of mower should be used for trimming.
- Drive so that clippings are discharged onto the area that has already been cut. Have the cut area to the right of the tractor. This will result in a more even distribution of clippings and more uniform cutting.
- When mowing large areas, start by turning to the right so that clippings will discharge away from shrubs, fences, driveways, etc. After one or two rounds, mow in the opposite direction making left hand turns until finished.

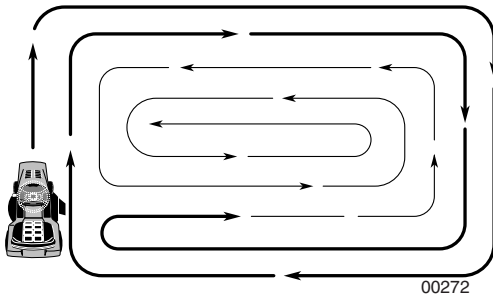

- If grass is extremely tall, it should be mowed twice to reduce load and possible fire hazard from dried clippings. Make first cut relatively high; the second to the desired height.
- Do not mow grass when it is wet. Wet grass will plug mower and leave undesirable clumps. Allow grass to dry before mowing.
- **Always operate engine at full throttle when mowing** to assure better mowing performance and proper discharge of material. Regulate ground speed by selecting a low enough gear to give the mower cutting performance as well as the quality of cut desired.
- When operating attachments, select a ground speed that will suit the terrain and give best performance of the attachment being used.

**IMPORTANT:** For best performance, keep mower housing free of built-up grass and trash. Clean after each use.

- The special mulching blade will recut the grass clippings many times and reduce them in size so that as they fall onto the lawn they will disperse into the grass and not be noticed. Also, the mulched grass will biodegrade quickly to provide nutrients for the lawn. Always mulch with your highest engine (blade) speed as this will provide the best recutting action of the blades.
- Avoid cutting your lawn when it is wet. Wet grass tends to form clumps and interferes with the mulching action. The best time to mow your lawn is the early afternoon. At this time the grass has dried, yet the newly cut area will not be exposed to direct sunlight.
- For best results, adjust the mower cutting height so that the mower cuts off only the top one-third of the grass blades. For extremely heavy grass, reduce your width of cut on each pass and mow slowly.

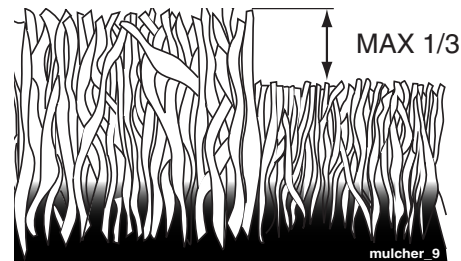

- Certain types of grass and grass conditions may require that an area be mulched a second time to completely hide the clippings. When doing a second cut, mow across (perpendicular) to the first cut path.
- Change your cutting pattern from week to week. Mow north to south one week then change to east to west the next week. This will help prevent matting and graining of the lawn.

# MAINTENANCE

<b>MAINTENANCE SCHEDULE</b>		SERVICE DATES						
FILL IN DATES AS YOU COMPLETE REGULAR SERVICE		BEFORE EACH USE	EVERY 8 HOURS	EVERY 25 HOURS	EVERY 50 HOURS	EVERY 100 HOURS	EVERY SEASON	BEFORE STORAGE
<b>T R A C T O R</b>	Check Brake Operation	✓	✓					
	Check Tire Pressure	✓	✓					
	Check Operator Presence and Interlock Systems	✓						
	Check for Loose Fasteners	✓			✓ <sub>5</sub>		✓	
	Sharpen/Replace Mower Blades			✓ <sub>3</sub>				
	Lubrication Chart			✓			✓	
	Check Battery Level			✓ <sub>4</sub>				
	Clean Battery and Terminals			✓			✓	
	Check Transaxle Cooling			✓				
	Check V-Belts				✓			
<b>E N G I N E</b>	Check Engine Oil Level	✓	✓					
	Change Engine Oil (with oil filter)			✓ <sub>1,2</sub>			✓	
	Change Engine Oil (without oil filter)			✓ <sub>1,2</sub>			✓	
	Clean Air Filter			✓ <sub>2</sub>				
	Clean Air Screen			✓ <sub>2</sub>				
	Inspect Muffler/Spark Arrester			✓				
	Replace Oil Filter (If equipped)				✓ <sub>1,2</sub>			
	Clean Engine Cooling Fins				✓ <sub>2</sub>			
	Replace Spark Plug				✓	✓		
	Replace Air Filter Paper Cartridge				✓ <sub>2</sub>			
Replace Fuel Filter					✓			

1 - Change more often when operating under a heavy load or in high ambient temperatures.  
2 - Service more often when operating in dirty or dusty conditions.

3 - Replace blades more often when mowing in sandy soil.  
4 - Not required if equipped with maintenance-free battery.  
5 - Tighten front axle pivot bolt to 35 ft.-lbs. maximum. Do not overtighten.

## GENERAL RECOMMENDATIONS

The warranty on this tractor does not cover items that have been subjected to operator abuse or negligence. To receive full value from the warranty, operator must maintain tractor as instructed in this manual.

Some adjustments will need to be made periodically to properly maintain your tractor.

At least once a season, check to see if you should make any of the adjustments described in the Service and Adjustments section of this manual.

- At least once a year you should replace the spark plug, clean or replace air filter, and check blades and belts for wear. A new spark plug and clean air filter assure proper air-fuel mixture and help your engine run better and last longer.

## BEFORE EACH USE

- Check engine oil level.
- Check brake operation.
- Check tire pressure.
- Check operator presence and interlock systems for proper operation.
- Check for loose fasteners.

## LUBRICATION CHART

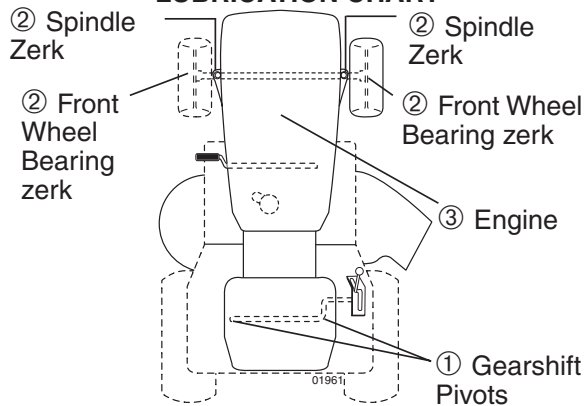

- ① SAE 30 or 10w30 Motor Oil
- ② General Purpose Grease
- ③ Refer to Maintenance "ENGINE" Section

**IMPORTANT:** Do not oil or grease the pivot points which have special nylon bearings. Viscous lubricants will attract dust and dirt that will shorten the life of the self-lubricating bearings. If you feel they must be lubricated, use only a dry, powdered graphite type lubricant sparingly.

## TRACTOR

Always observe safety rules when performing any maintenance.

### BRAKE OPERATION

If tractor requires more than five (5) feet to stop at highest speed in highest gear on a level, dry concrete or paved surface, then brake must be checked and adjusted. (See "TO ADJUST BRAKE" in the Service and Adjustments section of this manual).

### TIRES

- Maintain proper air pressure in all tires (See "PRODUCT SPECIFICATIONS" section of this manual).
- Keep tires free of gasoline, oil, or insect control chemicals which can harm rubber.
- Avoid stumps, stones, deep ruts, sharp objects and other hazards that may cause tire damage.

**NOTE:** To seal tire punctures and prevent flat tires due to slow leaks, tire sealant may be purchased from your local parts dealer. Tire sealant also prevents tire dry rot and corrosion.

### OPERATOR PRESENCE SYSTEM

Be sure operator presence and interlock systems are working properly. If your tractor does not function as described, repair the problem immediately.

- The engine should not start unless the brake pedal is fully depressed and attachment clutch control is in the disengaged position.
- When the engine is running, any attempt by the operator to leave the seat without first setting the parking brake should shut off the engine.
- When the engine is running and the attachment clutch is engaged, any attempt by the operator to leave the seat should shut off the engine.
- The attachment clutch should never operate unless the operator is in the seat.

### BLADE CARE

For best results mower blades must be kept sharp. Replace bent or damaged blades.

### BLADE REMOVAL

1. Raise mower to highest position to allow access to blades.
2. Remove blade bolt, lock washer and flat washer securing blade.
3. Install new or resharpened blade with trailing edge up towards deck as shown.

**IMPORTANT:** To ensure proper assembly, center hole in blade must align with star on mandrel assembly.

4. Reassemble blade bolt, lock washer and flat washer in exact order as shown.
5. Tighten blade bolt securely (27-35 Ft. Lbs. torque).

**IMPORTANT:** Blade bolt is heat treated. If bolt needs replacing, replace only with approve bolt shown in the Repair Parts.

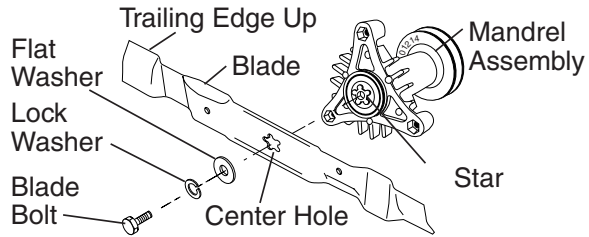

### TO SHARPEN BLADE

**NOTE:** We do not recommend sharpening blade - but if you do, be sure the blade is balanced.

Care should be taken to keep the blade balanced. An unbalanced blade will cause excessive vibration and eventual damage to mower and engine.

- The blade can be sharpened with a file or on a grinding wheel. Do not attempt to sharpen while on the mower.
- To check blade balance, you will need a 5/8" diameter steel bolt, pin, or a cone balancer. (When using a cone balancer, follow the instructions supplied with balancer.)

**NOTE:** Do not use a nail for balancing blade. The lobes of the center hole may appear to be centered, but are not.

- Slide blade on to an unthreaded portion of the steel bolt or pin and hold the bolt or pin parallel with the ground. If blade is balanced, it should remain in a horizontal position. If either end of the blade moves downward, sharpen the heavy end until the blade is balanced.

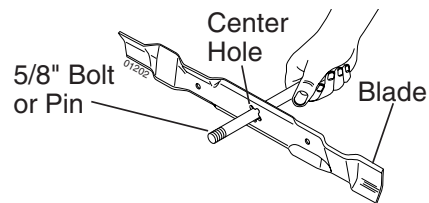

### BATTERY

Your tractor has a battery charging system which is sufficient for normal use. However, periodic charging of the battery with an automotive charger will extend its life.

- Keep battery and terminals clean.
- Keep battery bolts tight.
- Keep small vent holes open.
- Recharge at 6-10 amperes for 1 hour.

**NOTE:** The original equipment battery on your tractor is maintenance free. Do not attempt to open or remove caps or covers. Adding or checking level of electrolyte is not necessary.

### TO CLEAN BATTERY AND TERMINALS

Corrosion and dirt on the battery and terminals can cause the battery to "leak" power.

1. Remove terminal guard.



2. Disconnect BLACK battery cable first then RED battery cable and remove battery from tractor.
3. Rinse the battery with plain water and dry.
4. Clean terminals and battery cable ends with wire brush until bright.
5. Coat terminals with grease or petroleum jelly.
6. Reinstall battery (See "REPLACING BATTERY" in the SERVICE AND ADJUSTMENTS section of this manual).

### TRANSAXLE COOLING

Keep transaxle free from build-up of dirt and chaff which can restrict cooling.

### V-BELTS

Check V-belts for deterioration and wear after 100 hours of operation and replace if necessary. The belts are not adjustable. Replace belts if they begin to slip from wear.

### ENGINE

#### LUBRICATION

Only use high quality detergent oil rated with API service classification SG-SL. Select the oil's SAE viscosity grade according to your expected operating temperature.

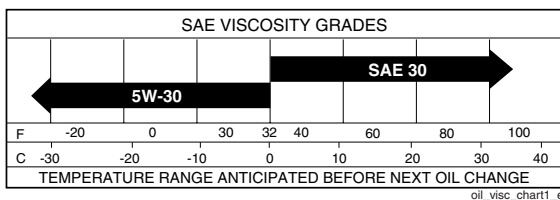

**NOTE:** Although multi-viscosity oils (5W30, 10W30 etc.) improve starting in cold weather, they will result in increased oil consumption when used above 32°F. Check your engine oil level more frequently to avoid possible engine damage from running low on oil.

Change the oil after every 50 hours of operation or at least once a year if the tractor is not used for 50 hours in one year. Check the crankcase oil level before starting the engine and after each eight (8) hours of operation. Tighten oil fill cap/dipstick securely each time you check the oil level.

#### TO CHANGE ENGINE OIL

Determine temperature range expected before oil change. All oil must meet API service classification SG-SL.

- Be sure tractor is on level surface.
  - Oil will drain more freely when warm.
  - Catch oil in a suitable container.
1. Remove oil fill cap/dipstick. Be careful not to allow dirt to enter the engine when changing oil.
  2. Remove yellow cap from end of drain valve and install the drain tube onto the fitting.

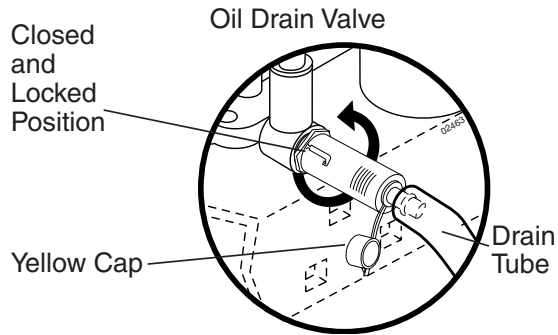

3. Unlock drain valve by pushing inward slightly and turning counterclockwise.
4. To open, pull out on the drain valve.
5. After oil has drained completely, close and lock the drain valve by pushing inward and turning clockwise until the pin is in the locked position as shown.
6. Remove the drain tube and replace the cap onto the end of the drain valve.
7. Refill engine with oil through oil fill dipstick tube. Pour slowly. Do not overfill. For approximate capacity see "PRODUCT SPECIFICATIONS" section of this manual.
8. Use gauge on oil fill cap/dipstick for checking level. For accurate reading, tighten dipstick cap securely onto the tube before removing dipstick. Keep oil at "FULL" line on dipstick. Tighten cap onto the tube securely when finished.

#### CLEAN AIR SCREEN

Air screen must be kept free of dirt and chaff to prevent engine damage from overheating. Clean with a wire brush or compressed air to remove dirt and stubborn dried gum fibers.

#### AIR FILTER

Your engine will not run properly using a dirty air filter. Service air cleaner more often under dusty conditions. See Engine Manual.

#### ENGINE OIL FILTER

Replace the engine oil filter every season or every other oil change if the tractor is used more than 100 hours in one year.

#### CLEAN AIR INTAKE/COOLING AREAS

To insure proper cooling, make sure the grass screen, cooling fins, and other external surfaces of the engine are kept clean at all times. Every 100 hours of operation (more often under extremely dusty, dirty conditions), remove the blower housing and other cooling shrouds. Clean the cooling fins and external surfaces as necessary. Make sure the cooling shrouds are reinstalled.

**NOTE:** Operating the engine with a blocked grass screen, dirty or plugged cooling fins, and/or cooling shrouds removed will cause engine damage due to overheating.

### MUFFLER

Inspect and replace corroded muffler and spark arrester (if equipped) as it could create a fire hazard and/or damage.

### SPARK PLUG(S)

Replace spark plug(s) at the beginning of each mowing season or after every 100 hours of operation, whichever occurs first. Spark plug type and gap setting are shown in "PRODUCT SPECIFICATIONS" section of this manual.

### IN-LINE FUEL FILTER

The fuel filter should be replaced once each season. If fuel filter becomes clogged, obstructing fuel flow to carburetor, replacement is required.

1. With engine cool, remove filter and plug fuel line sections.
2. Place new fuel filter in position in fuel line with arrow pointing towards carburetor.
3. Be sure there are no fuel line leaks and clamps are properly positioned.

4. Immediately wipe up any spilled gasoline.

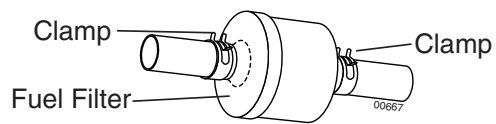

### CLEANING

- Clean engine, battery, seat, finish, etc. of all foreign matter.
- Keep finished surfaces and wheels free of all gasoline, oil, etc.
- Protect painted surfaces with automotive type wax.

We do not recommend using a garden hose or pressure washer to clean your tractor unless the engine and transmission are covered to keep water out. Water in engine or transmission will shorten the useful life of your tractor. Use compressed air or a leaf blower to remove grass, leaves and trash from tractor and mower.

## SERVICE AND ADJUSTMENTS



### WARNING: TO AVOID SERIOUS INJURY, BEFORE PERFORMING ANY SERVICE OR ADJUSTMENTS:

1. Depress clutch/brake pedal fully and set parking brake.
2. Place gearshift lever in neutral (N) position.
3. Place attachment clutch in "DISENGAGED" position.
4. Turn ignition key to "STOP" and remove key.
5. Make sure the blades and all moving parts have completely stopped.
6. Disconnect spark plug wire from spark plug and place wire where it cannot come in contact with plug.

### TRACTOR

#### TO REMOVE MOWER

Mower will be easier to remove from the right side of tractor.

1. Place attachment clutch switch in "DISENGAGED" position.
2. Move attachment lift lever forward to lower mower to its lowest position.

3. Roll belt off electric clutch pulley.
4. Disconnect anti-sway bar from chassis bracket by removing retainer spring.
5. Disconnect suspension arms from rear deck brackets by removing retainer springs.

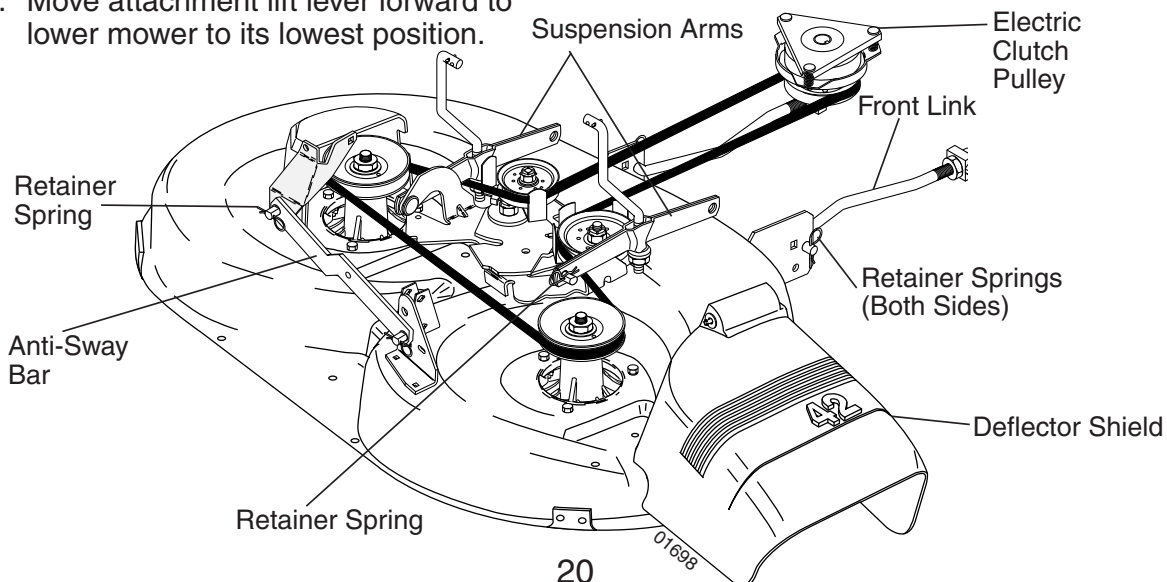



6. Disconnect front links from deck by removing retainer springs.
7. Raise lift lever to raise suspension arms. Slide mower out from under tractor.

**IMPORTANT:** If an attachment other than the mower deck is to be mounted on the tractor, remove the front links.

### TO INSTALL MOWER

1. Raise attachment lift lever to its highest position.
2. Slide mower under tractor with deflector shield to right side of tractor.
3. Lower lift lever to its lowest position.
4. Connect front links to mower deck and secure with retainer springs.
5. Connect suspension arms to rear deck brackets and secure with retainer springs.
6. Connect anti-sway bar to chassis bracket and secure with retainer spring.
7. Install belt into electric clutch pulley groove.

### TO LEVEL MOWER HOUSING

Adjust the mower while tractor is parked on level ground or driveway. Make sure tires are properly inflated (See "PRODUCT SPECIFICATIONS" section of this manual). If tires are over or underinflated, you will not properly adjust your mower.

### SIDE-TO-SIDE ADJUSTMENT

- Raise mower to its highest position.
- At the midpoint of both sides of mower, measure height from bottom edge of mower to ground. Distance "A" on both sides of mower should be the same or within 1/4" of each other.
- If adjustment is necessary, make adjustment on one side of mower only.
- To raise one side of mower, tighten lift link adjustment nut on that side.
- To lower one side of mower, loosen lift link adjustment nut on that side.

**NOTE:** Each full turn of adjustment nut will change mower height about 1/8".

- Recheck measurements after adjusting.

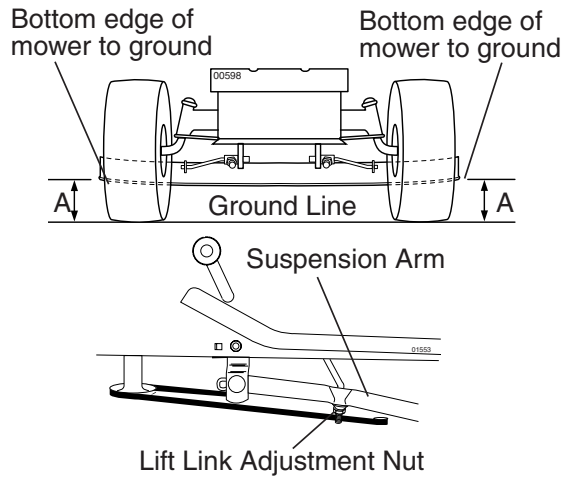

### FRONT-TO-BACK ADJUSTMENT

**IMPORTANT:** Deck must be level side-to-side. If the following front-to-back adjustment is necessary, be sure to adjust both front links equally so mower will stay level side-to-side. To obtain the best cutting results, the mower housing should be adjusted so that the front is approximately 1/8" to 1/2" lower than the rear when the mower is in its highest position.

Check adjustment on right side of tractor. Measure distance "D" directly in front and behind the mandrel at bottom edge of mower housing as shown.

- Before making any necessary adjustments, check that both front links are equal in length.
- If links are not equal in length, adjust one link to same length as other link.
- To lower front of mower loosen nut "E" on both front links an equal number of turns.
- When distance "D" is 1/8" to 1/2" lower at front than rear, tighten nuts "F" against trunnion on both front links.
- To raise front of mower, loosen nut "F" from trunnion on both front links. Tighten nut "E" on both front links an equal number of turns. The two front links must remain equal in length.
- When distance "D" is 1/8" to 1/2" lower at front than rear, tighten nut "F" against trunnion on both front links.
- Recheck side-to-side adjustment.

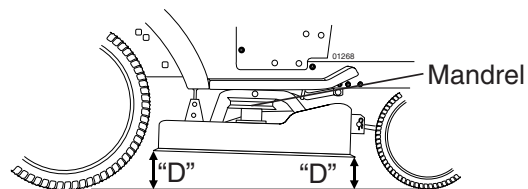

Both Front Links Should be Equal in Length

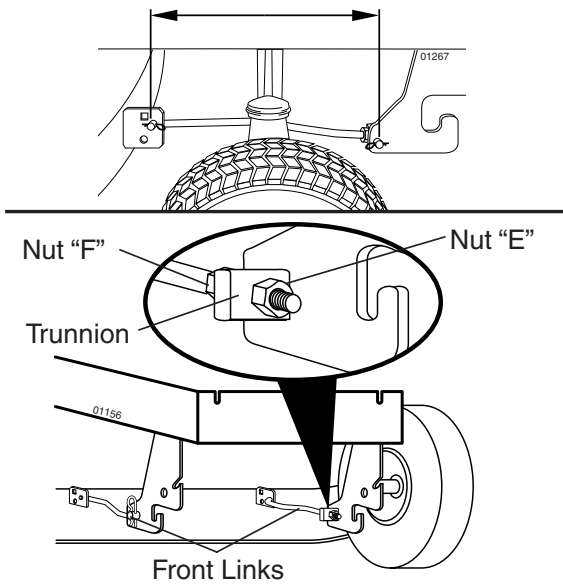

### TO REPLACE MOWER BLADE DRIVE BELT

The mower blade drive belt may be replaced without tools. Park the tractor on level surface. Engage parking brake.

#### BELT REMOVAL -

1. Remove mower from tractor (See "TO REMOVE MOWER" in this section of manual).
2. Work belt off both mandrel pulleys and idler pulleys.
3. Pull belt away from mower.

#### BELT INSTALLATION -

1. Work belt around both mandrel pulleys and idler pulleys
2. Make sure belt is in all pulley grooves and inside all belt guides.
3. Install mower (See "To Install Mower" in this section of this manual).

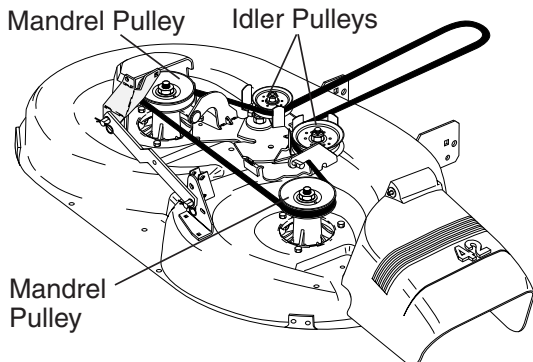

### TO CHECK AND ADJUST BRAKE

Your tractor is equipped with an adjustable brake system which is mounted on the right side of the transaxle. If tractor requires more than five (5) feet to stop at highest speed in highest gear on a level, dry concrete or paved surface, then brake must be checked and adjusted.

### TO CHECK BRAKE

1. Park tractor on a level, dry concrete or paved surface, depress clutch/brake pedal all the way down and engage parking brake.
2. Place gear shift lever in neutral (N) position.

The rear wheels must lock and skid when you try to manually push the tractor forward. If the rear wheels rotate, the brake needs to be adjusted or the pads need to be replaced.

### TO ADJUST BRAKE

1. Depress clutch/brake pedal all the way down and engage parking brake.
2. Measure distance between brake operating arm and nut "A" on brake rod.
3. If distance is other than 1-1/2", loosen jam nut and turn nut "A" until distance becomes 1-1/2". Retighten jam nut against nut "A".
4. Road test tractor for proper stopping distance as stated above. Readjust if necessary. If stopping distance is still greater than five (5) feet in highest gear, further maintenance is necessary. Contact an authorized service center/department.

With parking brake "Engaged"

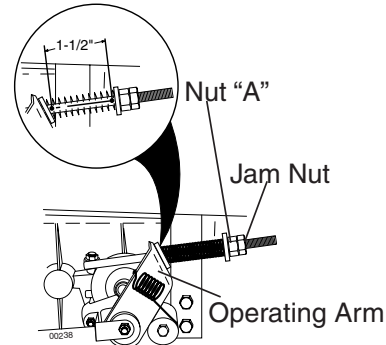

### TO REPLACE MOTION DRIVE BELT

Park the tractor on level surface. Engage parking brake. For assistance, there is a belt installation guide decal on bottom side of left footrest.

#### BELT REMOVAL -

1. Remove mower (See "TO REMOVE MOWER" in this section of manual).
- NOTE:** Observe entire motion drive belt and position of all belt guides and keepers.
2. Disconnect clutch wire harness.
3. Remove clutch locator.
4. Remove belt from stationary idler and clutching idler.
5. Remove belt downward from engine pulley and around electric clutch.
6. Pull belt slack toward rear of tractor. Remove belt upwards from transaxle pulley by deflecting belt keepers.
7. Remove belt from center span keeper and pull belt away from tractor.

### BELT INSTALLATION -

1. Carefully work new belt down between transaxle belt keepers and onto the input pulley.
2. Slide belt into the center span keeper.
3. Pull belt toward front of tractor and roll belt around electric clutch and onto engine pulley.
4. Install belt through stationary idler and clutching idler.
5. Reinstall clutch locator and tighten nut securely.
6. Reconnect clutch harness.
7. Make sure belt is in all pulley grooves and inside all belt guides and keepers.
8. Install mower (See "TO INSTALL MOWER" in this section of manual).

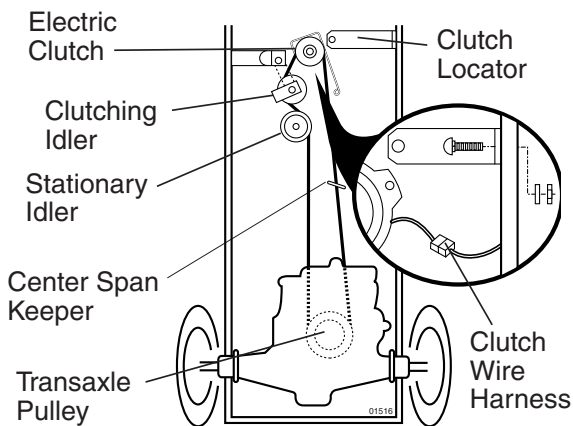

### TRANSAXLE GEAR SHIFT LEVER NEUTRAL ADJUSTMENT

The transaxle should be in neutral when the gear shift lever is in neutral (N) (lock gate) position. The adjustment is preset at the factory; however, if adjustment is needed, proceed as follows:

1. Make sure transaxle is in neutral (N).  
**NOTE:** When the tractor rear wheels move freely, the transaxle is in neutral.
2. Loosen adjustment bolt in front of the right rear wheel.
3. Position the gear shift lever in the neutral (N) position.
4. Tighten adjustment bolt securely.

**NOTE:** If additional clearance is needed to get to adjustment bolt, move mower deck height to the lowest position.

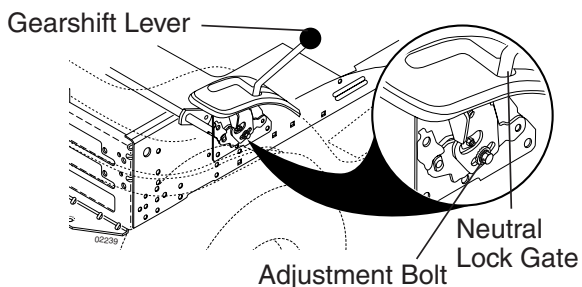

### TO ADJUST STEERING WHEEL ALIGNMENT

If steering wheel crossbars are not horizontal (left to right) when wheels are positioned straight forward, remove steering wheel and reassemble with crossbars horizontal. Tighten securely.

### FRONT WHEEL TOE-IN/CAMBER

The front wheel toe-in and camber are not adjustable on your tractor. If damage has occurred to affect the front wheel toe-in or camber, contact your nearest authorized service center/department.

### TO REMOVE WHEEL FOR REPAIRS

1. Block up axle securely.
2. Remove axle cover, retaining ring and washers to allow wheel removal (rear wheels have a square key - Do not lose).
3. Repair tire and reassemble.  
**NOTE:** On rear wheels only: align grooves in rear wheel hub and axle. Insert square key.
4. Replace washers and snap retaining ring securely in axle groove.
5. Replace axle cover.

**NOTE:** To seal tire punctures and prevent flat tires due to slow leaks, tire sealant may be purchased from your local parts dealer. Tire sealant also prevents tire dry rot and corrosion.

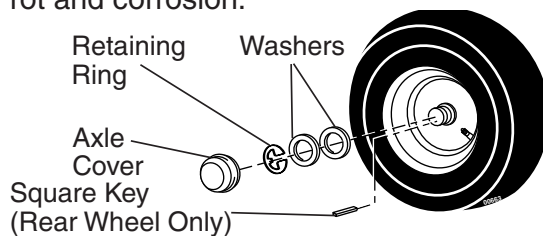

### TO START ENGINE WITH A WEAK BATTERY

**WARNING:** Lead-acid batteries generate explosive gases. Keep sparks, flame and smoking materials away from batteries. Always wear eye protection when around batteries.

If your battery is too weak to start the engine, it should be recharged. (See "BATTERY" in the MAINTENANCE section of this manual).

If "jumper cables" are used for emergency starting, follow this procedure:

**IMPORTANT:** Your tractor is equipped with a 12 volt system. The other vehicle must also be a 12 volt system. Do not use your tractor battery to start other vehicles.

### TO ATTACH JUMPER CABLES -

1. Connect one end of the RED cable to the POSITIVE (+) terminal of each battery(A-B), taking care not to short against tractor chassis.

2. Connect one end of the BLACK cable to the NEGATIVE (-) terminal (C) of fully charged battery.
3. Connect the other end of the BLACK cable (D) to good chassis ground, away from fuel tank and battery.

**TO REMOVE CABLES, REVERSE ORDER -**

1. BLACK cable first from chassis and then from the fully charged battery.
2. RED cable last from both batteries.

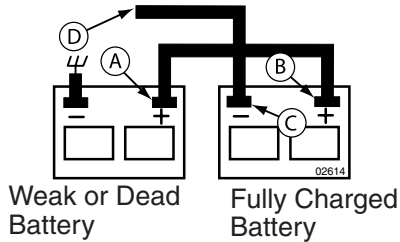

**REPLACING BATTERY**

**⚠ WARNING:** Do not short battery terminals by allowing a wrench or any other object to contact both terminals at the same time. Before connecting battery, remove metal bracelets, wristwatch bands, rings, etc.

Positive terminal must be connected first to prevent sparking from accidental grounding.

1. Lift hood to raised position.
2. Remove terminal guard.
3. Disconnect BLACK battery cable then RED battery cable and carefully remove battery from tractor.
4. Install new battery with terminals in same position as old battery.
5. Reinstall terminal guard.
6. First connect RED battery cable to positive (+) battery terminal with hex bolt and keps nut as shown. Tighten securely.
7. Connect BLACK grounding cable to negative (-) battery terminal with remaining hex bolt and keps nut. Tighten securely
8. Close terminal access doors.
9. Close hood.

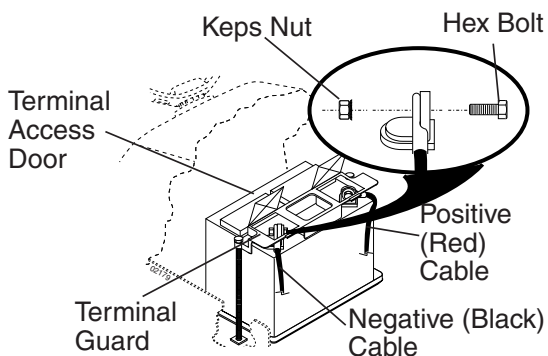

**TO REPLACE HEADLIGHT BULB**

1. Raise hood.
2. Pull bulb holder out of the hole in the backside of the grill.
3. Replace bulb in holder and push bulb holder securely back into the hole in the backside of the grill.
4. Close hood.

**INTERLOCKS AND RELAYS**

Loose or damaged wiring may cause your tractor to run poorly, stop running, or prevent it from starting.

- Check wiring. See electrical wiring diagram in the Repair Parts section.

**TO REPLACE FUSE**

Replace with 20 amp automotive-type plug-in fuse. The fuse holder is located behind the dash.

**TO REMOVE HOOD AND GRILL ASSEMBLY**

1. Raise hood.
2. Unsnap headlight wire connector.
3. Stand in front of tractor. Grasp hood at sides, tilt toward engine and lift off of tractor.
4. When replacing hood, be sure to re-connect the headlight wire connector.

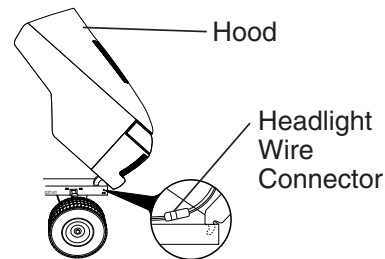

**ENGINE**

**TO ADJUST THROTTLE CONTROL CABLE**

The throttle control has been preset at the factory and adjustment should not be necessary. Check adjustment as described below before loosening cable. If adjustment is necessary, see engine manual

**TO ADJUST CARBURETOR**

The carburetor has been preset at the factory and adjustment should not be necessary. However, minor adjustment may be required to compensate for differences in fuel, temperature, altitude or load. If the carburetor does need adjustment, see engine manual.



## STORAGE

Immediately prepare your tractor for storage at the end of the season or if the tractor will not be used for 30 days or more.

**⚠ WARNING:** Never store the tractor with gasoline in the tank inside a building where fumes may reach an open flame or spark. Allow the engine to cool before storing in any enclosure.

### TRACTOR

Remove mower from tractor for winter storage. When mower is to be stored for a period of time, clean it thoroughly, remove all dirt, grease, leaves, etc. Store in a clean, dry area.

1. Clean entire tractor (See "CLEANING" in the Maintenance section of this manual).
2. Inspect and replace belts, if necessary (See belt replacement instructions in the Service and Adjustments section of this manual).
3. Lubricate as shown in the Maintenance section of this manual.
4. Be sure that all nuts, bolts and screws are securely fastened. Inspect moving parts for damage, breakage and wear. Replace if necessary.
5. Touch up all rusted or chipped paint surfaces; sand lightly before painting.

### BATTERY

- Fully charge the battery for storage.
- After a period of time in storage, battery may require recharging.
- To help prevent corrosion and power leakage during long periods of storage, battery cables should be disconnected and battery cleaned thoroughly (see "TO CLEAN BATTERY AND TERMINALS" in the Maintenance section of this manual).
- After cleaning, leave cables disconnected and place cables where they cannot come in contact with battery terminals.
- If battery is removed from tractor for storage, do not store battery directly on concrete or damp surfaces.

### ENGINE

#### FUEL SYSTEM

**IMPORTANT:** It is important to prevent gum deposits from forming in essential fuel system parts such as carburetor, fuel

hose, or tank during storage. Also, alcohol blended fuels (called gasohol or using ethanol or methanol) can attract moisture which leads to separation and formation of acids during storage. Acidic gas can damage the fuel system of an engine while in storage.

- Empty the fuel tank by starting the engine and letting it run until the fuel lines and carburetor are empty.
- Never use engine or carburetor cleaner products in the fuel tank or permanent damage may occur.
- Use fresh fuel next season.

**NOTE:** Fuel stabilizer is an acceptable alternative in minimizing the formation of fuel gum deposits during storage. Add stabilizer to gasoline in fuel tank or storage container. Always follow the mix ratio found on stabilizer container. Run engine at least 10 minutes after adding stabilizer to allow the stabilizer to reach the carburetor. Do not empty the gas tank and carburetor if using fuel stabilizer.

#### ENGINE OIL

Drain oil (with engine warm) and replace with clean engine oil. (See "ENGINE" in the Maintenance section of this manual).

#### CYLINDER(S)

1. Remove spark plug(s).
2. Pour one ounce of oil through spark plug hole(s) into cylinder(s).
3. Turn ignition key to start position for a few seconds to distribute oil.
4. Replace with new spark plug(s).

#### OTHER

- Do not store gasoline from one season to another.
- Replace your gasoline can if your can starts to rust. Rust and/or dirt in your gasoline will cause problems.
- If possible, store your tractor indoors and cover it to give protection from dust and dirt.
- Cover your tractor with a suitable protective cover that does not retain moisture. Do not use plastic. Plastic cannot breathe which allows condensation to form and will cause your tractor to rust.

**IMPORTANT:** Never cover tractor while engine and exhaust areas are still warm.

### TROUBLESHOOTING CHART

<b>PROBLEM</b>	<b>CAUSE</b>	<b>CORRECTION</b>
<b>Will not start</b>	<ol style="list-style-type: none"> <li>1. Out of fuel.</li> <li>2. Engine not "CHOKED" properly.</li> <li>3. Engine flooded.</li> <li>4. Bad spark plug.</li> <li>5. Dirty air filter.</li> <li>6. Dirty fuel filter.</li> <li>7. Water in fuel.</li> <li>8. Loose or damaged wiring.</li> <li>9. Carburetor out of adjustment.</li> <li>10. Engine valves out of adjustment.</li> </ol>	<ol style="list-style-type: none"> <li>1. Fill fuel tank.</li> <li>2. See "TO START ENGINE" in Operation section.</li> <li>3. Wait several minutes before attempting to start.</li> <li>4. Replace spark plug.</li> <li>5. Clean/replace air filter.</li> <li>6. Replace fuel filter.</li> <li>7. Empty fuel tank and carburetor, refill tank with fresh gasoline and replace fuel filter.</li> <li>8. Check all wiring.</li> <li>9. See "To Adjust Carburetor" in Service and Adjustments section.</li> <li>10. Contact a qualified service center/department.</li> </ol>
<b>Hard to start</b>	<ol style="list-style-type: none"> <li>1. Dirty air filter.</li> <li>2. Bad spark plug.</li> <li>3. Weak or dead battery.</li> <li>4. Dirty fuel filter.</li> <li>5. Stale or dirty fuel.</li> <li>6. Loose or damaged wiring.</li> <li>7. Carburetor out of adjustment.</li> <li>8. Engine valves out of adjustment.</li> </ol>	<ol style="list-style-type: none"> <li>1. Clean/replace air filter.</li> <li>2. Replace spark plug.</li> <li>3. Recharge or replace battery.</li> <li>4. Replace fuel filter.</li> <li>5. Empty fuel tank and refill tank with fresh, clean gasoline.</li> <li>6. Check all wiring.</li> <li>7. See "To Adjust Carburetor" in Service and Adjustments section.</li> <li>8. Contact a qualified service center/department.</li> </ol>
<b>Engine will not turn over</b>	<ol style="list-style-type: none"> <li>1. Clutch/brake pedal not depressed.</li> <li>2. Attachment clutch is engaged.</li> <li>3. Weak or dead battery.</li> <li>4. Blown fuse.</li> <li>5. Corroded battery terminals.</li> <li>6. Loose or damaged wiring.</li> <li>7. Faulty ignition switch.</li> <li>8. Faulty solenoid or starter.</li> <li>9. Faulty operator presence switch(es).</li> </ol>	<ol style="list-style-type: none"> <li>1. Depress clutch/brake pedal.</li> <li>2. Disengage attachment clutch.</li> <li>3. Recharge or replace battery.</li> <li>4. Replace fuse.</li> <li>5. Clean battery terminals.</li> <li>6. Check all wiring.</li> <li>7. Check/replace ignition switch.</li> <li>8. Check/replace solenoid or starter.</li> <li>9. Contact a qualified service center/department.</li> </ol>
<b>Engine clicks but will not start</b>	<ol style="list-style-type: none"> <li>1. Weak or dead battery.</li> <li>2. Corroded battery terminals.</li> <li>3. Loose or damaged wiring.</li> <li>4. Faulty solenoid or starter.</li> </ol>	<ol style="list-style-type: none"> <li>1. Recharge or replace battery.</li> <li>2. Clean battery terminals.</li> <li>3. Check all wiring.</li> <li>4. Check/replace solenoid or starter.</li> </ol>
<b>Loss of power</b>	<ol style="list-style-type: none"> <li>1. Cutting too much grass/too fast.</li> <li>2. Throttle in "CHOKE" position.</li> </ol>	<ol style="list-style-type: none"> <li>1. Raise cutting height/reduce speed.</li> <li>2. Adjust throttle control.</li> </ol>



**TROUBLESHOOTING CHART**

<b>PROBLEM</b>	<b>CAUSE</b>	<b>CORRECTION</b>
<b>Loss of power (continued)</b>	3. Build-up of grass, leaves and trash under mower. 4. Dirty air filter. 5. Low oil level/dirty oil. 6. Faulty spark plug.  7. Dirty fuel filter. 8. Stale or dirty fuel.  9. Water in fuel.  10. Spark plug wire loose.  11. Dirty engine air screen/fins. 12. Dirty/clogged muffler. 13. Loose or damaged wiring. 14. Carburetor out of adjustment.  15. Engine valves out of adjustment.	3. Clean underside of mower housing. 4. Clean/replace air filter. 5. Check oil level/change oil. 6. Clean and regap or change spark plug. 7. Replace fuel filter. 8. Empty fuel tank and refill tank with fresh, clean gasoline. 9. Empty fuel tank and carburetor, refill tank with fresh gasoline and replace fuel filter. 10. Connect and tighten spark plug wire. 11. Clean engine air screen/fins. 12. Clean/replace muffler. 13. Check all wiring. 14. See "To Adjust Carburetor" in Service and Adjustments section. 15. Contact a qualified service center/department.
<b>Excessive vibration</b>	1. Worn, bent or loose blade. 2. Bent blade mandrel. 3. Loose/damaged part(s).	1. Replace blade. Tighten blade bolt. 2. Contact a qualified service center/department. 3. Tighten loose part(s). Replace damaged parts.
<b>Engine continues to run when operator leaves seat with attachment clutch engaged</b>	1. Faulty operator-safety presence control system.	1. Check wiring, switches and connections. If not contact a qualified service center/department.
<b>Poor cut - uneven</b>	1. Worn, bent or loose blade. 2. Mower deck not level. 3. Buildup of grass, leaves, and trash under mower. 4. Bent blade mandrel.  5. Clogged mower deck vent holes from buildup of grass, leaves, and trash around mandrels.	1. Replace blade. Tighten blade bolt. 2. Level mower deck. 3. Clean underside of mower housing. 4. Contact a qualified service center/department. 5. Clean around mandrels to open vent holes.
<b>Mower blades will not rotate</b>	1. Obstruction in clutch mechanism. 2. Worn/damaged mower drive belt. 3. Frozen idler pulley. 4. Frozen blade mandrel.	1. Remove obstruction. 2. Replace mower drive belt. 3. Replace idler pulley. 4. Contact a qualified service center/department.

## TROUBLESHOOTING CHART

PROBLEM	CAUSE	CORRECTION
<b>Poor grass discharge</b>	<ol style="list-style-type: none"> <li>1. Engine speed too slow.</li> <li>2. Travel speed too fast.</li> <li>3. Wet grass.</li> <li>4. Mower deck not level.</li> <li>5. Low/uneven tire air pressure.</li> <li>6. Worn, bent or loose blade.</li> <li>7. Buildup of grass, leaves and trash under mower.</li> <li>8. Mower drive belt worn.</li> <li>9. Blades improperly installed.</li> <li>10. Improper blades used.</li> <li>11. Clogged mower deck vent holes from buildup of grass, leaves, and trash around mandrels.</li> </ol>	<ol style="list-style-type: none"> <li>1. Place throttle control in "FAST" position.</li> <li>2. Shift to slower speed.</li> <li>3. Allow grass to dry before mowing.</li> <li>4. Level mower deck.</li> <li>5. Check tires for proper air pressure.</li> <li>6. Replace/sharpen blade. Tighten blade bolt.</li> <li>7. Clean underside of mower housing.</li> <li>8. Replace mower drive belt.</li> <li>9. Reinstall blades sharp edge down.</li> <li>10. Replace with blades listed in this manual.</li> <li>11. Clean around mandrels to open vent holes.</li> </ol>
<b>Headlight(s) not working (if so equipped)</b>	<ol style="list-style-type: none"> <li>1. Switch is "OFF".</li> <li>2. Bulb(s) or lamp(s) burned out.</li> <li>3. Faulty light switch.</li> <li>4. Loose or damaged wiring.</li> <li>5. Blown fuse.</li> </ol>	<ol style="list-style-type: none"> <li>1. Turn switch "ON".</li> <li>2. Replace bulb(s) or lamp(s).</li> <li>3. Check/replace light switch.</li> <li>4. Check wiring and connections.</li> <li>5. Replace fuse.</li> </ol>
<b>Battery will not charge</b>	<ol style="list-style-type: none"> <li>1. Bad battery cell(s).</li> <li>2. Poor cable connections.</li> <li>3. Faulty regulator (if so equipped).</li> <li>4. Faulty alternator.</li> </ol>	<ol style="list-style-type: none"> <li>1. Replace battery.</li> <li>2. Check/clean all connections.</li> <li>3. Replace regulator.</li> <li>4. Replace alternator.</li> </ol>
<b>Engine "backfires" when turning engine "OFF"</b>	<ol style="list-style-type: none"> <li>1. Engine throttle control not set between half and full speed (fast) position before stopping engine.</li> </ol>	<ol style="list-style-type: none"> <li>1. Move throttle control between half and full speed (fast) position before stopping engine.</li> </ol>

## SUGGESTED GUIDE FOR SIGHTING SLOPES FOR SAFE OPERATION

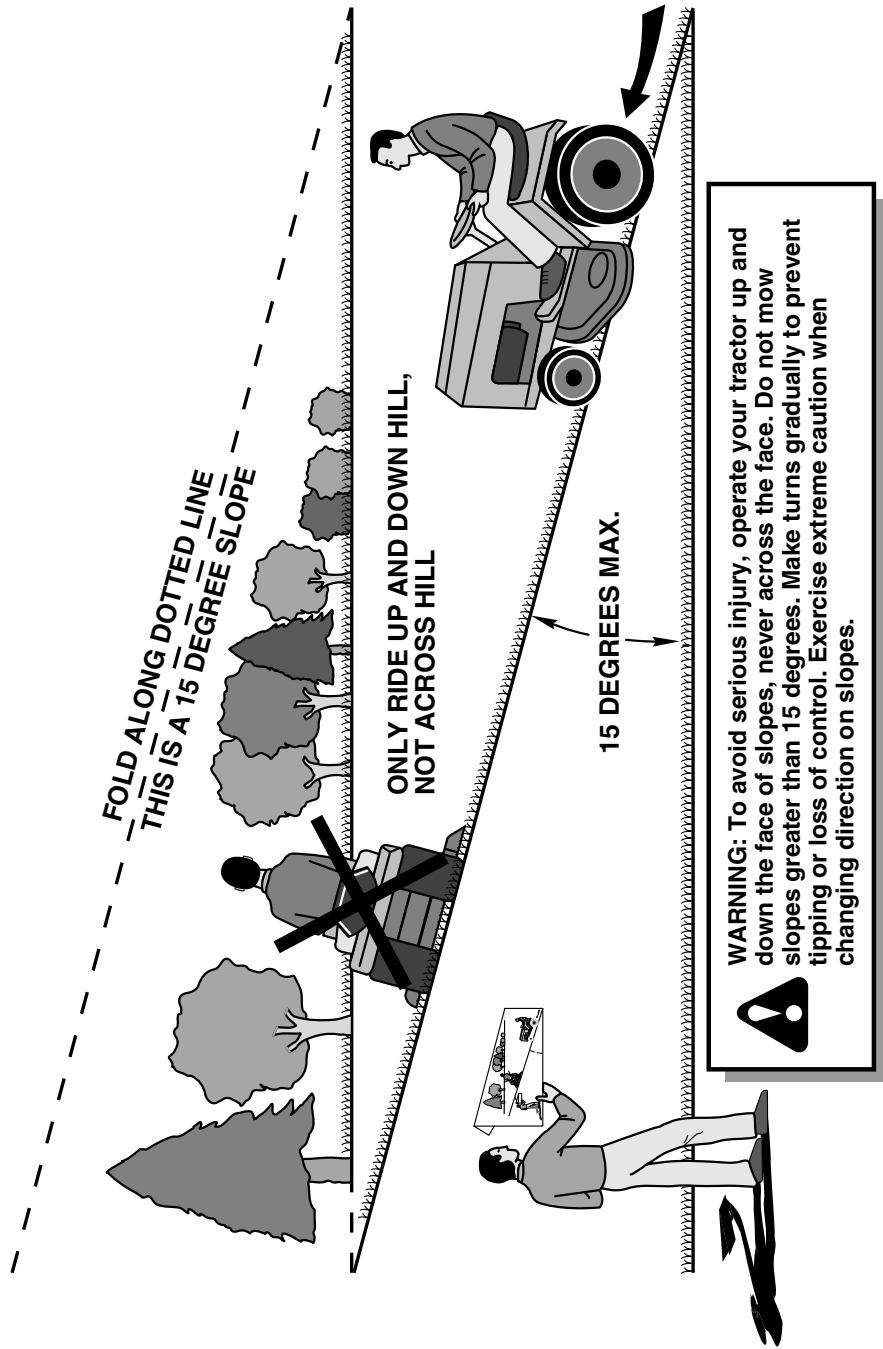

# Poulan PRO

www.mymowerparts.com