

For Parts Call 606-678-9623 or 606-561-4983



## Professional Shop Manual



### 2010 and Newer Log Splitter

**NOTE:** These materials are for use by trained technicians who are experienced in the service and repair of outdoor power equipment of the kind described in this publication, and are not intended for use by untrained or inexperienced individuals. These materials are intended to provide supplemental information to assist the trained technician. Untrained or inexperienced individuals should seek the assistance of an experienced and trained professional. Read, understand, and follow all instructions and use common sense when working on power equipment. This includes the contents of the product's Operators Manual, supplied with the equipment. No liability can be accepted for any inaccuracies or omission in this publication, although care has been taken to make it as complete and accurate as possible at the time of publication. However, due to the variety of outdoor power equipment and continuing product changes that occur over time, updates will be made to these instructions from time to time. Therefore, it may be necessary to obtain the latest materials before servicing or repairing a product. The company reserves the right to make changes at any time to this publication without prior notice and without incurring an obligation to make such changes to previously published versions. Instructions, photographs and illustrations used in this publication are for reference use only and may not depict actual model and component parts.

© Copyright 2010 MTD Products Inc. All Rights Reserved

For Parts Call 606-678-9623 or 606-561-4983

[www.mymowerparts.com](http://www.mymowerparts.com)

## Table of Contents

<b>Chapter 1: Introduction .....</b>	<b>1</b>
Professional Service Manual Intent .....	1
Safety .....	1
Fasteners .....	3
Assembly instructions .....	3
Description of the 2010 log splitters .....	3
Understanding model and serial numbers .....	4
<b>Chapter 2: Engine And Pump .....</b>	<b>5</b>
Horizontal shaft engines .....	5
Vertical shaft engines .....	7
Engine coupler gap .....	8
Pump removal/replacement .....	9
<b>Chapter 3: Hydraulic Diagnosis .....</b>	<b>11</b>
Overview .....	11
Understanding the hydraulic flow .....	12
Log splitter test procedures .....	16
What to do about failures .....	23
System drawings .....	24
Log Splitter Hydraulic System Work Sheet .....	29
<b>Chapter 4: Control Valve .....</b>	<b>31</b>
Control valve removal/replacement .....	31
Control valve spring cover .....	35
Control valve lever bracket .....	36
<b>Chapter 5: Cylinder .....</b>	<b>37</b>
Cylinder removal .....	37
Cylinder rebuilding .....	39
<b>Chapter 6: Wedge And Beam .....</b>	<b>47</b>
Wedge .....	47
Beam .....	48
<b>Chapter 7: Tank And Tires .....</b>	<b>51</b>
Tank .....	51
Wheel assembly .....	54
Fenders .....	55
Oil filter housing .....	57
Vertical locking rod .....	59
Horizontal locking rod .....	60

<b>Chapter 8: Maintenance</b> .....	<b>61</b>
Lubrication .....	61
Beam and wedge .....	61
Engine maintenance .....	62
Fuel system .....	62
Servicing the fuel system .....	62
Engine oil .....	63
Hydraulic oil .....	64
Wheel bearings .....	65

## CHAPTER 1: INTRODUCTION

### Professional Service Manual Intent

This Manual is intended to provide service dealers with an introduction to the mechanical aspects of the log splitters introduced for the 2010 model year.

- Detailed service information about the engine will be provided by the engine manufacturer, in most cases.

**Disclaimer:** The information contained in this manual is correct at the time of writing. Both the product and the information about the product are subject to change without notice.

About the text format:

**NOTE:** is used to point out information that is relevant to the procedure, but does not fit as a step in the procedure.

- Bullet points: indicate sub-steps or points.



Caution is used to point out potential danger to the technician, operator, bystanders, or surrounding property.



Warning indicates a potentially hazardous situation that, if not avoided, could result in death or serious injury.



Danger indicates an imminently hazardous situation that, if not avoided, will result in death or serious injury. This signal word is to be limited to the most extreme situations

1. Numbered steps indicate specific things that should be done, and the order in which they should be done.
  - 1a. Substeps will be lettered and nested within steps. Two or more substeps may be combined to describe the actions required to complete a step.

**Disclaimer:** This manual is intended for use by trained, professional technicians.

- Common sense in operation and safety is assumed.
- In no event shall MTD be liable for poor text interpretation or poor execution of the procedures described in the text.
- If the person using this manual is uncomfortable with any procedures they encounter, they should seek the help of a qualified technician or MTD Technical Support.

### Safety

This Service Manual is meant to be used along with the Operator's Manual. Read the Operator's Manual and familiarize yourself with the safety and operational instructions for the equipment being worked on. Keep a copy of the Operator's Manual for quick reference. Operator's manuals may be viewed for free at the brand support website. It will be necessary to have the complete model and serial number for the equipment.

2010 Log Splitters



- Be prepared in case of emergency:
  - Keep a fire extinguisher nearby
  - Keep a first aid kit nearby
  - Keep emergency contact numbers handy
- Replace any missing or damaged safety labels on shop equipment.
- Replace any missing or damaged safety labels on equipment being serviced.



- Grooming and attire:
  - Do not wear loose fitting clothing that may become entangled in equipment.
  - Long hair should be secured to prevent entanglement in equipment.
  - Jewelry is best removed.
- Protective gear: includes, but is not limited to
  - Clear eye protection ..... while working around any machinery
  - Protective gloves ..... where necessary
  - Armored footwear ..... when working around any machinery
  - Hearing protection ..... in noisy environments
  - Chemically resistant gloves ..... when working with chemicals or solvents
  - Respirator ..... when working with chemical or solvents
  - Appropriate tinted eye protection..... when cutting or welding
  - Flame resistant headgear, jacket, chaps . when cutting or welding



- Remember that some hazards have a cumulative effect. A single exposure may cause little or no harm, but continual or repeated exposure may cause very serious harm.
- Clean spills and fix obviously dangerous conditions as soon as they are noticed.
- Lift and support heavy objects safely and securely.
- Be aware of your surroundings and potential hazards that are inherent to all power equipment. All the labels in the world cannot protect a technician from an instant of carelessness.



- Exhaust fumes from running engines contain carbon monoxide (CO). Carbon monoxide is a colorless odorless gas that is fatal if inhaled in sufficient quantity. Only run engines in well ventilated areas. If running engines indoors, use an exhaust evacuation system with adequate make-up air ventilated into the shop.
- Hydraulic fluid under high pressure can be dangerous. A high-pressure hydraulic fluid leak or spray can penetrate the skin. If this happens, seek immediate medical attention to reduce the risk of blood poisoning leading to death or limb amputation.

### Fasteners

- Most of the fasteners used on these log splitters are sized in fractional inches. The engine fasteners are metric. For this reason, wrench sizes are frequently identified in the text, and measurements are given in U.S. and metric scales.
- If a fastener has a locking feature that has worn, replace the fastener or apply a small amount of releasable thread locking compound such as Loctite® 242 (blue).
- Some fasteners, like cotter pins, are single-use items that are not to be reused. Other fasteners such as lock washers, retaining rings, and internal cotter pins (hairpin clips) may be reused if they do not show signs of wear or damage. This manual leaves that decision to the judgement of the technician.

### Assembly instructions

- **Torque specifications** may be noted in the part of the text that covers assembly. They may be summarized in tables along with special instructions regarding locking or lubrication. Whichever method is more appropriate will be used. In many cases, both will be used so that the manual is handy as a quick-reference guide as well as a step-by-step procedure guide that does not require the user to hunt for information.
- **Lubricant** quantity and specification may be noted in the part of the text that covers maintenance, and again in the section that covers assembly. They may also be summarized in tables along with special instructions. Whichever method is more appropriate will be used. In many cases, the information will be found in several places in the manual so that the manual is handy as a quick-reference guide as well as a step-by-step procedure guide that does not require the user to hunt for information.
- The level of assembly instructions provided will be determined by the complexity of reassembly, and by the potential for damage or unsafe conditions to arise from mistakes made in assembly.
- Some instructions may refer to other parts of the manual for subsidiary procedures. This avoids repeating the same procedure two or three times in the manual.

### Description of the 2010 log splitters



Figure 1.1

For the 2010 model year, MTD re-designed its log splitter line.

The re-designed models can be identified by:

	2009 and older	2010
Beam	I-beam style	U-channel with a fabricated top plate
Wedge	Adjustable gibs	No gibs
Fittings	NPT	O-ring face





## CHAPTER 2: ENGINE AND PUMP

MTD log splitters are available with a variety of horizontal and vertical shaft engines. This manual covers procedures that are the same for all engine models available. Specific engine procedures are covered in the engine's service manual.

### Horizontal shaft engines

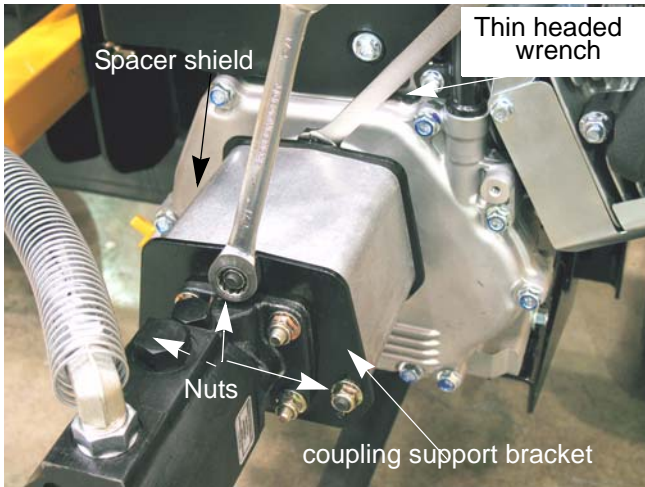

Figure 2.1

To remove/replace the engine:

1. Remove the three coupling support bracket nuts using a pair of 1/2" wrenches. See Figure 2.1.

**NOTE:** A thin headed wrench (like a tappet wrench) is needed to fit between the engine and the coupling support bracket.

2. Slide the pump and the coupling support bracket off as one assembly.

**NOTE:** support the pump. DO NOT let the pump hang by the hoses.

3. Remove the spider from the engine coupling.
4. Remove the spacer shield.

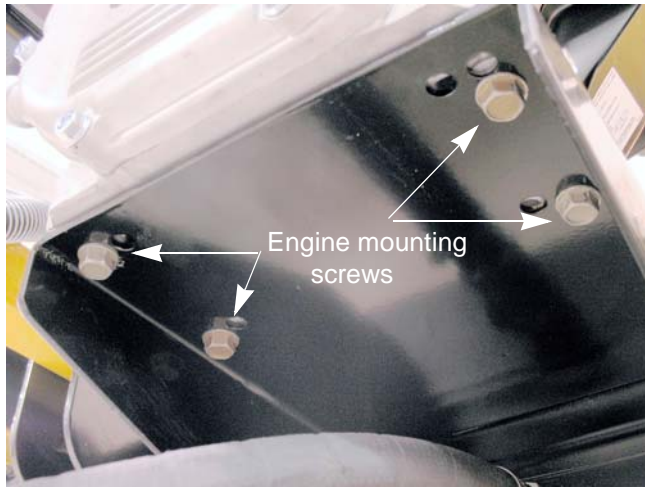

Figure 2.2

5. Remove the four engine mounting screws using a 9/16" wrench.
6. Remove the engine from the log splitter.

## 2010 Log Splitters

**NOTE:** If the engine is not being replaced, skip to step 10.

7. Remove the set screw in the engine coupling using a 1/8" hex key. See Figure 2.3.

**NOTE:** When installing the engine coupling, apply a small amount of releasable thread locking compound such as Loctite® 242 (blue) to the set screw and tighten it to a torque of 78 in lbs (9 Nm)

8. Remove the engine coupling and key.

**NOTE:** If the pump shows any signs of an impact, check the coupling support bracket. If the bracket is bent, replace the bracket and the bolts. A bent bracket or bolts may put a side load on the pump input shaft, damaging the bearings.

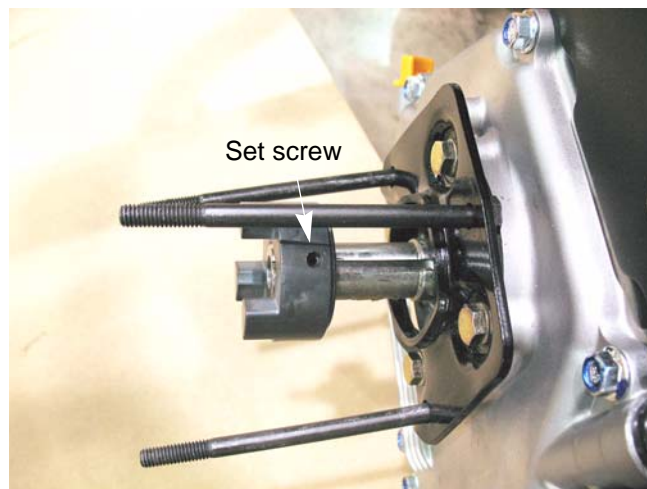

Figure 2.3

9. Remove the front coupling support bracket using a 1/2" wrench. See Figure 2.4.

10. Install the engine by following the previous steps in reverse order.

**NOTE:** The three long bolts must be in the front coupling support bracket before it is attached to the engine.

**NOTE:** Tighten the engine mounting screws to a torque of 325 - 450 in lbs (37 - 51 Nm).

11. Adjust the engine coupler gap by following the steps described in the engine coupler gap section of this chapter.

12. Test run the log splitter before returning it to service.

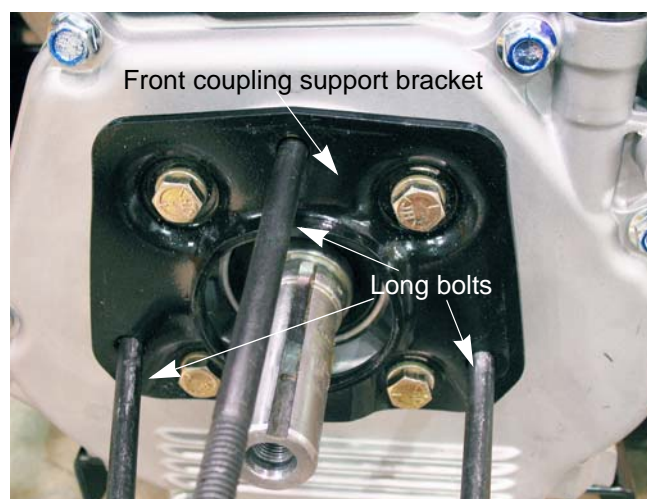

Figure 2.4

Vertical shaft engines

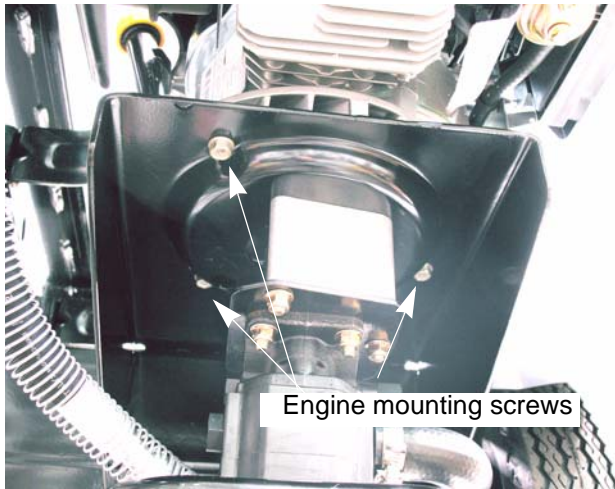

Figure 2.5

To remove/replace the engine:

1. Remove the three engine mounting screws using a 1/2" wrench.
  2. Remove the engine from the log splitter.
- NOTE:** If the engine is being replaced, continue to step 3.
3. Remove the set screw in the engine coupling using a 1/8" hex key.
  4. Remove the engine coupling and key.

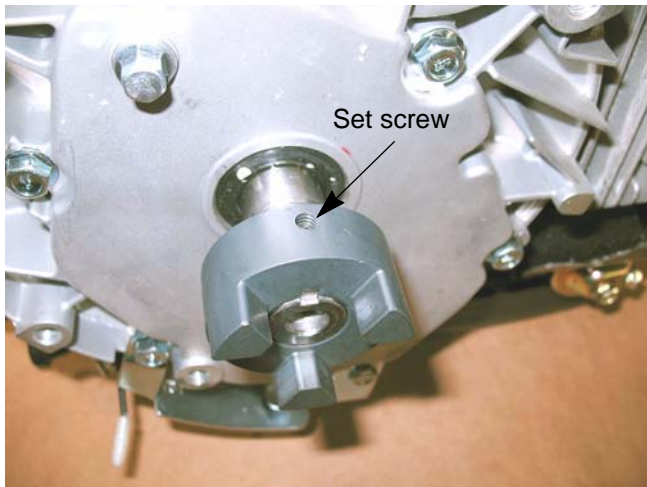

Figure 2.6

To install a vertical shaft engine:

1. Install the spider in the pump coupler half.
  2. Install the key in the crankshaft's keyway.
  3. Slide the engine coupler half onto the crankshaft.
- NOTE:** The end of the crankshaft should be flush with the coupling half. See Figure 2.6.
4. Apply a small amount of releasable thread locking compound such as Loctite® 242 (blue) to the set screw.
  5. Install the set screw and tighten it to a torque of 78 in lbs (9 Nm).

**NOTE:** If installing a new engine, Thread the self tapping screws into the engine mounting holes to cut the threads, then remove them.

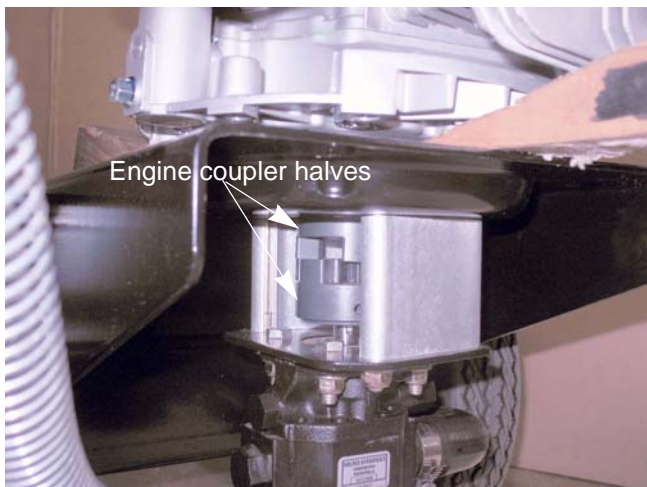

Figure 2.7

6. Hold the engine over the engine mount and pump assembly.
  7. Align the engine coupler halves. See Figure 2.6.
- NOTE:** The wooden wedges were used to hold the engine for the picture. They are not needed for this step.
8. Lower the engine onto the engine mount.
  9. Install the engine mounting screws and tighten them to a torque of 325 - 450 in lbs (37 - 51 Nm).
  10. Adjust the engine coupler gap by following the steps described in the engine coupler gap section of this chapter.
  11. Test run the log splitter before returning it to service.

## 2010 Log Splitters

### Engine coupler gap

MTD uses jaw type couplers to connect the engine to the pump. Jaw type couplers are made of three parts; two metallic coupler halves and a polymer spacer referred to as a spider. This type of coupling will isolate the engine vibration from the pump. It also compensates for minor pump mis-alignments.

The coupler must have a gap of 0.010" to 0.060" (0.25 - 1.5 mm) between the two metal halves in order to isolate the pump from the engine vibrations. To set the gap:

1. Inspect the spider for signs of damage or wear.  
**NOTE:** If the spider has signs of wear or damage the pump must be removed to replace the spider.
2. Remove the set screw from the pump coupler half. See Figure 2.8.

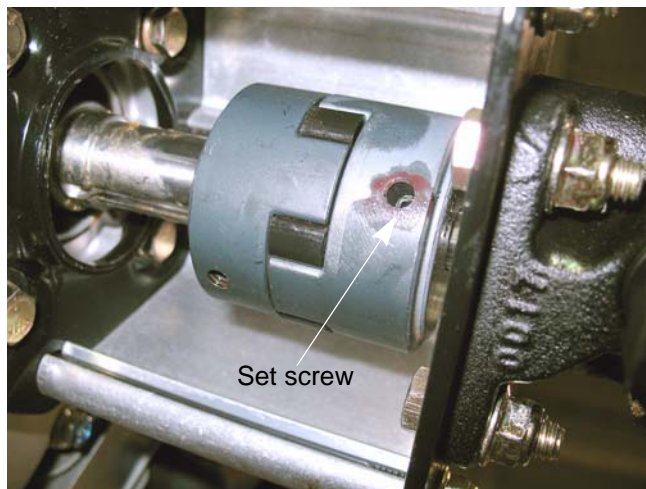

Figure 2.8

1. Insert a 0.010" to 0.060" (0.25 - 1.5 mm) feeler gauge between the coupler halves. See Figure 2.9.
2. Adjust the pump coupler half until there is a slight drag on the feeler gauge.
3. Apply a small amount of releasable thread locking compound such as Loctite® 242 (blue) to the set screw.
4. Install the set screw and tighten it to a torque of 78 in lbs (9 Nm).
5. Test run the log splitter in a safe area before returning it to service.

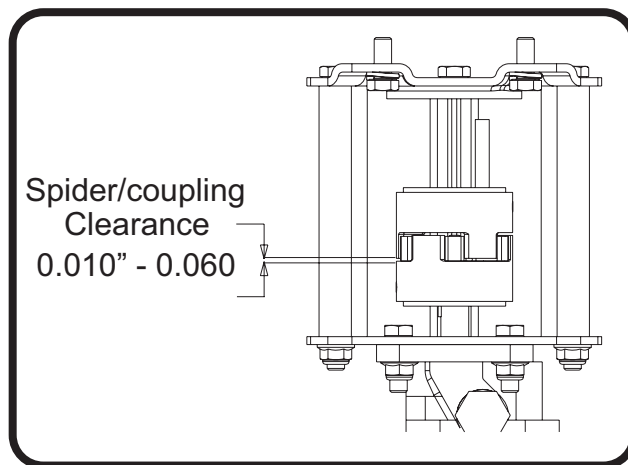
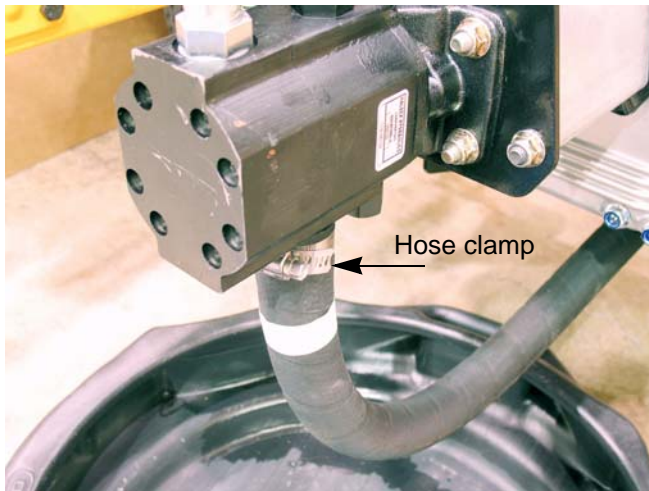

Figure 2.9

**Pump removal/replacement**



**Figure 2.10**

To remove the pump:

1. Place a suitable container, large enough to hold all of the fluid in the reservoir under the pump.

**NOTE:** On models with a vertical shaft engine, remove the engine by following the procedures described in the vertical shaft engine section of this chapter.

2. Loosen the hose clamp that secures the suction hose to the pump. See Figure 2.10.
3. Remove the suction hose and drain the fluid into the container that was placed under the pump.

**NOTE:** The suction hose is steel reinforced. Trying to clamp off the hose can result in damage to the hose.

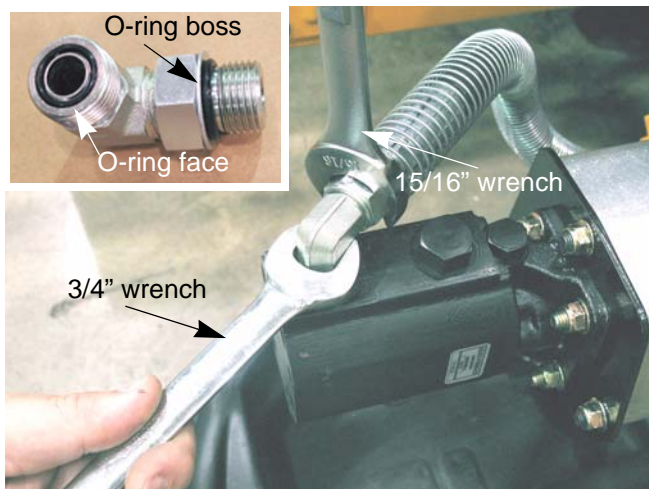

**Figure 2.11**

4. Remove the high pressure hose from the pump using a 3/4" wrench and a 15/16" wrench. See Figure 2.11.

**NOTE:** The elbow fitting on the discharge side of the pump has an O-ring boss on the side that goes into the pump. When installing the fitting, loosely thread it in until it is in the correct alignment. Then tighten the jam nut to compress the O-ring, providing the seal. See Figure 2.11. Inset.

**NOTE:** The side of the elbow fitting that the high pressure hose connects to has an O-ring face. Inspect the O-ring, part number #721-04411, before installing the hose on re-assembly. A damaged O-ring can cause fluid to leak out and/or air to be sucked into the system.



**Figure 2.12**

5. Remove the three coupling support bracket nuts using a 1/2" wrench. See Figure 2.12.
6. Slide the pump and the coupling support bracket off as one assembly.

## 2010 Log Splitters

7. Remove the set screw that secures the pump coupling half using a 1/8" hex key. See Figure 2.13.
8. Remove the coupling and the key.
9. Remove the four nuts and bolts that attach the coupling support bracket to the pump using a pair of 1/2" wrenches. See Figure 2.13.
10. Install the pump by following the previous steps in reverse order.

**NOTE:** DO NOT use teflon tape on any fitting on an MTD log splitter. Pieces of the tape can get into the system and damage the valve or the pump.

**NOTE:** Apply a light coat of oil to the O-rings before re-assembly.

**NOTE:** When tightening hoses with O-ring face fittings, hold the hose so that the center part of it does not rotate against the O-ring while the swivel section is tightened. If the center part rotates, the O-ring can be damaged and it will leak under pressure.

11. Set the engine coupling gap by following the steps described in the engine coupling gap section of this chapter.
12. Fill the reservoir with oil.
13. Disconnect and ground the spark plug wire.
14. Pull over the engine 12 times to prime the pump.
15. Connect the spark plug wire and start the engine.
16. Cycle the log splitter through its full travel 12 times to bleed the system.
17. Test run the log splitter before returning it to service.



**Figure 2.13**

## CHAPTER 3: HYDRAULIC DIAGNOSIS

### OVERVIEW

The main components of the log splitter are all fairly expensive. Hip-shot diagnosis will result in wasted time and money for the dealer. Throwing wrong parts at a log splitter gets expensive fast.

Troubleshooting is a process of developing and testing theories about the problem that caused the customer to bring the log splitter in for repair.

To properly diagnose a problem with the hydraulic system of a log splitter;

1. Get complete information from the customer;
  - 1a. Make sure the customer understands how to operate the log splitter.
  - 1b. Make sure the customer knows what the log splitter is supposed to be able to do.
  - 1c. Get a thorough description of the problem the customer is having with the equipment
  - 1d. Get as much maintenance history of the log splitter as possible.
2. Understand the equipment;
  - 2a. Know how each component works in the system.
  - 2b. Know what symptoms each component might produce if it fails.
  - 2c. Test the components against their specifications to identify the problem.
3. Use your understanding of the equipment to work in a logical sequence; See Figure 3.1.
  - 3a. Check the simple stuff first.
  - 3b. Use symptoms to focus your attention.
  - 3c. Test and eliminate theories.

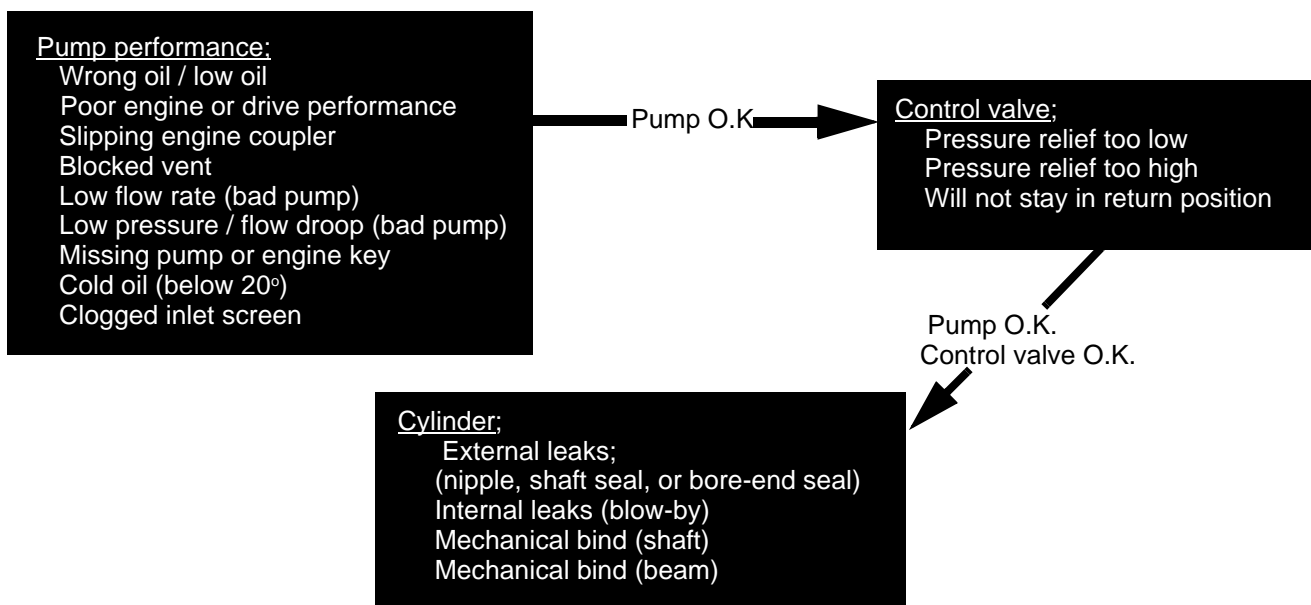

Figure 3.1

## 2010 Log Splitters

### Understanding the hydraulic flow

It starts at the **reservoir** (tank). See Figure 3.2.

- The tank acts as the axle of the log splitter.
- Check the level of the hydraulic fluid, and add hydraulic fluid through the oil fill port.
- The tank is vented by a passage drilled through the pipe plug. See Figure 3.2.

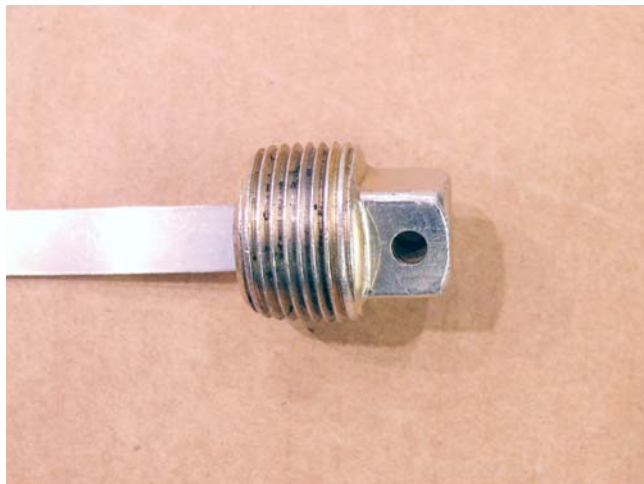

Figure 3.2

- The outlet on the engine side of the tank feeds hydraulic fluid directly to the pump. See Figure 3.3.
- The filter housing mounted on the tank provides a return path to the tank.

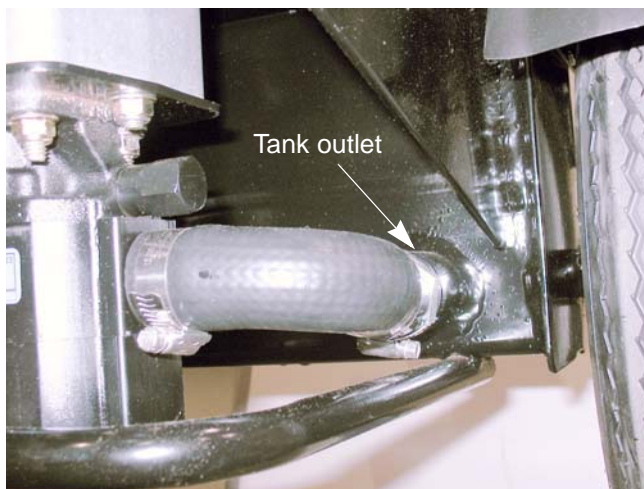

Figure 3.3



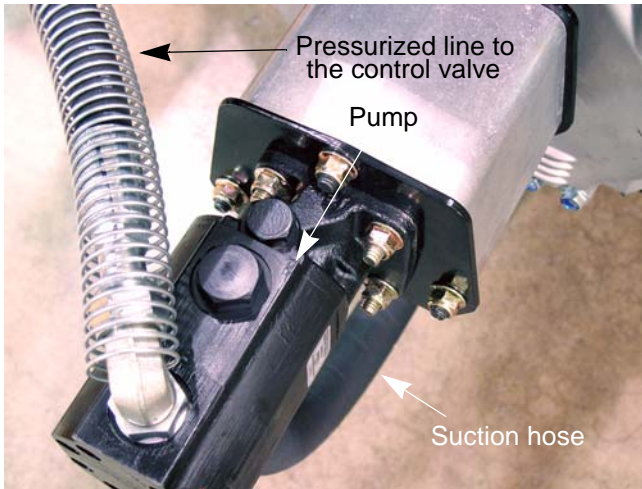

Figure 3.4

The **pump** draws fluid from the tank, and forces it under pressure to the control valve. See Figure 3.4.

- The pump is capable of producing 3,400 PSI (234 bar) at a pump speed of 3,500 RPM.
- The pump is a two-stage pump.
- There is no relief valve in the pump.
- There is unloading or by-pass valve in the volume circuit.
- The pump is direct-driven from the engine.
- The pump delivers pressurized hydraulic fluid to the control valve.

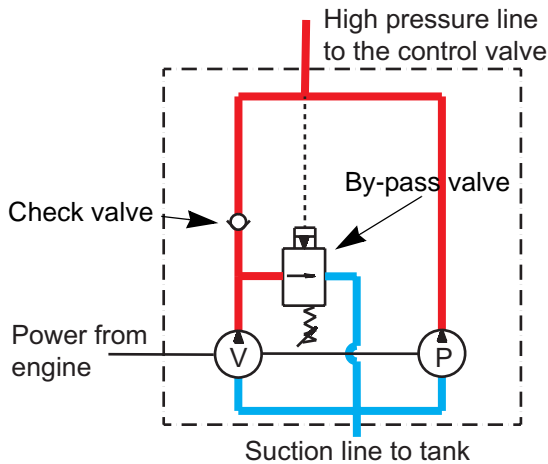

Figure 3.5

Two-stage pumps operate in a volume and a pressure mode.

In the **volume** mode both stages are pumping fluid to the control valve. The volume mode is used to rapidly move the wedge down the beam.

**NOTE:** The pressure stage flow is at a much lower GPM rating than the volume stage, but the pressure is much higher.

In the **pressure** mode, the pressure of the fluid from the pressure stage closes the check valve. The fluid coming out of the volume stage can not open the check valve and is diverted to the by-pass valve which will dump the fluid to the intake side of the pump.

The pressure mode is used to drive the wedge through the wood that is being split.

### Pump By-pass Settings

Pump	Tonnage	By-pass Pressure ± 100 PSI
718-04127	21,25 and 27	500 (34 bar)
718-04729	27 ton HP pump	1000 (69 bar)
718-04128	33	700 (48 bar)

## 2010 Log Splitters

The open-center **control valve** does four things: See Figure 3.6.

### 1. Regulate:

It regulates fluid pressure.

- If the pressure exceeds a pre-set limit, the relief valve opens, returning fluid directly to the tank.
- In any no-load condition, pressure should not exceed 300 PSI (20 BAR).

### 2. Forward:

It drives the ram toward the base plate.

- In the forward position, the control valve directs pressurized fluid through the hose to the port at the rear of the cylinder.
- This drives the piston up the bore, displacing fluid from the shaft side of the cylinder.
- The control valve allows displaced fluid to leave the shaft end of the cylinder through the trunnion, returning to the control valve.
- The control valve dumps displaced fluid back into the tank through the low pressure hose.

### 3. Retract:

It draws the ram away from the base plate.

- In the retract position, the control valve sends fluid through the trunnion it is mounted to, to the shaft side of the cylinder.
- This drives the piston down the bore, displacing fluid from the base side of the cylinder.
- The control valve allows displaced fluid to leave the base end of the cylinder through the high pressure hose, returning to the control valve.
- The control valve dumps displaced fluid back into the tank through the low pressure hose.
- The control lever is held in the retract position by a detent. When the piston bottoms-out, the build-up of pressure of between 500 and 2,000 PSI forces the valve out of detent, returning it to neutral.

### 4. Neutral:

In the neutral position, fluid from the pump is dumped directly back into the tank through the low pressure hose.

### Relief Valve Settings

Valve part number	Tonnage	Relief valve setting ± 100
718-04706	27 and 33	3400 PSI (234 bar)
718-04739	21	2700 PSI (186 bar)
718-04740	25	3200 PSI (221 bar)

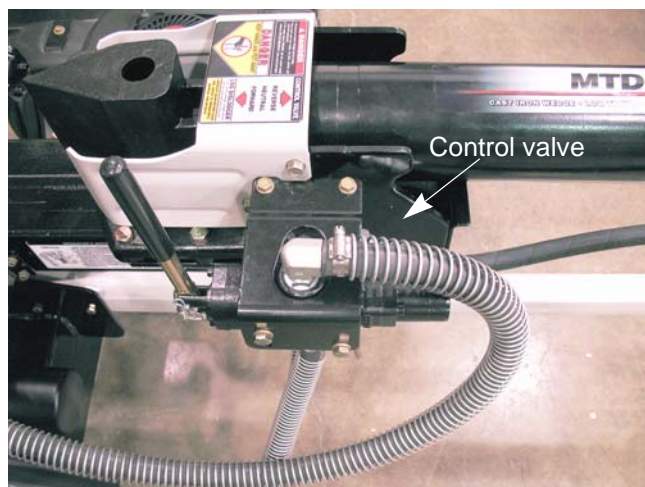

Figure 3.6

## Hydraulic Diagnosis

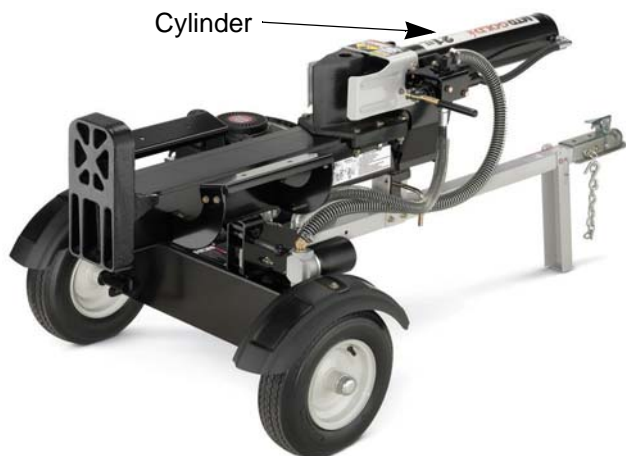

Figure 3.7

The **Cylinder** See Figure 3.7.

- Both ports of the cylinder are connected to the control valve.
- When pressure is applied to the port at the base of the cylinder (through the flexible high-pressure hose), the ram extends.
- When pressure is applied to the shaft end of the cylinder (through the trunnion), the ram retracts.
- When pressure is applied to one port, fluid from the other port is forced back to the control valve by the movement of the piston in the cylinder bore.

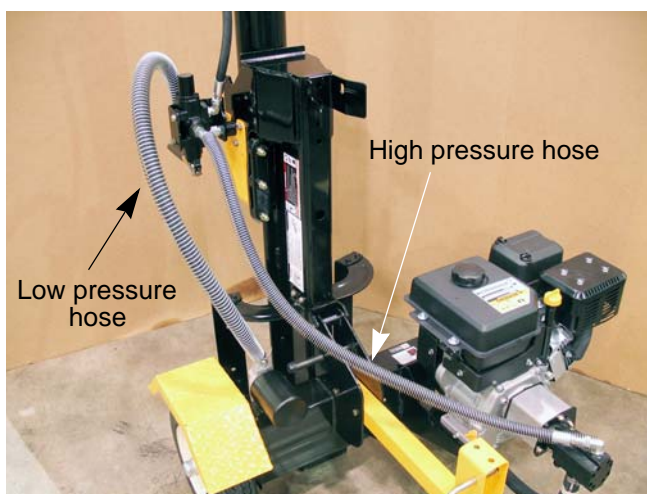

Figure 3.8

The **Hoses:**

The high pressure hoses:

- **High-pressure** hoses connect the pump to the control valve and the control valve to the base of the cylinder.
- High pressure means 3,400 PSI ( $\pm$  100) working pressure.

The low pressure hoses:

- **Low pressure** hoses connect the tank to the pump and the control valve to the tank.
- Hoses must not collapse under the suction pressure to the pump.
- Low pressure hoses are fastened with hose clamps.

**NOTE:** The low pressure hose that supplies the pump carries fluid under vacuum. If it leaks, it will draw-in air, but may leak very little fluid out. This entrapped air will create cavitation in the pump. Poor pump performance accompanied by whining or growling noises can indicate a leaky suction-side hose.

**NOTE:** The pressure of the fluid in the low pressure hose that runs from the control valve to the tank can be approximately 300 PSI.

## 2010 Log Splitters

### Log splitter test procedures

#### 1. Preparation

Troubleshooting and diagnosing a hydraulic system is a process that should be performed in a specific order. This chapter is laid out in the order the tests should be performed to get the best results.

**NOTE:** There is a hydraulic system testing work sheet at the end of this chapter. The work sheet is designed to assist in troubleshooting the hydraulic system. When performing warranty repairs, the work sheet must be turned in with the failed part(s). Before starting any testing of the log splitter, record the model number, serial number, pump model number and the valve model number on the worksheet. This information will be needed during the testing.

Just because a hydraulic pump is not pumping well does not mean the pump is bad. Before condemning parts or getting into deeper diagnosis, check the basics.

External factors that will effect pump performance include:

- A. Engine coupler: See Figure 3.9.
- Check for a worn spider.
  - Check for a sheared or missing key.
  - Check for a loose set screw that will allow the coupler to spin on the crankshaft or the pump shaft.

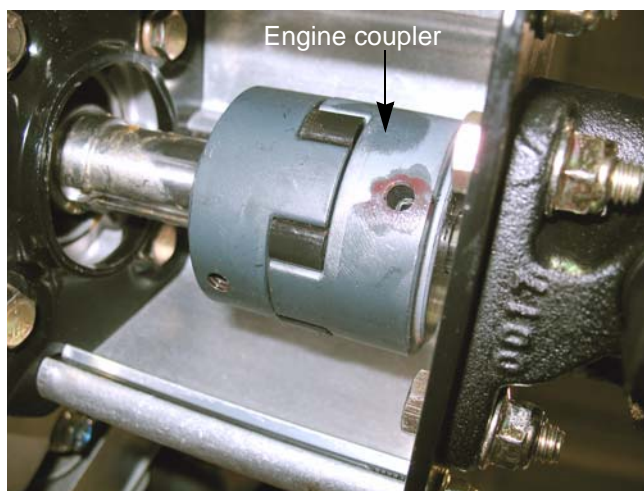

Figure 3.9

- B. Leaking fitting: See Figure 3.10.

- Damaged O-ring
- Mis-aligned O-ring
- Missing O-ring

**NOTE:** The fitting may not be leaking fluid, but sucking in air. This can cause sluggish operation.

**NOTE:** When tightening hoses with O-ring face fittings, hold the hose so that the center part of it does not rotate against the O-ring while the swivel part rotates. If the center part rotates, the O-ring can be damaged and it will leak under pressure.

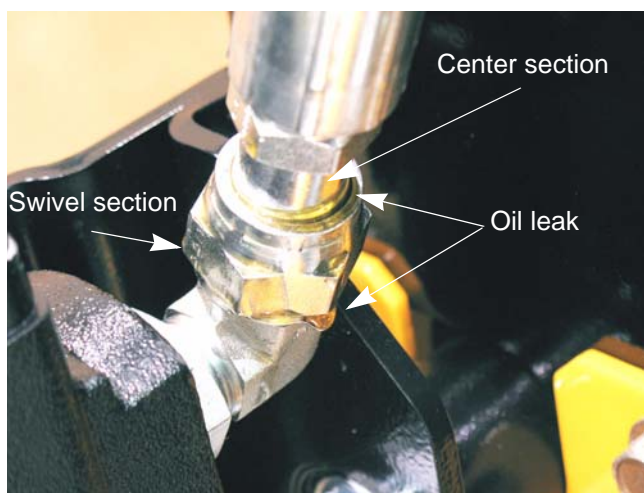

Figure 3.10

## Hydraulic Diagnosis

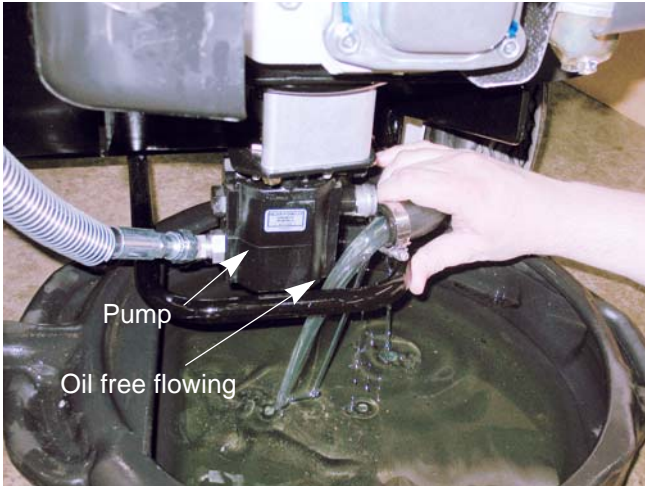

Figure 3.11



Figure 3.12

- C. Fluid not getting to the pump See Figure 3.11.
- If fluid is not reaching the pump, the log splitter will not work
  - Continued running with a dry pump will destroy the pump. This is not warrantable damage.
  - To check the fluid supply to the pump:
    - a. Place a drain pan under the pump.
    - b. Disconnect the suction hose from the pump.
    - c. Fluid should flow freely from it.
  - Watch the hose that feeds the pump while the ram is in motion. If the hose is collapsing, it will block-off the supply of fluid to the pump.
  - Entrained air from a suction hose leak will cause a loss of splitting force and a noisy pump.

- D. Low fluid / wrong fluid: See Figure 3.12.
- With the log splitter on level ground, remove the dipstick from the tank to check the fluid.
  - Check fluid cold. It expands when it gets hot.
  - Read the fluid level on the dipstick.
  - The reservoir will hold 3 or 5 gallons depending on the model.
  - Use either Dexron III ATF or SAE 10WAW (ISO 32 viscosity grade) hydraulic fluid. Do not mix the two.
- NOTE:** Models that are produced pre-filled, are filled with 10WAW (ISO 32).

- If in doubt, drain it out; replace the fluid with known correct hydraulic fluid.
- Too little fluid will starve the pump.
- Too much fluid will slow performance and spill from the vent.



Hot hydraulic fluid can cause burns. Do not check the fluid until the hydraulic system has cooled to ambient temperature after use.

- E. Cold temperatures
- Hydraulic fluid gets thick at low temperatures; the splitter should not be used with hydraulic fluid temperature below 20° F. (-6.66° C.)
  - Hydraulic tests should be performed with the fluid warmed-up to 120° F. (49° C.) to get accurate results.
  - When the fluid is too cold, pressure will be high and flow will be low.
  - When the fluid is too cold, log splitter operation will be sluggish.

## 2010 Log Splitters

F. Inspect the tank vent: See Figure 3.13.

- The tank vent is drilled through the pipe plug.
- As the fluid moves from the tank to the cylinder, it draws air in. As fluid moves from the cylinder back to the tank, air is forced out of the tank.
- If the tank cannot “breathe” through the vent, extending the ram will form a vacuum in the tank.
- If the tank cannot “breathe” through the vent, retracting the ram will pressurize the tank.
- The ram will move through part of its’ stroke, then stop as the vacuum or pressure builds.
- The vent also allows for the thermal expansion of the hydraulic fluid.

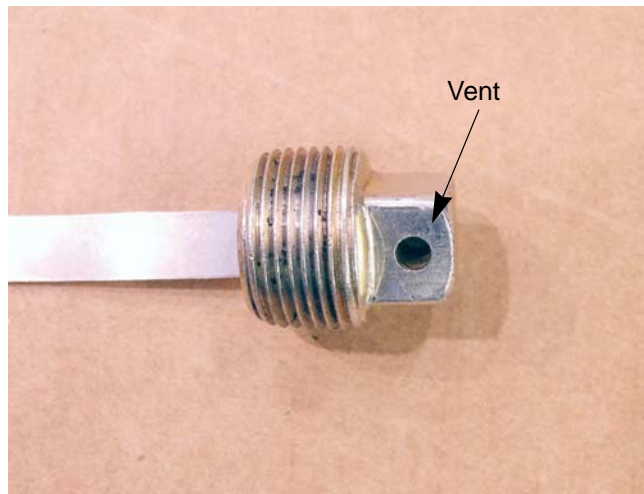

Figure 3.13



If the tank is pressurized by a blocked vent, relieve the pressure by extending the ram before attempting to remove the plug. Removing the plug from a pressurized tank can launch a dangerous projectile.

To check the tank vent:

- Remove the dip stick.
- Insert a piece of wire into the vent hole until it comes out of the rivet that attaches the dip stick to the plug. See Figure 3.14.

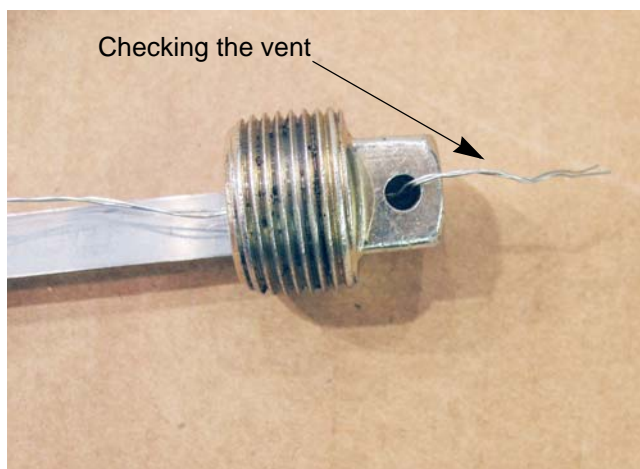

Figure 3.14

G. Replace the hydraulic oil filter:

- Turn the oil filter counter-clockwise to remove it.
- Coat the O-ring of the new oil filter with a light coat of oil.
- Thread the oil filter onto the oil filter housing hand tight

## Hydraulic Diagnosis

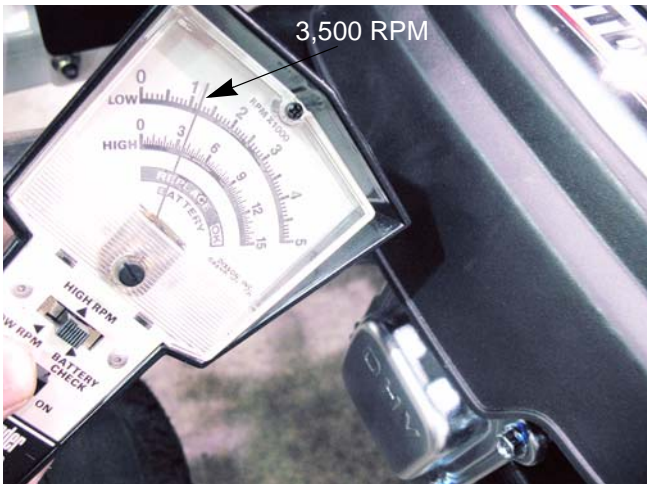

Figure 3.15

- H. Engine performance: See Figure 3.15.
- The engine should be adjusted to run at 3,500 RPM  $\pm$  100. Check it with a tachometer.
  - The engine must be in good state of tune: good spark plug, clean air filter, fresh fuel, clean carburetor, correct valve lash.
  - The engine must be in good mechanical condition: good compression.
  - If the engine speed is set correctly, but it slows-down excessively under load, there is an engine performance issue.
  - The engine performance issue must be fixed before valid pump tests can be made.

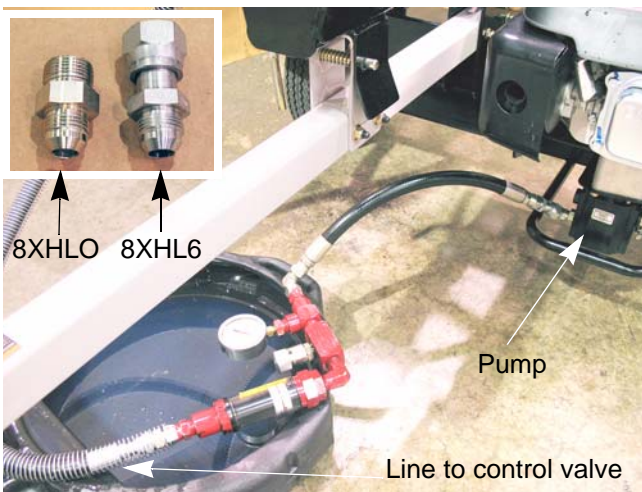

Figure 3.16

- I. With the engine turned-off, relieve hydraulic pressure from the system by moving the lever on the control valve through its full range of travel.
- J. Connect the flow and pressure test gauge set (P/N 759-3742) between the pump and the control valve.
- The pressure gauge should be on the pump side.
  - The flow meter should be on the control valve side.
- NOTE:** A 1/2" male JIC to 1/2" male O-ring face (OFS) adapter (Parker Hannifin number 8XHLO) and a 1/2" male JIC to a 1/2" female OFS (Parker Hannifin number 8XHL6) will be needed to connect the test kit to the log splitter. See Figure 3.16. Inset.
- K. Confirm that the needle valve on the test gauge set is fully open and all connections are tight.

**NOTE:** DO NOT use teflon tape on any fitting on a MTD log splitter. Pieces of the tape can get into the system and damage the valve or the pump.

**NOTE:** When tightening hoses with O-ring face fittings, hold the hose so that the center part of it does not rotate against the O-ring while the swivel section is tightened. If the center part rotates, the O-ring can be damaged and it will leak under pressure.

- L. Start and run the log splitter to warm-up the fluid and check the test set connections for leaks. Cycle the ram 12 times to purge air from the hydraulic system.



Hydraulic fluid under high pressure can be dangerous. A high-pressure hydraulic fluid leak or spray can penetrate the skin. If this happens, seek immediate medical attention to reduce the risk of blood poisoning leading to death or limb amputation.

If a hydraulic fluid leak develops at any time during testing or operation of the log splitter, turn it off and repair the leak before any further work is done.

Exhaust fumes from running engines contain carbon monoxide (CO). Carbon monoxide is a colorless odorless gas that is fatal if inhaled in sufficient quantity. Only run engines in well ventilated areas. If running engines indoors, use an exhaust evacuation system with adequate make-up air ventilated into the shop.

## 2010 Log Splitters

2. Pump base-line test (ram stationary)
  - A. Perform all of the procedures described in the preparation section of this chapter.
  - B. With the engine running, record the engine RPMs on the worksheet at the end of this chapter.

**NOTE:** Copies of the worksheet can be downloaded from the dealer service site or photo copied out of this book.

- C. Record the flow meter reading on the worksheet. See Figure 3.17.
- D. Record the pressure reading on the worksheet.

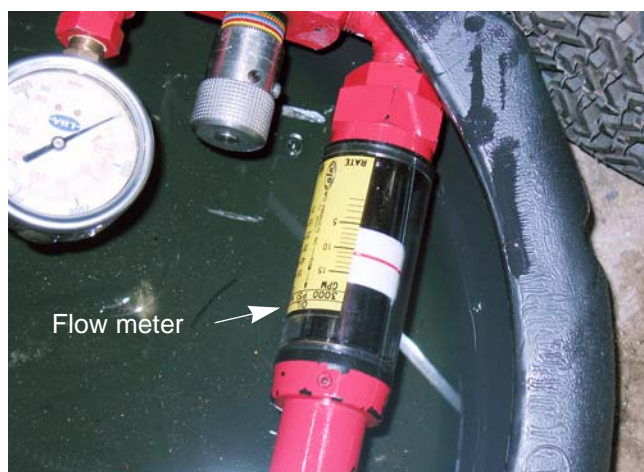

Figure 3.17

- E. Record the rated pump capacity from the pump capacities chart on to the worksheet.

Pump Capacities		
Pump	Tonnage	GPM/LPM ± 1 GPM
718-04127	21,25 and 27	9.5 (36 lpm)
718-04729	27 ton HP pump	13 (46 lpm)
718-04128	33	15 (57 lpm)

3. Pump load testing (ram stationary)
  - A. Slowly close the needle valve just far enough to identify the by-pass point.

**NOTE:** The by-pass point is the point where the pump switches from volume mode to pressure mode. There will be a noticeable drop in the flow reading.

- B. Record the engine RPMs on the worksheet.
- C. Record the flow meter reading on the worksheet.
- D. Record the pressure reading on the worksheet. See Figure 3.18.
- E. Record the rated pump by-pass setting from the pump by-pass settings chart on to the worksheet.



Figure 3.18



**Hydraulic Diagnosis**

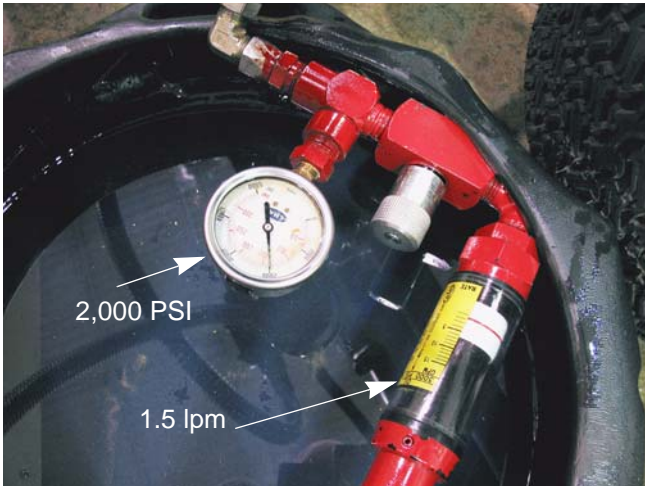

**Figure 3.19**

F. Slowly close the needle valve to build 2,000 PSI (220 Bars). See Figure 3.19.

<b>⚠ WARNING</b>	Do NOT exceed 3,200 PSI (220 Bars). This test is performed upstream of the relief valve in the log splitter hydraulic system, rendering the relief valve ineffective during the test. Over-loading the system will damage the pump.
------------------	---

- G. Record the engine RPMs on the worksheet.
- H. Record the flow meter reading on the worksheet.
- I. Record the pressure reading on the worksheet.
- J. IMMEDIATELY open the needle valve, then turn-off the engine.

Pump By-pass Settings			Pressure Mode Flow Capacities		
Pump	Tonnage	By-pass Pressure ± 100 PSI	Pump	Tonnage	GPM/LPM ± 0.5 gpm
718-04127	21,25 and 27	500 (34 bar)	718-04127	21,25 and 27	1.5 (5.5 lpm)
718-04729	27 ton HP pump	1,000 (69 bar)	718-04729	27 ton HP pump	3 (11 lpm)
718-04128	33	700 (48 bar)	718-04128	33	3 (11 lpm)

K. Record the rated flow rate from the pressure mode flow capacities chart on to the worksheet.

Interpreting the test results:

**NOTE:** The engine governor should hold engine RPMs constant during the test.

- If the pump fails to produce the base-line flow rate, but engine RPM is 3,500, there is problem with the drive system (engine coupler) or the pump.
- The flow should be within 1 GPM (3.8 LPM) of the rated capacity.
- If flow droops more than 1 GPM (3.8 LPM), and the engine RPM falls, there is an engine problem
- If pressure fails to build, there is a problem with the drive system (engine coupler, keys or the pump).
- If flow drops more than 1 GPM (3.8 LPM), the engine RPM does not change, and the engine exhaust note does not change, there is a problem with the drive system (engine coupler and spider) or the pump.
- If base-line flow is within 1 GPM (3.8 LPM), pressure builds to 2,000 PSI (138 Bars) when the needle valve is closed; the pump, engine, and drive are working properly.
- To identify drive problems examine the engine coupler and spider.
- If the pump fails to switch from volume mode to pressure mode within 100 PSI of the rate by-pass setting, the pump is bad.

## 2010 Log Splitters

4. Control valve test
  - A. Turn off the engine.
  - B. Relieve hydraulic pressure from the system by moving the lever on the control valve through its full range of travel.
  - C. Remove the test gauges from between the pump and the control valve.
  - D. Reinstall the original hydraulic hose that connected the pump to the control valve.
  - E. Install the test gauges between the log splitter control valve and the extend port on the hydraulic cylinder. See Figure 3.20.

- e1. Disconnect the hydraulic hose that runs from the log splitter control valve to the extend port on the hydraulic cylinder.

**NOTE:** The control valve is mounted to one of the trunnions of the cylinder. This makes it difficult to connect the test gauge set to the side of the hydraulic system that retracts the ram.

- e2. Install the test gauge set with the pressure gauge nearest on the control valve side and the flow meter on the cylinder side.

- e3. Start the engine.

- e4. Check for leaks.

- e5. Cycle the ram 12 times to warm-up the fluid and purge air from the hydraulic system.

- F. While extending the ram, gently release the control lever several times.

**NOTE:** The control lever must return to the neutral position as soon as it is released. If it fails to do so, even once, the valve must be replaced.

- G. Move the control lever to the retract position.

**NOTE:** The control lever should stay in the retract position until the ram is fully retracted. After the ram is retracted, the system will build pressure and return the control lever to the neutral position.

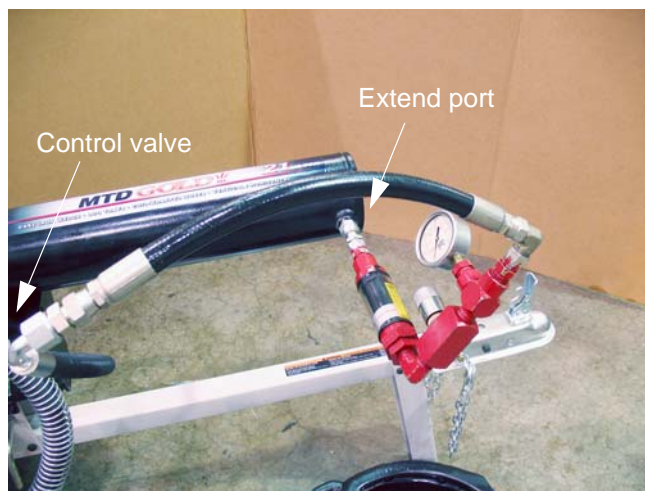

**Figure 3.20**

Relief Valve Settings		
Valve part number	Tonnage	Relief valve setting ± 100 PSI
718-04706	27 and 33	3400 PSI (234 bar)
718-04739	21	2700 PSI (186 bar)
718-04740	25	3200 PSI (221 bar)

H. Extend the cylinder fully using the log splitter control valve.

- As the ram reaches the end of its travel, pressure will build until the relief valve opens.
- Record the maximum pressure reached on the worksheet.

**NOTE:** If the needle on the pressure gauge moved too fast to get a good reading on the extension stroke, adjust the needle valve while retracting the cylinder to slow down the rate that the pressure builds. Repeat step H.

I. Record the rated relief valve pressure from the relief valve settings chart on to the worksheet.

**NOTE:** The relief valve is not adjustable. If the reading is more than 100 PSI of what is listed in the chart, replace the valve. If the reading is more than 100 PSI lower than what is listed in the chart, it could be a bad valve or a cylinder leaking internally.

5. Cylinder blow-by test:

- Hold the control valve in the extend position until the ram stops moving.
- Record the flow reading after the ram stops moving.

**NOTE:** Pressure decay when the ram is fully extended indicates that the cylinder/piston seals are not working.

**NOTE:** Seal kits are available to repair leaking cylinders. If the cylinder has mechanical damage, it must be replaced.

### What to do about failures

1. If a pump is bad:

- Replace the pump. The pump is not serviceable.
- If the pump failed because of an external cause, identify and eliminate the cause.

**NOTE:** Any disassembly of the pump WILL VOID THE WARRANTY. Do not take the pump apart if the repair is warrantable.

2. If the control valve is bad:

- If the repair is warrantable, replace the control valve.

**NOTE:** Any disassembly of the control valve WILL VOID THE WARRANTY. Do not take the control valve apart if the repair is warrantable.

3. If the cylinder is bad:

- If the cylinder is leaking at a seal, it may be repaired using a cylinder rebuild kit.
- If the cylinder is leaking at a welded seam, or has mechanical damage such as a bent shaft, replace the cylinder.

## 2010 Log Splitters

### System drawings

#### Control valve in Neutral

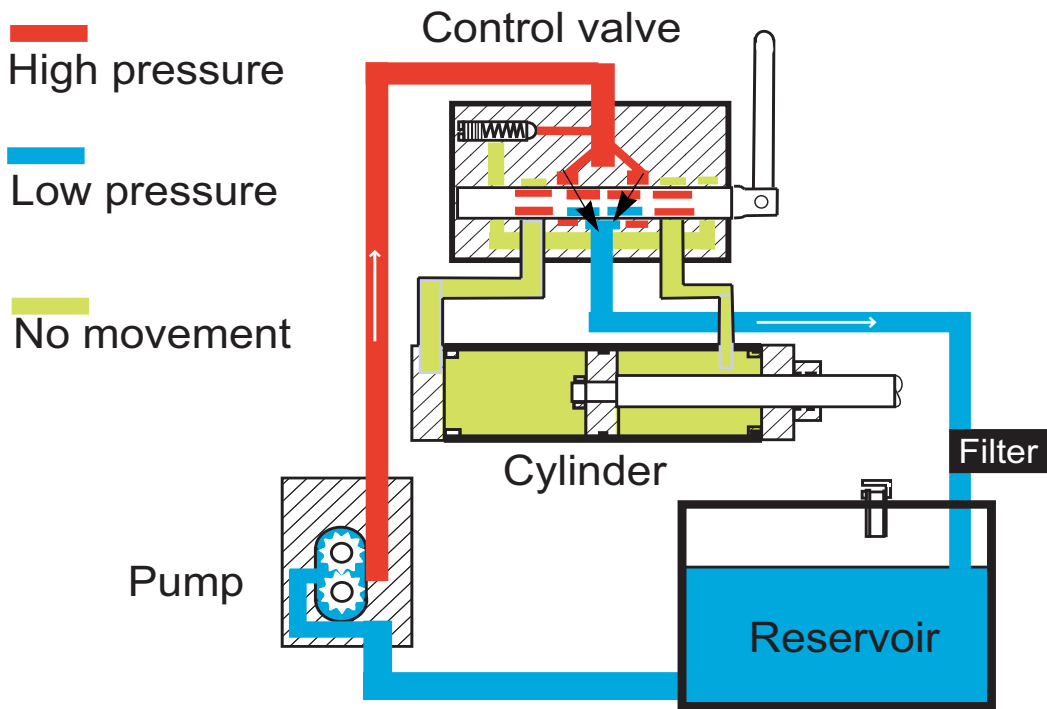

Figure 3.21

- The pump drives hydraulic fluid to the control valve.
- Fluid is shunted directly back to the reservoir
- No cylinder movement results

Control valve in Extend (splitting)

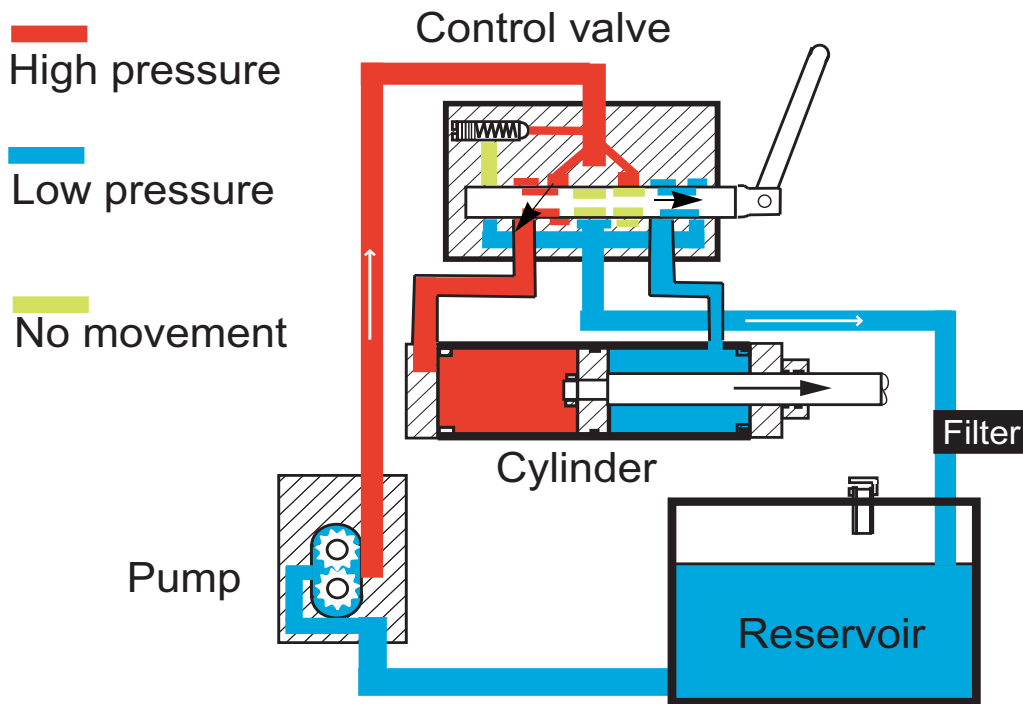

Figure 3.22

- The pump drives hydraulic fluid to the control valve.
- The spool in the control valve directs pressurized fluid to the base end of the cylinder.
- The pressurized fluid forces the piston up the bore of the cylinder.
- As the piston moves up the bore, it displaces fluid that is on the ram side of the piston.
- The spool in the control valve also connects ports joining the ram end of the cylinder to the reservoir.
- This allows displaced fluid to return to the reservoir.

## 2010 Log Splitters

### Control valve in Retract

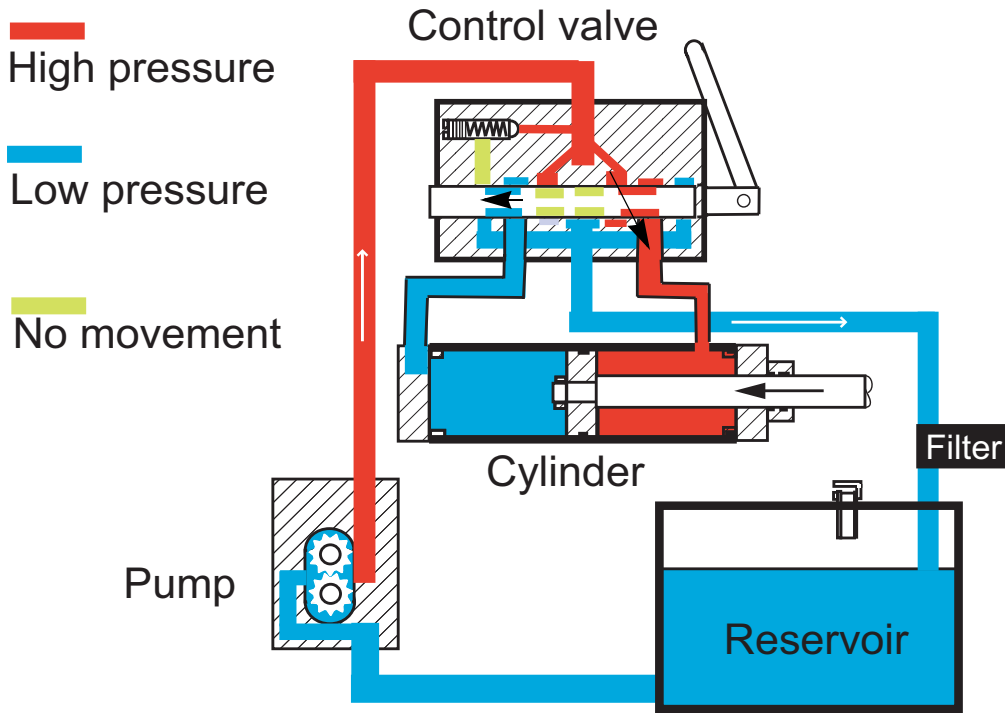

Figure 3.23

- The pump drives hydraulic fluid to the control valve.
- The spool in the control valve directs pressurized fluid to the ram end of the cylinder.
- The pressurized fluid forces the piston down the bore of the cylinder.
- As the piston moves down the bore, it displaces fluid that is on the base side of the piston.
- The spool in the control valve also connects ports joining the base end of the cylinder to the reservoir.
- This allows displaced fluid to return to the reservoir.

Relief in Neutral

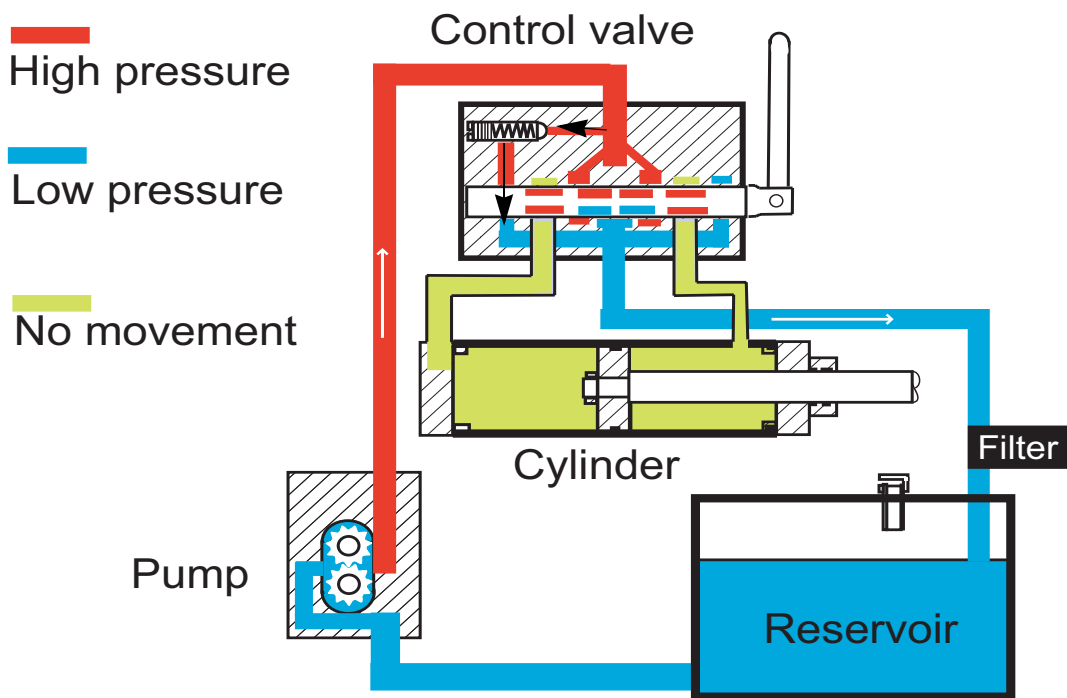

Figure 3.24

- This drawing shows the relief valve in action with the control valve in neutral.
- The relief action is the same no matter what position the control valve is in.
- If pressure builds beyond the pre-set limit, the relief valve opens, spilling fluid through a port that returns it to the reservoir.

For Parts Call 606-678-9623 or 606-561-4983

**2010 Log Splitters**



## LOG SPLITTER HYDRAULIC SYSTEM WORK SHEET

For use with test kit part number 759-3742

**NOTE:** This worksheet must be completed and submitted with the failed component for a warranty claim to be paid

Model number \_\_\_\_\_

**NOTE:** Detailed hydraulic system testing instructions can be found in the 2010 and Newer Log Splitters manual, form number 769-06184.

Serial number \_\_\_\_\_

Pump number \_\_\_\_\_

Valve number \_\_\_\_\_

1. Preparation

\_\_\_ Inspect the engine coupler, keys and the spider

\_\_\_ Check fluid flow from tank to pump (inlet screen)

\_\_\_ Check the hydraulic fluid level

\_\_\_ Inspect the tank vent

\_\_\_ Replace the oil filter

Check engine speed \_\_\_\_\_ RPM (set to 3,500)

\_\_\_ Install the test gauges between the pump and the selector valve.

\_\_\_ Start and run the log splitter to warm-up the fluid and check the test set connections for leaks. Cycle the ram 12 times to purge air from the hydraulic system.

Pump Capacities		
Pump	Tonnage	GPM/LPM ± 0.5 GPM
718-04127	21,25 and 27	9.5 (36 lpm)
718-04729	27 ton HP pump	13 (46 lpm)
718-04128	33	15 (57 lpm)

**NOTE:** The engine must be at 3,500 RPM for all testing. If the engine RPMs fall under load, repair the engine before testing the hydraulics.

2. Pump base-line test (ram stationary), record the following:

\_\_\_\_\_ Engine RPM

\_\_\_\_\_ Flow meter reading

\_\_\_\_\_ Pressure reading

\_\_\_\_\_ Flow rating from the pump capacities chart.

⚠ WARNING

Do NOT exceed 3,200 PSI (220 Bars). This test is performed up-stream of the relief valve, rendering the relief valve ineffective during the test. Overloading the system will damage the pump.

3. Pump load test (ram stationary), record the following:

3a. Slowly close the needle valve just far enough to identify the by-pass point.

\_\_\_\_\_ Engine RPM

\_\_\_\_\_ Flow meter reading

\_\_\_\_\_ Pressure reading

\_\_\_\_\_ Pressure rating from the by-pass settings chart.

Pump By-pass Settings		
Pump	Tonnage	By-pass Pressure ± 100 PSI
718-04127	21,25 and 27	500 (34 bar)
718-04729	27 ton HP pump	1,000 (69 bar)
718-04128	33	700 (48 bar)

3b. Continue closing the needle valve until the pressure gauge reads 2,000 PSI. Record the following:

- \_\_\_\_\_ Engine RPM
- \_\_\_\_\_ Flow meter reading
- \_\_\_\_\_ Pressure reading
- \_\_\_\_\_ Flow from the pressure mode flow capacities chart.

- Open the needle valve to relieve the pressure and turn off the engine

Interpreting the results:

- A significant difference between the specified and observed pump performance indicates a bad pump.

4. Control valve test

- \_\_\_\_\_ Relieve the hydraulic pressure from the system.
- \_\_\_\_\_ Install the test gauges between the control valve and the cylinder.
- \_\_\_\_\_ Warm-up the fluid and purge air from the hydraulic system.
- \_\_\_\_\_ Control returns to the stop position when released from the extend position.
- \_\_\_\_\_ Control stays in the retract position until the piston is fully retracted.

- 4a. Extend the cylinder fully using the log splitter control valve.
- As the ram reaches the end of its travel, pressure will build until the relief valve opens. Record the following:

- \_\_\_\_\_ Maximum pressure reached.
- \_\_\_\_\_ Relief valve setting from the relief valve settings chart.

**NOTE:** The relief valve is not adjustable. If the reading does not match what is listed in the chart, replace the valve. A high reading is a bad control valve. A low reading could be a bad valve or a cylinder leaking internally.

5. Cylinder blow-by test

- 5a. Hold the control valve until the ram stops moving.

- \_\_\_\_\_ Record the flow reading.

**NOTE:** Fluid movement when the ram is fully extended indicates that the piston seals are not working.

**NOTE:** Seal kits are available to repair leaking cylinders. If the cylinder has mechanical damage it must be replaced.

Pressure Mode Flow Capacities		
Pump	Tonnage	GPM/LPM ± 0.5 GPM
718-04127	21,25 and 27	1.5 (5.6 lpm)
718-04729	27 ton HP pump	3 (11 lpm)
718-04128	33	3 (11 lpm)

**NOTE:** If the readings are low, inspect the engine coupler, the keys, set screws and the spider before condemning the pump.

Relief Valve Settings		
Valve part number	Tonnage	Relief valve setting ±100 PSI
718-04706	27 and 33	3400 PSI (234 bar)
718-04739	21	2700 PSI (186 bar)
718-04740	25	3200 PSI (221 bar)

## CHAPTER 4: CONTROL VALVE

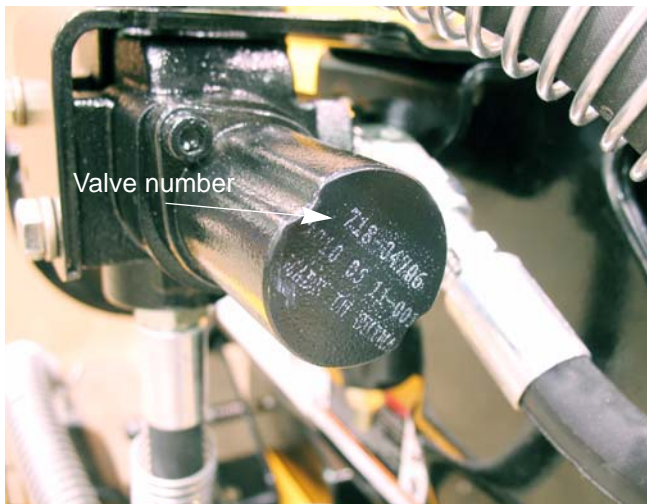

Figure 4.1

MTD uses three different control valves on log splitters. The size of the log splitter determines which valve is used.

The three different valves are identical on the outside. Whenever testing or replacing a control valve, verify the part number of the valve on the splitter is the one listed in the parts drawing for that specific splitter. The valve part number is stamped into the end cap of the valve. See Figure 4.1.

**NOTE:** The numbers were filled with white paint to improve visibility for the picture.

**NOTE:** The only parts of the control valve that are serviceable are the spring cover, lever, master link and the lever bracket.

**NOTE:** DO NOT use teflon tape on any fitting on a MTD log splitter. Pieces of the tape can get into the system and damage the valve or the pump.

### Control valve removal/replacement

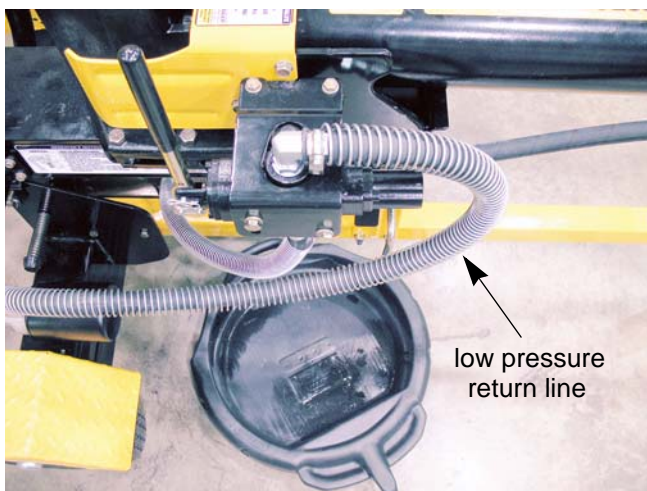

Figure 4.2

To remove a control valve:

1. With the engine turned-off, relieve hydraulic pressure from the system by moving the lever on the control valve through its full range of travel.



Hydraulic fluid under high pressure can be dangerous. A high-pressure hydraulic fluid leak or spray can penetrate the skin. If this happens, seek immediate medical attention to reduce the risk of blood poisoning leading to death or limb amputation.

2. Thoroughly clean all dirt and debris from around the valve.

**NOTE:** Any dirt or debris that gets inside the valve can destroy it.

3. Place a suitable container under the valve to catch the fluid that will leak out as the hydraulic lines are removed. See Figure 4.2.

4. Loosen the hose clamp on the low pressure return line using a 5/16" wrench.
5. Disconnect the low pressure return line.

## 2010 Log Splitters

6. Disconnect the high pressure hose from the pump.
7. Disconnect the high pressure supply hose from the valve using a 15/16" wrench. See Figure 4.3.
8. Disconnect the high pressure hose that connects the valve to the base of the cylinder.

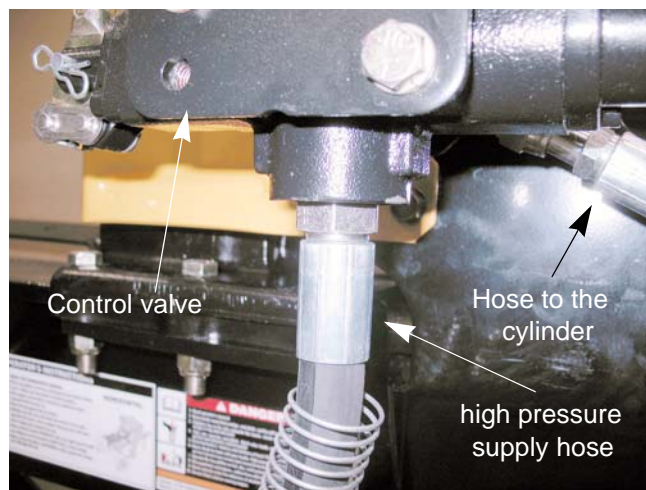

Figure 4.3

9. Remove the return hose fitting:
  - 9a. Hold the fitting with a 1" wrench. See Figure 4.4.
  - 9b. Back off the jam nut with a 1" wrench.
  - 9c. Remove the fitting.

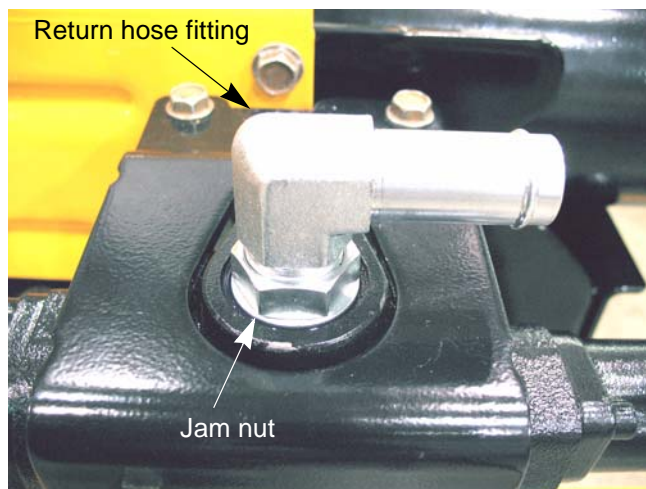

Figure 4.4

10. Remove the two screws that hold the valve to the mounting bracket using a 9/16" wrench. See Figure 4.5.
11. Remove the two screws that hold the mounting bracket to the cylinder using a 1/2" wrench. See Figure 4.5.

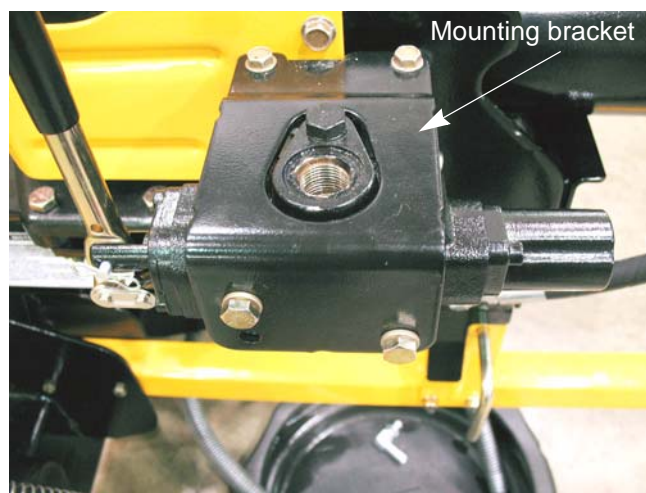

Figure 4.5

## Control valve



Figure 4.6

12. Hold the straight fitting with a 1" wrench. See Figure 4.6.
13. Back off the jam nut using a 7/8" wrench. See Figure 4.6.
14. Unthread the straight fitting and valve from the cylinder.

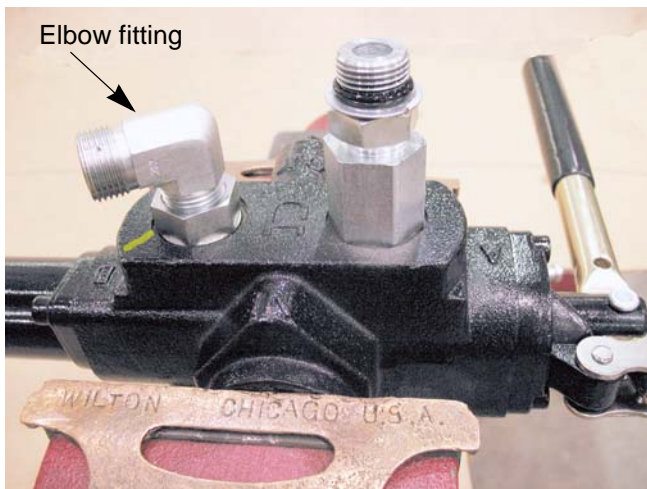

Figure 4.7

15. Place the control valve in a vise with the straight fitting facing up. See Figure 4.7.
16. Remove the straight fitting.
17. Mark the orientation of the elbow to the valve.
18. Loosen the jam nut on the elbow fitting using a 15/16" wrench.

## 2010 Log Splitters

To install the valve:

19. Transfer the elbows orientation mark to the new valve.
20. Check or replace the O-rings on the fittings.
21. Thread the elbow into the valve, hand tight, until it is aligned with the orientation mark.
22. Tighten the jam nut until the O-ring is compressed.
23. Thread the end of the straight fitting without the jam nut into the control valve. Tighten the fitting until it compresses the O-ring.
24. Thread the straight fitting and control valve into the cylinder hand tight.

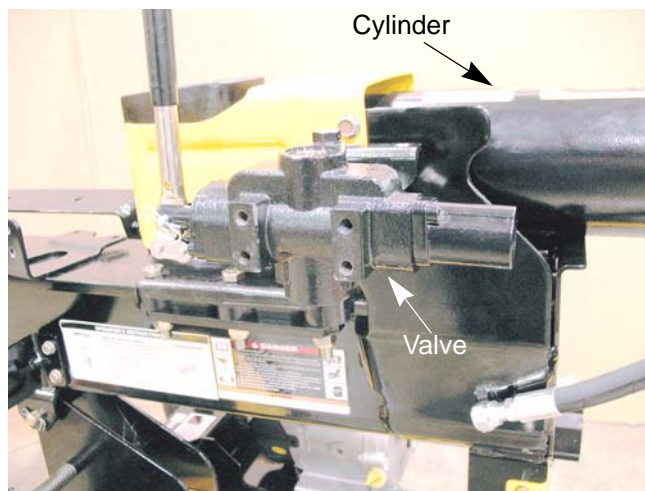

**Figure 4.8**

25. Align the valve so that it is parallel to the cylinder. See Figure 4.8.

26. Finish installing the control valve by following steps 1 - 12 in reverse order.

**NOTE:** The threads of the straight fitting are sealed by the jam nut compressing the O-ring, not by bottoming out the threads.

**NOTE:** When tightening hoses with O-ring face fittings, hold the hose so that the center part of it does not rotate against the O-ring while the swivel section is tightened. If the center part rotates, the O-ring can be damaged and it will leak under pressure.

27. Replace the filter by following the procedures described in Chapter 8: Maintenance.
28. Check the hydraulic fluid level.
29. Start the engine.
30. Cycle the control valve through its full range of travel 12 times to bleed the air from the system.
31. Test run the splitter before returning it to service.

### Control valve spring cover

## Control valve



Figure 4.9



Figure 4.10

To replace the valve spring cover:

**NOTE:** The spring cover part number is 718-0522.

1. Thoroughly clean the valve and surrounding area.

**NOTE:** Any dirt or debris that gets inside the valve can destroy it.

2. Remove both of the socket headed cap screws that hold the spring cover to the valve using a 5 mm hex key. See Figure 4.9.

3. Remove the spring cover.

4. Carefully remove the old sealant from the valve.

**NOTE:** Not all of the valves will have sealant under the spring cover.

5. Thoroughly clean the exposed area of the valve.

To install the spring cover:

6. Apply a small bead of Loctite® 515 Flange Sealant or equivalent compound to the spring cover.

7. Apply a small amount of releasable thread locking compound such as Loctite® 242 (blue) to the threads of the socket headed cap screws.

8. Install the spring cover and tighten the screws to a torque of 70 - 90 in lbs (8 - 10 Nm).

9. Test run the splitter in a safe area before returning it to service.

## 2010 Log Splitters

### Control valve lever bracket

To replace the lever bracket:

**NOTE:** The lever bracket part number is 718-04765.

1. Thoroughly clean the valve and surrounding area.

**NOTE:** Any dirt or debris that gets inside the valve can destroy it.

2. Remove the bowtie clip and the clevis pin. See Figure 4.11.
3. Slide the control lever out of the end of the spool and let it hang down.

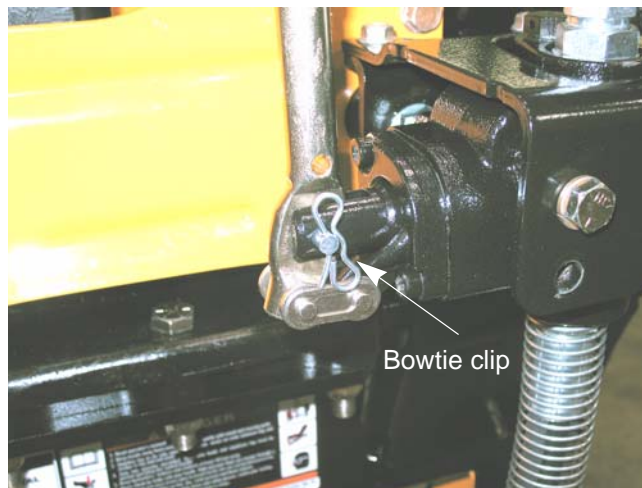

Figure 4.11

4. Remove the master link locking clip. See Figure 4.12.
5. Remove the master link top plate.
6. Remove the master link and the control lever.

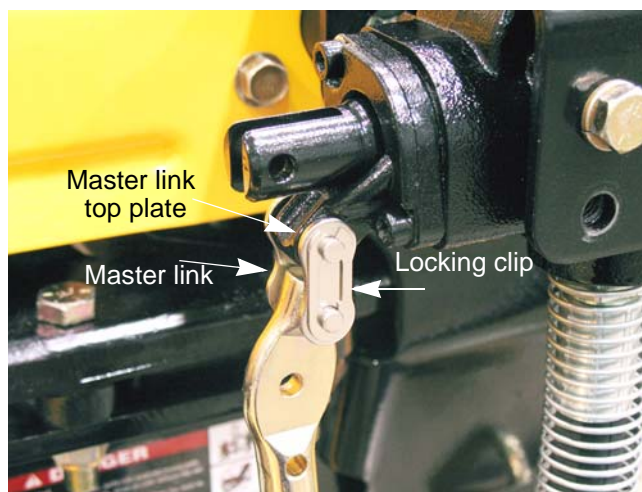

Figure 4.12

7. Remove both of the socket head cap screws that hold the lever bracket to the valve using a 5 mm hex key. See Figure 4.13.
8. Remove the lever bracket.
9. Install the lever bracket by following the previous steps in reverse order.

**NOTE:** Apply a small amount of releasable thread locking compound such as Loctite® 242 (blue) to the threads of the socket headed cap screws, and tighten the screws to a torque of 70 - 90 in lbs (8 - 10 Nm).

10. Test run the splitter in a safe area before returning it to service.



Figure 4.13



## CHAPTER 5: CYLINDER

### Cylinder removal



Figure 5.1



Figure 5.2

To remove/replace the cylinder:

1. With the engine turned-off, relieve hydraulic pressure from the system by moving the lever on the control valve through it's full range of travel.



**DANGER** Hydraulic fluid under high pressure can be dangerous. A high-pressure hydraulic fluid leak or spray can penetrate the skin. If this happens, seek immediate medical attention to reduce the risk of blood poisoning leading to death or limb amputation.

2. Thoroughly clean all dirt and debris from around the valve.

**NOTE:** Any dirt or debris that gets inside the valve can destroy it.

3. Place a suitable container under the valve to catch any fluid that will leak out as the hydraulic lines are removed. See Figure 5.1.

4. Place a saw horse or something similar under the rear of the cylinder to support it. See Figure 5.2.

5. Remove the control valve by following the procedures described in Chapter 4: Control Valve.

**NOTE:** The high pressure hose should be removed from the base of the cylinder.

## 2010 Log Splitters

6. Remove the six screws that secure the log dislodger to the beam using a 9/16" wrench. See Figure 5.3.



Figure 5.3

7. Remove the nut and bolt that attach the wedge to the cylinder ram using a pair of 3/4" wrenches.
8. Remove the cylinder from the log splitter.
9. Install the cylinder by following the previous steps in reverse order.

**NOTE:** When tightening hoses with O-ring face fittings, hold the hose so that the center part of it does not rotate against the O-ring while the swivel section is tightened. If the center part rotates, the O-ring can be damaged and it will leak under pressure.

10. Fill the hydraulic reservoir.
11. Start the log splitter.
12. Cycle the ram 12 times to purge air from the hydraulic system.
13. Check hydraulic fluid level, fill as needed.
14. Test run the splitter in a safe area before returning it to service.

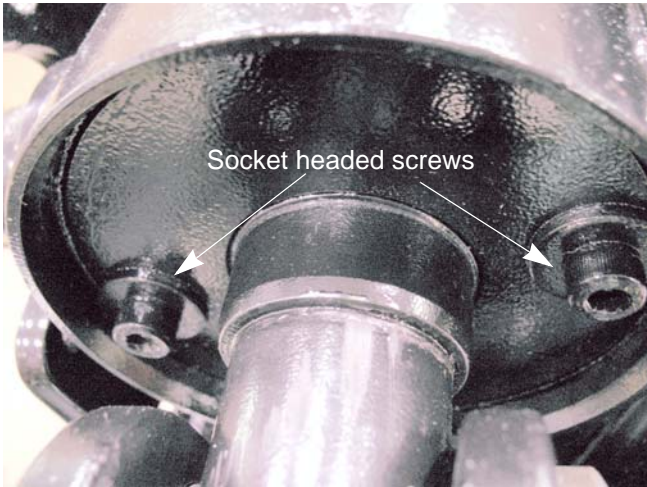

Figure 5.4

**Cylinder rebuilding**

The cylinder used on the MTD log splitter come from two different suppliers but have the same part number. When replacing the whole cylinder, the two are interchangeable. However, when rebuilding the cylinder, the manufacturer (type) of the cylinder must be identified so that the proper rebuild kit can be ordered. The cylinders are identified as E-type and X-type.

To identify the cylinder type:



**Figure 5.5**

The E-type cylinder:

- Uses socket headed screws with washers to hold the rod guide against the retaining ring.

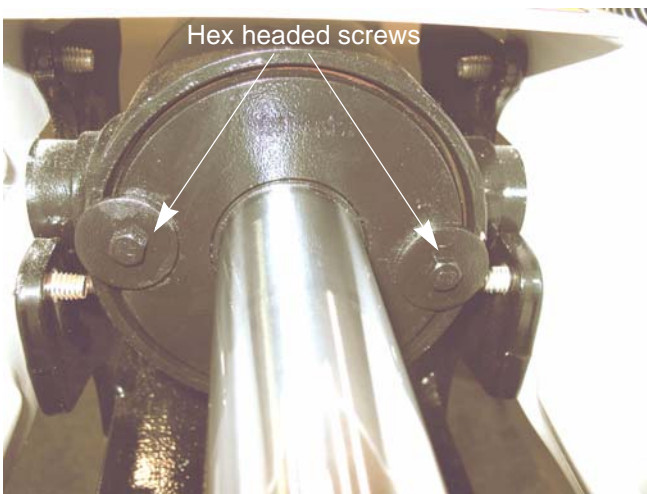

**Figure 5.6**

The X-type cylinder:

- Uses two hex headed screws with washers to hold the rod guide against the retaining ring.

## 2010 Log Splitters

To rebuild a cylinder:

The procedures to rebuild an "E-type" or an "X-type" cylinder are the same.



Hot hydraulic fluid can cause burns. Do not work on the cylinder until the hydraulic system has cooled to ambient temperature after use.



Hydraulic fluid under high pressure can be dangerous. A high-pressure hydraulic fluid leak or spray can penetrate the skin. If this happens, seek immediate medical attention to reduce the risk of blood poisoning leading to death or limb amputation.

If a piece of hydraulic equipment develops a high pressure leak, turn it off immediately. Do not operate it until the leak is repaired.

1. Clean the log splitter to prevent any dirt or debris from getting into the hydraulic system.
2. Block the wheels of the log splitter to prevent it from moving. See Figure 5.7.  
**NOTE:** If there are hydraulic leaks or the possibility further damage to the cylinder, skip step 3.
3. Start the engine and cycle the control valve until the ram is fully extended.
4. Turn off the engine and allow the engine and the hydraulic fluid to cool down.
5. Relieve hydraulic pressure from the system by moving the lever on the control valve through it's full range of travel.

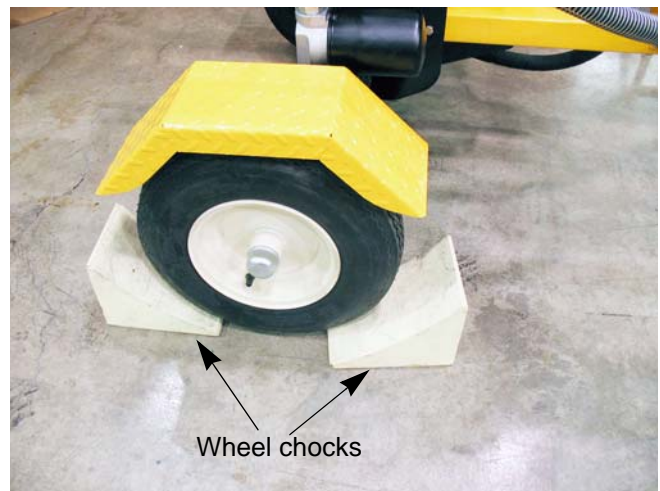

Figure 5.7

6. Place a suitable 5 gallon bucket under the valve to catch the hydraulic fluid from the cylinder and the lines. See Figure 5.8.
7. Disconnect the high pressure hose that goes to the base of the cylinder from the control valve.  
**NOTE:** Route the hose into the bucket.
8. Disconnect the return hose from the oil filter housing.  
**NOTE:** Route the hose into the bucket.

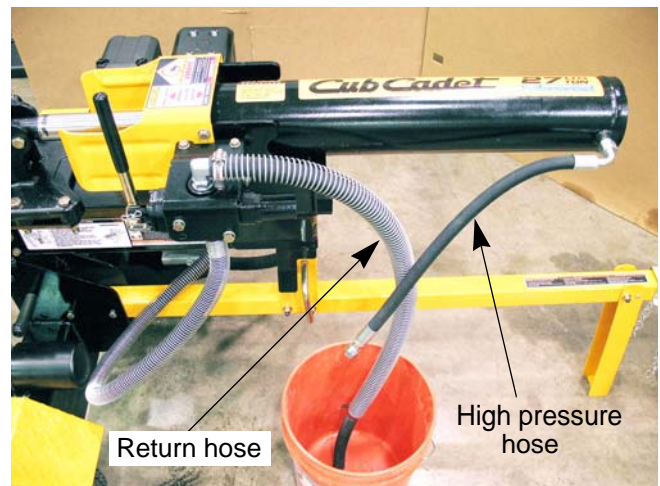

Figure 5.8

## CYLINDER

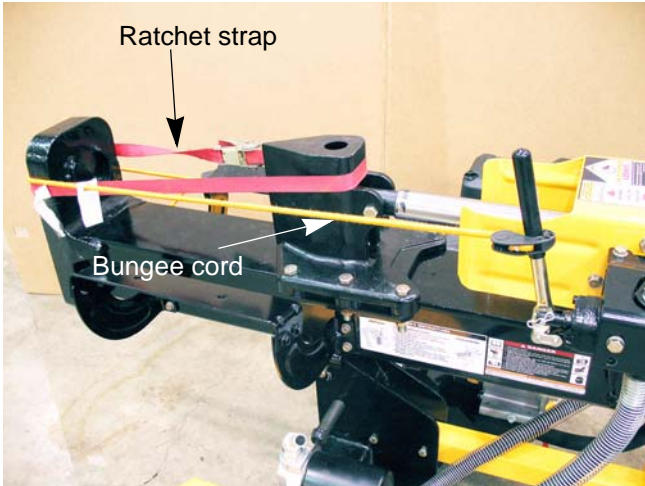

Figure 5.9

9. Wrap a ratchet strap around the wedge and the base plate. See Figure 5.9.
  10. Hold the control valve in the extend position.
- NOTE:** A bungee cord can be used to hold the control valve in the extend position. See Figure 5.9.
11. Tighten the ratchet strap until the ram is fully extended.



Figure 5.10

12. Move the control valve to the retract position.
  13. Wrap a heavy duty ratchet strap around the cylinder and wedge. See Figure 5.10.
  14. Tighten the ratchet strap until the ram is fully retracted.
- NOTE:** Hydraulic fluid will be draining from the return hose while the ram is retracting.
15. Remove the control valve by following the procedures described in Chapter 4: Control Valve.

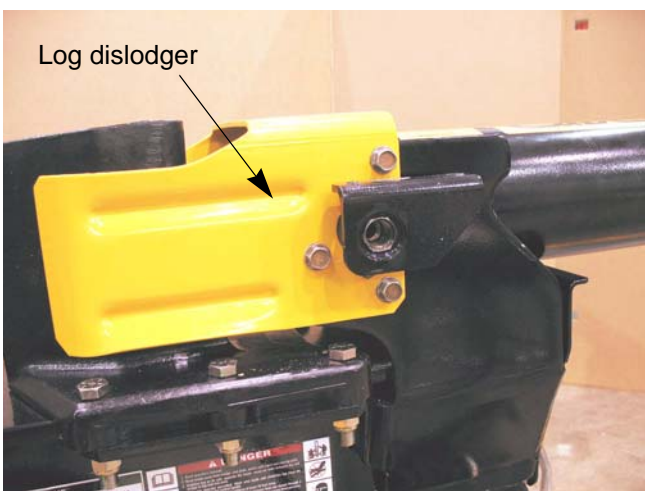

Figure 5.11

16. Remove the six screws that secure the log dislodger to the beam using a 9/16" wrench. See Figure 5.11.

## 2010 Log Splitters

17. Remove the nut and bolt that attached the wedge to the cylinder ram using a pair of 3/4" wrenches. See Figure 5.12.

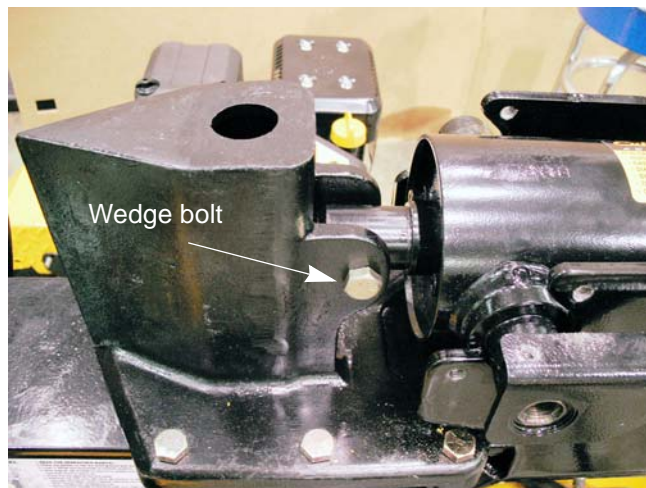

Figure 5.12

18. Place the cylinder in a vise with padded jaws.  
**NOTE:** DO NOT over tighten the vise. This can deform the cylinder preventing the piston and rod removal.
19. Remove the two screws and washers that hold the rod guide in place. See Figure 5.13.  
**NOTE:** There is thread locking compound on the screws. It may be necessary to apply some heat to the rod guide to release the screws.
20. Gently tap the rod guide into the cylinder using a brass punch until it clears the retaining ring.



Figure 5.13

21. Remove the retaining ring. See Figure 5.14.  
**NOTE:** Be careful not to scratch any part of the cylinder bore or the ram.  
**NOTE:** A brass pick can be made out of a brazing rod. It can be used to pry the retaining ring out of the cylinder without damaging the cylinder or the ram.  
**NOTE:** There will be some residual fluid in the cylinder. Place some rags or paper towels under the ram end of the cylinder to catch the fluid that spills.

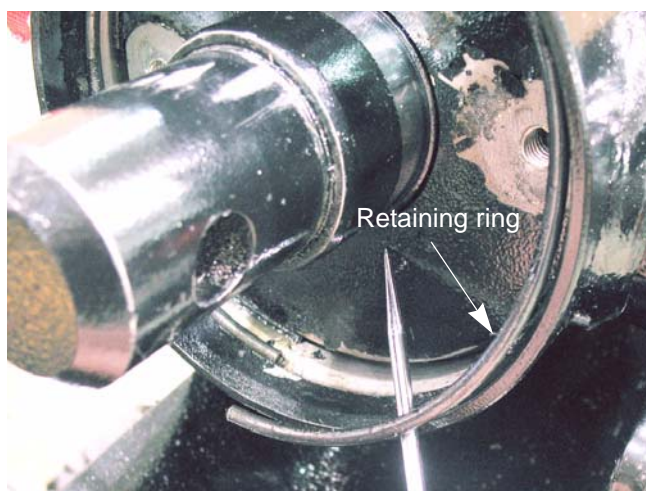

Figure 5.14

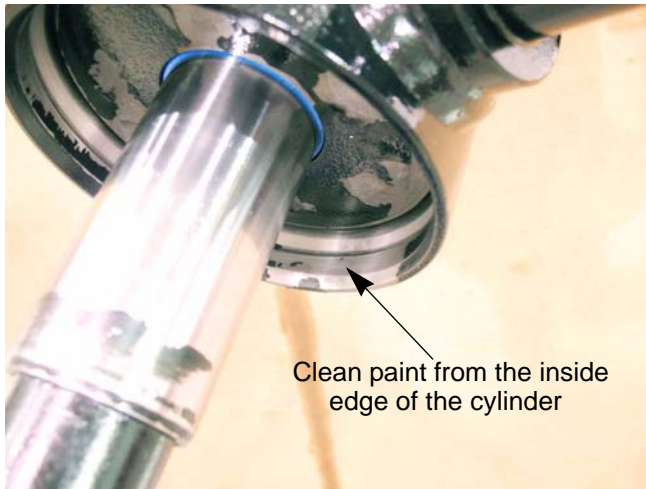

Figure 5.15

22. Clean the paint from the inside edge of the cylinder. See Figure 5.15.

**NOTE:** Paint on the inside edge of the cylinder can catch the back-up ring, pulling it out of the groove and wedging between the rod guide and the cylinder wall.

23. Pull the ram out of the cylinder.

<b>CAUTION</b>	Do not use compressed air to force the piston out of the log splitter bore. Compressed air may eject the piston with dangerous force.
----------------	---

**NOTE:** The piston will catch the rod guide and pull it out with the ram.

**NOTE:** The piston and the rod guide may separate from the cylinder quickly. Be prepared to support the weight of the rod and the guide.

**NOTE:** Be careful not to mar the chromed surface of the piston rod.

**NOTE:** If the rod guide will not come out of the cylinder:

- Push the ram all the way in.
- Attach a puller to the rod guide. See Figure 5.16.
- Gently pull the rod guide out.

**NOTE:** If a puller was needed to pull the rod guide out, the outer O-ring and the back-up ring of the rod guide are most likely destroyed.

24. Slide the rod guide to the end of the ram, opposite the piston.

25. Support the ram in a vise with padded jaws.

26. Remove the rod guide.

**NOTE:** If there is paint on the end of the rod, it must be removed before the rod guide can be removed.

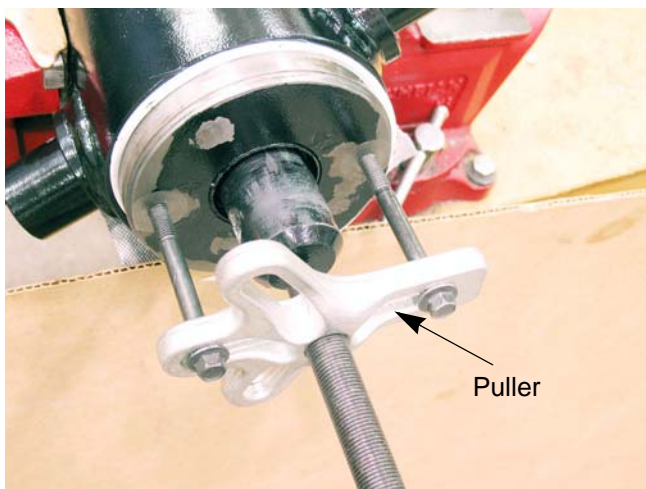

Figure 5.16

**NOTE:** DO NOT remove the piston from the ram. The O-ring between the ram and the piston is not serviceable.

27. Inspect the cylinder and rod before proceeding:

27a. Inspect the shaft and piston to confirm that the cylinder is rebuildable.

**NOTE:** A bend or surface damage on the rod will make the cylinder unfeasible to rebuild.

27b. Inspect the cylinder bore for deformations and surface damage.

27c. Inspect the hydraulic fittings on the cylinder for damage.

27d. Inspect the cylinder for cracks around the fittings and welds. Magnaflux if in doubt.

## 2010 Log Splitters

28. Carefully pry the outer piston seal off of the piston. See Figure 5.17.
29. Carefully pry the O-ring out of the groove in the piston.
30. Install a new O-ring and outer piston seal.

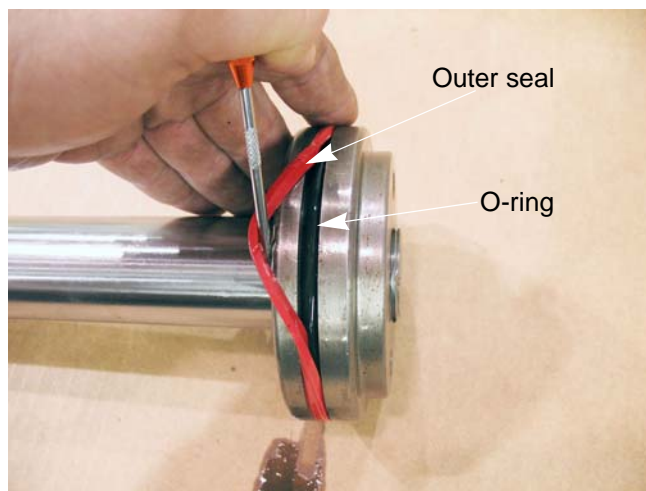

Figure 5.17

31. Carefully pry the back-up ring out of the groove in the outside diameter of the rod guide.
32. Carefully pry the O-ring seal out of the groove in the outside diameter of the rod guide. See Figure 5.18.

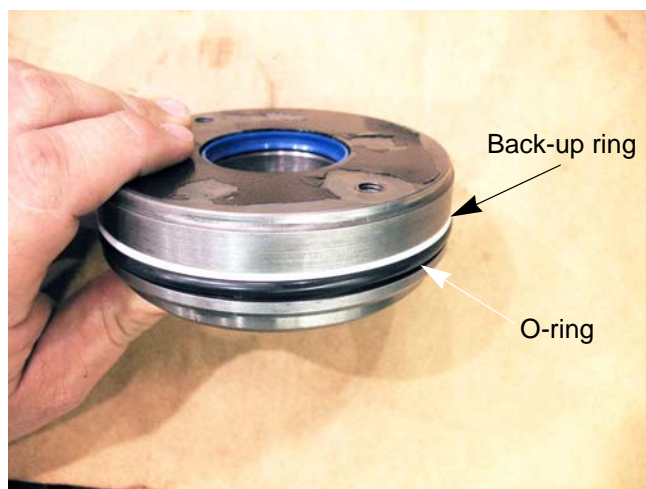

Figure 5.18

33. Carefully pry the scraper out of the recess in the rod guide. See Figure 5.19.
34. Carefully pry the internal seal out of its recess in the rod guide.
35. Compress the new seal and position it with the lip facing away from the side of the rod guide that has the screw holes, then let it expand into the groove that it will ride in.
36. Install the new scraper in the recess in the side of the rod guide that has the screw holes.

**NOTE:** Soaking the new scraper and seal in hot water will make them more pliable.

**NOTE:** The scraper has an "L" shaped cross-section. The leg of the L should face the screw hole side of the rod guide.



Figure 5.19



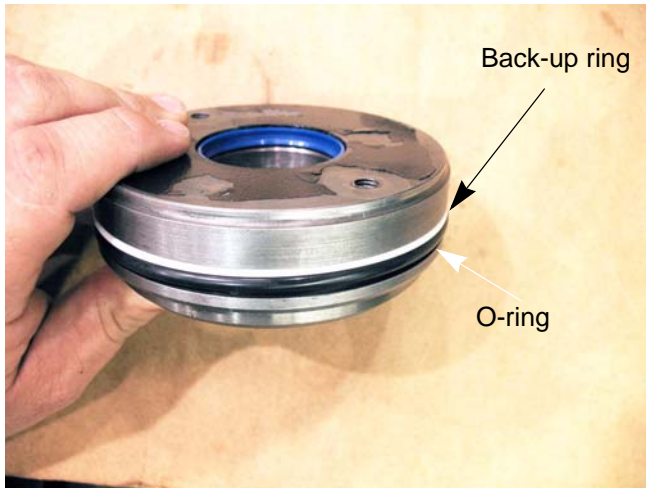

Figure 5.20

37. Install a new back-up ring in the groove, positioned at the edge of the groove that is closer to the side of the rod guide that has the screw holes.
38. Install a new O-ring seal in the groove, next to the back-up ring.

39. Lubricate the piston with the same type of fluid that will be used in the hydraulic system of the log splitter: 10W hydraulic fluid, or Dexron III automatic transmission fluid.
40. Insert the shaft and piston into the bore of the cylinder.
41. Lubricate the seals on the rod guide using the same type of fluid that will be used in the hydraulic system of the log splitter.
42. Insert a protector sleeve through the seal and scraper to prevent damage during installation.
43. Slip the rod guide over the shaft and into the bore of the cylinder.
44. Use a length of 2" iron pipe (or similar driver) to drive the rod guide into the bore, past the groove that the wire snap ring locks into.
45. Install the snap ring.

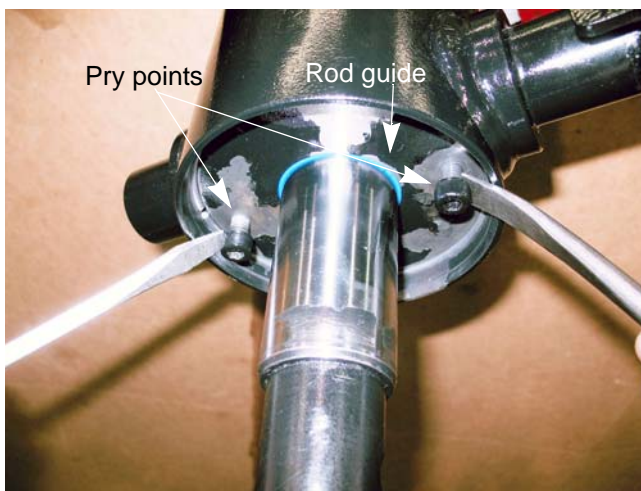

Figure 5.21

46. Pull the shaft and piston up to the top of the bore, so that the piston moves the rod guide back into place against the snap ring.
47. Pull the shaft and piston up to the top of the bore, so that the piston moves the rod guide back into place against the snap ring. See Figure 5.21.

**NOTE:** The bolts may be installed temporarily, for use as pry-points.

## 2010 Log Splitters

48. Tighten the screws and washers to lock the rod guide in place. See Figure 5.22.
49. Put the cylinder in its normal operating position.
50. Attach the wedge to the ram.
51. Attach the log dislodger.
52. Install the control valve.
53. Connect the hydraulic lines.

**NOTE:** When tightening hoses with O-ring face fittings, hold the hose so that the center part of it does not rotate against the O-ring while the swivel section is tightened. If the center part rotates, the O-ring can be damaged and it will leak under pressure.

54. Re-fill the hydraulic system.
55. Run, purge, and test the log splitter before returning it to service.

**NOTE:** Cycle the cylinder 12 times to purge air from the hydraulic system, then top-up the fluid.



**Figure 5.22**

## CHAPTER 6: WEDGE AND BEAM

### Wedge

Starting with 2010 production, MTD log splitters have a new beam design. The new beam is made from a heavy gauge U-channel with a flat plate welded to the top. This replaces the old extruded I-beam design. The new beam is machined to tighter tolerances than the old design, eliminating the need for an adjustable gib.

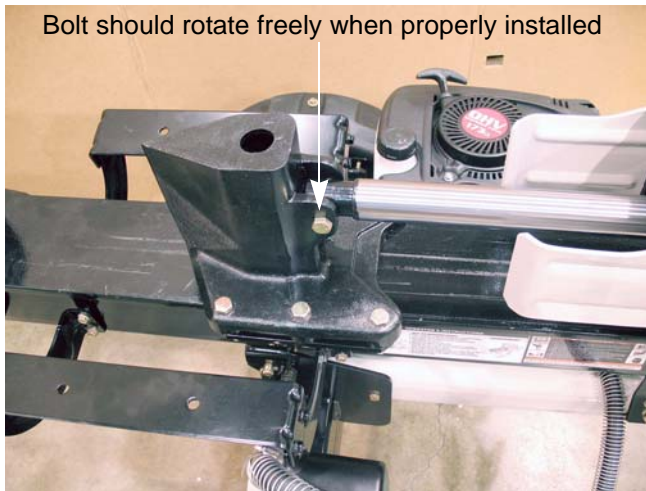

Figure 6.1

To replace a wedge:

1. Extend the wedge to the middle of the beam.
2. Remove the nut and bolt that attach the wedge to the ram using a pair of 3/4" wrenches. See Figure 6.1.
3. Slide the wedge toward the base of the beam until it clears the ram.

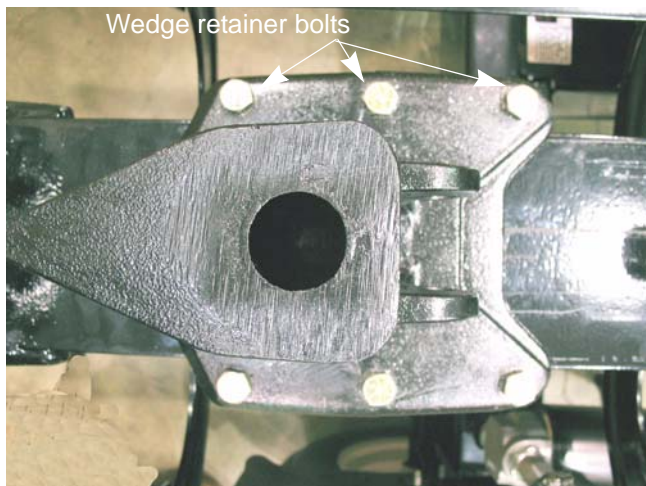

Figure 6.2

4. Remove the six nuts and bolts that attach the wedge retainer plates to the wedge using a pair of 3/4" wrenches. See Figure 6.2.
5. Remove the wedge.

To install the wedge:

1. Inspect the beam for any nicks or burrs along the edges.

**NOTE:** If any are found, dress them off of the beam.

2. Install the wedge and the wedge retainer plates. Tighten the six nuts and bolts to a torque of 38 - 53 ft lbs (52 - 72 Nm).

**NOTE:** The wedge should move freely up and down the beam.

3. Attach the wedge to the ram and tighten the nut and bolt until the threads of the bolt pass through the locking feature of the nut. When torqued, the bolt should rotate freely in the holes. **DO NOT** over torque the nut and bolt.

**NOTE:** The end of the ram presses against the wedge casting when splitting. The nut and bolt are only to hold the wedge to the ram while it is retracting.

4. Test run the splitter in a safe area before returning it to service.

## 2010 Log Splitters

### Beam

To remove/replace the beam:

1. With the engine turned-off, relieve hydraulic pressure from the system by moving the lever on the control valve through it's full range of travel.

**NOTE:** If the shop has equipment that can safely lift the cylinder without straining the hydraulic lines, this job can be done without disconnecting the hoses.



Hydraulic fluid under high pressure can be dangerous. A high-pressure hydraulic fluid leak or spray can penetrate the skin. If this happens, seek immediate medical attention to reduce the risk of blood poisoning, which can lead to death or limb amputation.

2. Thoroughly clean all dirt and debris from around the valve.

**NOTE:** Any dirt or debris that gets inside the valve can destroy it.

3. Place a suitable container under the valve to catch any fluid that will leak out as the hydraulic lines are removed. See Figure 6.3.
4. Loosen the hose clamp on the low pressure return line using a 5/16" wrench.
5. Disconnect the low pressure return line.

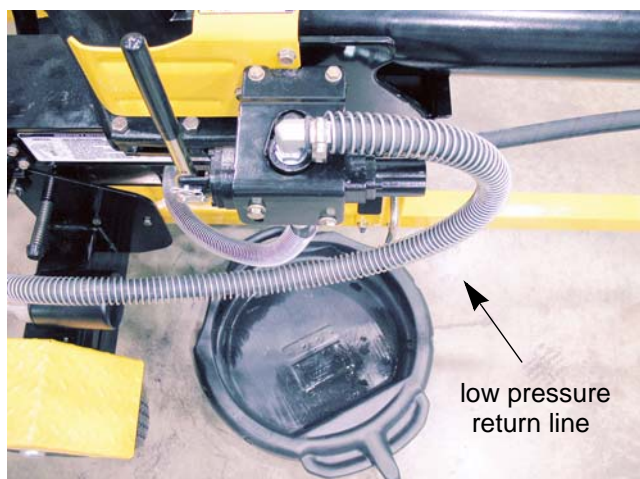

Figure 6.3

6. Disconnect the high pressure hose from the pump.
7. Disconnect the high pressure supply hose from the valve using a 15/16" wrench. See Figure 6.4.

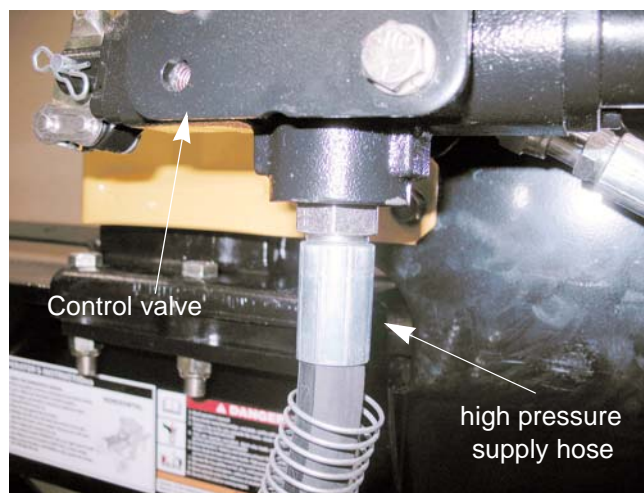

Figure 6.4

## Wedge and Beam



Figure 6.5

8. Remove the six screws that attach the log dislodger to the beam using a 9/16" wrench. See Figure 6.5.

**NOTE:** The 33 ton models only have four screws.

9. Remove the dislodger from the log splitter.

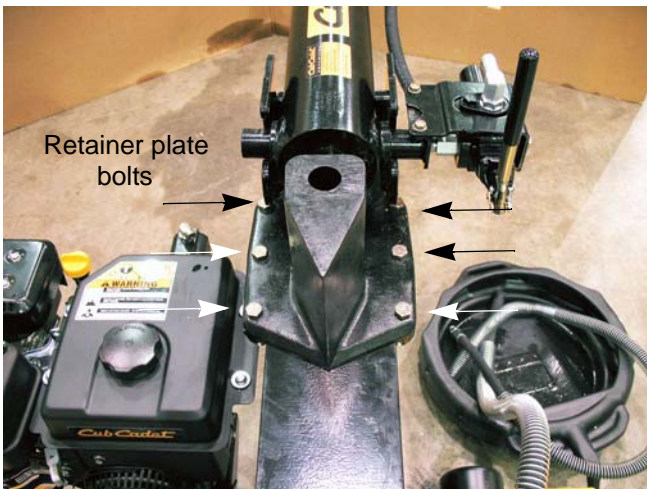

Figure 6.6

10. Remove the six nuts and bolts that attach the wedge retainers plates to the wedge using a pair of 3/4" wrenches. See Figure 6.6.

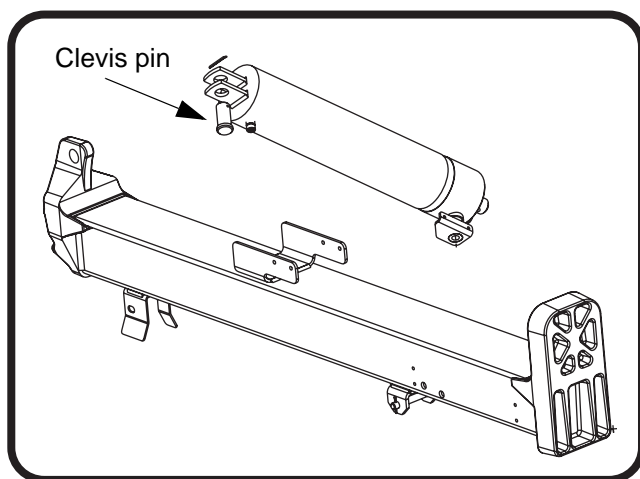

Figure 6.7

**NOTE:** The 33 ton models have a clevis pin held in place by a cotter pin at the base of the cylinder that must be removed. See Figure 6.7.

11. Lift the cylinder and control valve off of the log splitter.



The cylinder and wedge weighs 92 lbs or more depending on the model of the splitter.

## 2010 Log Splitters

12. Remove the log trays by removing screws that attach them to the beam using a 1/2" wrench. See Figure 6.8.

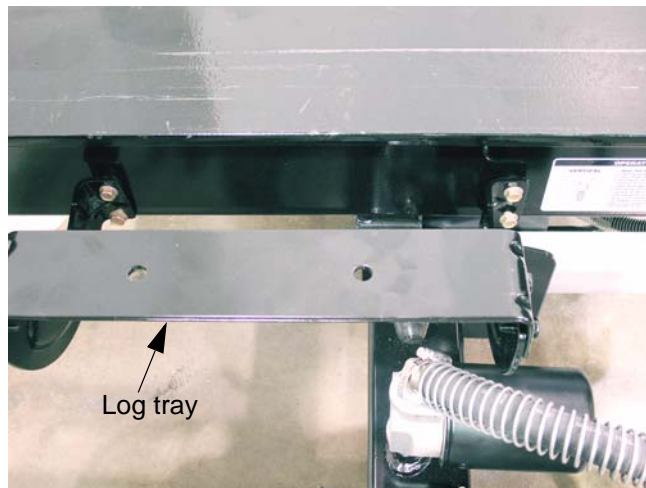

Figure 6.8

13. Pull on the locking pin and rotate it until it stays in the unlocked position.
14. Move the beam to the vertical position.



The beam weighs around 150 lbs. Take measures to prevent the beam from falling on the technician while separating it from the tank.

15. Remove the cotter pin from the pivot pin. See Figure 6.9.
16. Slide the pivot pin from the splitter.
17. Roll the tank assembly away from the beam.

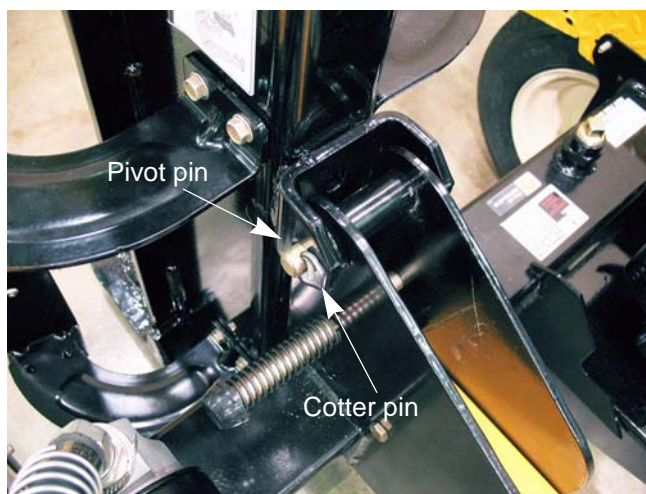

Figure 6.9

To install the beam:

18. Follow the previous steps in reverse order.

**NOTE:** Tighten the six nuts and bolts of the wedge and retainer plates to a torque of 38 - 53 ft lbs (52 - 72 Nm).

**NOTE:** When tightening hoses with O-ring face fittings, hold the hose so that the center part of it does not rotate against the O-ring while the swivel section is tightened. If the center part rotates, the O-ring can be damaged and it will leak under pressure.

19. Test run the log splitter in a safe area before returning it to service.

## CHAPTER 7: TANK AND TIRES

### Tank



Figure 7.1

To remove/replace the tank:

1. With the engine turned-off, relieve hydraulic pressure from the system by moving the lever on the control valve through its full range of travel.



Hydraulic fluid under high pressure can be dangerous. A high-pressure hydraulic fluid leak or spray can penetrate the skin. If this happens, seek immediate medical attention to reduce the risk of blood poisoning, which can lead to death or limb amputation.

2. Place a suitable container, large enough to hold all of the oil from the reservoir, under the suction hose. See Figure 7.1.



Figure 7.2

3. Remove the dip stick.
4. Loosen the hose clamp on the suction hose using a 5/16" wrench.
5. Remove the suction hose and drain the tank.
6. Remove the engine and pump.

Vertical shaft engines:

- 6a. Remove the engine and the pump by following the procedures described in Chapter 2: Engine and Pump.

Horizontal shaft engines:

- 6a. Disconnect the high pressure hose from the pump using a 15/16" wrench. See Figure 7.2.
- 6b. Remove the four engine mounting screws using a 9/16" wrench.
- 6c. Lift the pump and engine off of the splitter as one assembly.

## 2010 Log Splitters

7. Disconnect the return hose from the oil filter housing. See Figure 7.3.
8. Remove the oil filter housing by following the steps described in the oil filter housing section of this chapter.



Figure 7.3

9. Pull on the horizontal locking rod.  
**NOTE:** Some models have a horizontal locking rod that can be rotated until it stays in the unlocked position.
10. Move the beam to the vertical position.



The beam weighs around 150 lbs. Take measures to prevent the beam from falling on the technician while separating it from the tank.

11. Remove the cotter pin from the pivot pin. See Figure 7.4.
12. Slide the pivot pin from the splitter.
13. Roll the tank assembly away from the beam.

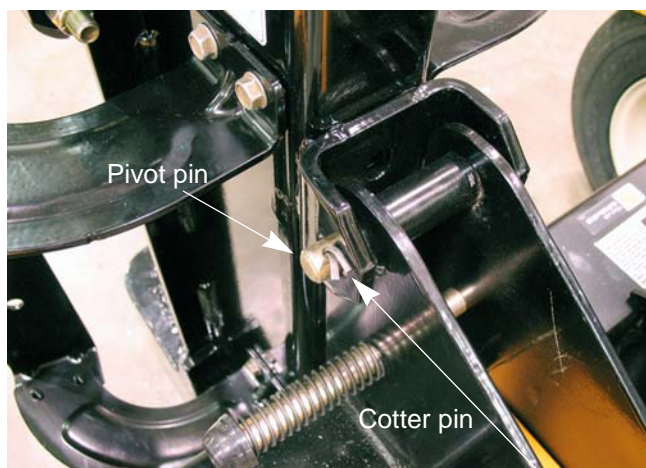
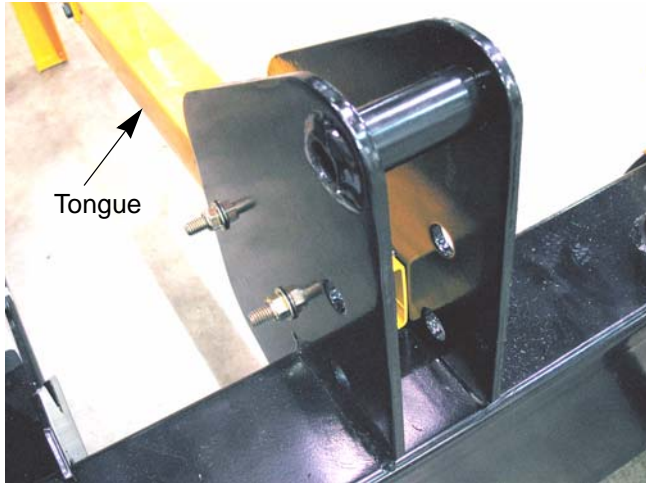

Figure 7.4





**Figure 7.5**

14. Remove the wheel assemblies by following the procedures described in the wheel assembly section of this chapter.
  15. Remove the fenders by following the procedures described in the fender section of this chapter.
  16. Remove the two nuts and bolt that hold the tongue to the tank using a pair of 9/16" wrenches. See Figure 7.5.
  17. Slide the tongue out of the tank.
  18. Remove the vertical locking rod by following the procedures described in the vertical locking rod section of this chapter.
- 
19. Install the tank by following the previous steps in reverse order.
  20. Fill the reservoir with either Dexron III ATF or SAE 10WAW (ISO 32 viscosity grade) hydraulic fluid. Do not mix the two.
  21. Start the log splitter.
  22. Cycle the ram 12 times to purge air from the hydraulic system.
  23. Test run the splitter in a safe area before returning it to service.

## 2010 Log Splitters

### Wheel assembly

To remove/replace the wheel assembly:

**NOTE:** The wheel bearings are covered in Chapter 8: Maintenance.

1. Lift and safely support the rear of the log splitter.
2. Pry off the dust cap. See Figure 7.6.



Figure 7.6

3. Remove and discard the cotter pin. See Figure 7.7.
4. Remove the wheel castle nut using a 1 1/8" wrench.
5. Remove the washer.
6. Slide the wheel assembly and bearings off of the spindle.

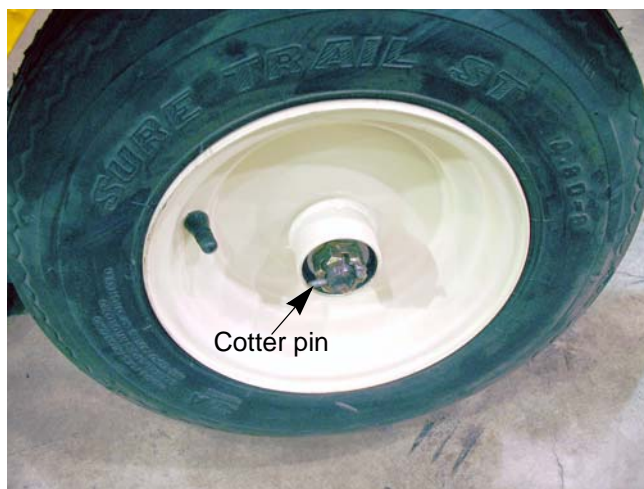

Figure 7.7

To install the wheel assembly:

1. Slide the wheel assembly and bearings onto the spindle.
2. Install the washer. See Figure 7.8.
3. Install the wheel castle nut. Tighten the nut until the bearings are fully seat while spinning the tire.
4. Back the nut off a 1/8 turn.

**NOTE:** The tire should spin freely and have no end play.

5. Install a new cotter pin
6. Install the dust cap.
7. Lower the splitter to the ground.
8. Test tow the splitter in a safe area before returning it to service.

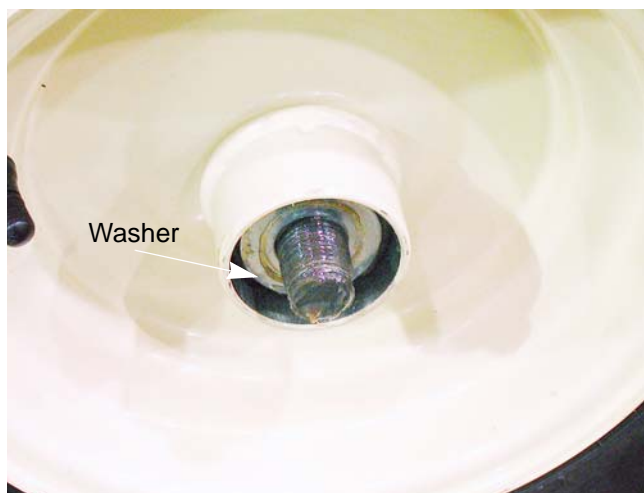
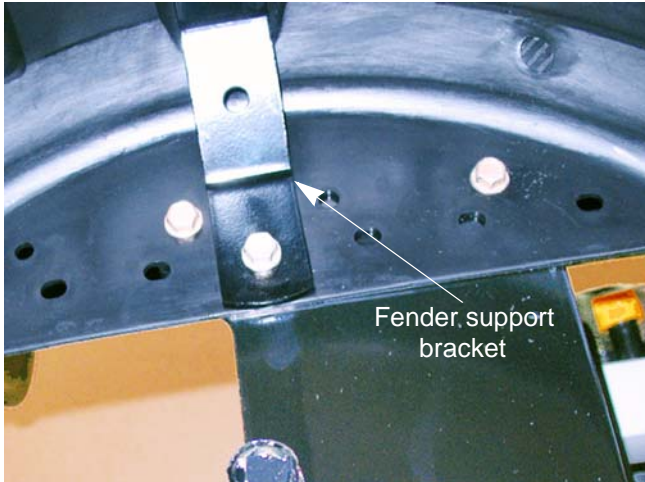

Figure 7.8

**Fenders**

There are a variety of fenders available for MTD log splitters. They can be broken down to two types of fenders; plastic or metal.

**Plastic fenders**



**Figure 7.9**

To remove/replace a plastic fender:

1. Remove the wheel by following the procedures described in the wheel assembly section of this chapter.
2. Remove the screw that passes through the fender support bracket and fender, threading into the tank. See Figure 7.9.
3. Remove both of the screws and washers that hold the fender to the tank using a 1/2" wrench.

If the fender is to be replaced:

4. Remove the screw and washer that hold the fender to the fender support bracket using a 1/2" wrench.

To install the fender:

1. Attach the fender support bracket to the fender.
- NOTE:** The fender support bracket has a square hole on the side that goes against the top of the fender.
2. Line up the bottom hole of the support bracket with the hole in the fender and the middle hole across the top of the tank. See Figure 7.10.

3. Install a screw without a washer.

**NOTE:** Do not tighten the screw all the way at this time.

4. Pivot the fender until the outer two holes of the top of the tank line up with two of the holes in the fender.

**NOTE:** There are a lot of bolt holes in the fender to accommodate all the different models of log splitters that MTD makes. To find the right bolt holes to use:

5. Install the two remaining screws and washer.
6. Tighten the screw that goes through the support bracket into the tank.
7. Install the wheel by following the procedures described in the wheel assembly section of this chapter.
8. Lower the splitter to the ground.
9. Test tow the splitter in a safe area before returning it to service.

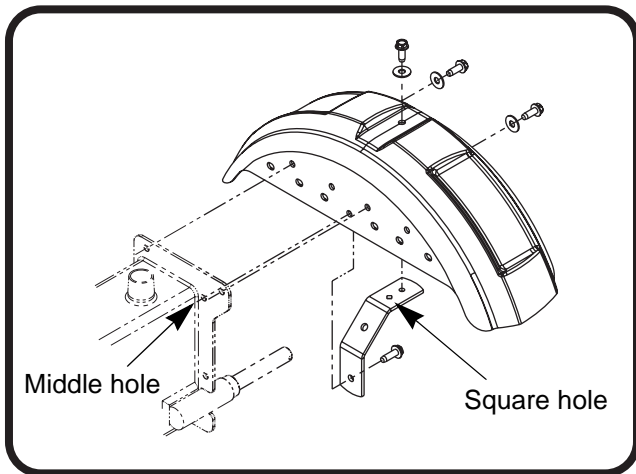

**Figure 7.10**

## 2010 Log Splitters

### Metal fender

To remove/replace a metal fender:

1. Remove the wheel by following the procedures described in the wheel assembly section of this chapter.
2. Remove both of the screws that hold the fender to the tank using a 1/2" wrench. See Figure 7.11.
3. Install the fender by following the previous steps in reverse order.

**NOTE:** The left and the right fenders have the same part number.

**NOTE:** There are a lot of bolt holes in the fender to accommodate all the different models of log splitters that MTD makes. To find the right bolt holes to use:

- Align the center bolt hole with the spindle.
- Slide the fender up and down until two of the bolt holes line up with the two holes in the tank.

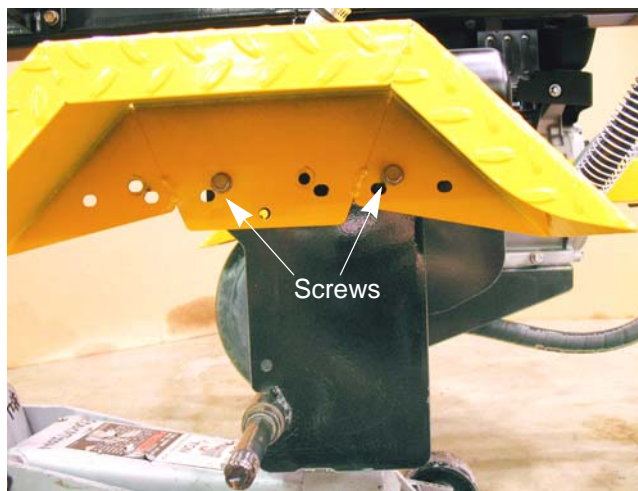

**Figure 7.11**

Oil filter housing



Figure 7.12

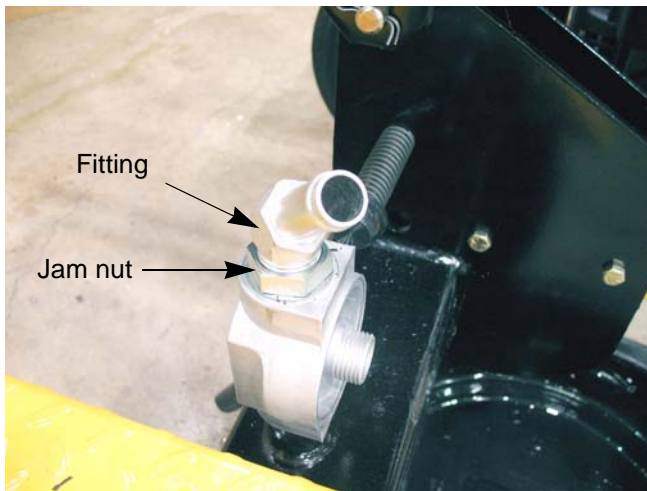

Figure 7.13



Figure 7.14

To remove/replace the oil filter housing:

1. With the engine turned-off, relieve hydraulic pressure from the system by moving the lever on the control valve through it's full range of travel.



Hydraulic fluid under high pressure can be dangerous. A high-pressure hydraulic fluid leak or spray can penetrate the skin. If this happens, seek immediate medical attention to reduce the risk of blood poisoning, which can lead to death or limb amputation.

2. Place a suitable container under the oil filter to catch any fluid that will spill. See Figure 7.12.

3. Remove the oil filter by turning it counter-clockwise and discard it.
4. Disconnect the return hose from the oil filter housing.
5. Remove the return hose fitting by:
6. Hold the fitting with a 1 1/16" wrench. See Figure 7.13.

7. Back off the jam nut with a 1 1/4" wrench.

**NOTE:** Some models may have a NPTF fitting.

8. Remove the fitting.
9. Remove the oil filter housing using a large adjustable wrench.

To install the oil filter housing:

1. Apply a small amount of Hydraulic thread sealant such as Loctite® 569 to the threads of the tank nipple. See Figure 7.14.

**NOTE:** DO NOT use teflon tape on any fitting on a MTD log splitter. Pieces of the tape can get into the system and damage the valve or the pump.

## 2010 Log Splitters

2. Thread the oil filter housing onto the tank nipple.

**NOTE:** There is an arrow cast into the oil filter housing. The arrow must be pointing to the tank. See Figure 7.15.

**NOTE:** A little bit of paint was rubbed on the housing to make the arrow more visible in the photo.

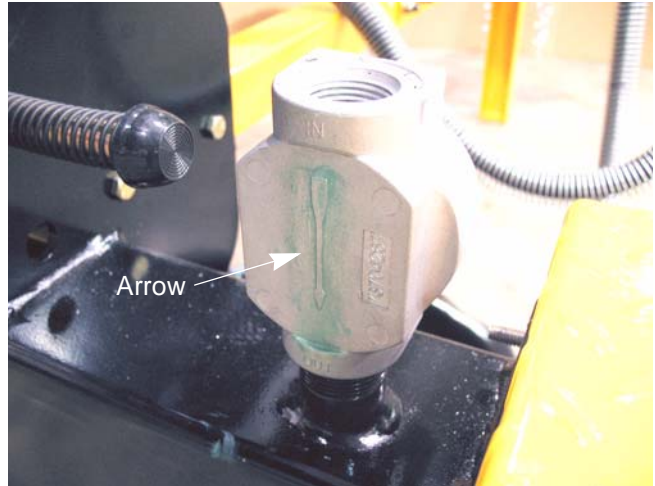

Figure 7.15

3. Thread the return line fitting into the oil filter housing hand tight.
4. Align the nipple on the fitting so that it is pointing to the front of the splitter at a 30° from the beam. See Figure 7.16.
5. Hold the fitting with a 1 1/16" wrench.
6. Tighten the jam nut with a 1 1/16" wrench until the O-ring is compressed.
7. Connect the return line to the fitting.
8. Place a light coat of oil on the oil filter O-ring.
9. Install the oil filter.
10. Check the oil reservoir level. Fill if necessary.
11. Test run the splitter in a safe area before returning to service.

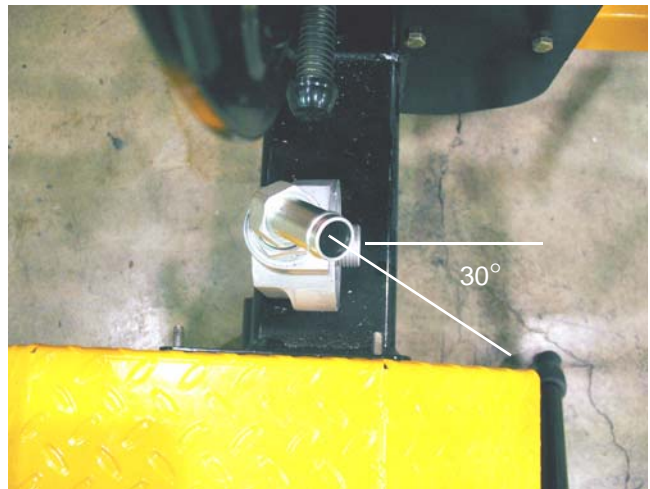
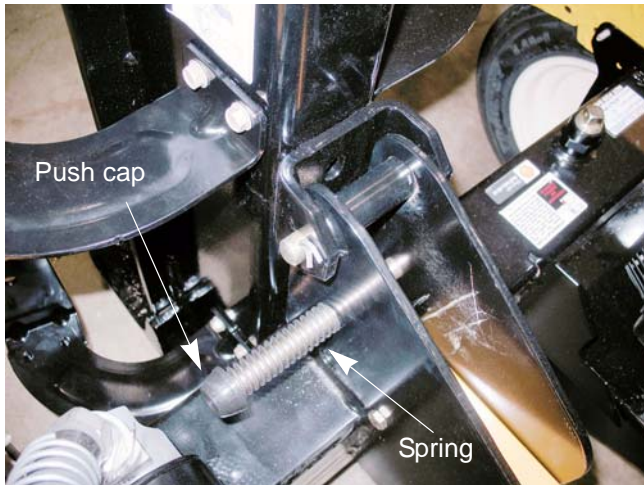

Figure 7.16

**Vertical locking rod**



**Figure 7.17**

To remove the vertical locking rod:

1. Pry the push cap off of the vertical locking rod. See Figure 7.17.
2. Remove the spring.
3. Slide the locking rod out of the uprights on the tank.

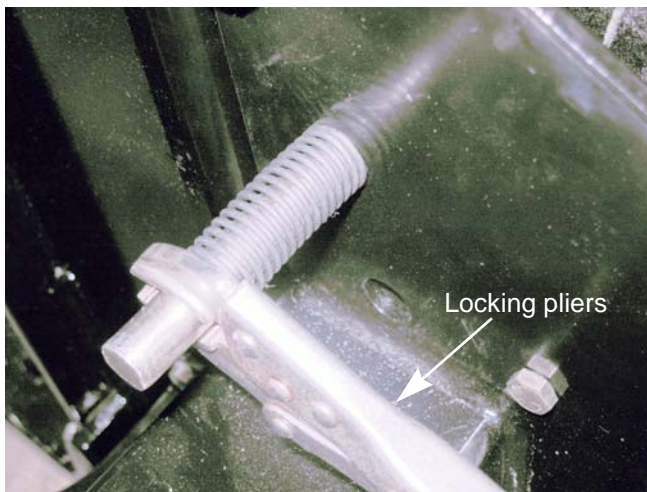

**Figure 7.18**

To install the vertical locking rod:

4. Slide the locking rod through the uprights on the tank from the engine side.
5. Slide the spring over the straight end of the locking rod.
6. Compress the spring and hold it in that position with a pair of locking pliers. See Figure 7.18.
7. Install the push cap onto the end of the locking rod.
8. Release the locking pliers.
9. Test the locking rod by moving the beam from vertical to horizontal and back a few time.
10. Test run the splitter before returning it to service.

## 2010 Log Splitters

### Horizontal locking rod

To remove/replace the horizontal locking rod:

1. Move the beam to the vertical splitting position.
2. Drive out the roll pin using a 1/8" pin punch.  
See Figure 7.19.
3. Pull the locking rod out of the bracket, catching the spring when the rod is removed.

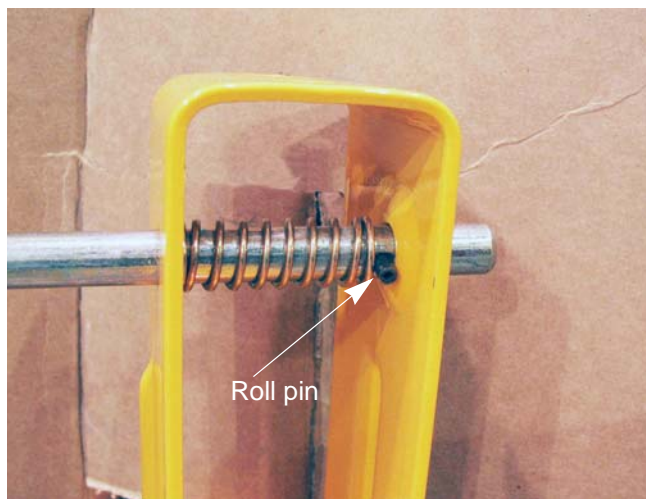

**Figure 7.19**

To install the horizontal locking rod:

4. Position the spring inside the lock rod bracket.
5. Slide the locking rod into the bracket and through the spring until the roll pin hole is outside the other side of the bracket.
6. Grip the locking rod between the spring and the inside of the bracket on the side with the roll pin hole with a pair of locking pliers. See Figure 7.20.
7. Pull the locking rod until the roll pin hole is inside the bracket.
8. Drive in the roll pin using a 1/8" pin punch.
9. Release the locking pliers.
10. Test the locking rod by moving the beam from vertical to horizontal and back a few times.
11. Test run the log splitter before returning it to service.

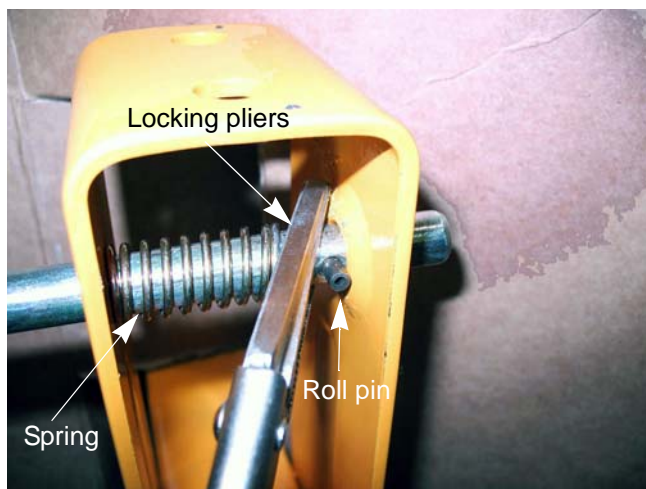

**Figure 7.20**



## CHAPTER 8: MAINTENANCE

### Lubrication

To help keep the MTD log splitter in proper running order, MTD recommends the following maintenance intervals be used (adjustable to local conditions).

Maintenance Point	Interval
Clean beam and wedge of debris	Every use
Oil the beam	Every use
Engine oil change	25 hours*
Hydraulic oil change	100 hours
Hydraulic oil filter	50 hours
Wheel bearings	varies with distance and speed towed

\* First oil change at 5 hours

### Beam and wedge

The beam and wedge should be cleaned and oiled every time the log splitter is used. To clean the beam and wedge:

1. Brush all dirt and debris out of the log dislodger.
2. Brush all dirt and debris off of the beam and from under the wedge.  
**NOTE:** Any debris trapped under the wedge can prevent the wedge from moving freely up and down the beam. This can result in failure of the wedge and damage the beam.
3. Put a small amount of engine oil on a shop rag or a paper towel.
4. Wipe the beam down with the oiled rag so that there is a light coat of oil on the beam.

## 2010 Log Splitters

### Engine maintenance

The recommended maintenance intervals listed in this manual are a guideline. They are adjustable for local conditions.

Maintenance items	Interval
Oil Change*	25 hrs
Replace the air filter	25 hrs
Spark plugs	100 hrs
Fuel filter	100 hrs
Clean the engine	25 hours

**\* First oil change at 5 hours.**

Please refer to the engine service manual for specific engine maintenance procedures.

### Clean the engine

Air cooled engines cool better if they are clean. Check for nesting or signs of nesting especially after dormant season storage.

### Fuel system

What you should know about fuel.

Most of the fuel presently available in North America is oxygenated to some extent. This is commonly done through the addition of ethanol. Most engines offered for sale on outdoor power equipment in the North American markets are designed to tolerate no more than 10% ethanol by volume

Ethanol is hygroscopic, meaning it absorbs water. If left exposed to air, it will draw water out of the air.

Ethanol is an oxygenator, which means that it will oxidize (corrode) metal that it comes into contact with. Exposure to air causes fuel to go bad quickly, leaving gum and varnish deposits.

Methanol is another type of alcohol that is used to oxygenate fuel. Fuel that contains 5% methanol can be used as long as it also contains co-solvents and corrosion inhibitors to protect the fuel system. Fuel with more than 5% methanol will cause starting and/or performance problem. It will also cause damage to the metal, rubber and plastic components of the fuel system.

Fuel used in MTD outdoor power equipment should be no more than 30 days old. Because it may already have been stored at the refinery or gas station for a week or more, fuel should be purchased in small quantities and stored in safety approved gas cans with the caps closed.

For storage, all fuel should be run out of the tank and engine. Anti-oxidation additives will help keep the fuel fresher.

### Servicing the fuel system

Inspect the fuel system every time the log splitter is operated. If dirty fuel is found in the fuel tank or fuel that does not smell "right", drain the fuel tank and replace the fuel filter

Refer to the engine service manual for the procedure to service the fuel system.



Gasoline and its vapors are extremely flammable. Use common sense when working around the fuel system. Avoid sparks, open flames or heat sources that can ignite the fuel vapors.

**Engine oil**

Currently there are four engines available for the MTD log splitter. A generic oil change procedure will be described in this manual. For specific instructions, refer to the engine service manual.

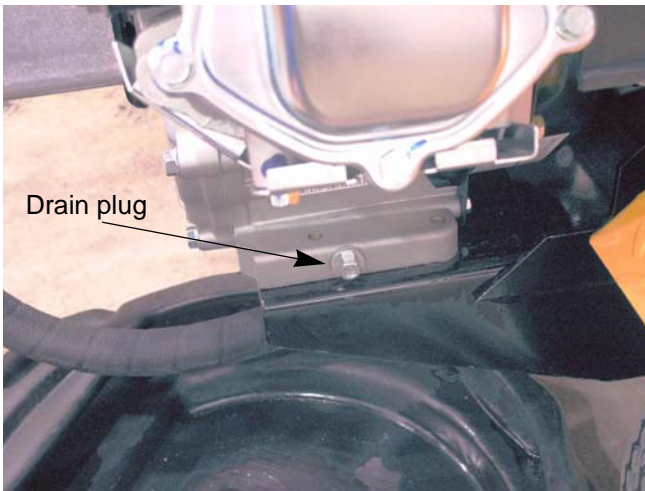

**Figure 8.1**

To change the oil:

1. Clean around the base of the engine.
2. Place a suitable container under the engine to catch the oil.
3. Remove the drain plug. See Figure 8.1.
4. Remove the dip stick.
5. When the oil stops draining, install the drain plug.
6. Fill the engine with oil.
7. Install the dip stick.
8. Test run the log splitter before returning it to service

**Oil type and quantity**

Use a quality SAE 10W30 motor oil certified to meet or exceed American Petroleum Institute (A.P.I.) requirements for service classification SM. Motor oils classified SM will show this designation on the container. Synthetic oil is a suitable alternative, but it does not extend service intervals.

**NOTE:** MTD recommends the use of petroleum oil during the break in period to ensure the piston rings break in correctly.

**NOTE:** Synthetic vs. Petroleum based oil: To simply look at synthetic oil and to compare it with Petroleum based oil there is very little difference. However, when you look at the two through a microscope it is easy to see the difference. Synthetic is made up of smaller molecules. This allows the oil to get into areas that petroleum based oil cannot.

The engine oil capacities are listed in the chart below.:

**Engine oil capacities:**

Engine model number	Oil capacity
1P70L0	20 oz (0.6 L)
170-L0	20 oz (0.6 L)
178-L0	30 oz (0.9 L)
GCV160LA0	19 oz (0.55 L)

## 2010 Log Splitters

### Hydraulic oil

The MTD log splitter has an open vent in the dip stick plug. This leave the hydraulic oil in the reservoir open to collect dirt and water from the atmosphere. Because of this, the hydraulic oil should be changed ever 100 hours.

To change the hydraulic oil:

**NOTE:** The oil filter should be changed at the same time the hydraulic oil is changed.

1. With the engine turned-off, relieve hydraulic pressure from the system by moving the lever on the control valve through its full range of travel.



Hydraulic fluid under high pressure can be dangerous. A high-pressure hydraulic fluid leak or spray can penetrate the skin. If this happens, seek immediate medical attention to reduce the risk of blood poisoning, which can lead to death or limb amputation.

2. Place a suitable container, large enough to hold all of the oil from the reservoir, under the suction hose.
3. Clean the tank area of dirt and debris.
4. Remove the dip stick plug.
5. Loosen the hose clamp on the suction hose using a 5/16" wrench.
6. Remove the suction hose and drain the tank. See Figure 8.2.
7. Once the oil stops draining from the tank, install the suction hose.
8. Tighten the hose clamp using a 5/16" wrench.
9. Remove and discard the hydraulic oil filter by turning it counter-clockwise.
10. Coat the O-ring of the new oil filter with a light coat of oil.
11. Thread the oil filter onto the oil filter housing hand tight.
12. Fill the reservoir with either Dexron III ATF or SAE 10WAW (ISO 32 viscosity grade) hydraulic fluid. Do not mix the two.

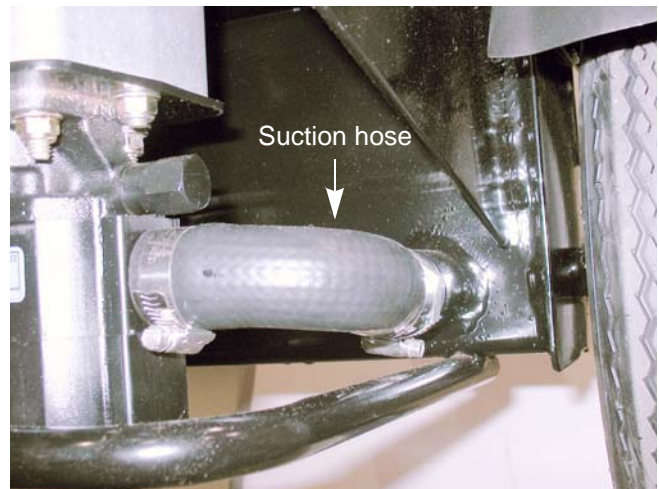

**Figure 8.2**

**NOTE:** Models that are produced pre-filled, are filled with 10WAW (ISO 32).

**NOTE:** The reservoir will hold 3 or 5 gallons depending on the model.

13. Install the dip stick plug.
14. Start the log splitter.
15. Cycle the ram 12 times to purge air from the hydraulic system.
16. Test run the splitter in a safe area before returning it to service.

### Wheel bearings

The wheel bearing on the MTD log splitter will need to be serviced from time to time. The frequency of how often they need to be serviced depends on how the splitter is towed. A splitter that was towed home from the store and parked in the yard, never moving, will not need to have the bearings serviced as often as the splitter that gets towed from job site to job site. A splitter towed on roads will need to be serviced more often than a splitter towed across the yard by a lawn tractor.



Figure 8.3



Figure 8.4

To service the wheel bearings:

**NOTE:** A bearing cone and race will wear into each other, becoming a matched set. When servicing the bearings, The cones must go back to the same race they came out of. If a cone or a race is worn or damaged, the cone and race must be replaced as a set.

1. Remove the wheel assemblies by following the procedures described in Chapter 7: Tanks and Tires.

**NOTE:** All four wheel bearings should be serviced at the same time.

2. Remove the outer bearing cone from the wheel. See Figure 8.3.

3. Remove the grease seal from the inboard side of the wheel. See Figure 8.4.

4. Remove the bearing cone.

## 2010 Log Splitters

5. Clean and inspect the bearing races.

**NOTE:** If there are signs of wear or damage to a bearing race, it and its matching cone must be replaced.

**NOTE:** To replace a race:

- Drive the old race out using a flat tipped punch.
- Clean the old grease out of the wheel assembly.
- Carefully drive in the new race(s) using a bearing race driver. See Figure 8.5.

6. Clean and inspect the bearing cones.

**NOTE:** If there are signs of wear or damage to a bearing cone, it and its matching race must be replaced.

7. Place a glob of grease in the palm of your hand.

**NOTE:** Use Alvania EP 2 or equivalent lithium based grease.

8. Work the bearing cone into the grease until grease ejects out of the top of the bearing (all the way around the bearing). See Figure 8.6.

9. Coat the outer surface of the bearing cones with grease.

10. Install the inboard bearing cones in the wheel assemblies.

11. Install the grease seals.

12. Coat the area inside the wheel assemblies between the bearing races with grease.

13. Install the outboard bearing cones.

14. Install the wheels by following the procedures described in Chapter 7: Tank and Tires.

15. Test tow the splitter in a safe area before returning it to service.

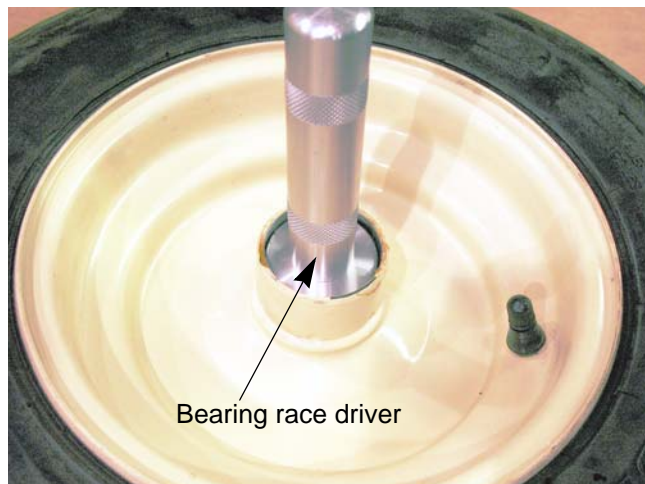

Figure 8.5



Figure 8.6

For Parts Call 606-678-9623 or 606-561-4983

[www.mymowerparts.com](http://www.mymowerparts.com)

For Parts Call 606-678-9623 or 606-561-4983

***MTD Products Inc - Product Training and Education Department***

FORM NUMBER - 769-06184

07/2010

[www.mymowerparts.com](http://www.mymowerparts.com)