

CHAIN SAW OPERATOR'S SAFETY MANUAL

A CHAIN SAW IS DESIGNED TO CUT WOOD, AND CAN BE DANGEROUS. CARELESS OR IMPROPER USE CAN CAUSE SERIOUS OR EVEN FATAL INJURY.

IT IS IMPORTANT THAT YOU FULLY UNDERSTAND THE CONTENTS OF THIS MANUAL, AND THAT YOU ALLOW ONLY COMPETENT ADULTS WHO UNDERSTAND THE INFORMATION IN THIS MANUAL TO OPERATE YOUR CHAIN SAW. IT IS YOUR RESPONSIBILITY TO MAKE SURE THAT ANY PERSONS WHO USE YOUR CHAIN SAW HAVE READ AND UNDERSTOOD THIS MANUAL.

SAFETY PRECAUTIONS

(ANSI B 175.1 - 2000 Annex C)

Safety precautions for chain saw users*

C 1. Kickback safety precautions

 **WARNING!**

KICKBACK may occur when the nose or tip of the guide bar touches an object, or when the wood closes in and pinches the saw chain in the cut.

- Tip contact in some cases may cause a lightning fast reverse REACTION, kicking the guide bar up and back towards the operator.
- Pinching the saw chain along the top of the guide bar may push the guide bar rapidly back towards the operator.
- Either of these reactions may cause you to lose control of the saw which could result in serious personal injury.

Do not rely exclusively upon the safety devices built into your saw. As a chain saw user, you should take several steps to keep your cutting jobs free from accident or injury.

- (a) With a basic understanding of kickback, you can reduce or eliminate the element of surprise. Sudden surprise contributes to accidents.
- (b) Keep a good firm grip on the saw with both hands, the right hand on the rear handle, and the left hand on the front handle, when the engine is running. Use a firm grip with thumbs and fingers encircling the chain saw handles. A firm grip will help you reduce kickback and maintain control of the saw. Don't let go.
- (c) Make sure that the area in which you are cutting is free from obstacles. Do not let the nose of the guide bar contact a log, branch, or any other obstacle which could be hit while you are operating the saw.
- (d) Cut at high engine speeds.
- (e) Do not overreach or cut above shoulder height.
- (f) Follow manufacturer's sharpening and maintenance instructions for the saw chain.
- (g) Only use replacement bars and chains specified by the manufacturer or the equivalent.

C 2. Other Safety Precautions

 **WARNING!**

Do not operate a chain saw with one hand! Serious injury to the operator, helpers, bystanders or any combination of these persons may result from one-handed operation. A chain saw is intended for two-handed use.

- (a) Do not operate a chain saw when you are fatigued.
- (b) Use safety footwear; snug-fitting clothing; protective gloves; and eye, hearing, and head protection devices.
- (c) Use caution when handling fuel. Move the chain saw at least 10 feet (3 m) from the fueling point before starting the engine.
- (d) Do not allow other persons to be near the chain saw when starting or cutting with the chain saw. Keep bystanders and animals out of the work area.
- (e) Do not start cutting until you have a clear work area, secure footing, and a planned retreat path from the falling tree.
- (f) Keep all parts of your body away from the saw chain when the engine is running.
- (g) Before you start the engine, make sure that the saw chain is not contacting anything.
- (h) Carry the chain saw with the engine stopped, the guide bar and saw chain to the rear, and the muffler away from your body.
- (i) Do not operate a chain saw that is damaged, improperly adjusted, or not completely and securely assembled. Be sure that the saw chain stops moving when the throttle control trigger is released.
- (j) Shut off the engine before setting the chain saw down.
- (k) Use extreme caution when cutting small size brush and saplings because slender material may catch the saw chain and be whipped toward you or pull you off balance.
- (l) When cutting a limb that is under tension be alert for springback so that you will not be struck when the tension in the wood fibers is released.
- (m) Keep the handles dry, clean, and free of oil or fuel mixture.
- (n) Operate the chain saw only in well-ventilated areas.
- (o) Do not operate a chain saw in a tree unless you have been specifically trained to do so.
- (p) Do not operate a chain saw above shoulder height.
- (q) All chain saw service, other than the items listed in the operator's/owner's safety and maintenance instructions, should be performed by competent chain saw service personnel. (For example, if improper tools are used to remove the flywheel or if an improper tool is used to hold the flywheel in order to remove the clutch, structural damage to the flywheel could occur and subsequently cause the flywheel to burst.)
- (r) When transporting your chain saw, use the appropriate guide bar scabbard.

Note: This Annex is intended primarily for the consumer or occasional user.

* Reprint of American National Standards Institute (ANSI), Annex C B 175.1 – 2000

TABLE OF CONTENTS

SAFETY PRECAUTIONS	2
TABLE OF CONTENTS	3
GENERAL SAFETY	4
INTRODUCTION	
Chain Saw Operator	5
Manuals	6
Personal Equipment.....	6-7
Required Tools.....	8
CHAIN SAW SAFETY FEATURES	
General	9
Safety Features.....	9-10
Cutting Equipment	12-14
POTENTIAL DANGERS	
Severe Laceration	15
What is Kickback?	16-17
Avoiding Kickback	18-19
Avoiding Kickback – Your Equipment	20-21
Carbon Monoxide Poisoning	22
Hearing Loss	22
Vibration Injury	23
Crushing, Fracture or Puncture	24
Burns, Fire	25
BEFORE STARTING/AFTER STARTING	
Safety Check.....	26-28
Carrying the Saw	28
Starting the Saw	29
Holding the Saw	30
After Starting the Saw	30
Stopping the Saw	30
BASIC WORKING TECHNIQUES	
General Rules	31
Reactive Forces	31
Boring Cut	32
Felling	33-35
Lodged Trees	36-37
Limbing	37
Cutting Logs	38
Cutting Shrubs, Brush, etc	39
Cutting Trees or Limbs under Tension	40

GENERAL SAFETY

Safety symbols

The following safety symbols are found throughout this manual and are designed to make you aware of potential hazards or unsafe practices.



WARNING

WARNING - Hazards or unsafe practices which can cause serious or fatal injury to the operator or others.



CAUTION

CAUTION - Hazards or unsafe practices which can result in personal injury.



IMPORTANT

IMPORTANT - Hazards or unsafe practices which can result in product or property damage.

General Safety Precautions



WARNING

Chain saws are solely designed to cut wood, and can be a dangerous tool if used carelessly or incorrectly and can cause serious, even fatal injuries to the operator or others.

It is important that you fully understand the contents of this manual, and that you allow only competent adults who understand the information in this manual to operate your chain saw. It is your responsibility to make sure that any people who use your chain saw have read and understood this manual.



WARNING

Do not modify the equipment for any reason. Altering the chain saw can result in operator injury or equipment failure.

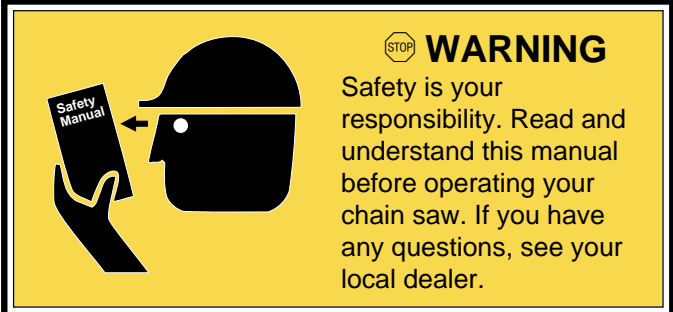

WARNING

Safety is your responsibility. Read and understand this manual before operating your chain saw. If you have any questions, see your local dealer.



WARNING

Never use equipment that is not functioning properly. If your chain saw is not working properly, have the saw repaired by qualified service personnel.



WARNING

Wear protective equipment when working. Never wear loose clothing or jewelry that can get caught in moving parts.



CAUTION

Perform safety check before starting each day.



CAUTION

Know the requirements of each job and the terrain before using a chain saw.

INTRODUCTION

For the Casual or Occasional Operator

This manual is primarily intended for the casual or occasional operator. These instructions are basic. It is not possible to cover every situation you may encounter while using your chain saw. Be careful at all times and avoid situations that may be too complicated for your experience. If you are unsure of a cutting situation, call a logging expert before continuing. We encourage you to seek instruction on the use of chain saws. Your local dealer, forestry school or library can tell you what instructional material and training courses are available. The better prepared you are, the better and safer operation you will get from your chain saw.

Use common Sense

Your chain saw can be a very dangerous tool if improperly or carelessly used or if improperly equipped or maintained. Use common sense and caution at all times. Avoid situations that may be too dangerous or complicated for you. If you still feel you do not understand the dangers of using a chain saw after having read these instructions, you should not use the saw. Seek personal instruction from people qualified to instruct you on the use of chain saws. Should you have more questions about the use of your saw, don't hesitate to contact your dealer or us. We will be more than happy to provide you with any advice that will help you to use your saw in a better and safer way. New designs and techniques are introduced continuously – designs that will increase your safety and productivity. Make a point of



INTRODUCTION

Manuals

Your chain saw comes with two instruction manuals. This **Safety Manual** contains general information in how to operate your chain saw in a safe way.

The **Operator's Manual** gives specific information on the technical design and maintenance regarding your particular model.

Read both manuals very carefully before operating a chain saw.

We continuously strive to improve all of our products. As a result, engineering changes and improvements are made from time to time. Written notices relating to such changes are sent to our dealers. Make a point of asking your chain saw dealer to show you the latest design.



WARNING

Under no conditions should the chain saw be modified from its original design without permission of the manufacturer. Nonauthorized accessories should never be used. Nonauthorized modification and/or accessories can cause serious injury or death to the operator or others.

Personal Equipment

Your Condition

Never operate a chain saw when you are tired, angry, emotionally disturbed, or under the influence of alcohol, drugs, medication, or anything that could affect your vision, alertness, coordination or judgment. Cutting wood can be strenuous - check with your doctor before undertaking this kind of work.

Clothing

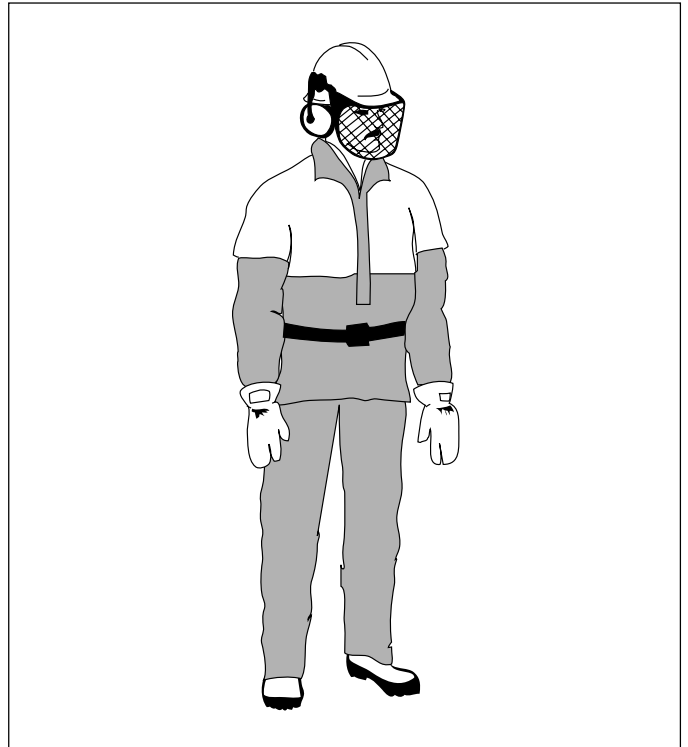

Wear proper clothing and equipment intended to protect you from potential hazards such as lacerations, thrown objects, and hearing loss.

IMPORTANT

The personal safety equipment cannot prevent an accident but use of good personal protective equipment may minimize an injury in the event of an accident.

Ask your dealer to show you the latest safe forestry equipment available to help protect you. A complete helmet with visor and earmuffs and protective pants or chaps, are examples.

Wear clothing that keeps you warm and comfortable, and, therefore, safer in adverse weather.

Never wear loose fitting clothing, jewelry, etc., which could become entangled in the saw and cause serious injury.

INTRODUCTION

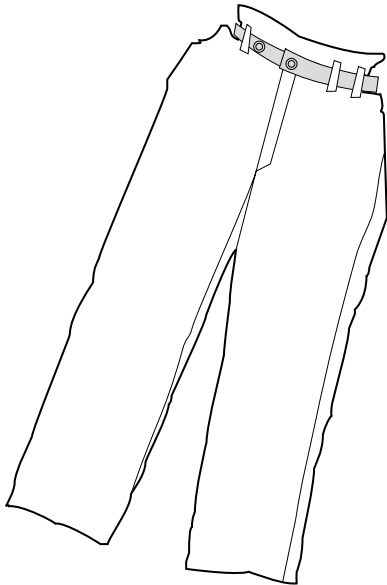
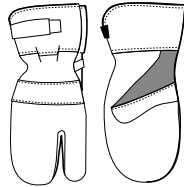
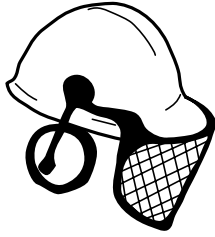

IMPORTANT

We strongly recommend the use of the following protective equipment at any time you use your chain saw. Because safety records prove a decrease in injuries when this equipment is used, most professional logging operations now demand that their operators wear these items. Take advantage of their experience. Your dealer will gladly assist in finding the right protective equipment for you.

Complete Protective Helmet

This consists of a lightweight helmet, built-in earmuffs and a face shield. Its main advantage is that everything needed is one piece rather than three. As the earmuffs are attached to the helmet, they also help in keeping the helmet more secure on your head. The earmuffs are designed to reduce the risk for hearing injuries. As they shield you from the noise of the chain saw they may also block other sounds such as the sound of a tree breaking or shouts from fellow workers. Therefore, you must stay visually alert all the times.

The helmet or hard hat is intended to reduce risk of injuries from objects that may fall from a tree. Earmuffs reduce the risk of hearing injuries that can be the result of operating any noisy equipment over a prolonged period of time. The face shield protects the face from strikes from small branches and eyes from saw chips and dust.

The mesh in the face shield many logging helmets are equipped with, is intended to protect your face from branches, twigs and saw dust generated during cutting. It is not strong enough to protect you eyes from sharp particles that may be thrown at you. Therefore, we also recommend you also wear protective goggles.

Heavy Duty Gloves

Special gloves are available where the left glove is reinforced to help reduce injuries should your left hand inadvertently touch a rotating chain.

Protective Pants

The protective material used in modern protective pants consists of several layers or synthetic fabric. Should you inadvertently hit your leg with a running saw chain, protective pants may reduce the injury.

Boots

Special work boots with reinforced front and upper sides are available for loggers. Should you inadvertently hit the boot with the saw, these protective boots may reduce the injury.

First Aid Kit

A first aid kit approved by the Red Cross or an organization of similar stature should always be carried in case of injury in the field.

A kit should contain large dressings for lacerations, splints and slings for fractures, antiseptic and other optional items for your safety and convenience, such as insect repellent and a snake bite kit.

INTRODUCTION

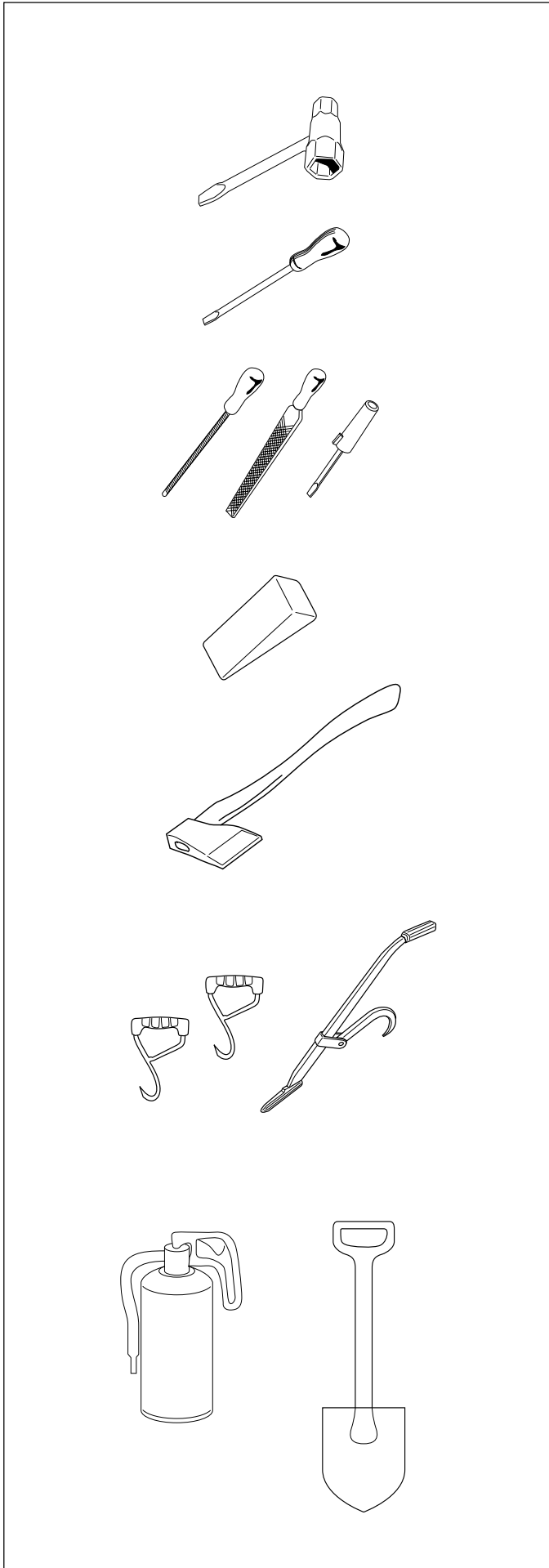

Required Tools

The following items are needed for routine, everyday, safe operation and maintenance of a chain saw.

T-Wrench

Needed to adjust chain tension.

Small Screwdriver

Used to adjust carburetor.

Files

One round file with file holder to sharpen cutting edge of chain, and one flat file and depth gauge tool for filing the depth gauge.

Wedge

At least one non-metal wedge to prevent pinching of the bar or to help properly remove a stuck saw.

Axe

Useful for trimming and clearing work that is hazardous, or not recommended for a chain saw.

Felling Lever and Hook

The felling lever is used to assist in felling a tree. The hook can be used to move a felled tree.

Fire Extinguisher and Shovel

Used to extinguish fires.

IMPORTANT

Use caution in dry conditions. A chain saw can generate sparks hot enough to ignite dry grass or chips. The sparks can come from the muffler, the bar and chain or other sources. Check with local agencies to ensure your chain saw meets all local requirements. Avoid using your chain saw in extremely dry conditions or when fire warnings are posted.

Always have fire extinguishing tools available should you need them. Help prevent forest fires.

CHAIN SAW SAFETY FEATURES

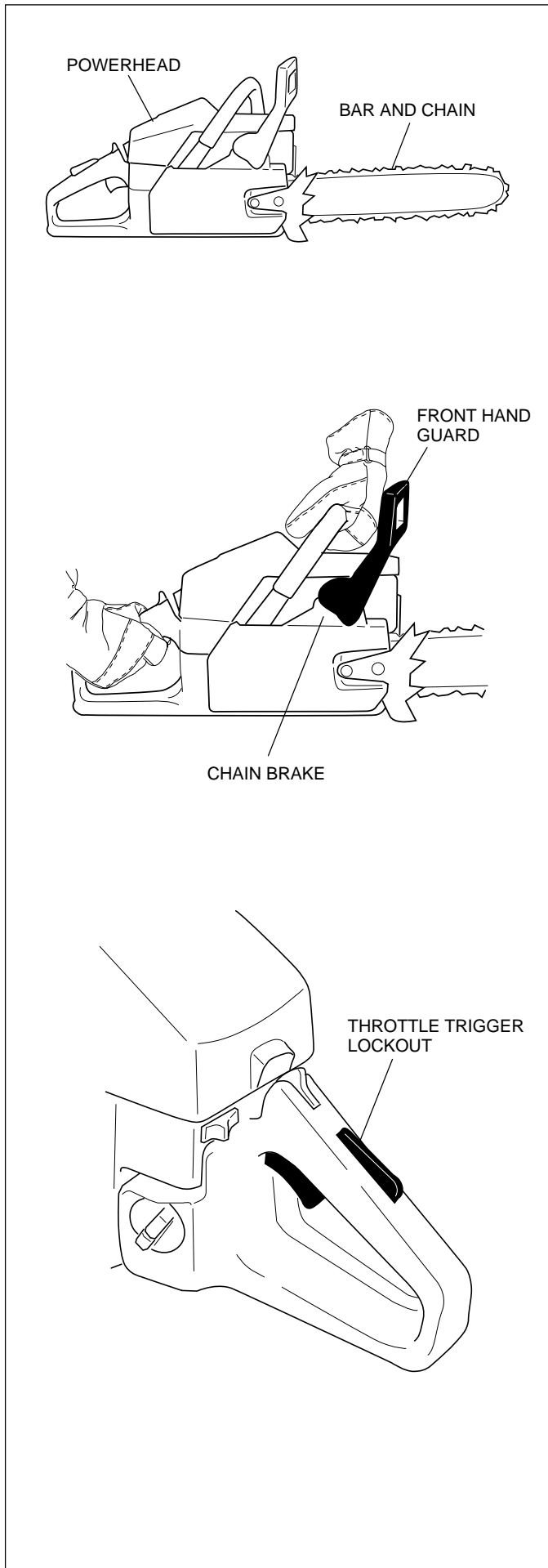

General

A chain saw has two parts, the **engine or powerhead** and the **cutting equipment** (bar and chain).

Adjustment and maintenance of the powerhead and its major components can be found in the Operator's Manual.

The chain saw safety features are shown and described below. Check them and their function before each use.

Safety Features

Front Hand Guard

Activates the chain brake if moved forward. Resets the chain brake when moved backwards toward the front handle. Also designed to reduce the risk of your hand touching the saw chain if your hand slips off the front handle.

Chain Brake

The chain brake is designed to stop the saw chain if activated while the saw chain is running, or can act as a "parking brake" while the chain saw is idling to help prevent the saw chain from moving.

Throttle Trigger Lockout

Designed to prevent the accidental operation of the throttle. The throttle is locked in the idling position when the lockout is not pushed in by the operator's right hand.

CHAIN SAW SAFETY FEATURES

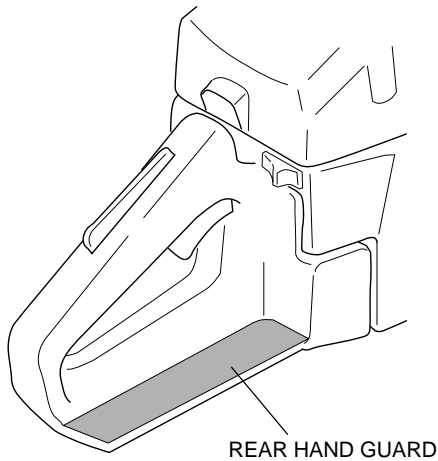

Rear Hand Guard

The lower part of the rear handle is designed to reduce injury by protecting the operator's hand in the event of chain breakage.

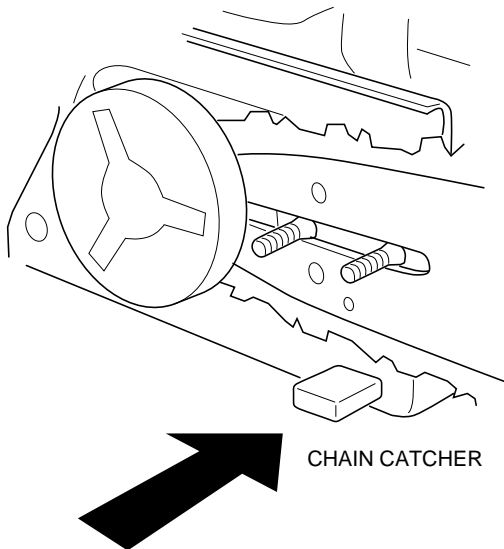

Chain catcher

Located under the chain as far forward as is practically possible, and designed to catch a broken or jumping chain.

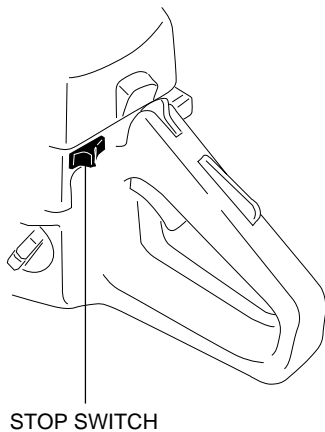

Stop Switch

Used to stop the engine.

CHAIN SAW SAFETY FEATURES

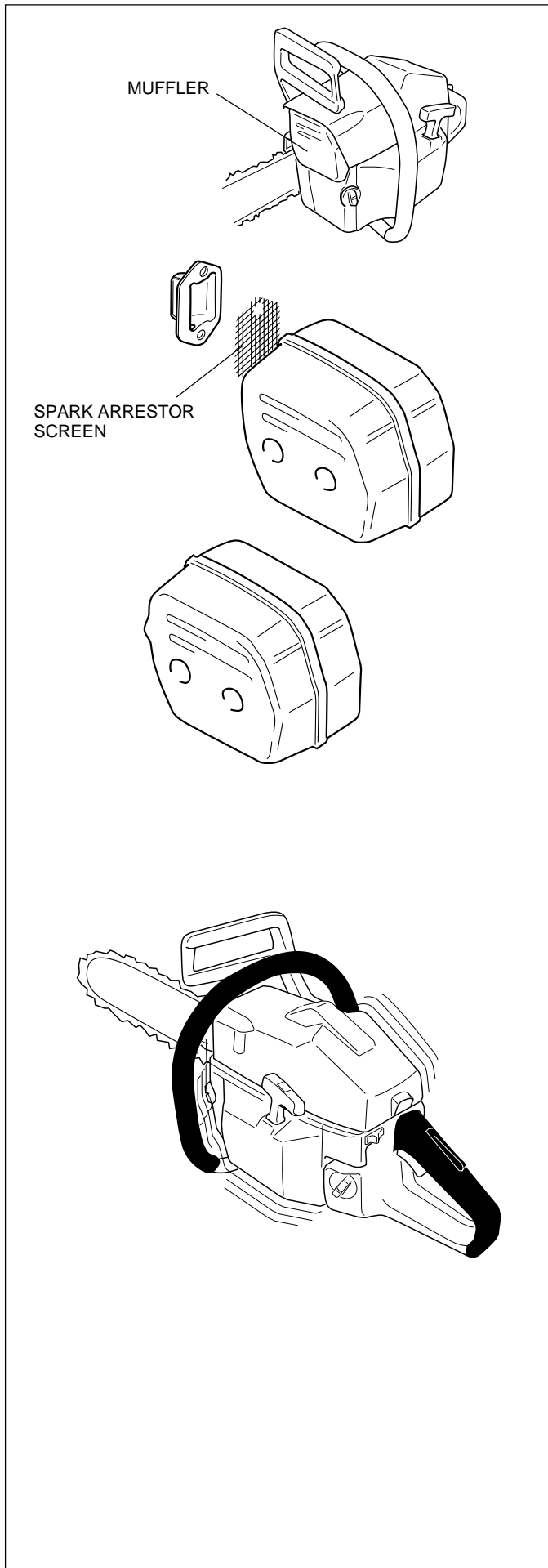

Muffler

Designed to decrease noise level and direct exhaust gases away from the operator. During operation the muffler is hot. Do not touch.

Spark Arrestor

The exhaust gases are hot, and can contain sparks which may cause fire if directed against dry and combustible material. To minimize the risk for forest fires your chain saw is equipped with a spark arresting screen that will prevent sparks (glowing carbon particles) of a certain size to leave the muffler. Over a period of time the particles will clog up the screen. If the screen is not cleaned, the particles will restrict the exhaust and your chain saw will lose power. Follow the instructions in the Operator's Manual when removing and cleaning the screen. We recommend that you always have the spark arrestor screen installed. Help prevent forest fires.

In certain states the spark arrestor is mandatory. Never use your chain saw without a spark arrestor screen if required in your area.

⚠ CAUTION

Never use a saw without a muffler, or with a damaged muffler. A damaged muffler may substantially increase the noise level and the fire hazard. Keep fire fighting equipment handy. If a spark arrestor screen is required in your area, never use the saw without or with a broken spark arrestor screen.

Vibration Isolator

Located between the engine unit and the handle unit. Reduces operator's exposure to vibration.

IMPORTANT

The isolators should be checked for cracks and deformation. Ask your dealer to perform this function twice a year or when you suspect an element has been damaged.

Heated Handles

Saw models with heated handles are available and will keep your hands warm during cold days.

CHAIN SAW SAFETY FEATURES

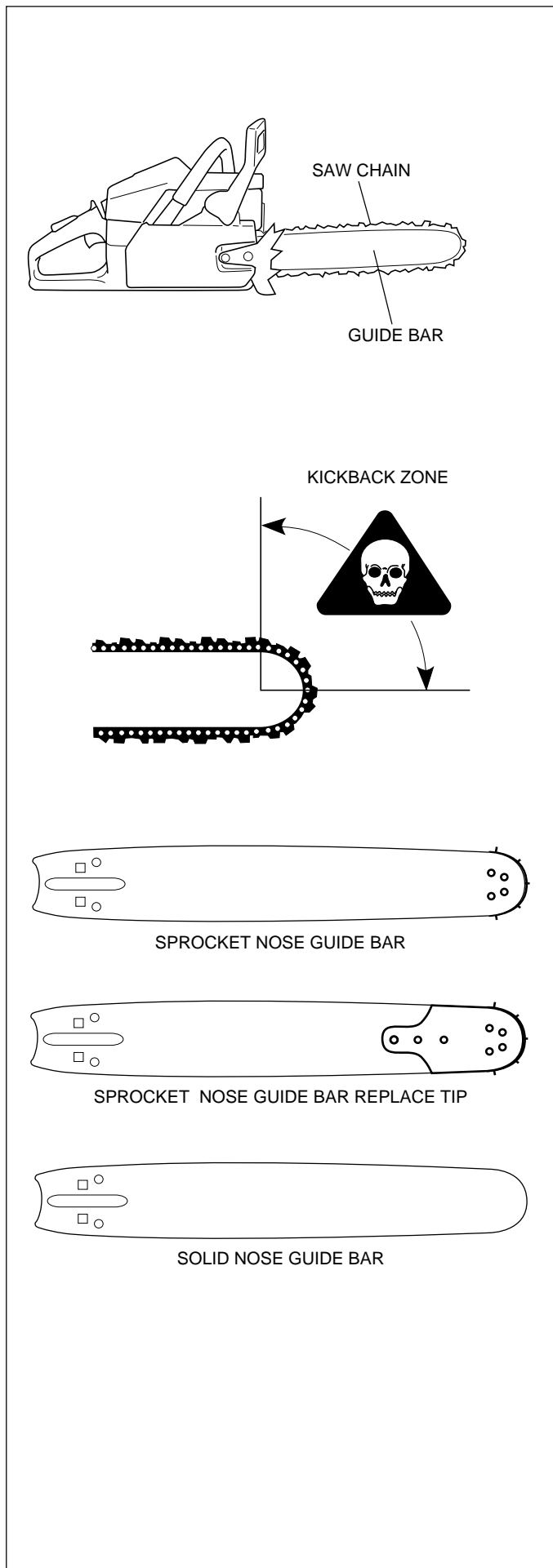

Cutting Equipment

The cutting equipment consists of a **guide bar** and **saw chain**. There are several different manufacturers of guide bars and saw chains. Each manufacturer produces several different types, and each type is available in different lengths.

The warning labels on the saw refer to ANSI B175.1-2000 Kickback Requirements. Saws complying with these requirements have a low kickback tendency as long as the recommended bar and saw chain combination is used. The bar and chain combination is vital to your chain saw's kickback propensity. Your Operator's Manual lists bar and chain recommendations for your saw which comply with the requirements. We strongly recommend that you only use approved combinations unless you have extraordinary cutting needs, experience, and specialized training in dealing with kickback.

Straight Guide Bars

Guide bars come in many different types and shapes. The design of the nose radius is especially important. The smaller the radius, the smaller the kickback zone. The smaller the kickback zone, the less likely a kickback will occur. A smaller radius also decreases the kickback force. The guide bar nose radius is determined by either the number of teeth in the sprocket nose (for example: 10T, the lower the number, the smaller the radius) or corresponding nose radius of a solid nose bar.

Your Operator's Manual recommends bars with a small nose radius. The Operator's Manual lists the maximum nose radius which should be used. You may use a guide bar with smaller nose radius than listed.

IMPORTANT

We strongly recommend using only the type of guide bar specified for your saw by the Operator's Manual.

CHAIN SAW SAFETY FEATURES

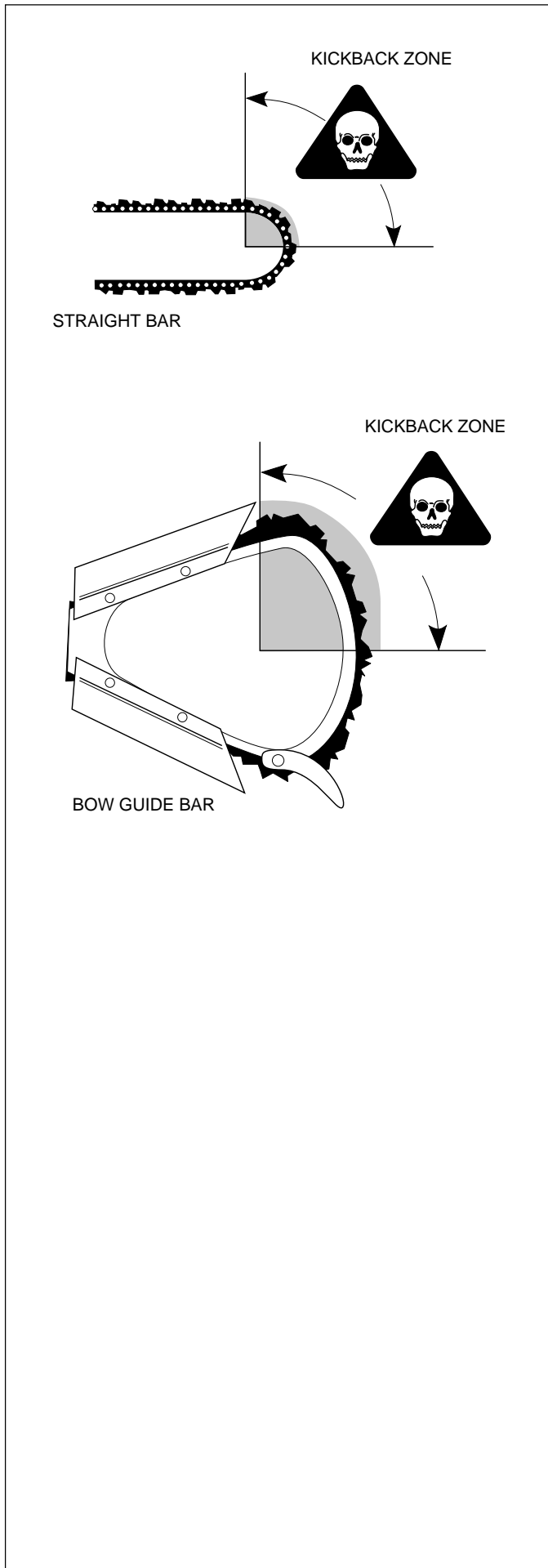

Bow Guide Bars

WARNING

Bow guide bars are capable of severe kickback. Only thoroughly instructed and experienced operators should use a chain saw equipped with a bow guide. Straight bars with significantly reduced kickback potential are available.

Bow guide bars are among the many accessories sold by retailers for use with the chain saws. Bow guide bars are mainly sold and used in the USA. The illustration shows the pear-like shape of a bow guide bar. A bow guide has an open center and a large nose radius. Compare the kickback danger zone of the bow guide bar with the kickback danger zone of a straight guide bar. The kickback danger zone on the bow guide bar is much larger than on a straight guide bar.

Improperly used, bow guide bars can produce a more severe kickback than a straight guide bar. Do not use a chain saw with a bow guide unless you have extraordinary cutting needs, experience, and specialized training in dealing with kickback.

The special "**Operator's Manual - Bow Guides**" is available for bow guide bar users. If your special needs require the use of a bow guide bar, you must follow all instructions in that Manual. Failure to follow instructions could result in serious or fatal injury. Guide bars with significantly reduced kickback potential are available.

CHAIN SAW SAFETY FEATURES

Saw Chains

Saw Chains Design

Saw chains are available in many different designs. The low kickback tendencies that are built into your saw chain also somewhat reduce its cutting potential. However, modern saw chain designs have both good cutting capacities and low kickback tendencies, and the benefit of better kickback protection is worth a small reduction in cutting performance. Below are four different types of saw chains and the features that reduce their kickback tendencies.

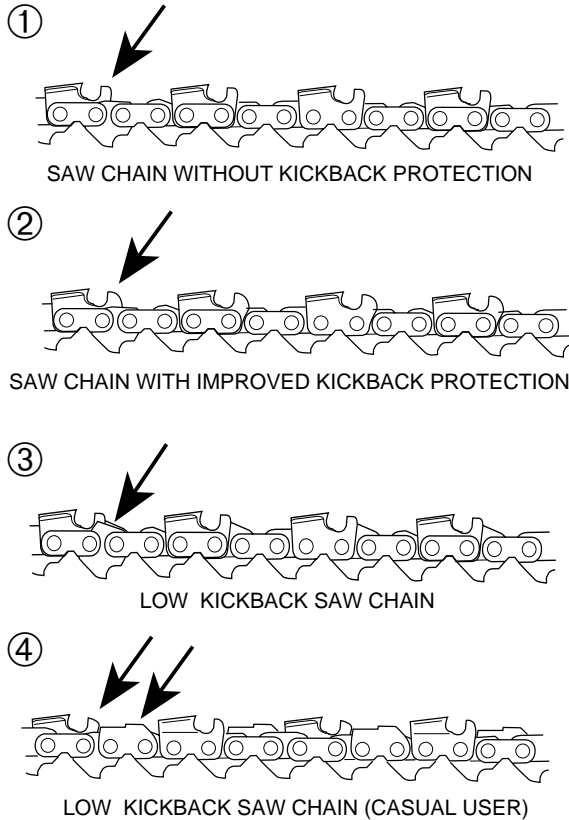

① **Saw chain without any kickback protection. Is not recommended.**

② **Saw chain with improved kickback protection.** Used by professional loggers. Do not use this type of saw chain unless you have specialized training for dealing with kickback. Saw chains with more reduced kickback potential are available.

③ **Low kickback saw chain.** Recommended for all kinds of cutting for the occasional operator.

④ **Low kickback saw chain.** Offers the best kickback protection. Mostly used on chain saws intended for casual operators due to its ability to reduce kickback.

CAUTION

No saw chain design **eliminates** the danger of kickback.

IMPORTANT

The designs shown above are from one manufacturer. Other manufacturers have accomplished similar results, but through other design features. The illustrations are intended only to show the appearances of some different designs.

Always use the saw chain that offers the best kickback protection for your use. Follow the recommendation in your Operator's Manual.

POTENTIAL DANGERS



Severe Laceration

Touching Chain

Taking the following steps will help to lessen the risk of touching the chain:

- Avoid cutting when tired; you have a greater chance of losing control of the saw.
- Set up work area to reduce chance of slipping or tripping.
- In demanding work situations (during felling, for example) plan your route of escape before you begin cutting.
- Shut off the saw when possible.
- Carry your chain saw safely with the chain to the rear (see page 28).
- Hold the saw firmly with both hands when the engine is running.
- Wear protective equipment (as described on page 7).
- Do not allow other people or animals in your work area.
- Activate the chain brake when starting the saw and when moving between work areas.

POTENTIAL DANGERS

What is Kickback?

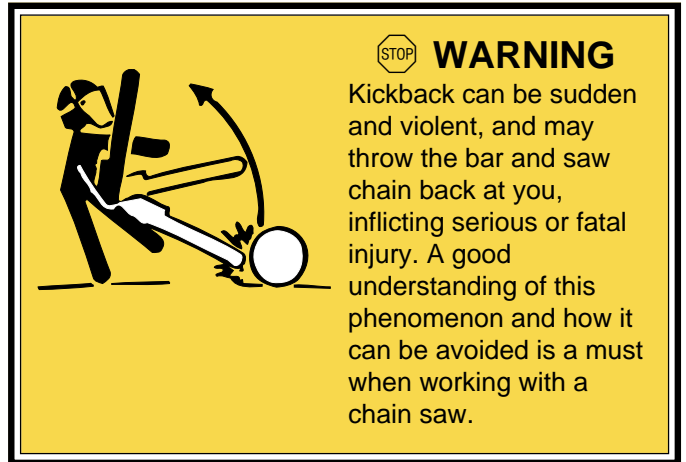
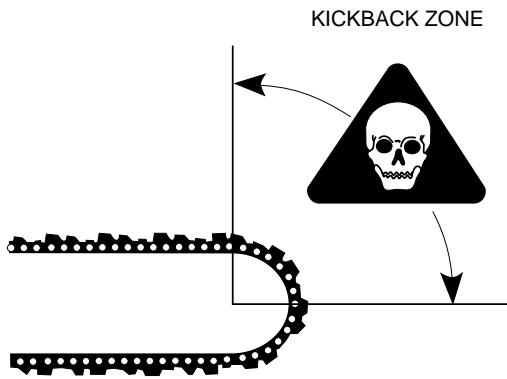

Kickback is the sudden, rearward motion of the saw that can occur if the kickback zone of the bar touches an object. Most kickbacks are small. They can cause the bar tip to jump only a few inches and pose little danger. However, a kickback can also be very powerful. If you are not paying attention and/or have a poor grip, the saw can be thrown all the way back at you. **If the chain is still running, and it hits you, it will severely cut you.**

Rotational Kickback

Kickback can occur when the upper tip of the guide bar, the **kickback zone**, touches something, such as a trunk, branch or other object.

When the nose is used, only one or two cutters engage the wood at a given time. As a result, the chain might grab or jam. When the chain gets blocked and stops, the reaction will cause the guide bar to kick back. It can be a lightning fast, reverse action, kicking the guide bar back at you.

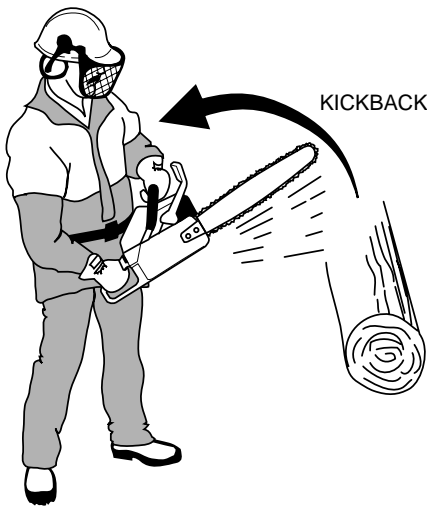

POTENTIAL DANGERS

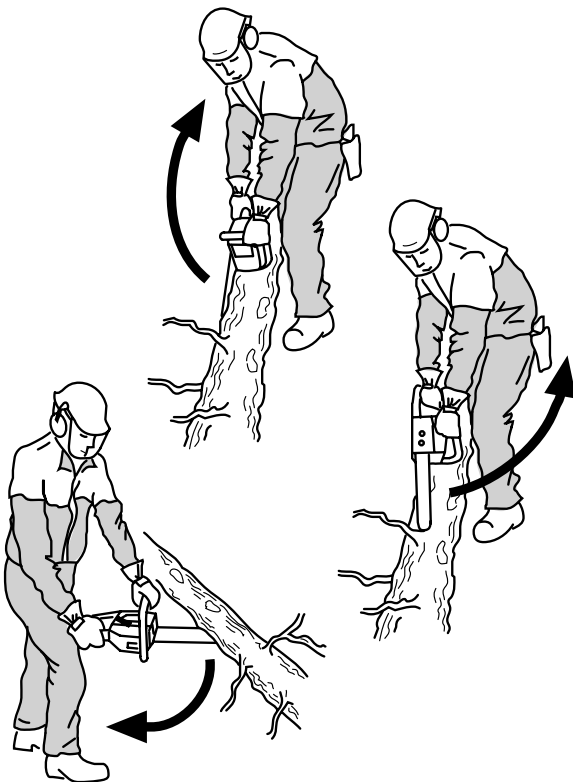
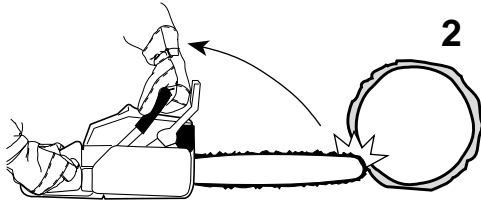
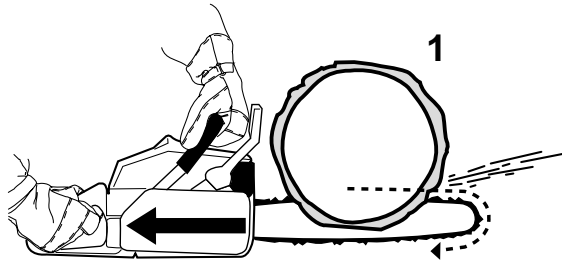

Pinch Kickback

1. Pinching the saw chain along the top of the guide bar may push the saw back at you.
2. If the bar is pushed back far enough so that the kickback zone hits an object, a rotational kickback may develop.

Direction of Kickback

A kickback always travels in the plane of the bar. Depending on how you hold the chain saw, a kickback may come up and back at you, or move in any angle you happened to hold the chain saw in. For example, if you experience a kickback during felling, the chain saw will move in the horizontal plane and can swing around and hit your leg.

IMPORTANT

- Kickback can only occur if the kickback danger zone of the bar touches an object.
- A kickback can be lightning fast.
- Although most kickbacks are small, sometimes a kickback can be very violent.

POTENTIAL DANGERS

Avoiding Kickback

Following the rules listed below will help to avoid kickback:

- Use proper working techniques.
- Do not use the kickback danger zone of the bar.
- Use proper grip.
- Avoid unsafe and off-balance working positions.
- Cut at high speed.
- Keep work piece secure.
- Make sure working area is free of obstructions.
- Be alert.

Proper Working Technique

The only sure way to avoid kickback and other dangers associated with chain saws is through proper working technique.

Avoid These Situations

Do not use the kickback danger zone when cutting. **As kickback can only occur when the kickback danger zone on the tip of the bar touches an object, kickback can be completely avoided by not cutting with that part.** Make sure that the area in which you are working is free from obstructions. Do not let the nose of the guide bar inadvertently contact a log, branch, or other obstruction which could be hit while you are operating the saw.

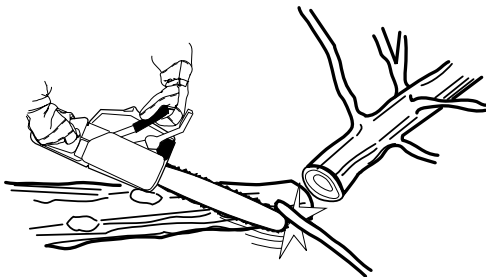
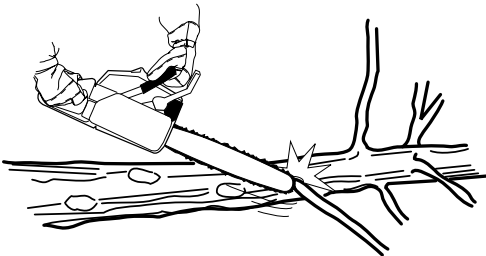
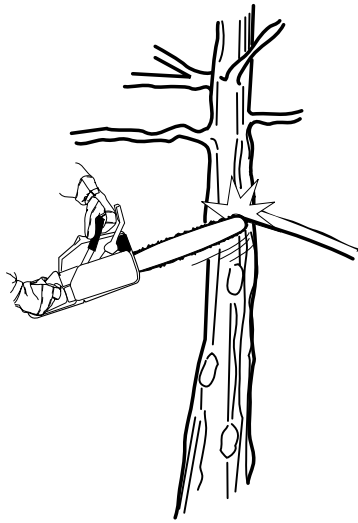

KICKBACK ZONE

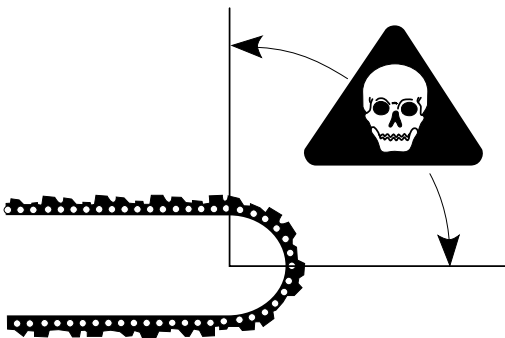

POTENTIAL DANGERS

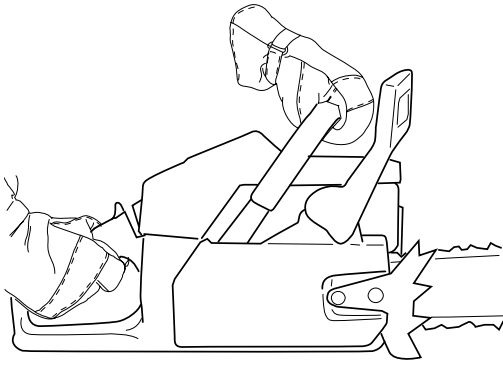

Use Proper Grip

When the engine is running, keep a good, firm grip on the saw, **always with both hands**. The **right hand** should be on the **rear handle**, and the **left hand** on the **front handle**. All people, whether right or left handed, should use this grip. Use a firm grip with thumbs and fingers encircling the chain saw handles. **Never use your saw while holding it with only one hand**. A firm grip will help you reduce kickback and maintain control of the saw.



Avoid Unsafe Positions

Do not use your saw above shoulder height or use the saw in a nose-high position. The saw is harder to control in these positions, and with the bar closer to your face/upper body, even a small kickback may have enough speed and force to reach you. Also, your chain brake may not have enough time to slow down the saw chain if the kickback starts from an unsafe position close to your body, even if the brake is activated.

Do not overreach or work from an unsafe position, such as ladders, in a tree, or a pile of wood. In such situations, your footing is insecure, and you can easily cut yourself, either through a simple distraction or through a kickback because your control of the saw is insufficient.



Use Proper Speed

Cut at high engine speed. At higher speeds, the saw chain is less likely to become stuck.

Have Control Over Work Piece

If the pieces you cut are small and light, the saw chain can catch and throw them at you. Although not necessarily dangerous in itself, you can be startled and lose control of the saw. Never cut logs or branches that are stacked without first pulling them apart. Cut only one log or piece at a time. Remove the pieces you have cut to keep your work area clear.

POTENTIAL DANGERS

Avoiding Kickback - Your Equipment

IMPORTANT

This equipment is for extra protection. It cannot fully prevent kickback, only minimize it. Never rely entirely on these safety devices for your protection. Rely on your safe working technique.

As explained previously, kickback can be avoided by using safe cutting techniques, where at all times you avoid cutting with the tip of the bar. However, certain items on your chain saw are also designed to minimize the kickback itself or possible injuries should you encounter a kickback.

Low Kickback Saw Chains

Modern saw chains are designed to reduce the force of kickback. Your Operator's Manual lists low kickback saw chains that have been tested and selected for your saw.

CAUTION

The saw chain can give its intended protection only if it is filed and maintained according to the manufacturer's instructions. As the cutting tooth on a saw chain is filed away when it is sharpened, it slowly becomes more aggressive. At the end of its life, it is more kickback prone than when it is new.

Your saw chain has been designed to reduce the possibility of kickback. If the chain is not filed according to the manufacturer's directions, you may remove some of the saw chain's kickback features. Such a chain is more dangerous to use. Always follow the saw chain manufacturer's filing instructions.

When your saw chain has to be replaced, you should replace it with a low kickback chain. Follow our recommendation in the Operator's Manual, or your dealer's advice. Be sure that you get a chain which will give you the same or better protection as the original equipment.

Small Nose Radius Bar

The smaller the nose radius, the smaller the kickback zone, and the less likely a severe kickback will occur. Your Operator's Manual specifies small nose radius bars available for your saw.

IMPORTANT!

To minimize the risks of kickback through your bar and chain combination, you should always:

- Use small nose radius bar and low kickback saw chain.
- Check and adjust saw chain tension.
- Maintain the correct depth gauge and sharpness of the chain.
- Replace worn-out or damaged bar and chain with approved replacement combinations.

Nose Guard

A metal nose guard is attached to the bar tip covering the kickback danger zone while allowing the chain to rotate under it.

With a properly installed nose guard, a kickback cannot occur. However, a nose guard also limits the use of your saw.

When using a nose guard, the bar has to be more than 2 inches longer than the thickest log you intend to cut, making certain felling and bucking techniques impossible. Due to this drawback and others, we do not manufacture or market nose guards. If you feel that a nose guard will offer the best protection for you, your dealer will be able to assist you in installing one.

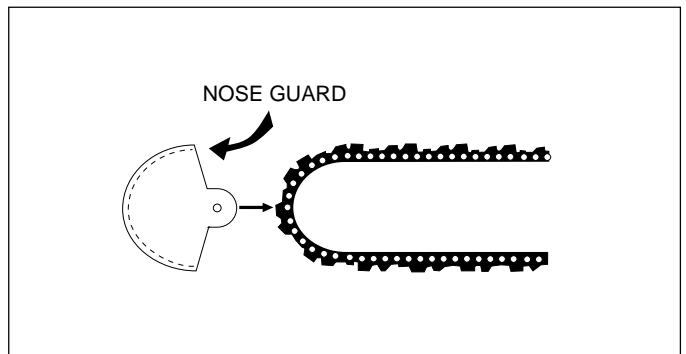

POTENTIAL DANGERS

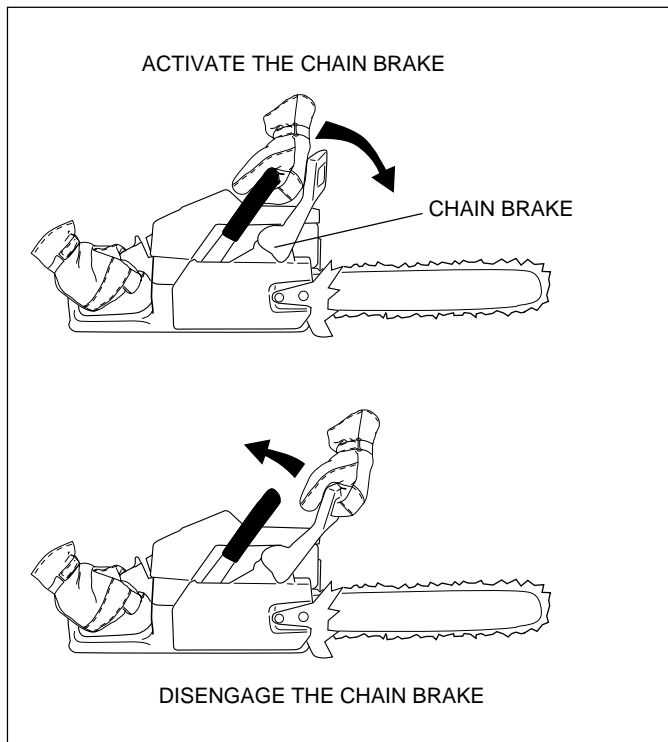

⚠ CAUTION!

A chain brake may not always activate during a kickback. A chain brake can give you its intended protection only if it is properly maintained. A neglected and abused chain brake might not work when you need it most. Test the chain brake periodically to be sure it will work for you if you have a kickback. We recommend that you test the chain brake after each work break. If the chain brake does not activate, clean it and check that the mechanism is not damaged. If the chain brake still does not work, take your chain saw to your servicing dealer for repair.

Please refer to your Operator's Manual for proper testing procedure of the chain brake on your saw.

IMPORTANT!

Kickback and its possible consequences can be avoided.

- Use proper working techniques.
- Do not use the kickback danger zone of the bar
- Avoid unsafe positions.
- Use proper grip.
- Cut at high speed.
- Have control over your work piece.
- Be alert.

Chain Brake

One safety feature of the chain saw is the chain brake. It will not prevent a kickback, but is designed to stop the saw chain. When the chain brake is triggered, a mechanism which locks the clutch drum is activated and stops the saw chain almost instantly. The mechanism can be reset by moving the hand guard back against the front handle.

The chain brake is designed to activate when the front hand guard is moved forward. This can be done in two ways. **Manually** or by **Inertia**.

You can **manually** move the front hand guard forward with your left hand and activate the chain brake. This may be done intentionally when you need to activate the chain brake. It can also occur if your left hand slips off the front handle and moves the front hand guard forward.

The forces of a kickback can also activate the chain brake without your hand touching the front hand guard. This is called **inertia** activation.

Will My Hand Always Activate the Chain Brake During a Kickback?

No. It takes a certain force to move the hand guard forward. If your hand only lightly touches the front guard or slips over it, the force may not be enough to trigger the chain brake. You should also maintain a firm grip of the chain saw handles while working. If you do and experience a kickback, your hand may never leave the front handle and will not activate the chain brake, or the chain brake will only activate after the saw has swung around a considerable distance. In such instances, the chain brake might not have enough time to stop the saw chain before it touches you.

There are also certain positions in which your hand cannot reach the front hand guard to activate the chain brake; for example, when the saw chain is held in felling position.

Will My Inertia Activated Chain Brake Always Activate During Kickback in the Event of a Kickback?

No. First your brake must be in working order. Testing the brake is simple. We recommend you do before you begin each work pass. Second the kickback must be strong enough to activate the chain brake. If the chain brake is too sensitive it would activate all the time which would be a nuisance.

Will My Chain Brake Always Protect Me from Injury in the Event of a Kickback?

No. First, the chain brake must be in working order to provide the intended protection. Second, it must be activated during the kickback as described above to stop the saw chain. Third, the chain brake may be activated but *if the bar is too close to you* the brake might not have enough time to slow down and stop the chain before the chain saw hits you.

Only you and proper working technique can eliminate kickback and its danger.

POTENTIAL DANGERS

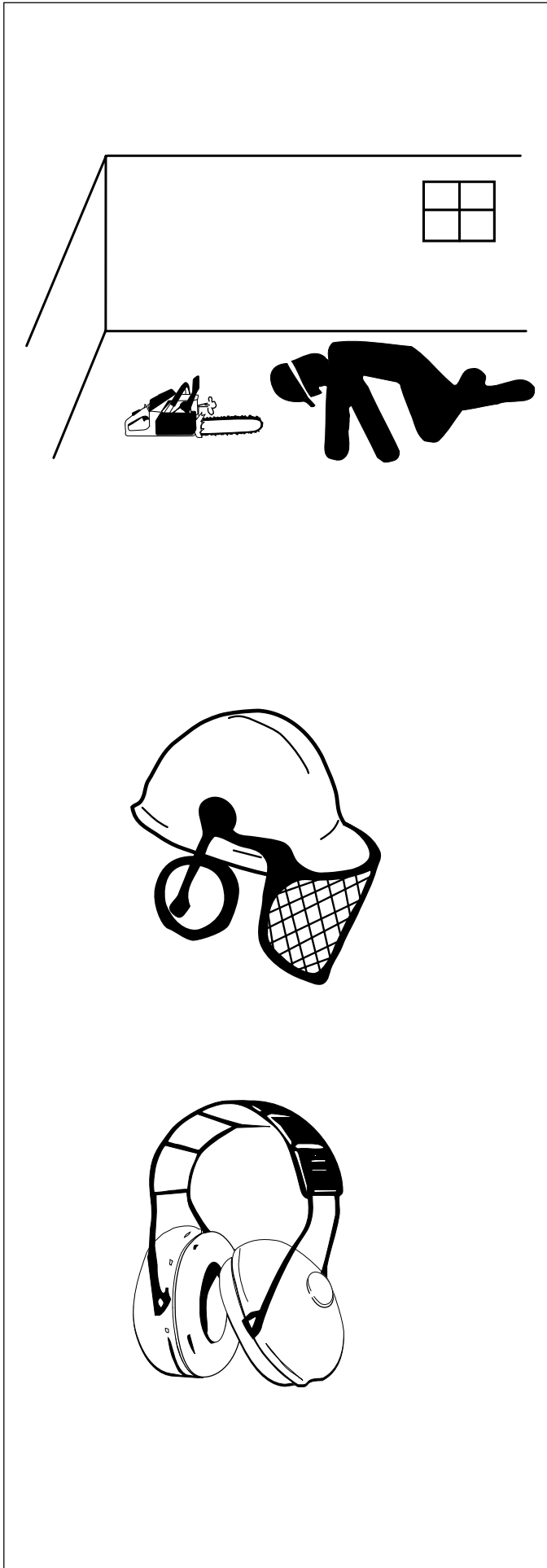

Carbon Monoxide Poisoning

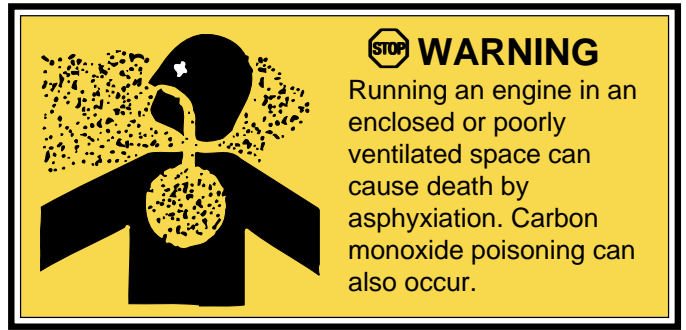

STOP WARNING
Running an engine in an enclosed or poorly ventilated space can cause death by asphyxiation. Carbon monoxide poisoning can also occur.

Carbon monoxide is a colorless, odorless, tasteless byproduct of an internal combustion engine, and is always present in exhaust fumes.

The onset of carbon monoxide poisoning is distinguished by a slight dizziness which may or may not be recognized by the victim. A person may collapse and lapse into unconsciousness with no warning if the concentration of carbon monoxide is sufficiently high. Symptoms of mild intoxication are vague and non-specific, including mild headache, general weakness and fatigue.

Since carbon monoxide is colorless and odorless, its presence cannot always be detected. Any time exhaust odors are noticed, carbon monoxide is present.

Never use your gasoline powered chain saw indoors, in a trench, or other confined area with poor ventilation where the exhaust fumes are not ventilated away.

Hearing Loss

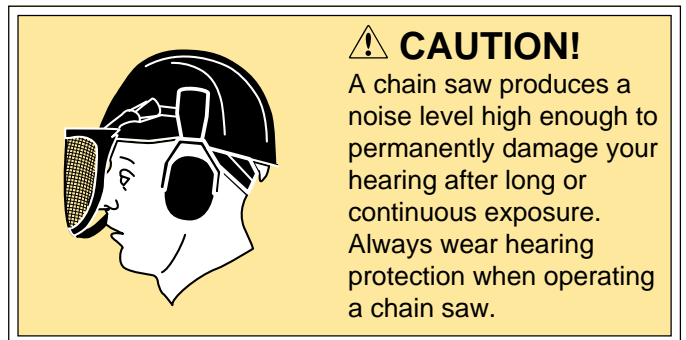

CAUTION!
A chain saw produces a noise level high enough to permanently damage your hearing after long or continuous exposure. Always wear hearing protection when operating a chain saw.

Long or continuous exposure to high noise levels may cause permanent hearing impairment. A normally muffled chain saw engine produces enough noise to damage your hearing. You must always wear hearing protectors when using your chain saw.

IMPORTANT!

The earmuffs are designed to reduce the risk of hearing injuries. As they shield you from the noise of the chain saw, they may also block other sounds as the sound of a tree breaking or shouts from fellow workers. Therefore, you must also stay visually alert all the times.

POTENTIAL DANGERS

CAUTION!

If you experience any discomfort in your fingers, hands, wrists or arms, you should discontinue any work with ALL VIBRATING TOOLS. See your doctor for medical advice.

Vibration Injury

Prolonged use of vibrating hand tools, such as chain saws, can cause blood vessel or nerve damage in the fingers, hands, and wrists of some people prone to circulation disorders or abnormal swelling. Among the conditions that may be associated with blood vessel and nerve damage are Raynaud's Syndrome (white finger disease) and carpal tunnel syndrome.

If symptoms occur, such as numbness, loss of feeling, tingling, pain, loss of strength, change in skin color or texture, or any other abnormal sensation or feeling in the fingers, hands, or wrists, discontinue use of the chain saw and seek medical attention. Before using this or any other vibrating hand tool, you should consult with your physician to determine the possible effects of vibration on you.

Long exposure to vibration also adds to operator fatigue which can, in turn, adversely affect an operator's ability to safely direct and control the saw. If you feel fatigued or weak, discontinue use of the saw immediately.

To minimize the risk of vibration-related conditions, your chain saw has been engineered to reduce the operator's exposure to harmful vibration levels. The rubber isolators or vibration damper blocks between the powerhead and handle unit are part of engineering efforts to reduce vibration. These rubber isolators should be checked and replaced when necessary as use of the saw, exposure to the elements, and exposure to gasoline and oils minimize their effectiveness over time.

All people who operate chain saws for any extended length of time should take the following precautions:

- Use a saw with low vibration characteristics.
- Keep your body and hands warm. Some saw models have heated handles which will keep your hands comfortable even in cold weather.
- Wear gloves.
- Refrain from smoking.
- Limit your vibration exposure per day or season. Take frequent work breaks.
- Keep the saw chain sharp and the saw well maintained. A dull chain will increase the cutting time. If you increase the pressure of your hands on the handle to press a dull chain through the wood, you will increase the vibration transmitted to your hands. A saw with loose components will also increase vibration.
- Keep the anti-vibration elements in good condition and replace them when necessary.

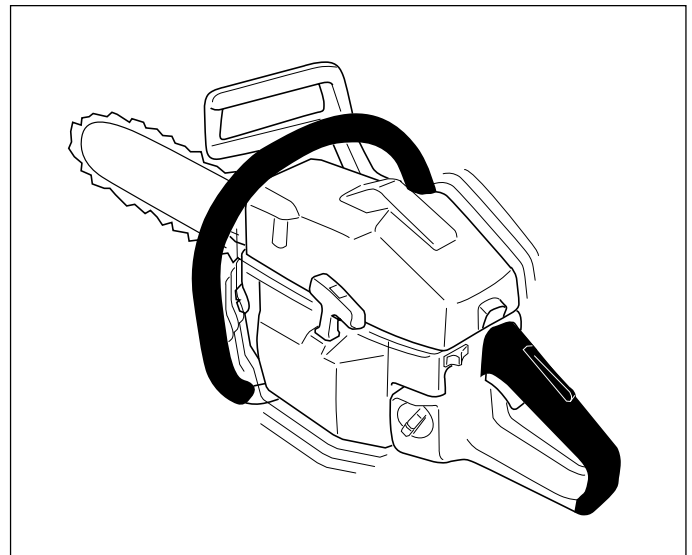

POTENTIAL DANGERS

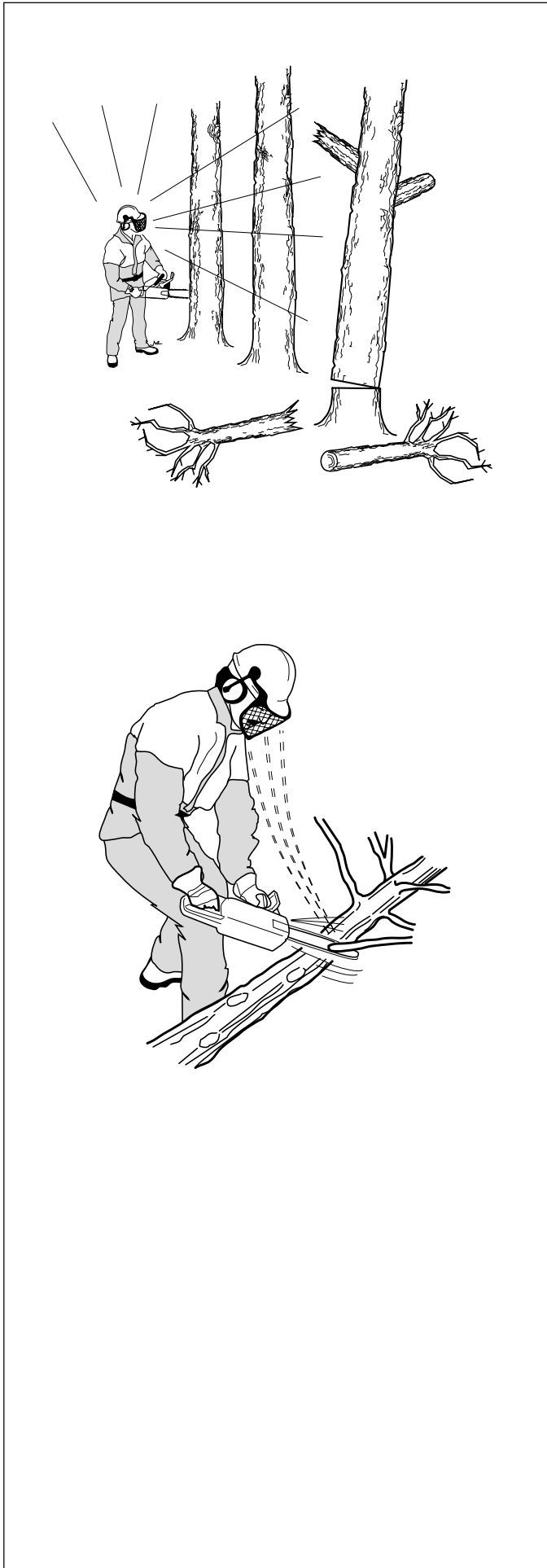

Crushing, Fracture or Puncture

Falling Timber



Falling timber can cause serious or fatal injury. Before cutting, look for:

1. Broken or dead branches.
2. Surrounding trees. When your tree falls, will it cause other trees or branches to be broken off.

Thrown Objects

When the engine is running at cutting speed, the saw chain rotates at about 40-50 mph (20 m/s). It is capable of throwing objects, such as sawdust, small pieces of wood, etc., with great force, and can cause serious injury, especially to the eyes.

The mesh in the face shield many logging helmets are equipped with, is intended to protect your face from branches, twigs and saw dust generated during cutting. It is not strong enough to protect your eyes from sharp particles that may be thrown at you. Therefore, we also recommend you wear protective goggles.



POTENTIAL DANGERS

Burns, Fire

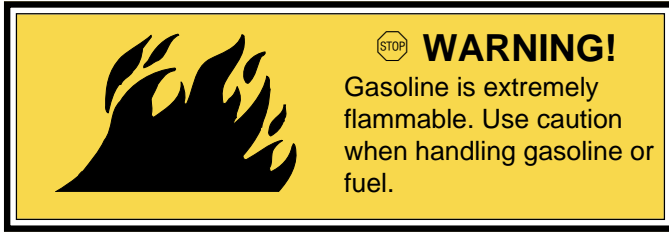

Taking the following precautions will lessen the chance of fire:

- Check your saw for fuel leakage periodically: fuel tank, cap, hose, etc. Repair as soon as any parts seem to be in poor condition or as soon as a leakage is noticed.
- Fill the chain saw fuel tank in well-ventilated areas on a bare surface at least 10 feet (3 m) away from the cutting area.
- Be sure the muffler is undamaged and securely fastened.
- Keep the spark plug cover and ignition wire in good condition. Replace if worn or damaged.
- Do not smoke or allow any source of heat near gasoline or fuel.
- Allow a hot saw to cool before refueling.
- When refueling, open fuel cap slowly to release any pressure.
- If fuel is spilled on the engine, wipe it off or let it evaporate before starting the saw.
- Clear flammable material away before cutting and do not leave a hot saw on dry litter or combustible material.
- Do not use a saw that is backfiring or otherwise not running properly. Have it repaired.
- Keep a fire extinguisher and shovel handy.
- Do not use a damaged muffler or a muffler without a spark arrestor screen if required in your area.

Touching a hot muffler causes burns. A hot muffler or hot exhaust gases can start a fire in combustible material. Spills or improper handling of fuel or gasoline can cause fire or explosion.

Some states in the USA require testing and approval of muffler design and exhaust gas temperatures. Do not modify your muffler, as it may be unlawful to operate a modified saw and you might start a forest fire. Help prevent wildfires.

Fuel Spillage



Fuel spillage may occur because of fuel tank over-filling. If fuel spillage has occurred, do not attempt to start your chain saw. The excessive fuel may catch fire. The fuel may be ignited by sparks from many sources such as the muffler, defective wiring, the bar and chain etc. Tilt the saw over in both directions to allow spilled fuel to run off. Remove the cylinder cover. Remove any build-up of saw dust. If such build-up has been soaked in fuel, it will take much longer for the fuel to evaporate. Let saw sit for at least 15 minutes to allow the fuel to evaporate; longer if the temperature is below 50°F (10°C). Move the saw at least 10 feet (3 m) away from the spot where you refueled the saw to avoid that any remaining fuel on the ground catches fire.

BEFORE STARTING/AFTER STARTING

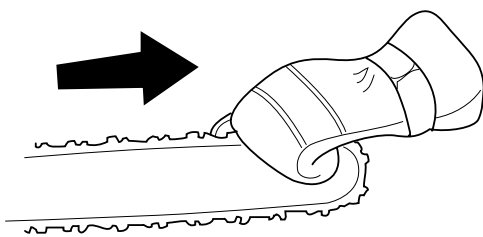
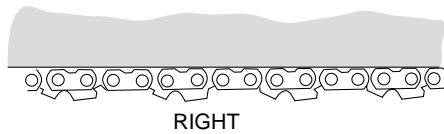
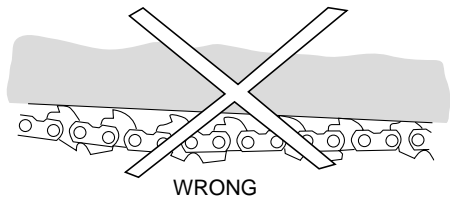

WARNING!

To prevent serious injury, do not use a saw that is damaged or in poor condition.

WARNING!

Failure to test and maintain the chain brake according to the Operator's Manual may result in the chain brake failing to operate in the event of kickback.

Safety Check - Before Each Use

Adjust Saw Chain Tension

CAUTION!

Always shut off the engine before adjusting the chain tension.

Never do any maintenance on the saw chain with the engine running.

Wear gloves to avoid getting cut.

A loose saw chain can jump off the guide bar and cause serious injury or death. A loose chain is also the main reason for excessive wear and damage to the bar and chain. Bar and chain installation is explained in the Maintenance Section of your Operator's Manual.

A properly adjusted chain is tight, but you should always be able to turn the chain freely with a gloved hand. Allow the bar to cool before adjustment. Check after tensioning by pulling the chain in the normal direction of rotation.

Lubricate Saw Chain

Fill chain oil tank with oil each time you refuel. Operating saw chain while oil tank is empty will cause damage to guide bar and saw chain. Use oil that is designed for saw chains. Check your Operator's Manual for more information.

BEFORE STARTING/AFTER STARTING

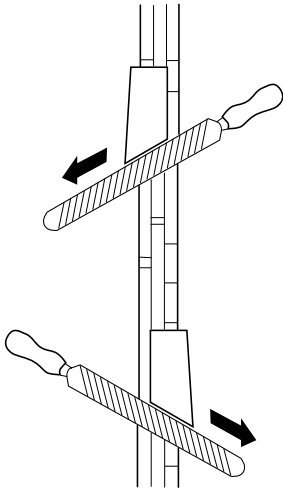

Keep Saw Chain Sharp

Always keep the saw chain sharp. A damaged, dull or incorrectly filed chain increases vibration and pressure on your hands and takes longer to saw through the wood. Follow saw chain manufacturer's recommendation when sharpening saw chain, or have your saw chain sharpened by your chain saw dealer.

WARNING!

File and maintain saw chain according to manufacturer's instruction. A misfiled saw chain may increase the chains propensity for kickback. Kickback could lead to serious injury or death.

Maintain Saw Chain

WARNING!

Worn or damaged saw chain or guide bar may break and cause serious injury or death. Replace entire saw chain if it is damaged or broken.

Keep chain properly sharpened, lubricated and correctly tensioned. Chain breakage is almost always the result of poor maintenance.

Inspect rivets and links on saw chain for cracks and other defects before using. Do not use a damaged saw chain. Always use a filing gauge to achieve correct setting when filing depth gauges. Depth gauges set too low increase strain and the risk of chain breakage. A depth gauge that is too low increases potential for kickback and eliminates the design protection built into the product. Replace worn saw chains. Refer to your Operator's Manual and saw chain manufacturer's manual for proper maintenance and for information regarding when the saw chain should be replaced.

BEFORE STARTING/AFTER STARTING

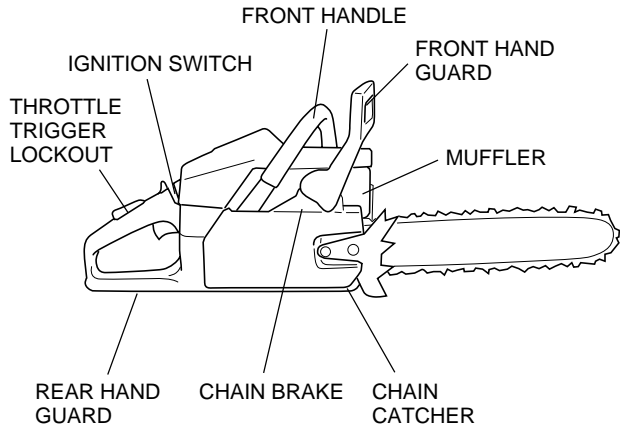

Before Each Use

1. Be sure chain brake is operating properly and undamaged.

Note: Your Operator's Manual gives instructions on how to properly test the chain brake.
2. Check rear-hand guard for damage.
3. Be sure chain catcher is in place and undamaged.
4. Be sure throttle trigger lockout is operating properly and undamaged.
5. Be sure ignition switch is operating properly and undamaged.
6. Be sure anti-vibration components are in place and undamaged.
7. Be sure muffler is in place and undamaged.
8. Be sure all handles are clean and free from oil.
9. Check entire saw for loose fasteners and damaged or missing components.

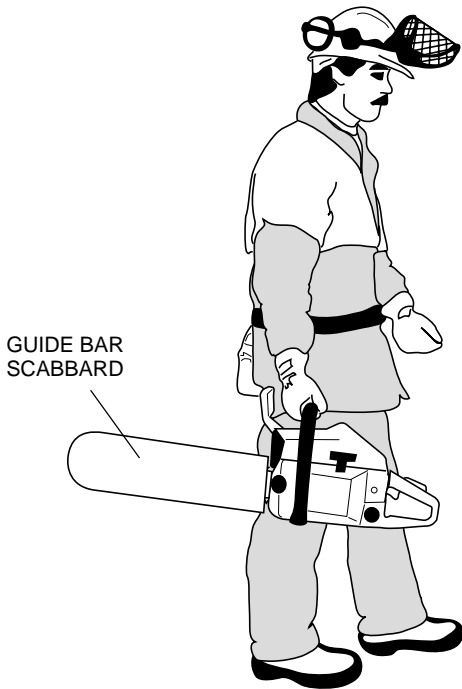

Carrying The Saw

1. Always turn off the engine before walking with the saw.
2. Do not leave the saw unattended while the engine is running.
3. Install guide bar scabbard on guide bar before carrying saw.
4. Carry the saw with the bar pointing to the rear and with the muffler away from you.
5. Engage the chain brake when mowing between work areas.

BEFORE STARTING/AFTER STARTING

Starting The Saw

IMPORTANT!

See starting section of the Technical Manual for details of how to set the choke, throttle latch, etc.

STOP WARNING!

Your chain saw is a one-person saw. Start and operate your saw without assistance, and do not allow other people or animals to come near you while operating the saw.

1. The chain brake should be activated when starting the chain saw. Activate the chain brake by pushing the front hand guard forwards.
2. Place the saw on firm, level ground, and be sure the chain is clear of all obstructions before starting the engine.
3. Slide stop switch to "ON" position.
4. Place your right foot in the rear handle. Grip the front handle firmly with your left hand.
5. Pull out starter cord slowly until the starter mechanism is engaged. Never wrap the starter cord around your hand.

STOP WARNING!

Chain will rotate after starting with throttle latch engaged if the chain brake is not activated.

6. Apply a short, sharp pull to the starter rope, repeat until engine starts.

IMPORTANT!

Hold the starter handle as the rope retracts. If you allow the starter rope to pull in by itself the fast action may damage the starter

7. Immediately press and release the throttle when the engine starts. That will disengage the throttle latch. As the chain brake is still activated the engine must return to idling speed as soon as possible by disengaging the throttle latch in order to avoid unnecessary wear on the clutch assembly.
8. Pull the front hand guard towards the front handle. The chain brake is now disengaged. Your saw is now ready for use.

STOP WARNING!

A – Do not drop start. This method is very dangerous because you may lose control of the saw.

STOP WARNING!

B – Do not start your saw without the bar, chain and clutch cover mounted. If you do, the clutch can come loose and cause severe personal injury.

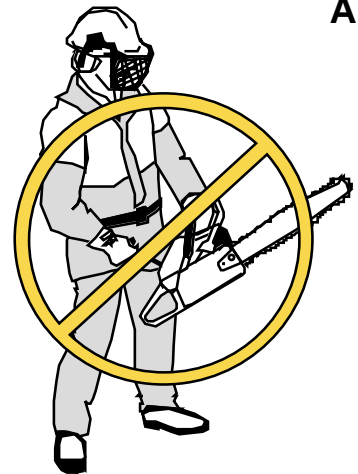

BEFORE STARTING/AFTER STARTING

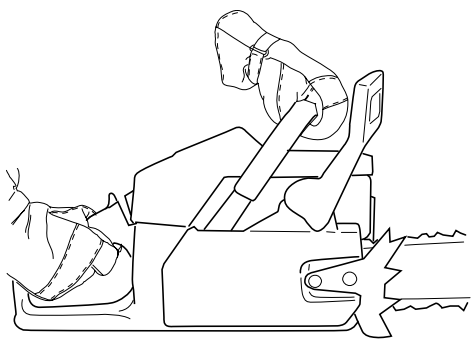

Holding The Saw

With both hands, keep a good, firm grip on the saw. The right hand should be on the rear handle, and the left hand on the front handle. Use a firm grip with thumbs and fingers encircling the chain saw handles. A firm grip will help you avoid kickback and maintain control of the saw.

If You Are Left Handed

Your chain saw is designed for a grip with your right hand on the rear handle and left hand on the front handle. **ALL PEOPLE, WHETHER RIGHT OR LEFT HANDED, SHOULD USE THIS GRIP.** Using the opposite grip, right hand - front handle, left hand - rear handle, gives you less control of the saw. It also brings the bar and chain closer to your body during normal operation. It is also possible you will not be able to activate the chainbrake if your **right hand is** holding the front handle.



WARNING!

Never operate a chain saw holding it with one hand only. As the chain saw is not properly controlled, you can cut yourself. Always maintain a firm, solid grip with both hands on the handles.

Never Hold a Chain Saw with Only One Hand While Working.

Holding the saw with one hand when working is dangerous. The saw cannot be properly controlled. As you have less control of the saw, it has a tendency to bounce and skate when you start cutting. Under those circumstances, the saw may cut you. Because of your lack of control, you are also more likely to get a kickback. In the event of a kickback, a manual chain brake cannot be activated.

After Starting The Saw

1. Be sure the throttle trigger moves freely. When you release the throttle trigger, the engine speed must drop and return to idle by itself. The saw chain must not move when the engine is idling. If the saw chain continues to move at idle speed, the carburetor must be adjusted (see carburetor section of accompanying Operator's Manual) or the saw returned to the dealer for proper adjustment. (Note: if the saw has a broken clutch spring, carburetor adjustment will not stop the chain from moving).
2. Test the chain brake. Refer to your Operator's Manual for the proper testing procedure of the chain brake.
3. Be sure the stop switch stops the engine.
4. After using the saw for 10-15 minutes, turn off the chain saw and check the chain tension.

Stopping The Saw

1. Using right thumb, slide the stop switch to the "STOP" position.

BASIC WORKING TECHNIQUES

IMPORTANT!

This information does not cover all specific situations. They may depend on differences in terrain, vegetation, type of wood, form and size of trees, etc. Consult your servicing dealer, forestry agent or local forestry schools for advice on specific woodcutting problems in your area.

This will make you more efficient and your work safer.

General Rules

1. Avoid cutting in adverse weather conditions, such as dense fog, heavy rain, bitter cold, high winds, etc.

Adverse weather is often tiring to work in and creates potentially dangerous conditions such as slippery ground. High winds may force the tree to fall in an unexpected direction causing proper damage or personal injury.

2. Avoid stumbling on obstacles, such as stumps, roots, rocks, branches and fallen trees.
3. Watch out for holes and ditches.
4. Be extremely cautious when working on slopes or uneven ground.
5. Turn saw off before moving from one place to another.
6. If you are not completely sure a cutting situation is safe, or you require assistance, get help before continuing.

Reactive Forces

When you are cutting, the chain in the kerf forces your saw in a direction opposite to the chain movement. This is called a reactive force. One such reactive force previously covered is kickback. With any chain saw, the energy used to cut wood can be reversed and work against the operator. If a rotating chain stops suddenly because the chain is pinched or if the chain suddenly hits a solid object, reactive forces occur instantly and may make you lose control of the saw.

1. Be especially alert during limbing operations when it is easier to pinch the chain or to touch a limb by mistake.
2. Keep your feet firmly planted, in a wide, balanced stance.
3. Keep the saw body close to your body to improve control and to reduce strain.
4. When cutting with the bottom part of the chain (pulling chain), the reactive force will pull the saw away from you towards the wood you are cutting. The sawdust will be directed toward you.
5. When cutting with the upper part of the chain (pushing chain), the reactive force will push the saw toward you and away from the wood you are cutting.
6. Cut with the bottom part of the chain as much as possible.

REACTIVE FORCES

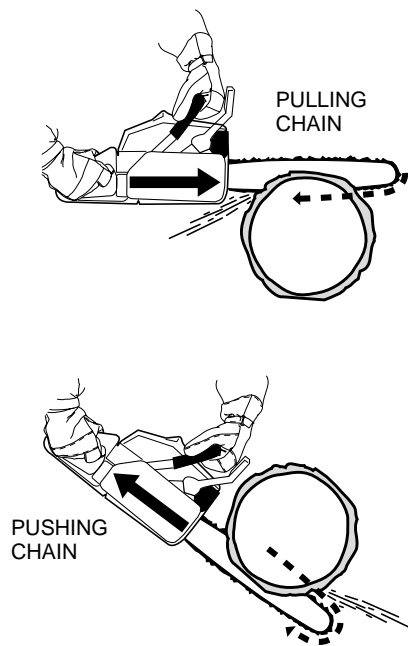

WARNING!

If you are cutting with a pushing chain and allow the saw to be pushed back far enough to touch the tip of the bar, a kickback may occur. See page 17. Be especially cautious regarding nearby objects when cutting with a pushing chain or "under up". The kickback zone will move INTO such objects during "under up" cutting, increasing the possibility of kickback.

BASIC WORKING TECHNIQUES

Boring Cut

A boring cut is used to fell large trees. Follow the steps listed below when performing a boring cut.

1. Cut, using the bottom portion of the guide bar tip, until the depth of the cut is equal to the width of the guide bar and deep enough to stop a kickback during steps 2 and 3.
2. Operating at full throttle, align the saw with the direction of cut.
3. With saw at full throttle, press the guide bar straight into the trunk.

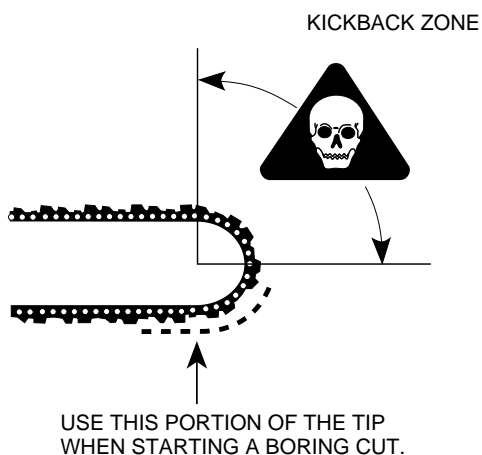
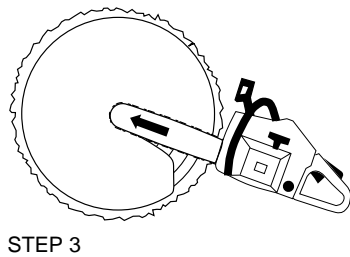
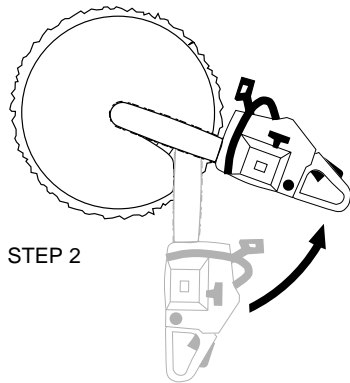
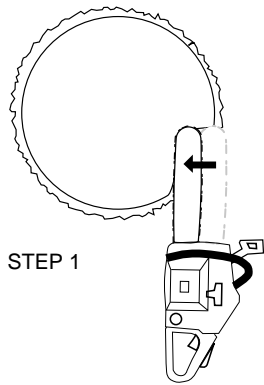

WARNING!

Making a boring cut can be dangerous if improperly performed. Only properly trained operators should attempt this technique.

BASIC WORKING TECHNIQUES

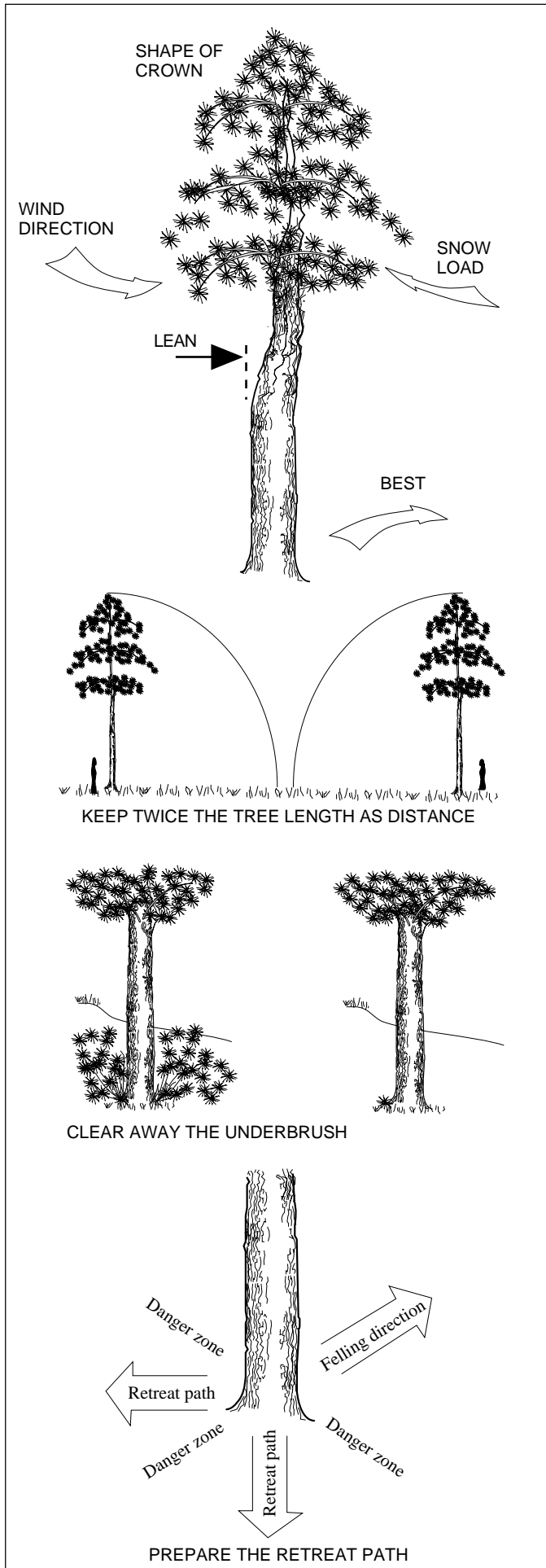

Felling

Felling is more than cutting down a tree. You must also bring it down as near to an intended place as possible without damaging the tree or anything else.

Before Felling

Carefully consider all conditions which may affect the intended direction of fall, including:

1. Inclination of tree.
2. Shape of crown.
3. Snow load on crown.
4. Wind direction.
5. Obstacles within tree range: e.g., other trees, power lines, roads, buildings, etc.

⚠ CAUTION!

Always observe the general condition of the tree. Look for decay and rot in the trunk, which will make it more likely to snap and start to fall before you expect it. Look for dry branches, which may break and hit you when you are working.

Always keep animals and people at least twice the tree length away while felling.

Clear away shrubs and branches from around the tree.

Prepare a path of retreat diagonally away from the felling direction.

BASIC WORKING TECHNIQUES

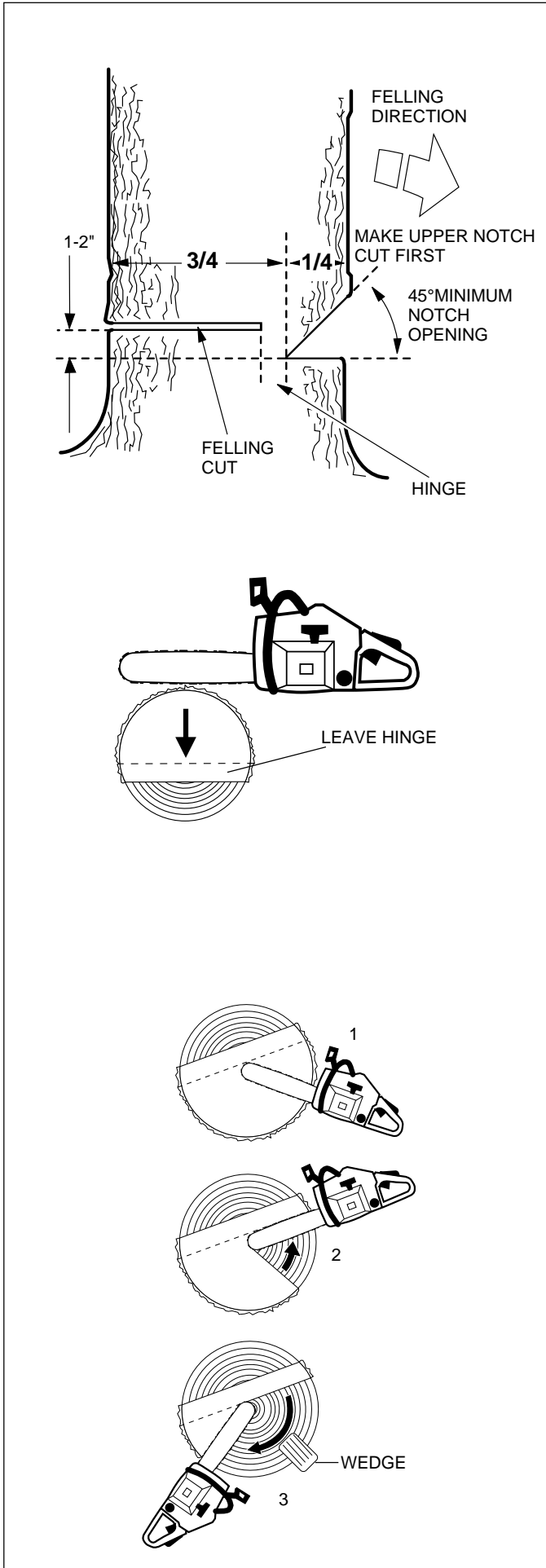

Basic Rules for Felling Trees

Normally, the felling consists of two main cutting operations - notching and making the felling cut.

1. Make the upper notch cut on the side of the tree facing the felling direction. Look through the kerf as you saw the lower cut so you do not saw too deeply into the trunk. The notch should be deep enough to create a hinge of sufficient width and strength. The notch opening should be wide enough to direct the fall of the tree as long as possible.
2. Saw the felling cut from the other side of the tree between one and two inches (3-5 cm) above the edge of the notch.
3. Never saw completely through the trunk. Always leave a hinge. The hinge guides the tree. If the trunk is completely cut through, you will lose control over the felling direction.
4. Insert a wedge or a felling lever in the cut well before the tree becomes unstable and starts to move (A). This will prevent the guide bar from binding in the felling cut if you have misjudged the falling direction. Be sure no people have come into the range of the falling tree before you push it over.

Felling Cut - Trunk Diameter Less than Guide Bar Length

Saw with a pulling chain (bottom of guide bar).

Felling Cut - Trunk Diameter Greater than Guide Bar Length

⚠ CAUTION!

Watch out for kickbacks. Do not use the upper tip quadrant of the guide bar tip.

1. Make a boring cut.
2. Saw with a pushing chain. Leave sufficient hinge.
3. Insert a wedge or a felling lever to prevent pinching. Saw around trunk with a pulling chain to complete felling cut.

BASIC WORKING TECHNIQUES

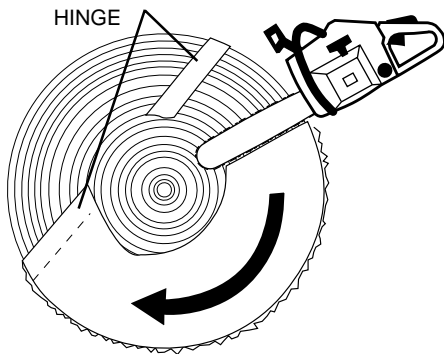
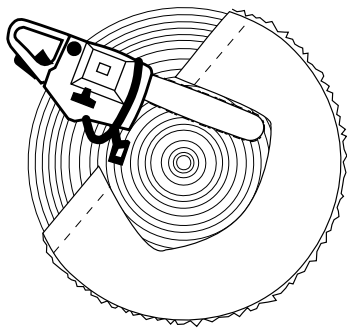

Felling Cut - Trunk Diameter More than Twice Guide Bar Length

1. Cut a large, wide notch.
2. Cut a recess into center of notch.

IMPORTANT!

Always leave a hinge on both sides of center cut.

3. Saw around trunk with a pulling chain to complete felling.

Do not forget to insert a wedge or felling lever.

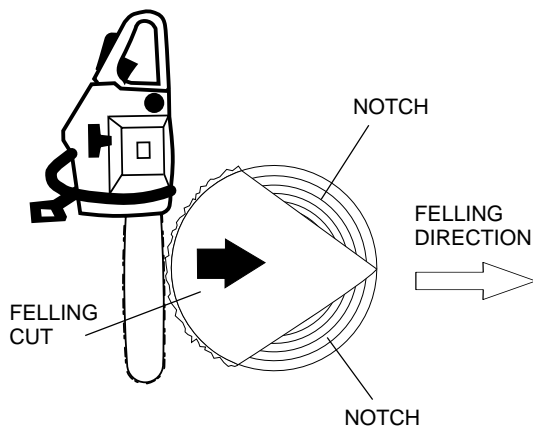

Felling Leaning Trees

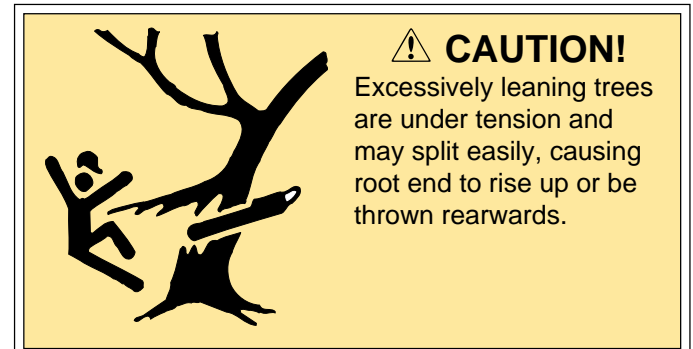

1. Make two notches. The tip formed where the notches meet should point toward the felling direction.
2. Make the felling cut straight from behind, a bit at a time.

This method will slow the fall of the tree and allow you to get clear.

BASIC WORKING TECHNIQUES



CORRECT



WRONG

Lodged Trees



WARNING!

A lodged tree is a dangerous situation. Do not try to fell a tree in which another tree is lodged.

Do not fell another tree onto a lodged tree.

Do not work inside the danger area of a lodged tree and do not allow people inside danger area.

Some Suggestions as to How You can Take Down a Lodged Tree

If the tree you have felled gets hung up, do nothing hastily. Take a rest and give some thought to the situation in peace and quiet. Consider various alternatives and always choose a safe method even if it takes a little longer.

Simple Hang-Ups Rolling the Tree

1. Determine direction tree can most easily be rolled down.
2. Cut tree loose from hinge, leaving a little on the side you intend it to roll down on.
3. Using a cant hook or similar tool, roll the tree away from you.
4. Lift with a straight back.



CAUTION!

If you are not properly positioned when the tree starts to move, you might get caught by the cant hook or the tree itself.

If the tree is wedged in another tree's branches, you can exert more rolling force using a cant hook and a long pole. Remember to lift correctly with a straight back.

BASIC WORKING TECHNIQUES

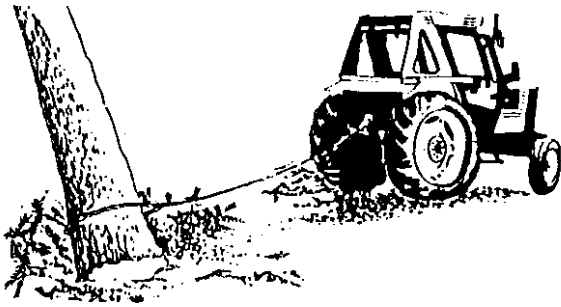

More Difficult Hang-Ups

Use a portable or tractor-mounted winch and pull the tree down.

CAUTION!

Do not abandon a leaning, hung or lodged tree. It must be taken down, or it can become a danger to other people. Mark off the area if you temporarily have to leave to get assistance.

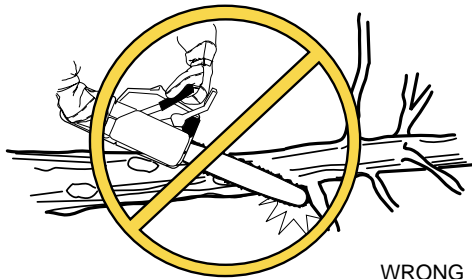

WRONG

Limbing

Limbing is removing the branches from a felled tree.

WARNING!

A majority of kickback accidents occur during limbing. Do not use the kickback zone of the guide bar. Be extremely cautious and avoid contacting the log, other limbs or objects with the nose of the guide bar. Be extremely cautious of limbs under tension. They can spring back toward you and cause loss of control resulting in injury.

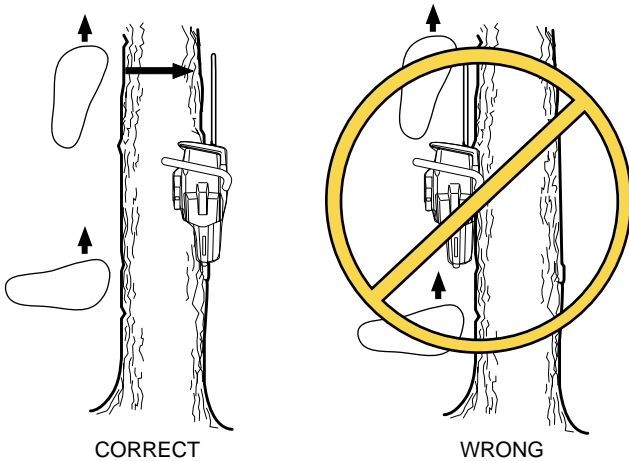

CORRECT

WRONG

1. Stand on the left side of the trunk.
2. Maintain a secure footing and rest the saw on the trunk.
3. Maintain full control, by holding saw close to you.

WARNING!

Keep well away from chain.

4. Move only when the trunk is between you and the chain. As shown.

CAUTION!

Watch out for springback from limbs under tension.

BASIC WORKING TECHNIQUES

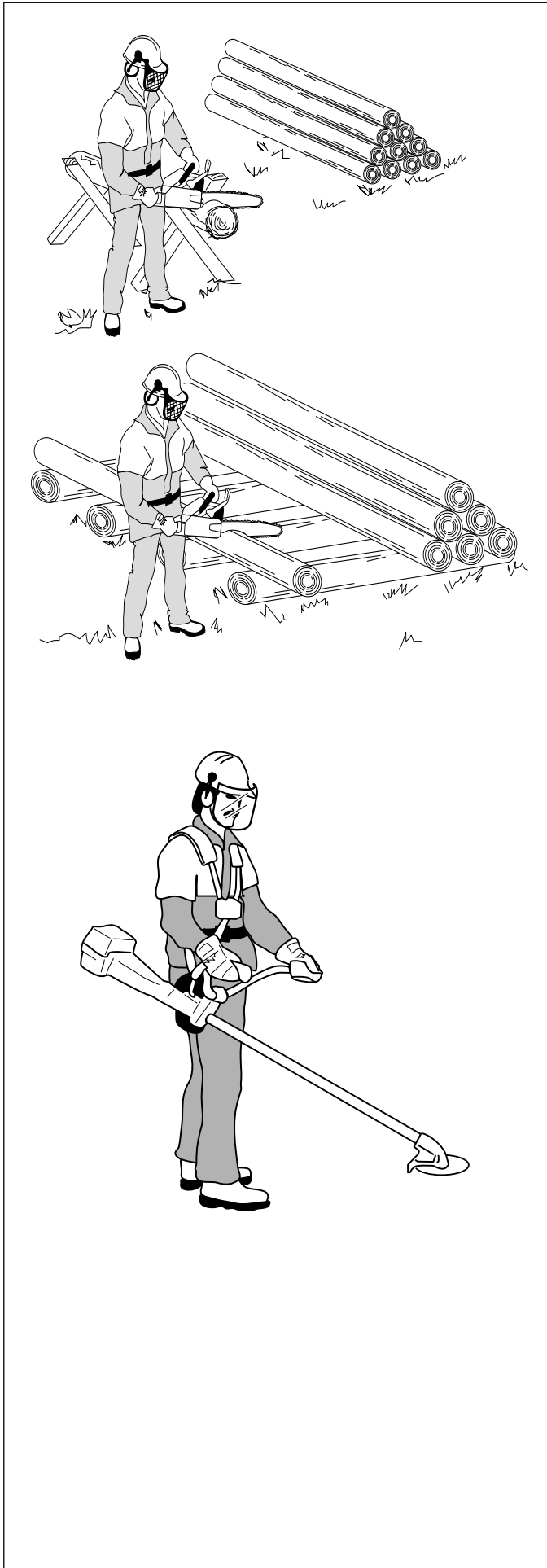

Cutting Logs

WARNING!

Never attempt to cut logs while they are in a pile or when a couple of logs are lying together. Such procedures drastically increase the risk of kickback which can result in a serious or fatal injury.

If you have a pile of logs, each log you attempt to cut should be removed from the pile, placed on a saw horse or runners and cut individually.

Remove the cut pieces from the cutting area. By leaving them in the cutting area, you increase the risk for inadvertently getting a kickback, as well as increasing the risk of losing your balance while working.

Cutting Shrubs, Brush, etc.

WARNING!

Do not use a chain saw to cut shrubs, brush, etc. The possibilities of kickback are high. A kickback can cause severe injury. Use a brush cutter or other tool that has been designed for the purpose.

Do not use your chain saw to cut shrubs, brush, etc. The possibility of kickback is high. If the stands are close together, it might be impossible to avoid contact with the kickback zone.

A brush cutter has been specially designed for this purpose and can be used safely for all kinds of clearing operations. Your dealer will be happy to show the benefits of a brush cutter.

BASIC WORKING TECHNIQUES

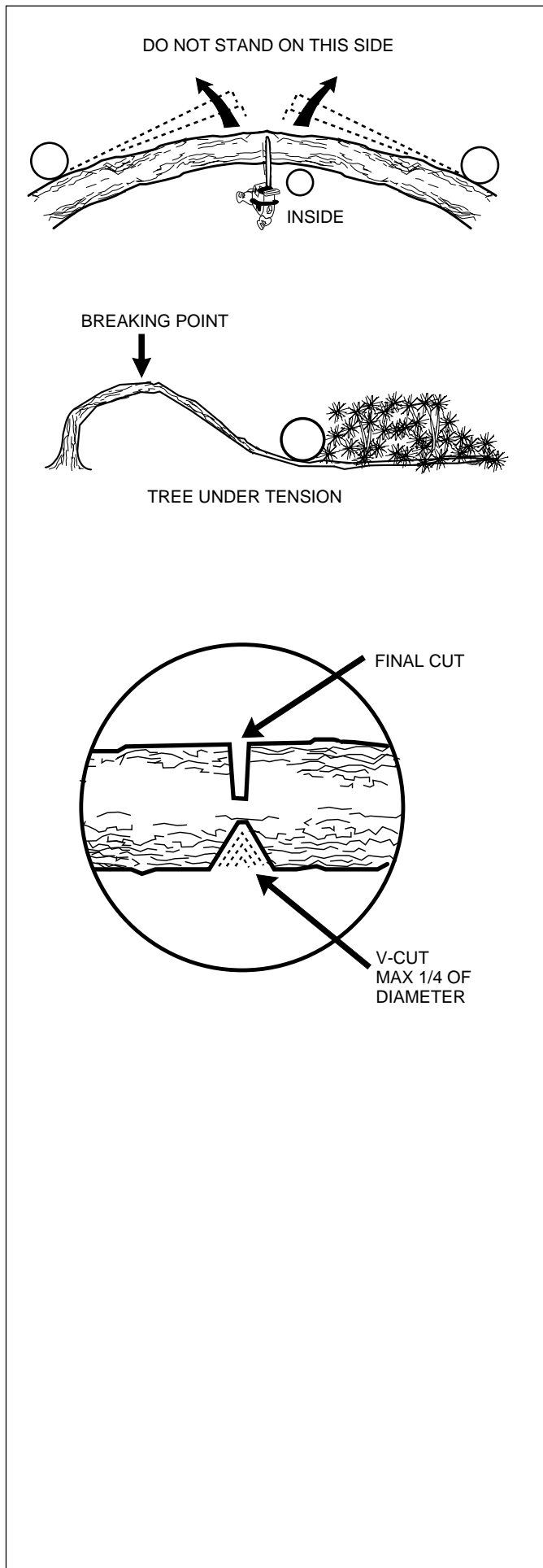

Cutting Trees or Limbs Under Tension

CAUTION!

Cutting trees or limbs under tension involves special hazards and must be done with care and planning. If the cut is made improperly, or you are in the wrong position, the tree may spring back at you and cause severe injury.

The cut should be made at the tree's breaking point: i.e., the point where the tree would break if it was bent further. That point is normally where the bend is most pronounced. At the breaking point, the forces are mainly trying to push the tree outward. If you are not cutting at the breaking point, the longest section of the stem, besides trying to push outwards, will also try to push along the trunk after it has broken. That makes the forces harder to predict and increases the danger.

WARNING!

Using improper techniques while cutting trees or limbs under tension can be extremely dangerous. The instructions above cover basic procedures but do not cover all possible situations you may encounter, such as multiple trees entangled in each other, dry wood, etc. Use extreme caution. Improper use may cause severe injury. Do not hesitate to get help if necessary.

BASIC WORKING TECHNIQUES

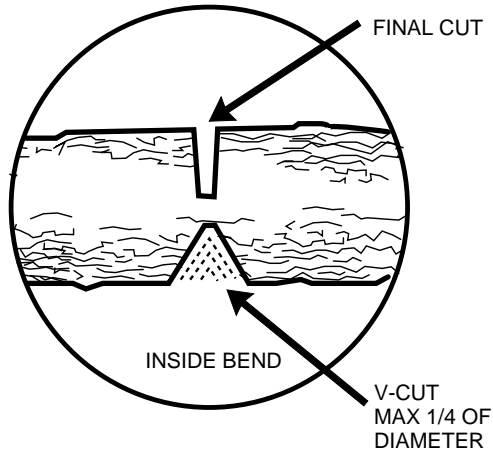

1. Position yourself inside the bend.
2. Start to cut a V-cut on your side, inside the bend. Cut up to 1/4 of the diameter of the trunk. Watch so the saw does not get pinched.
3. Remaining on the inside of the bend, move the saw over to the opposite side.
4. Cut slowly to reduce tension.

IMPORTANT!

To avoid pinching the saw when the first cut is made, it is recommended to make a V-cut. Make it in small steps as the illustration shows. This will cause the tree to break slowly, giving you time to back out of the way.

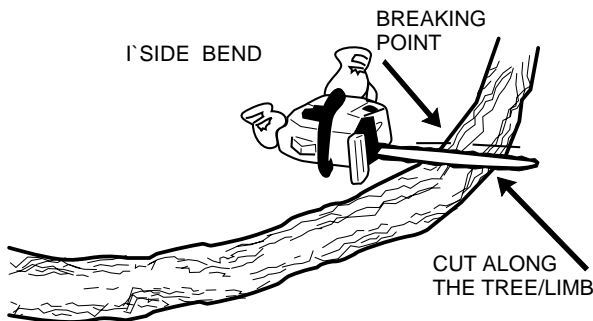

Small Trees and Limbs Under Tension

1. Always stay on the inside of the bend.
2. Make your cut at the breaking point.
3. If possible, cut along the tree/limb.
4. Cut slowly to relieve tension.

⚠ CAUTION!

Stay clear of tree/limb path.

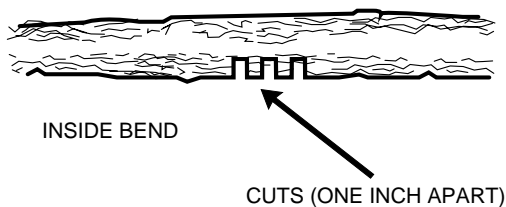

5. If you must cut across tree/limb, make two to three cuts, one inch apart, one to two inches deep.
6. Continue to cut deeper until tree/limb bends and tension is released.
7. Cut tree/limb from outside the bend, after tension has been released.

For Husqvarna Parts Call 606-678-9623 or 606-561-4983

For Husqvarna Parts Call 606-678-9623 or 606-561-4983