

Ref #	Part Number	Qty	S/P/F	Description
1A	A07134	1	S	SHORT BLOCK (30CC Non-Clutch Models)
1B	A07135	1	S	SHORT BLOCK (30CC Clutch Models)
2A	A03599	1	S	30CC PISTON ROD
3A	03379	2		RING-Piston
4A	A07146A	1	S	30CC CYLINDER KIT
5A	04388B	1	S/P	GASKET-Cylinder
6A	06900A	1	/P	GASKET-Heat Dam
11	98786C	1	/P	GASKET-Muffler
26	06443A	1	S/P	GASKET-Crankcase Cover
7	69250	1	/P	KEY-Woodruff
8	825691	3	/P	SCREW-Thread Form. (10-24 X 3/4")
4B	A07145	1	S	25CC CYLINDER KIT
5B	04388B	1	S/P	GASKET-Cylinder
6B	06900A	1	/P	GASKET-Heat Dam
11	98786C	1	/P	GASKET-Muffler
26	06443	1		GASKET-Crankcase Cover
2B	A04258	1	S	25CC PISTON & ROD
3B	96935	1	S	RING-Piston
A	A07142	1	S	MUFFLER KIT
9	82613	2	/P	SCREW-Machine (#10-24 X 2")
10	06502	1	/P	SCREEN-Spark
11	98786C	1	/P	GASKET-Muffler
12	80939	3	S	SCREW-Machine-Pan Slotted (8-32 X 3/4")
13	065011	1	/P	COVER
14	98768	1	S	HEAT DAM
15	825491	2	S	SCREW-Taptite (10-24 X 1")
B	A07139	1	S	CARBURETOR
16	987661	1	/P	GASKET-Carburetor
17	07377	1	S	LEVER-Choke Rod-(ZAMA)
	07376	1	/P	LEVER-Choke Rod-(WALBRO)
C1	A07140	1	/P	AIR FILTER KIT W/PUSH-BUTTON STOP
18	D06615	1	S	FILTER-Air
19	06618	1	S	BUTTON-Switch
20	95020	1	S	SPRING-Compression
21	82513	1	/P	SCREW-Plastite (#6-19 X 1/2")
22	81208	2	/P	NUT-HEX (10-24)
23	A07238	1	/P	LEAD-Electrical
24A	06622	1	S	COVER-Air Filter
C2	A07157	1		AIR FILTER KIT W/O PUSH-BUTTON STOP
18	D06615	1	S	FILTER-Air
22	81208	2	/P	NUT-Hex (10-24)
24B	07051	1	S	COVER-Air Filter
25	A07138	1	/P	CRANKCASE COVER
26	06443A	1	S/P	GASKET-Crankcase Cover
27	82563	3	/P	SCREW-Plastite (#10 X 3/4")
28	825491	4	S	SCREW-Taptite(10-24 X 5")
29	94711CS	1	/P	MODULE-Ignition
30	A33055	1	/P	TERMINAL & COVER
31	82540	2	/P	SCREW-Taptite (8-32 X 1")
32	79252	1	S	SPARK PLUG
33	04474	2	/P	SCREW-Machine (50-24 X 2 1/4")

i630cd String Trimmer UT-20627
Handle, Clutch & Starter

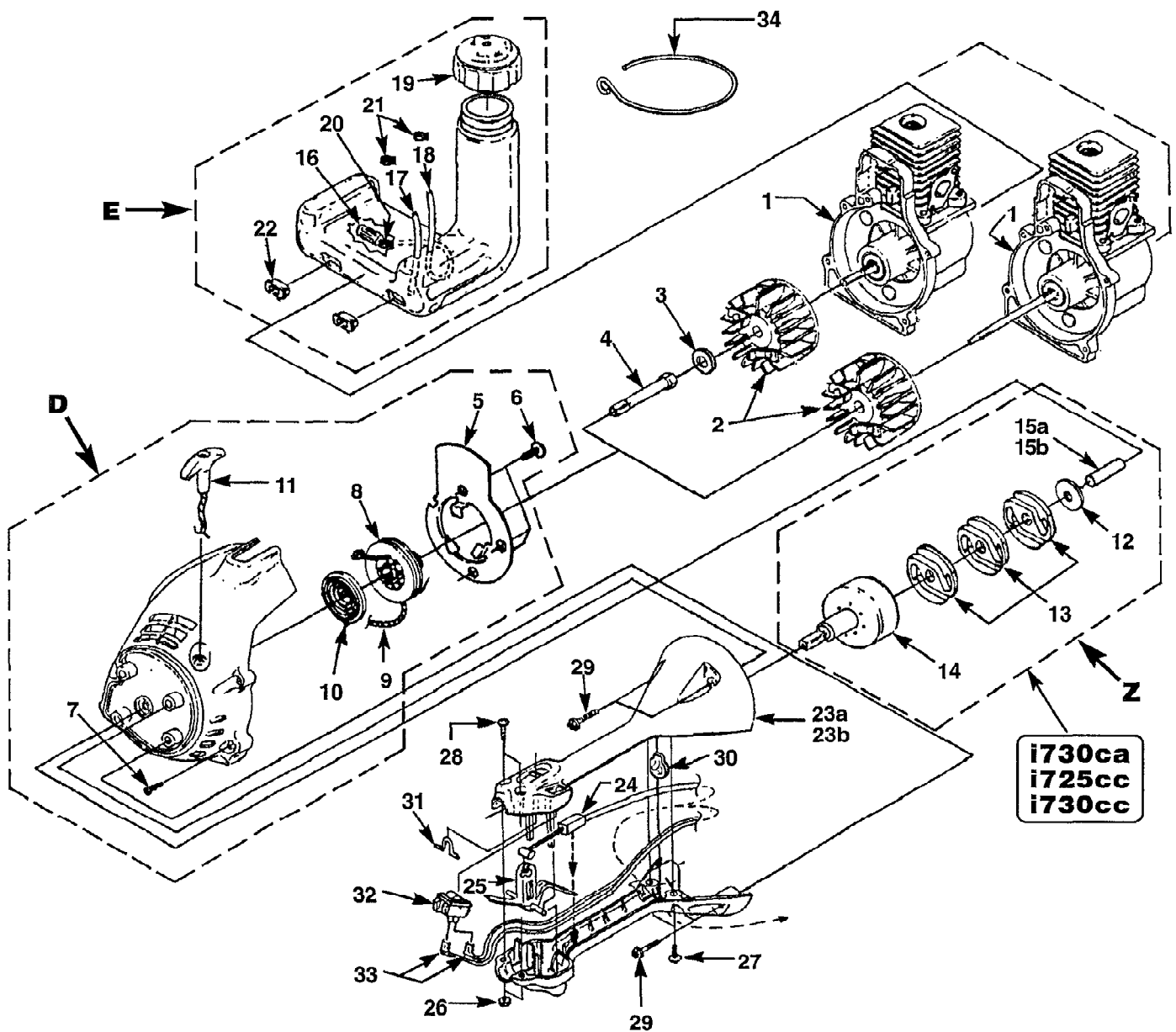

i630cd String Trimmer UT-20627
Handle, Clutch & Starter

Page 4 of 6

Ref #	Part Number	Qty	S/P/F	Description
1		1		SHORT BLOCK See "Engine" illustration and parts lists 1A & 1B for parts breakdown
2	A04158	1	S	ROTOR w/Starter Pawls
3	84065	1	S	WASHER-Flat (5/16)
4	98795A	1	/P	CONNECTOR-Drive
D	A07143	1	S	COMPLETE STARTER ASSEMBLY
5	06541A	1	S	PLATE-Baffle
6	82546	3	S/P	SCREW-Plastite (8-16 X 5/8")
7	82538	4	/P	SCREW-Thread Form. (10-24 X 3/4")
8	98770A	1	/P	PULLEY-Starter
9	9789902	1	S/P	ROPE-Starter (42")
10	A98773A	1	S/P	SPRING & CONTAINER
11	06598	1	S	GRIP-Starter
Z	A04655	1		CLUTCH & DRUM KIT (For Model i730ca, i725cc, i730cc)
12	98929A	1	S/P	WASHER-Flat
13	00242	3	/P	CLUTCH
14	A03485A	1	S	CONNECTOR DRUM
15A	035661	1	S	SPACER (30CC) 3 Shoe Clutch
15B	035662	1	S	SPACER (25CC) 2 Shoe Clutch
E	A07141B	1	S	FUEL TANK COMPLETE
16	49422	1	S	FILTER-Fuel
17	9477222	1	/P	TUBING-Rubber(5 1/2")
18	9477228	1		TUBING-Rubber (7")
19	A07234	1	S	FUEL CAP
20	98268	1	S/P	CLAMP
21	93426	2	/P	CLAMP
22	98792	4	/P	BUMPER-Rubber
23A	A07144	1		CONTROL HANDLE (W/O Switch)
24	06603A	1		CABLE-Throttle
25	06605	1		TRIGGER
26	81208	2	/P	NUT-Hex (#10-24)
27	82531	2	/P	SCREW-Plastite (#10-14 X 7/8")
28	82556	2	/P	SCREW-Machine (#10-24 X 1 1/4")
29	82558	4	/P	SCREW-Plastite (#10-14 X 1 1/8")
30	06620	1	/P	STOP-Drive Shaft
31	06802	1	/P	HOOK-Strap
23B	A07158	1		CONTROL HANDLE (Ignition Switch Models); (Includes 24-31)
32	07920	1	S	SWITCH-Rocker
33	A07149	2	S	LEADS-Electrical
34	07183	1	S	SUPPORT-Wire

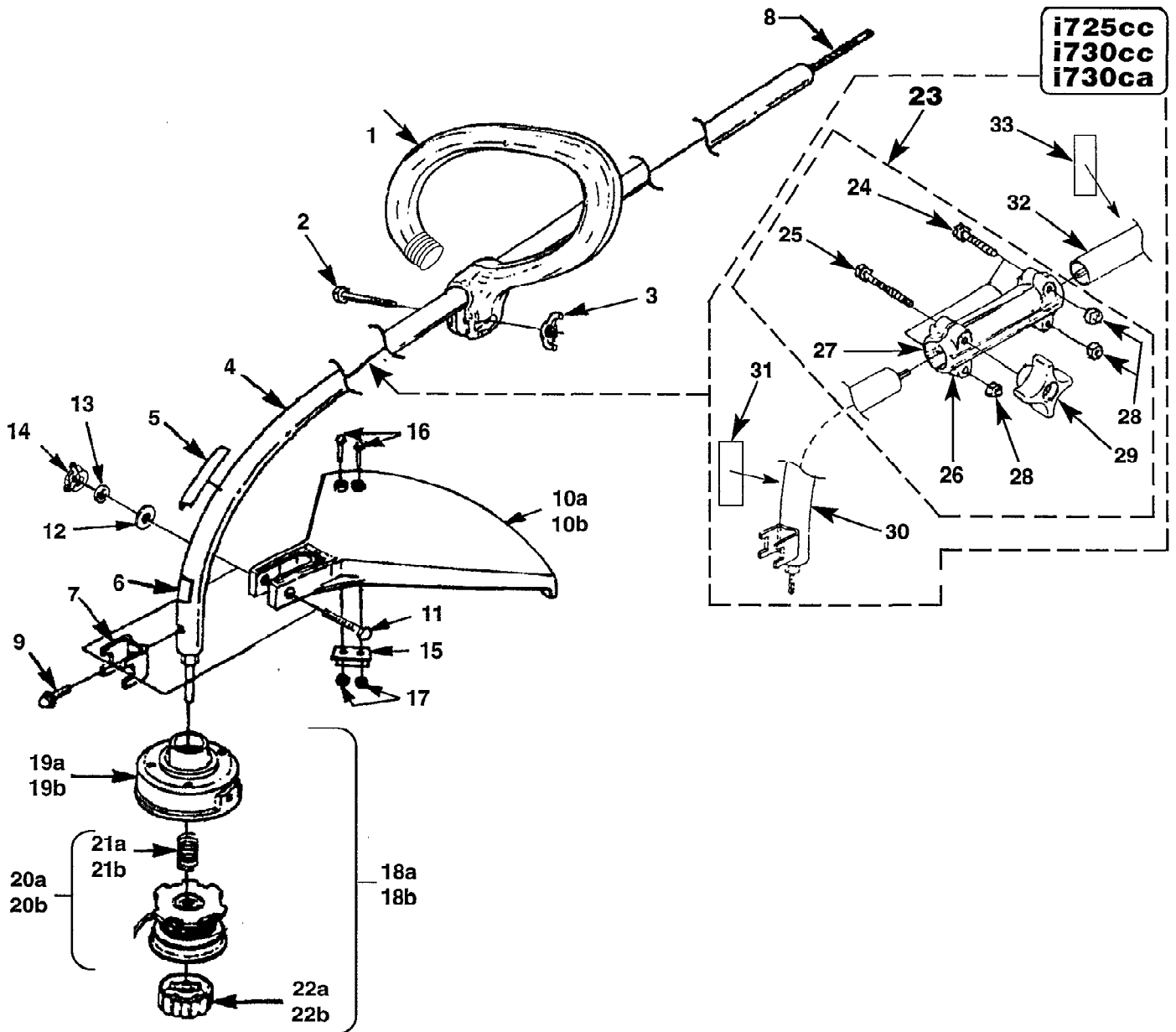

Ref #	Part Number	Qty	S/P/F	Description
1	A07136	1	S	FRONT HANDLE ("D")
2	802951	1	S	SCREW-Cap Hex Hd. (10-24 X 2")
3	93992	1	/P	NUT-Wing (10-24)
4	A04459	1	S	HOUSING-Drive Shaft
5	04458	1	S	DECAL-Starting Inst.
6	04679	1	S	DECAL-Warning
7	98853A	1	S	CLAMP
8	98816	1	S	SHAFT-Flexible
9	82541	1	/P	SCREW-Drilling (#10 X 1/2")
?10	A04704	1	S	DEFLECTOR & BLADE (100 Degree)
10A		1		UNKNOWN
10B		1		UNKNOWN
11	80295	1	/P	SCREW-Cap Hex Hd. (1/4-20 X 2")
12	84006	1	/P	WASHER-Flat (1/4")
13	83009	1	/P	WASHER-Lock (1/4")
14	81242	1	/P	NUT-Hex (1/4-20)
15	A03832	1	S	BLADE-Cut-Off Kit
16	82531	2	/P	SCREW-Mech. Hex Hd. (10-24 X 7/8")
17	81261	2	/P	NUT-Hex (10-24)
18A	DA03001A	1	S/P	STRINGHEAD-Complete (.080" Line)
19A	A98231A	1	S/P	HOUSING & EYELET (Dual Line)
20A	DA98912E	1	S	SPOOL & STRING & SPRING (.080" Line)
21A	06713	1	/P	SPRING-Compression
22A	DA98866A	1	S	RETAINER-Spool (R.H. Thread, Black)
18B	DA04591A	1	S/P	STRING HEAD COMPLETE (.095" Line) For model i630cd, i730cc, i730ca
19B	A98231A	1	S/P	HOUSING & EYELET (Dual Line)
20B	DA02598C	1	S	SPOOL & STRING & SPRING (.095" Line)
21B	06713	1	/P	SPRING-Compression
22B	DA98866A	1	S	RETAINER-Spool (R.H. Thread, Black)
23	A07901	1	/P	COUPLER ASSEMBLY For model i730ca
24	82278	3	/P	BOLT-Hex Hd.3
25	80295	1	/P	SCREW-Cap Hex (1/4-20 x 2")
26	GM236111	1	S	SPLIT BOOM (L.H.)
27	GM236112	1	S	SPLIT BOOM (R.H.)
28	81267	3	/P	NUT-Hex (1/4-20)
29	GM285204	1	S	KNOB
30	A07903	1	S	DRIVE SHAFT HOUSING-Curved (Lower)
31	04154	1		DECAL-Warning
7	98853A	1	S	CLAMP
9	82541	1	/P	SCREW-Drilling (#10 X 1/2")
32	A07902	1	S	DRIVE SHAFT HOUSING-(Upper)
33	04458	1	S	DECAL-Start Instructions