

No
Diagram
Available

Parts List
Only

Ref #	Part Number	Qty	S/P/F	Description
	18453	1	/P	GREASE, MULTI-PURPOSE
	PS24306	1	/P	MODULE AIR GAP SHIM
	A04191	1		GRASS ANTI-WRAP KIT
	98052A	1	/P	STARTER ROPE (250 Ft. Reel)
	UP06544	1	/P	TORX BIT (T25) (For Clutch Drums)
	UP07160	1	S/P	TORX BIT (T27)
	JA313164	1		IGNITION TEST SPARK PLUG
	UP05860	1	S/P	RUBBER TUBING (10 Ft.)
	DA03001A	1	S/P	STRINGHEAD-Complete - E-Z Line(TM) (.080 Line) (Right Hand Thread) (Black Retainer)
	DA04592A	1	S/P	STRINGHEAD-Complete - E-Z Line(TM) (.080 Line) (Left Hand Thread) (Red Retainer)
	9801106	1		REPLACEMENT STRING - E-Z Line(TM) (3 lb. Box) (.080" Dia.)
	DA04591A	1	S/P	STRINGHEAD-Complete - E-Z Line(TM) (.095 Line) (Right Hand Thread) (Black Retainer)
	DA03174A	1	S/P	STRINGHEAD-Complete - E-Z Line(TM) (.095 Line) (Left Hand Thread) (Red Retainer)
	0395904	1		REPLACEMENT STRING - E-Z Line(TM) (3 lb. Box) (.095" Dia.)
	DA09364	1	S	STRINGHEAD-Complete-Pro-Cut(TM) Fixed Line Head (.105" Dia.)
	D09365	1	S	REPLACEMENT Dura Line(TM) (.105" Dia.) (Cartridges for Pro-Cut(TM) Fixed Line Head)
	A06933	1		SAFETY GOGGLES
	UP03036	1	/P	DUST MASK
	UP00108	1	S	COMFORT STRAP FOR USE ON BRUSHCUTTER UNITS ONLY
	D98717C	1	S/P	TRI-ARC(TM) BLADE

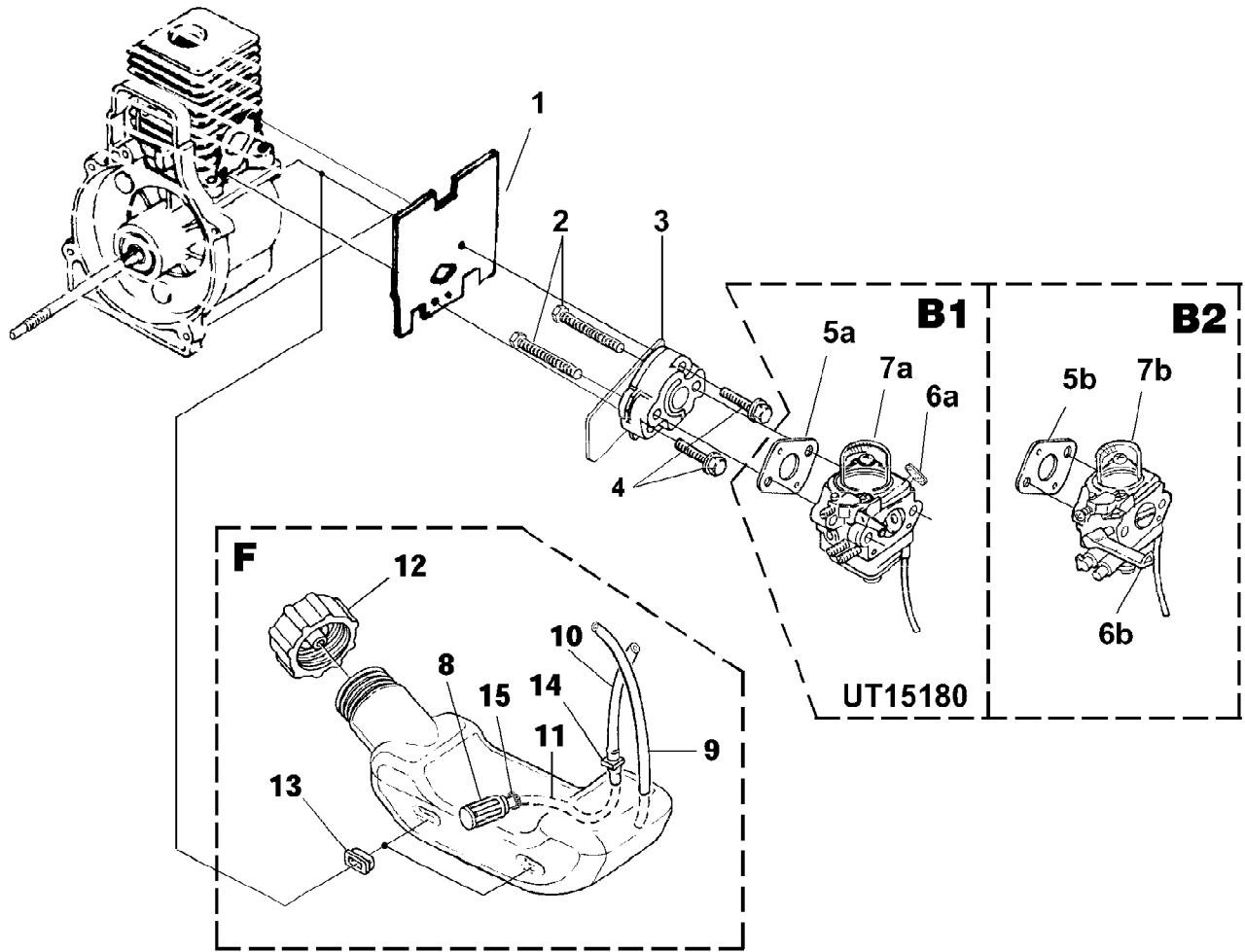

d825sd String Trimmer UT-20784
Carburetor - Fuel Tank

Page 4 of 12

Ref #	Part Number	Qty	S/P/F	Description
1	UP04308	1	S/P	GASKET-Heat Dam
2	UP04131	2		SCREW-Machine (10-24 X 2 1/4")
3	UP04348	1	S	HEAT DAM
4	UP04140	2	S	SCREW-Sems (10-24 X 1") Torque Specs 35-45 In/Lbs; 4.0-5.1 Nm; Required Loctite Red 262
B1	UP00654	1	/P	CARBURETOR KIT (UT15180)
5A	UP03916	1	S	GASKET-Carburetor
6A	UP04278	1	/P	Lever-Choke (Zama)
7A	UP04803	1	/P	BULB-Primer
B2	UP04742	1	S	CARBURETOR KIT (Non-Clutch)
	UP05085	1	S	CARBURETOR KIT (Clutch)
5B	UP03916	1	S	GASKET-Carburetor
6B	UP04740	1	S	Lever-Choke
7B	UP04803	1	/P	BULB-Primer
F	UP00020	1	S	FUEL TANK ASSY.
8	UP03871	1	S/P	FILTER-Fuel
9	UP04293	1	S	TUBING-Rubber
10	0143910	1	/P	TUBING-Rubber
11	UP04715	1	S	TUBING-Rubber
12	UP00106	1	/P	FUEL CAP
13	UP03501	3	S	BUMPER-Rubber
14	UP03831	1	S	FITTING-Inline
15	UP03913	1	S	CLAMP

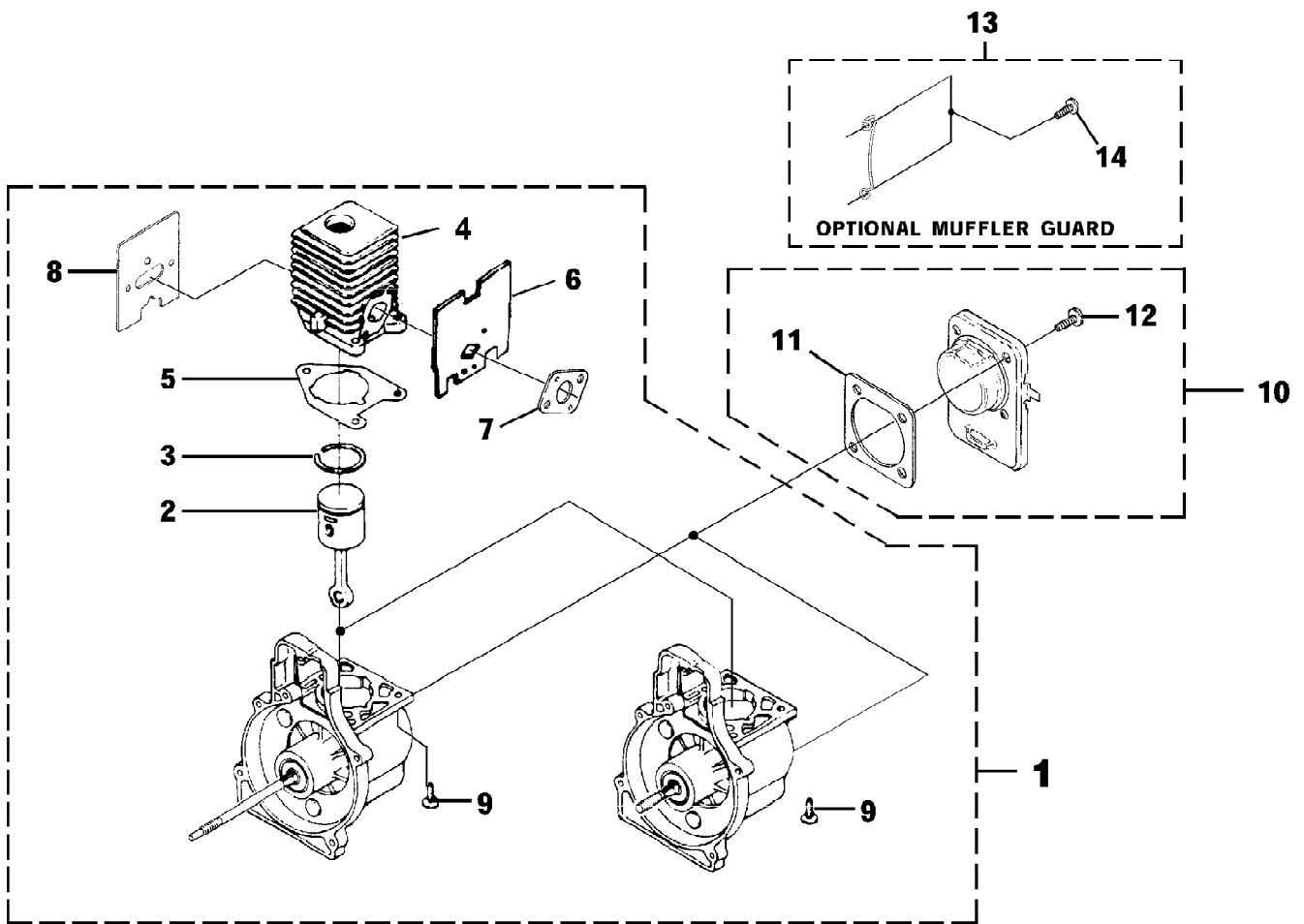

d825sd String Trimmer UT-20784
Engine Internal

Page 6 of 12

Ref #	Part Number	Qty	S/P/F	Description
1	UP02994	1	S	SHORT BLOCK (Non-Clutch)
	UP02995	1	S	SHORT BLOCK (Clutch)
2	UP00768	1	S/P	PISTON & ROD ASSY.
3	UP03838	1	S/P	RING-Piston
4	UP04136	1	S	CYLINDER ASSY.
5	UP03857	1	S/P	GASKET-Cylinder
6	UP04308	1	S/P	GASKET-Heat Dam
7	UP03916	1	S	GASKET-Carburetor
8	UP04710	1	S	GASKET-Muffler
9	UP04345	3	S/P	SCREW-Sems (12-24 X 3/4") Torque Specs 55-65 In/Lbs; 6.2-7.3 Nm; Required Loctite Red 262
10	UP00019	1	S	CRANKCASE COVER ASSEMBLY
11	UP04335	1	S	GASKET-Crankcase Cover (Also included w/short block)
12	UP04295	4	S/P	SCREW-Sems (10-24 X 1/2") Torque Specs 35-45 In/Lbs; 4.0-5.1 Nm; Required Loctite Red 262
13	UP04099	3	/P	MUFFLER GUARD
14	UP03897	2	S	SCREW-Plastite (10-14 X 1/2") Torque Specs 5-20 In/Lbs; .6-2.3 Nm

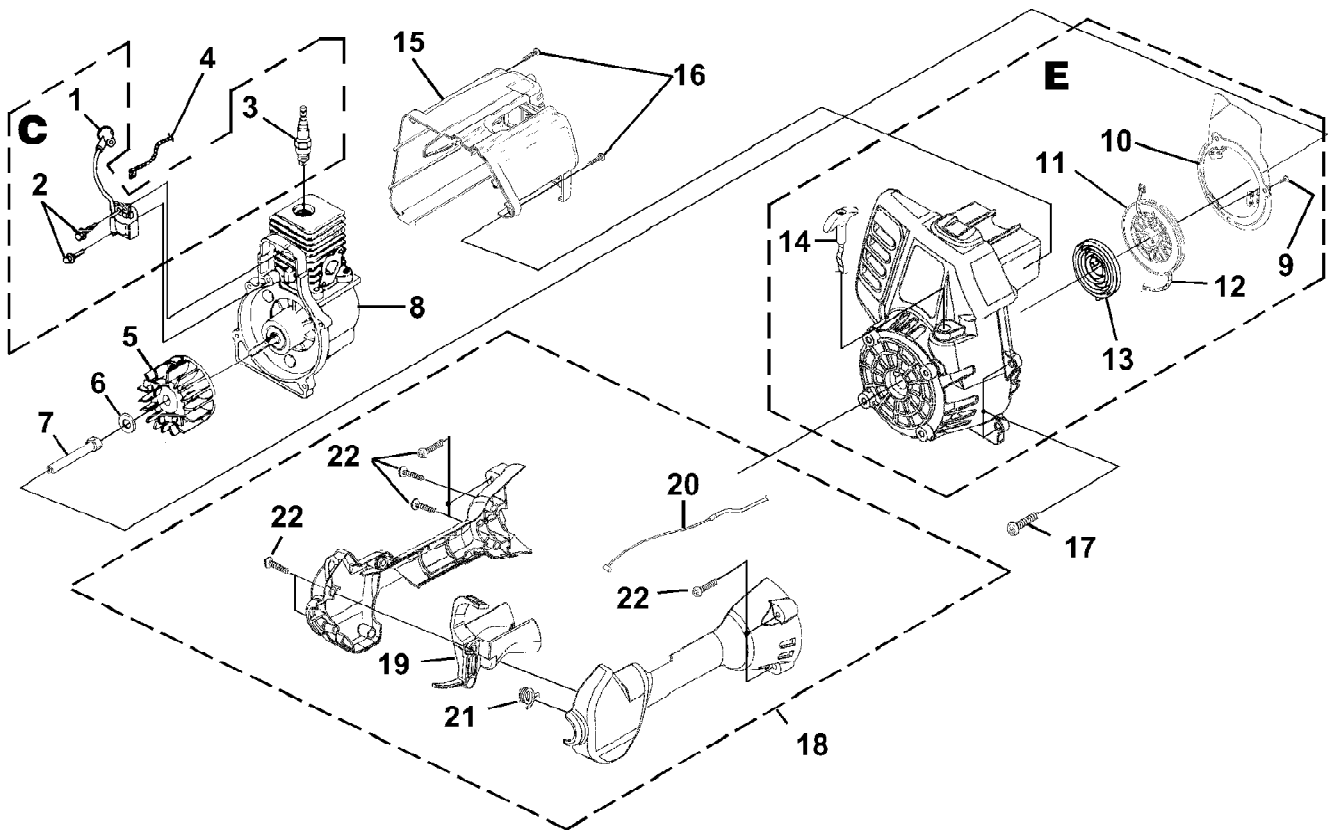

d825sd String Trimmer UT-20784
Ignition - Rotor - Starter

Page 8 of 12

Ref #	Part Number	Qty	S/P/F	Description
C	A07174	1	S	IGNITION KIT
1	UP03868	1	S/P	TERMINAL & COVER
2	UP03896	2	S/P	SCREW-Taptite (8-32 X 1") Torque Specs 30-40 In/Lbs; 3.4-4.5 Nm; Required Loctite Blue 242
3	UP03883	1	/P	SPARK PLUG Torque Specs 120-180 In/Lbs; 13.6-20.3 Nm
4	UP04690	1	S	LEAD-Electrical
5	UP03009	1		ROTOR KIT
6	UP03906	1	S/P	WASHER-Flat
7	UP04271	1	S	CONNECTOR-Drive (.250) Torque Specs 100-150 In/Lbs; 11.3-16.9 Nm
8	UP02994	1	S	SHORT BLOCK (See "Engine Internal" illustration & parts list)
E	UP02963	1		COMPLETE STARTER ASSEMBLY
9	UP04164	3	S	SCREW-Thread Form (8-16 X 1/2") Torque Specs 10-20 In/Lbs; 1.1-2.3 Nm
10	UP03013	1	S	BAFFLE-Air
11	UP03012	1	S	PULLEY-Starter
12	UP03912	1	S	ROPE-Starter (42")
13	UP03917	1	S	SPRING & CONTAINER
14	UP03026	1	S	GRIP-Starter (Yellow)
15	UP02964	1		HOUSING-Rear Kit
16	UP03900	2	S/P	SCREW-Taptite (10-14 X 3/4") Torque Specs 30-50 In/Lbs; 3.4-5.6 Nm
17	UP03406	4	S	SCREW-Taptite (10-24 X 3/4") Torque Specs 30-40 In/Lbs; 3.4-4.5 Nm
18	UP03113	1	/P	CONTROL HANDLE ASSY. Includes items 19-22
19	UP03207	1	S/P	TRIGGER
20	UP03172	1	S	CABLE-Throttle
21	UP03210	1	S	SPRING
22	UP04247	9	S	SCREW-Truss Hd. (10-14 x 1") Torque Specs 30-50 In/Lbs; 3.4-5.6 Nm

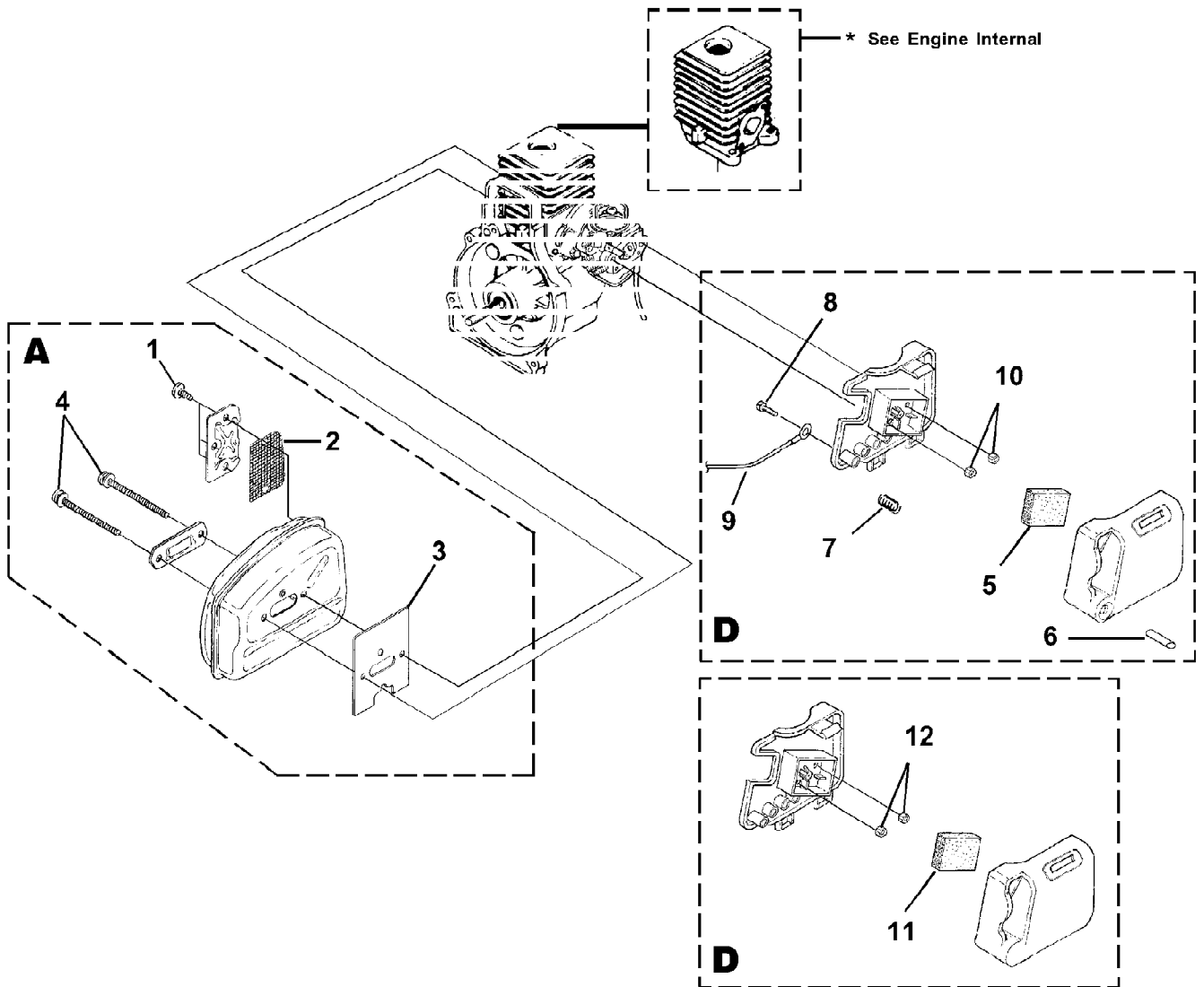

d825sd String Trimmer UT-20784
Muffler - Air Cleaner

Page 10 of 12

Ref #	Part Number	Qty	S/P/F	Description
A	UP04634	1	S/P	MUFFLER ASSY.
1	UP04258	3	S	SCREW, Taptite- (8-32 X 3/8") Torque Specs 25-35 In/Lbs; 2.8-4.0 Nm
2	UP04629	1	S	SCREEN-Spark
3	UP04710	1	S	GASKET-Muffler
4	UP04258	2	S	SCREW, Truss Hd. - (10-24 X 2.188) Torque Specs 50-60 In/Lbs; 5.6-6.8 Nm
D	UP04741	1	S	AIR FILTER KIT (Non-Clutch)
5	D98760B	1	S	FILTER-Air
6	UP04687	1	S/P	BUTTON-Switch
7	UP04716	1	S/P	SPRING-Compression
8	UP04082	1	S	SCREW-Thread Form (6-19 x 1/2") Torque Specs 5-10 In/Lbs; .6-1.1 Nm
9	UP04690	1	S	LEAD-Electrical
10	UP03885	2	S	NUT-Hex (10-24) Torque Specs 30-40 In/Lbs; 3.4-4.5 Nm
D	UP05084	1	S	AIR FILTER KIT (Clutch)
11	D98760B	1	S	FILTER-Air
12	UP03885	2	S	NUT-Hex (10-24) Torque Specs 30-40 In/Lbs; 3.4-4.5 Nm

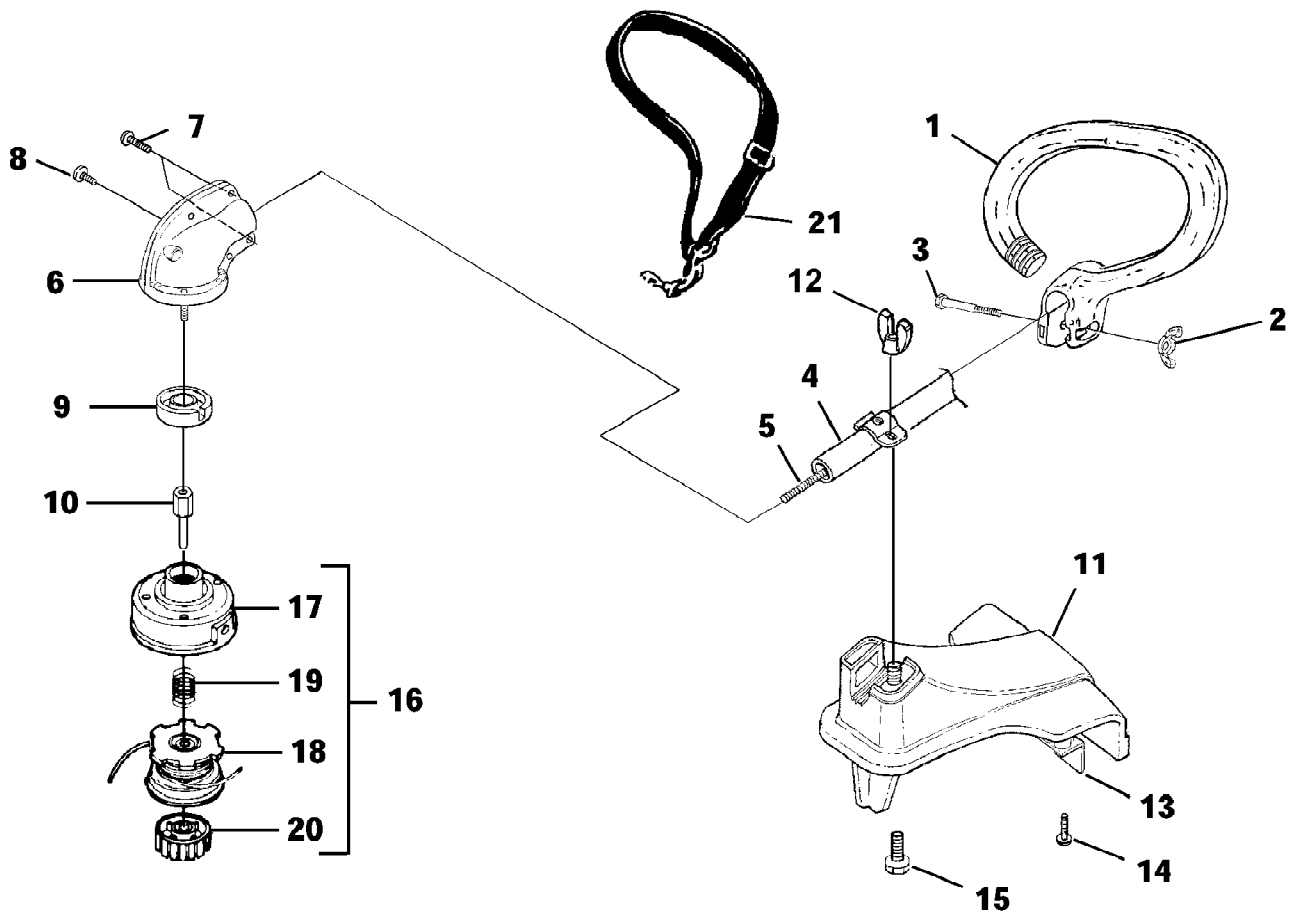

d825sd String Trimmer UT-20784
Shaft - Spool & String - Grass Deflector

Page 12 of 12

Ref #	Part Number	Qty	S/P/F	Description
1	UP06959	1	S/P	HANDLE-Anti-Vibe
2	UP04262	1	S/P	NUT-Wing, Washer Faced (1/4-20) Torque Specs Hand Tight
3	UP06523	1	S/P	SCREW-Cap Hex Hd. (1/4-20 x 2")
4	UP04891	1	S	DRIVESHAFT HOUSING ASSY.
5	UP04717	1	S	SHAFT-Flexible
6	UP06970	1	/P	GEARHEAD
7	UP04157	5	S/P	Screw, Taptite Hex Hd. (10-24 x 1/2") Torque Specs 15-20 In/Lbs; 1.7-2.3 Nm
8	UP04155	2	S	Screw-Hex Hd. (10-24 x 5/8") Torque Specs 40-50 In/Lbs; 4.5-5.6 Nm
9	UP04126	1	S/P	WASHER-Flanged
10	UP04128	1	S	ADAPTER-Shaft Torque Specs 100-120 In/Lbs; 11.3-13.6 Nm
11	UP04888	1	S	GRASS DEFLECTOR KIT
12	UP04893	1	S	WING NUT Torque Specs Hand Tight
13	UP04890	1		BLADE-Cut-off
14	UP03898	2	S	SCREW-Mach.Hex Hd. (10-24 X 3/8") Torque Specs 30-40 In/Lbs; 3.4-4.5 Nm
15	UP04892	1	S	SCREW-Square Head
16	DA03001A	1	S/P	STRINGHEAD-Complete (.080") (UT20818)
	DA04591A	1	S/P	STRINGHEAD-Complete (.095")
17	UP06567	1	S	HOUSING & EYELET (Dual Line)
18	UP00145	1	S/P	SPOOL & STRING (.080")
	UP00147	1	S/P	SPOOL & STRING (.095")
19	UP06526	1	S/P	SPRING-Compression
20	DA98866A	1	S	RETAINER-Spool (R.H. Thread, Black)
21	UP00108	1	S	HARNESS