

No  
Diagram  
Available  
  
Parts List  
Only

Trim N' Edge String Trimmer UT-20728  
Accessories

Page 2 of 12

Ref #	Part Number	Qty	S/P/F	Description
	18453	1	/P	GREASE, MULTI-PURPOSE
	PS24306	1	/P	MODULE AIR GAP SHIM
	A04191	1		GRASS ANTI-WRAP KIT
	98052A	1	/P	STARTER ROPE (250 Ft. Reel)
	UP06544	1	/P	TORX BIT (T25) (For Clutch Drums)
	UP07160	1	S/P	TORX BIT (T27)
	JA313164	1		IGNITION TEST SPARK PLUG
	UP05860	1	S/P	RUBBER TUBING (10 Ft.)
	DA03001A	1	S/P	STRINGHEAD-Complete - E-Z Line(TM) (.080 Line) (Right Hand Thread) (Black Retainer)
	9801106	1		REPLACEMENT STRING - E-Z Line(TM) (3 lb. Box) (.080" Dia.)
	DA04591A	1	S/P	STRINGHEAD-Complete - E-Z Line(TM) (.095 Line) (Right Hand Thread) (Black Retainer)
	0395904	1		REPLACEMENT STRING - E-Z Line(TM) (3 lb. Box) (.095" Dia.)
	DA09364	1	S	STRINGHEAD-Complete-Pro-Cut(TM) Fixed Line Head (.105" Dia.)
	D09365	1	S	REPLACEMENT Dura Line(TM) (.105" Dia.) (Cartridges for Pro-Cut(TM) Fixed Line Head)
	A06933	1		SAFETY GOGGLES
	UP03036	1	/P	DUST MASK
	UP00108	1	S	COMFORT STRAP
	D98717C	1	S/P	TRI-ARC(TM) BLADE FOR USE ON BRUSHCUTTER UNITS ONLY

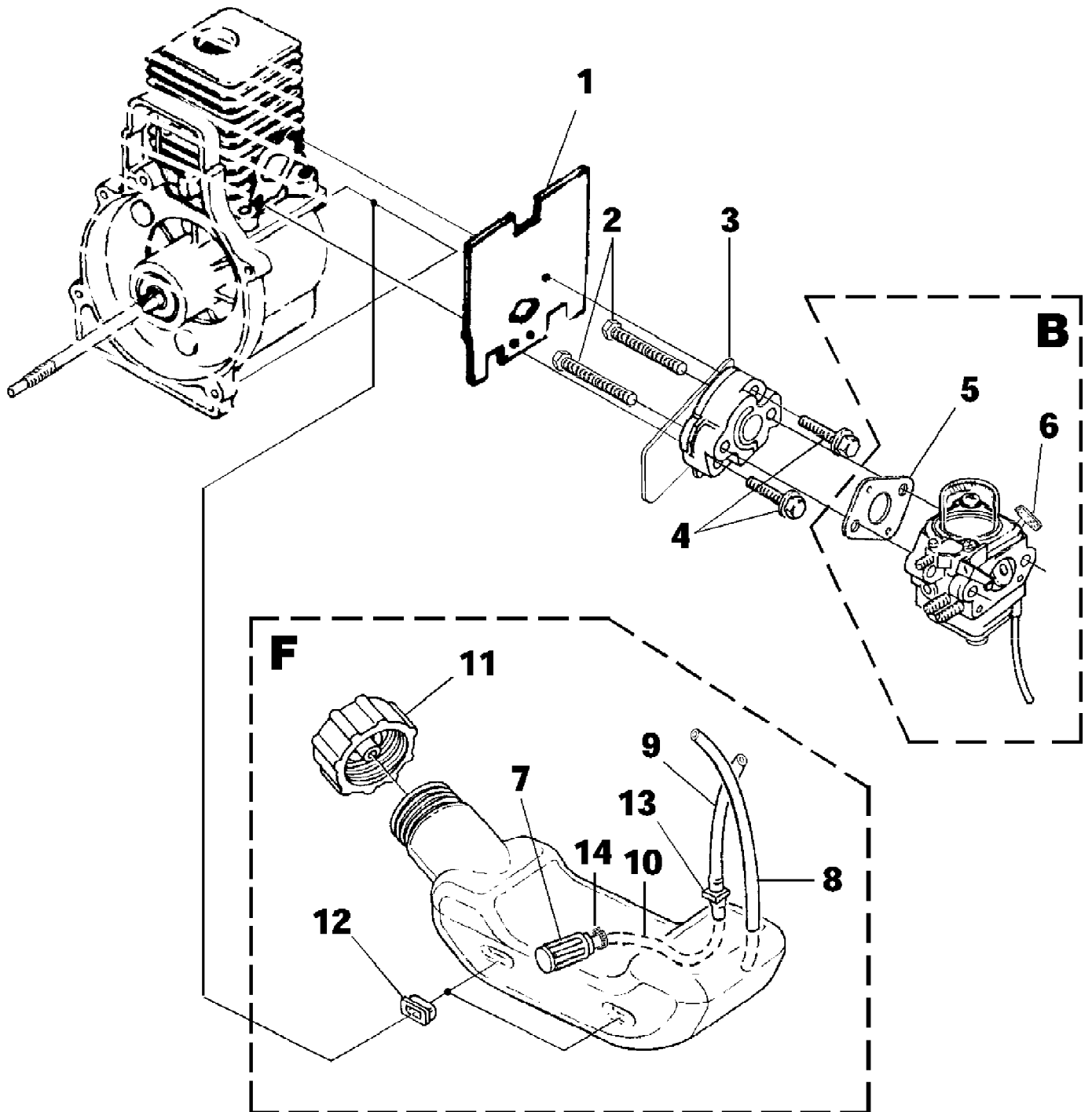

Trim N' Edge String Trimmer UT-20728  
Carburetor - Fuel Tank

Page 4 of 12

Ref #	Part Number	Qty	S/P/F	Description
1	UP04308	1	S/P	GASKET-Heat Dam
2	UP04131	2		SCREW-Machine (10-24 X 2 1/4")
3	UP04348	1	S	HEAT DAM
4	UP04140	2	S	SCREW-Sems (10-24 X 1") Torque Specs 35-45 In/Lbs, 4.0-5.1 Nm. Required Loctite Red 262
B	UP00608	1	S	CARBURETOR KIT (Non-Clutch) Includes items 5-6
	UP00654	1	/P	CARBURETOR KIT (Clutch) Includes items 5-6
5	UP03916	1	S	GASKET-Carburetor
6	UP04278	1	/P	Lever-Choke (Zama)
F	UP00020	1	S	FUEL TANK ASSY. Includes items 7-14
7	UP03871	1	S/P	FILTER-Fuel
8	UP04293	1	S	TUBING-Rubber
9	UP04292	1	S	TUBING-Rubber
10	UP04715	1	S	TUBING-Rubber
11	UP00106	1	/P	FUEL CAP
12	UP03501	3	S	BUMPER-Rubber
13	UP03831	1	S	FITTING-Inline
14	UP03913	1	S	CLAMP

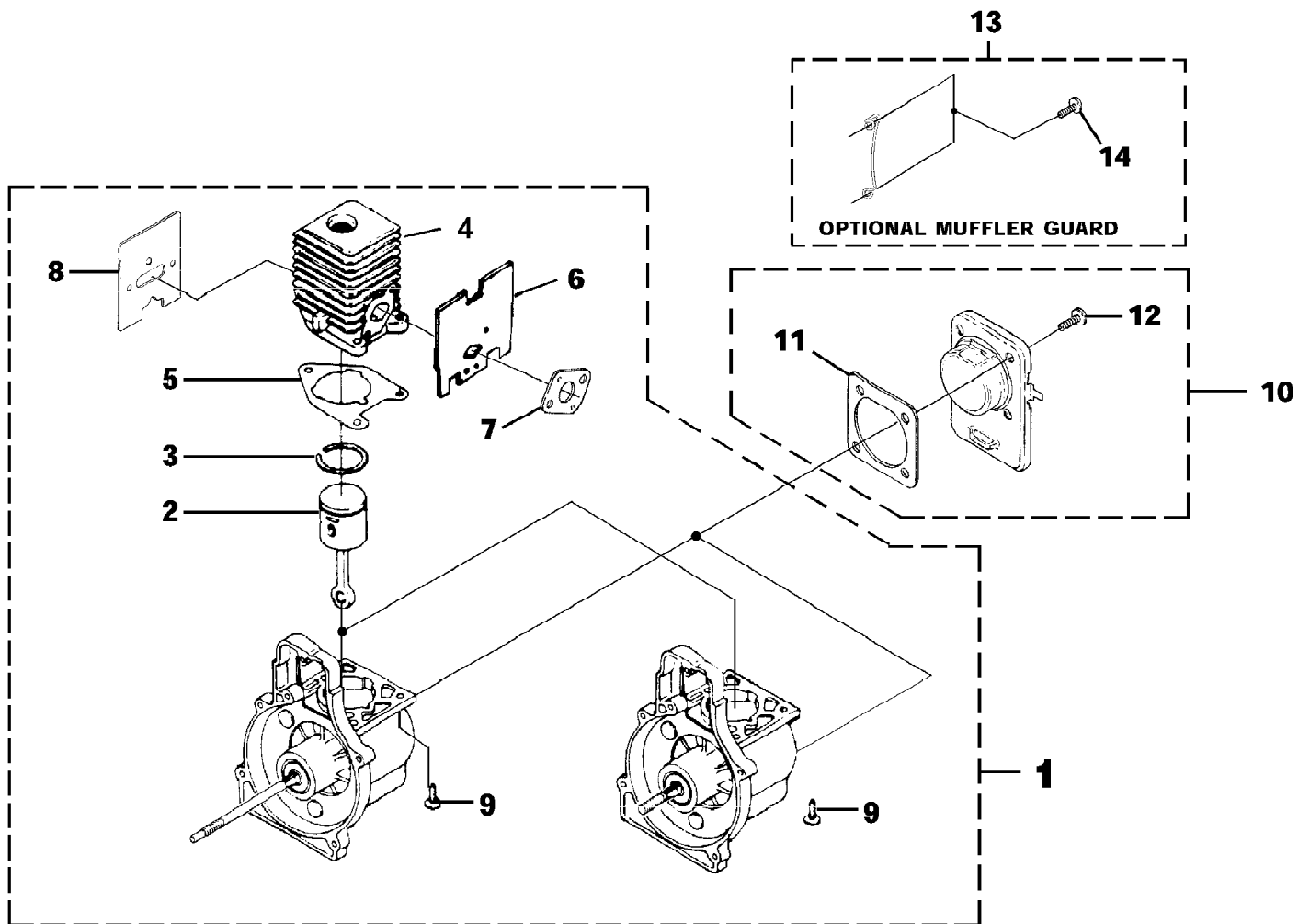

Trim N' Edge String Trimmer UT-20728  
Engine Internal

Page 6 of 12

Ref #	Part Number	Qty	S/P/F	Description
1	UP02994	1	S	SHORT BLOCK (Non-Clutch) Includes items 2-9
	UP02995	1	S	SHORT BLOCK (Clutch) Includes items 2-9
2	UP00768	1	S/P	PISTON & ROD ASSY. Includes item 3
3	PS01359	1	S/P	RING-Piston
4	UP04136	1	S	CYLINDER ASSY. Includes items 5-8
5	UP03857	1	S/P	GASKET-Cylinder
6	UP04308	1	S/P	GASKET-Heat Dam
7	UP03916	1	S	GASKET-Carburetor
8	UP04710	1	S	GASKET-Muffler
9	UP04345	3	S/P	SCREW-Sems (12-24 X 3/4") Torque Specs 55-65 In/Lbs, 6.2-7.3 Nm. Required Loctite Red 262
10	UP00019	1	S	CRANKCASE COVER ASSEMBLY Includes items 11-12
11	UP04335	1	S	GASKET-Crankcase Cover (Also included w/short block)
12	UP04295	4	S/P	SCREW-Sems (10-24 X 1/2") Torque Specs 35-45 In/Lbs, 4.0-5.1 Nm. Required Loctite Red 262
13	UP00027	3	S	MUFFLER GUARD Includes item 14
14	UP03897	2	S	SCREW-Plastite (10-14 X 1/2") Torque Specs 5-20 In/Lbs, .6-2.3 Nm.

Trim N' Edge String Trimmer UT-20728  
Ignition - Rotor - Starter

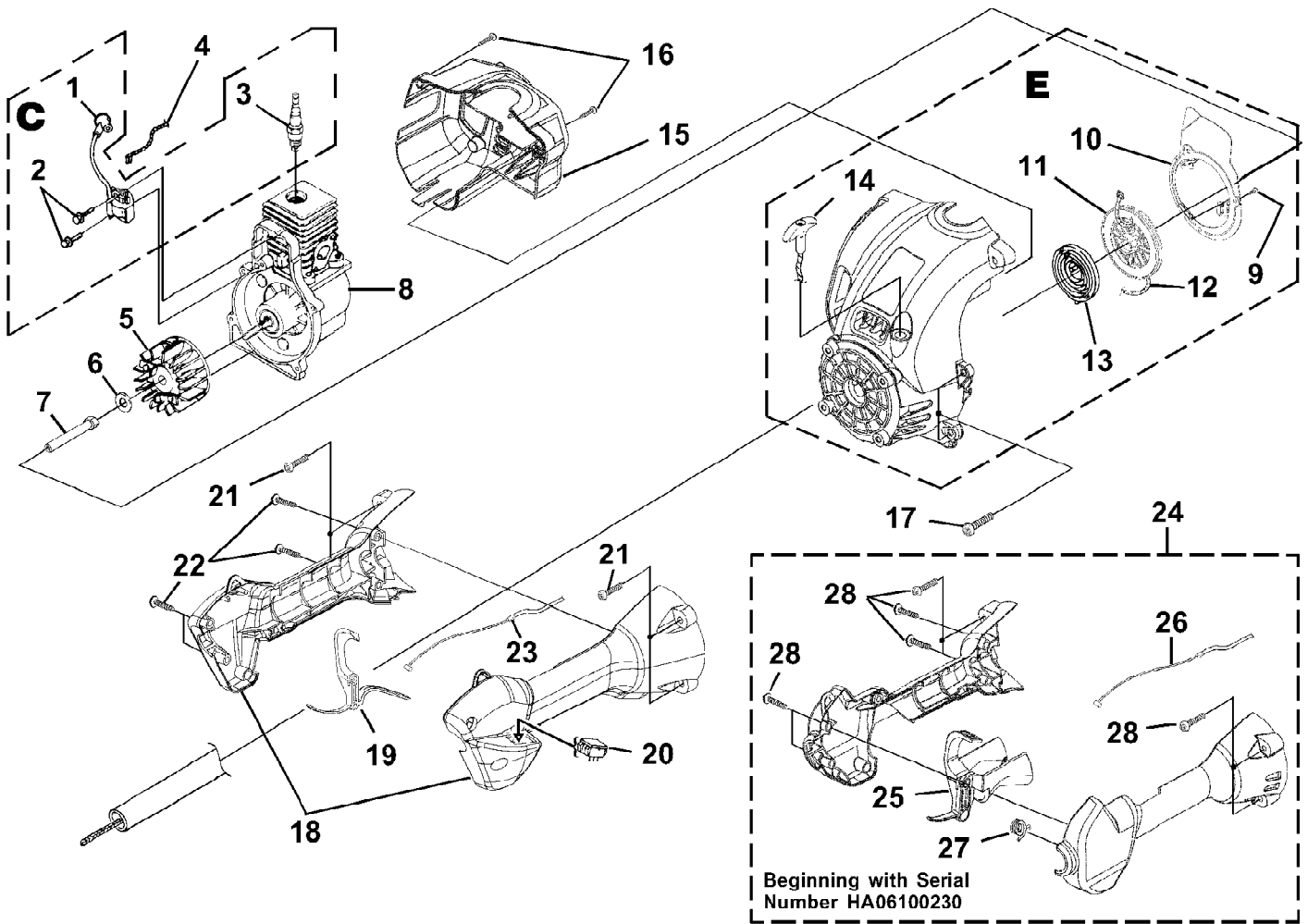

Trim N' Edge String Trimmer UT-20728  
Ignition - Rotor - Starter

Page 8 of 12

Ref #	Part Number	Qty	S/P/F	Description
C	A07174	1	S	IGNITION KIT Includes items 1-3
1	UP03868	1	S/P	TERMINAL & COVER
2	UP03896	2	S/P	SCREW-Taptite (8-32 X 1") Torque Specs 30-40 In/Lbs, 3.4-4.5 Nm. Required Loctite Blue 242
3	UP03883	1	/P	SPARK PLUG Torque Specs 120-180 In/Lbs, 13.6-20.3 Nm.
4	UP04690	1	S	LEAD-Electrical
5	UP03009	1		ROTOR KIT Includes item 6
6	UP03906	1	S/P	WASHER-Flat
7	UP04271	1	S	CONNECTOR-Drive (.250) Torque Specs 100-150 In/Lbs, 11.3-16.9 Nm.
8	UP02994	1	S	SHORT BLOCK (See "Engine Internal" illustration and parts list)
E	UP02962	1	S	COMPLETE STARTER ASSEMBLY Includes items 9-14
9	UP04164	3	S	SCREW-Thread Form (8-16 X 1/2") Torque Specs 10-20 In/Lbs, 1.1-2.3 Nm.
10	UP03013	1	S	BAFFLE-Air
11	UP03012	1	S	PULLEY-Starter
12	UP03912	1	S	ROPE-Starter (42")
13	UP03917	1	S	SPRING & CONTAINER
14	UP03026	1	S	GRIP-Starter (Yellow)
15	UP02965	1		HOUSING-Rear Kit Includes item 16
16	UP03895	2	S	SCREW-Taptite (10-14 X 7/8") Torque Specs 30-50 In/Lbs, 3.4-5.6 Nm.
17	UP03406	4	S	SCREW-Taptite (10-24 X 3/4") Torque Specs 30-40 In/Lbs, 3.4-4.5 Nm.
18	UP03113	1	/P	CONTROL HANDLE ASSY. Includes items 19-22
19	UP03015	1	S/P	TRIGGER-Throttle
20	UP03027	1	S	PLUG-Switch
21	UP03895	4	S	SCREW-Taptite (10-14 X 7/8") Torque Specs 30-50 In/Lbs, 3.4-5.6 Nm.
22	UP04247	4	S	SCREW-Truss Hd. (10-14 x 1") Torque Specs 30-50 In/Lbs, 3.4-5.6 Nm.
23	UP03020	1	S	CABLE-Throttle Includes item 28
28	UP04247	9	S	SCREW-Truss Hd. (10-14 x 1")
24	UP03113	1	/P	CONTROL HANDLE ASSY. Includes items 25-28
25	UP03207	1	S/P	TRIGGER
26	UP03172	1	S	CABLE-Throttle
27	UP03210	1	S	SPRING
28	UP04247	9	S	SCREW-Truss Hd. (10-14 x 1") Torque Specs 30-50 In/Lbs, 3.4-5.6 Nm.



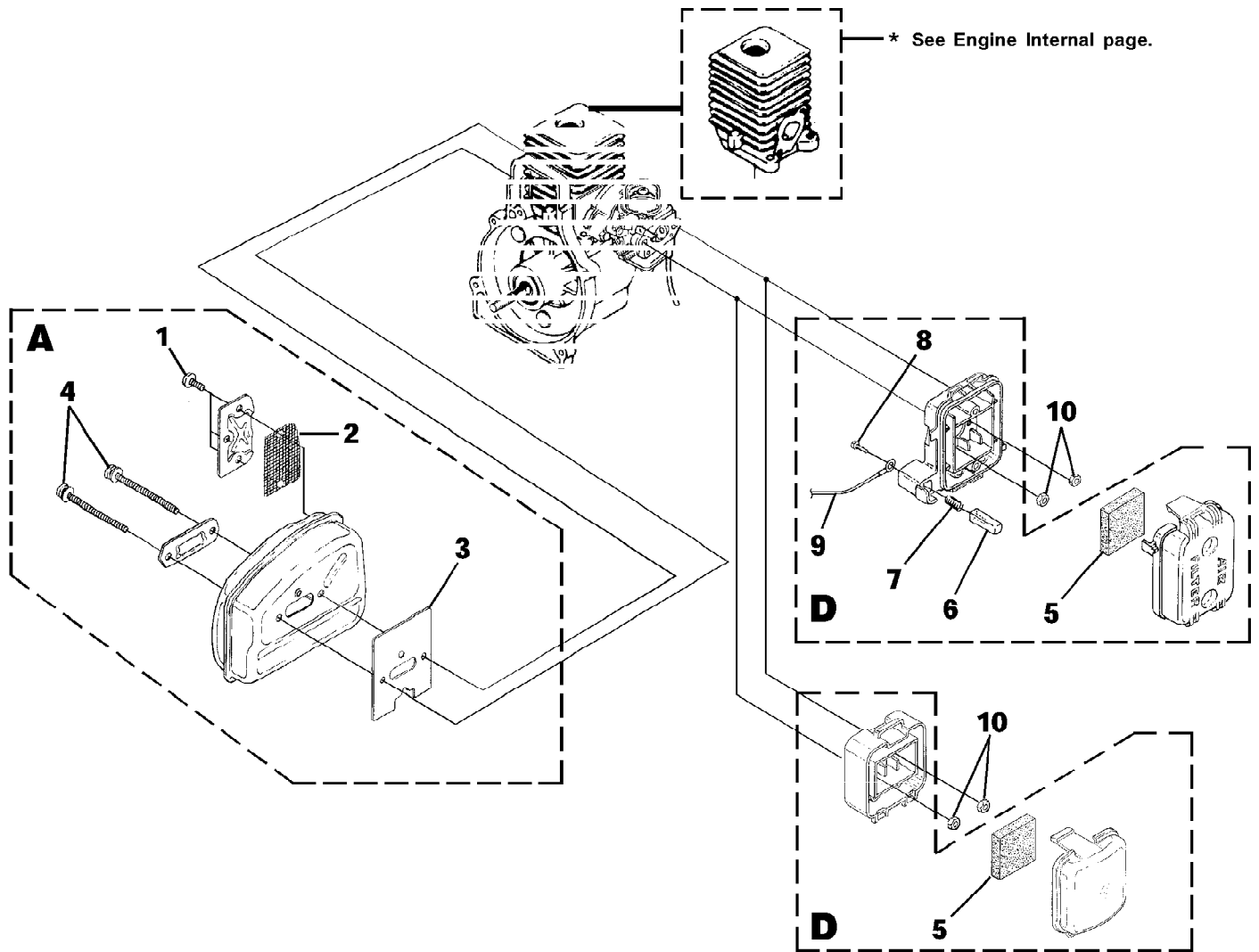

Trim N' Edge String Trimmer UT-20728  
Muffler - Air Cleaner

Page 10 of 12

Ref #	Part Number	Qty	S/P/F	Description
A	UP04634	1	S/P	MUFFLER ASSY. Includes items 1-4
1	UP04248	3	S	SCREW, Taptite- (8-32 X 3/8") Torque Specs 25-35 In/Lbs, 2.8-4.0 Nm.
2	UP04629	1	S	SCREEN-Spark
3	UP04710	1	S	GASKET-Muffler
4	UP04258	2	S	SCREW, Truss Hd. - (10-24 X 2.188) Torque Specs 50-60 In/Lbs, 5.6-6.8 Nm.
D	A04707A	1	/P	AIR FILTER KIT (Non-Clutch) Includes items 5-10
5	D98760B	1	S	FILTER-Air
6	UP06341	1	S	BUTTON-Switch
7	UP04716	1	S/P	SPRING-Compression
8	UP04082	1	S	SCREW-Thread Form (6-19 x 1/2") Torque Specs 5-10 In/Lbs, .6-1.1 Nm.
9	UP04690	1	S	LEAD-Electrical
10	UP03885	2	S	NUT-Hex (10-24) Torque Specs 30-40 In/Lbs, 3.4-4.5 Nm.
D	UP00022	1	S	AIR FILTER KIT (Clutch) Includes items 5 & 10
5	D98760B	1	S	FILTER-AIR
10	UP03885	2	S	NUT-Hex (10-24) Torque Specs 30-40 In/Lbs, 3.4-4.5 Nm.

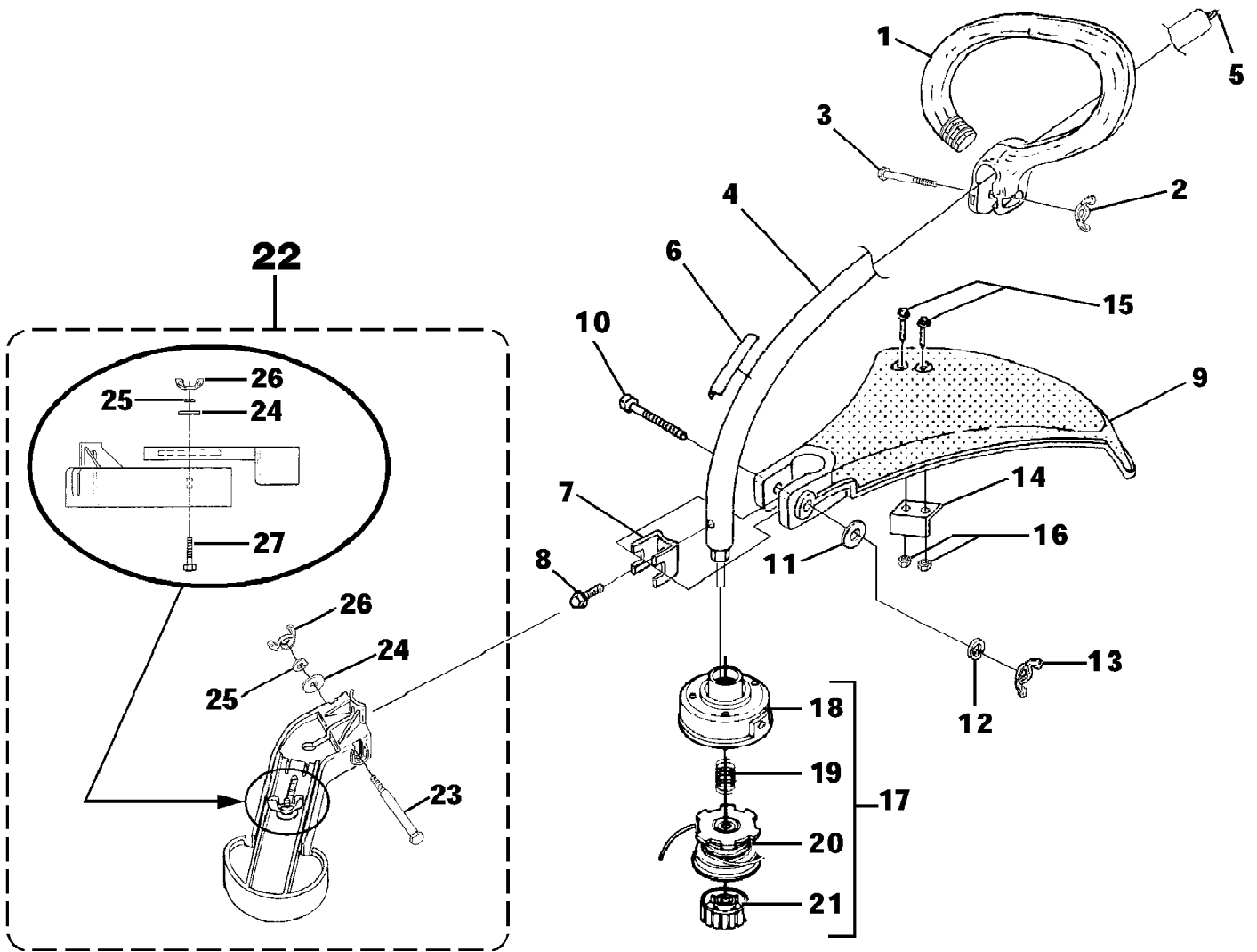

Trim N' Edge String Trimmer UT-20728  
Shaft - Spool & String - Grass Deflector

Page 12 of 12

Ref #	Part Number	Qty	S/P/F	Description
1	UP06959	1	S/P	HANDLE-Anti-Vibe Includes items 2-3
2	UP04262	1	S/P	NUT-Wing, Washer Faced (1/4-20) Torque Specs 5-25 In/Lbs, .6-2.8 Nm.
3	UP06523	1	S/P	SCREW-Cap Hex Hd.
4	UP00710	1	S/P	DRIVESHAFT HOUSING ASSY. Includes items 5-8
5	UP03031	1	S	SHAFT-Flexible
6	UP04352	1	S/P	DECAL-Warning
7	UP04137	1	/P	CLAMP
8	UP04256	1	S/P	SCREW-Sems Hex Hd. (#10-24 X 3/8") Torque Specs 15-25 In/Lbs, 1.7-2.8 Nm.
9	UP06710	1	S/P	DEFLECTOR & BLADE KIT (55 Deg.) Includes items 10-16
10	UP06523	1	S/P	SCREW-Cap Hex Hd. (10-24 X 2")
11	UP03415	1	S/P	WASHER-Flat (1/4")
12	UP03409	1	S/P	WASHER-Lock (1/4")
13	UP04262	1	S/P	NUT-Wing, Washer Faced (1/4-20) Torque Specs 5-25 In/Lbs, .6-2.8 Nm.
14	UP04119	1	/P	BLADE-Cut-Off Includes items 15-16
15	UP04159	2	S	SCREW-Mech. Hex Hd. (10-24 X 7/8")
16	UP03885	2	S	NUT-Hex (10-24) Torque Specs 30-40 In/Lbs, 3.4-4.5 Nm.
17	DA03001A	1	S/P	STRINGHEAD-Complete (.080") (UT20694, UT20697, UT20702, UT20728) Includes items 18-21
	DA04591A	1	S/P	STRINGHEAD-Complete (.095") (UT20695, UT20698, UT20707, UT20713) Includes items 18-21
18	UP06567	1	S	HOUSING & EYELET (Dual Line)
19	UP06526	1	S/P	SPRING-Compression
20	UP00145	1	S/P	SPOOL & STRING (.080")
	UP00147	1	S/P	SPOOL & STRING (.095")
21	DA98866A	1	S	RETAINER-Spool (R.H. Thread, Black)
22	UP00008	1		EDGER GUIDE KIT Includes items 23-27
23	UP04148	1	S	SCREW-Hex Hd. (1/4-20 X 2 1/2")
24	UP03415	2	S/P	WASHER-Flat (1/4")
25	UP03409	2	S/P	WASHER-Lock (1/4")
26	UP04262	2	S/P	NUT-Wing, Washer Faced (1/4-20) Torque Specs 5-25 In/Lbs, .6-2.8 Nm.
27	UP04158	1	S/P	SCREW-Hex Hd. (1/4-20 X 1")