

ST60 Electric String Trimmer UT-21512
Handle

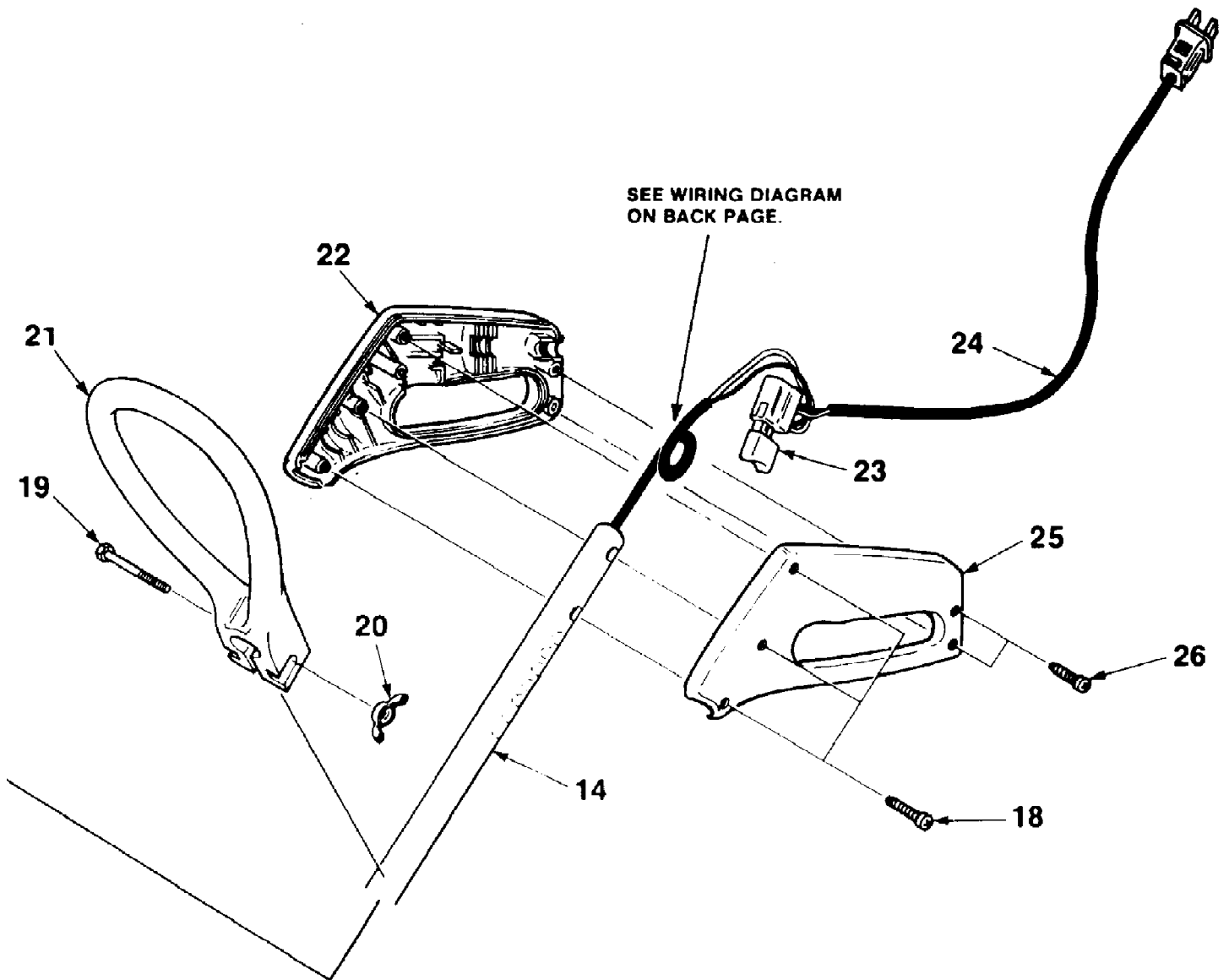

ST60 Electric String Trimmer UT-21512
Handle

Page 2 of 8

Ref #	Part Number	Qty	S/P/F	Description
	951371	1		RETAINER SPOOL
	DA95916A	1		SPOOL & STRING
	A95129	1		HEAD- String
	95121	1		MOTOR- Electric 120V (ST-40)
	95122	1		MOTOR- Electric 120V (ST-60)
	00055A	1	/P	HOUSING- Motor (left) (ST-40)
	95107A	1		HOUSING- Motor (left) (ST-60)
	96816	2		SHIM- Motor
	94065	8		SCREW- Thread forming 10-16 x 3/4
	95391	1		DECAL- Warning
	95672	1		RECTIFIER
	50729	1		CLAMP- Wire
	00054	1		HOUSING- Motor (right) (ST-40)
	95106A	1		HOUSING- Motor (right)
	95152	1		DECAL (ST-40)
	95153	1		DECAL (ST-60)
	A95111	1		CABLE- Electrical
14	95109	1		TUBING
	951321	1		DECAL- Warning
	A95127A	1		CUT- OFF- String (ST-40)
	A95115A	1		CUT- OFF- String (ST-60)
18	82408	1		SCREW- Thread forming (10 x 1")
19	80295	1	/P	SCREW- Cap hex hd. 1/4-20 x 2
20	93992	1	/P	NUT- Wing washer face
21	95110	1		HANDLE- Front
22	95102	1	/P	HANDLE- Right side
23	93013	1		SWITCH
24	95118A	1		CORD SET
25	95103	1		HANDLE- Left side
26	95198	2		SCREW- Thread forming (10-16 x 9/16)
	94305	1		Power Cord (50')
	17634	1		TOOL- Head removal

ST60 Electric String Trimmer UT-21512
Motor & String Head

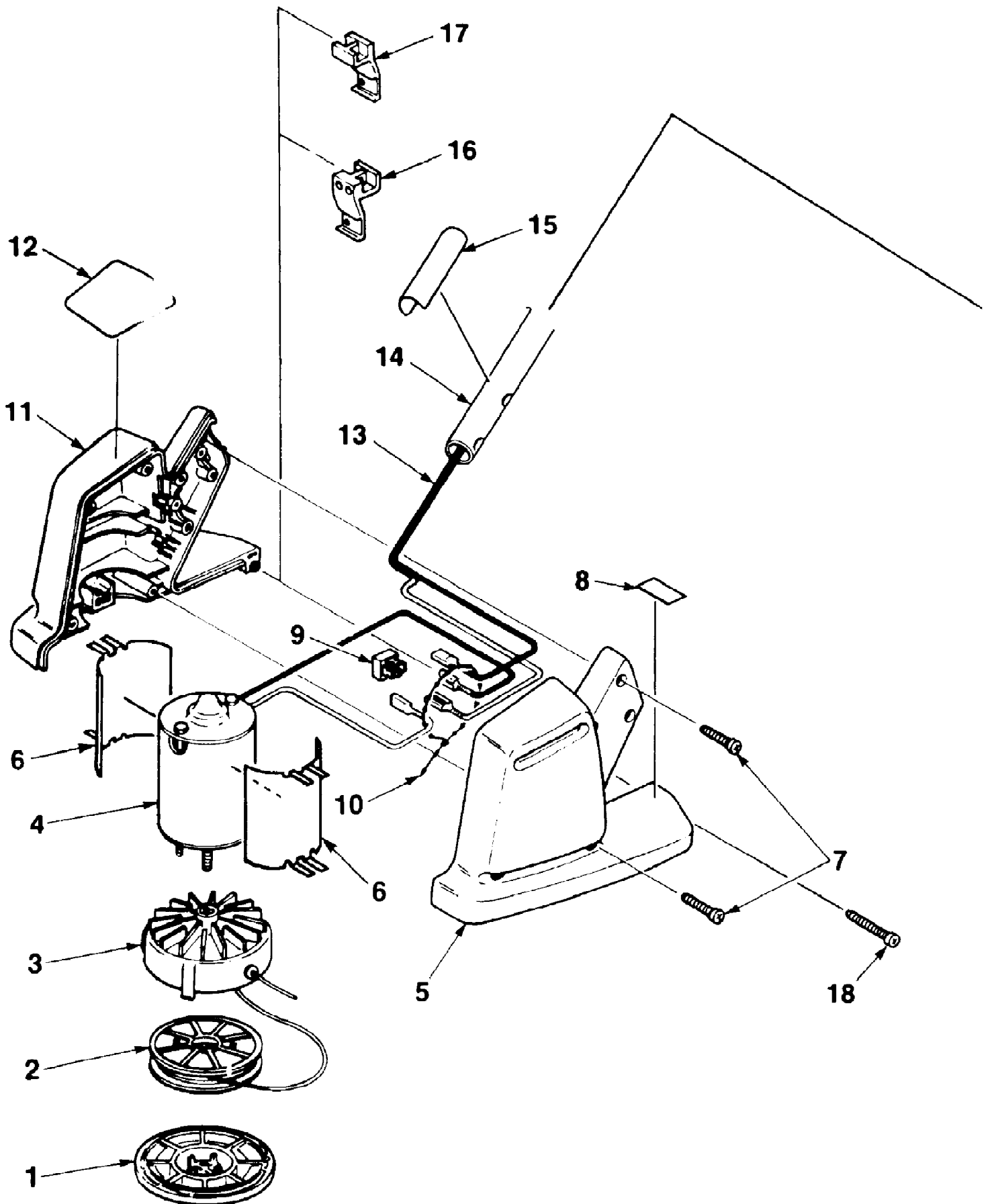

ST60 Electric String Trimmer UT-21512
Motor & String Head

Page 4 of 8

Ref #	Part Number	Qty	S/P/F	Description
1	951371	1		RETAINER SPOOL
2	DA95916A	1		SPOOL & STRING
3	A95129	1		HEAD- String
4	95121	1		MOTOR- Electric 120V (ST-40)
	95122	1		MOTOR- Electric 120V (ST-60)
5	00055A	1	/P	HOUSING- Motor (left) (ST-40)
	95107A	1		HOUSING- Motor (left) (ST-60)
6	96816	2		SHIM- Motor
7	94065	8		SCREW- Thread forming 10-16 x 3/4
8	95391	1		DECAL- Warning
9	95672	1		RECTIFIER
10	50729	1		CLAMP- Wire
11	00054	1		HOUSING- Motor (right) (ST-40)
	95106A	1		HOUSING- Motor (right)
12	95152	1		DECAL (ST-40)
	95153	1		DECAL (ST-60)
13	A95111	1		CABLE- Electrical
14	95109	1		TUBING
15	951321	1		DECAL- Warning
16	A95127A	1		CUT- OFF- String (ST-40)
17	A95115A	1		CUT- OFF- String (ST-60)
18	82408	1		SCREW- Thread forming (10 x 1")
	80295	1	/P	SCREW- Cap hex hd. 1/4-20 x 2
	93992	1	/P	NUT- Wing washer face
	95110	1		HANDLE- Front
	95102	1	/P	HANDLE- Right side
	93013	1		SWITCH
	95118A	1		CORD SET
	95103	1		HANDLE- Left side
	95198	2		SCREW- Thread forming (10-16 x 9/16)
	94305	1		Power Cord (50')
	17634	1		TOOL- Head removal

ACCESSORIES:

94305 **Power Cord (50')**

TOOLS:

17634 **TOOL- Head removal**

ST60 Electric String Trimmer UT-21512
Tools & Accessories

Page 6 of 8

Ref #	Part Number	Qty	S/P/F	Description
94305	94305	1		Power Cord (50')
17634	17634	1		TOOL- Head removal

ST60 Electric String Trimmer UT-21512
Wiring Diagram

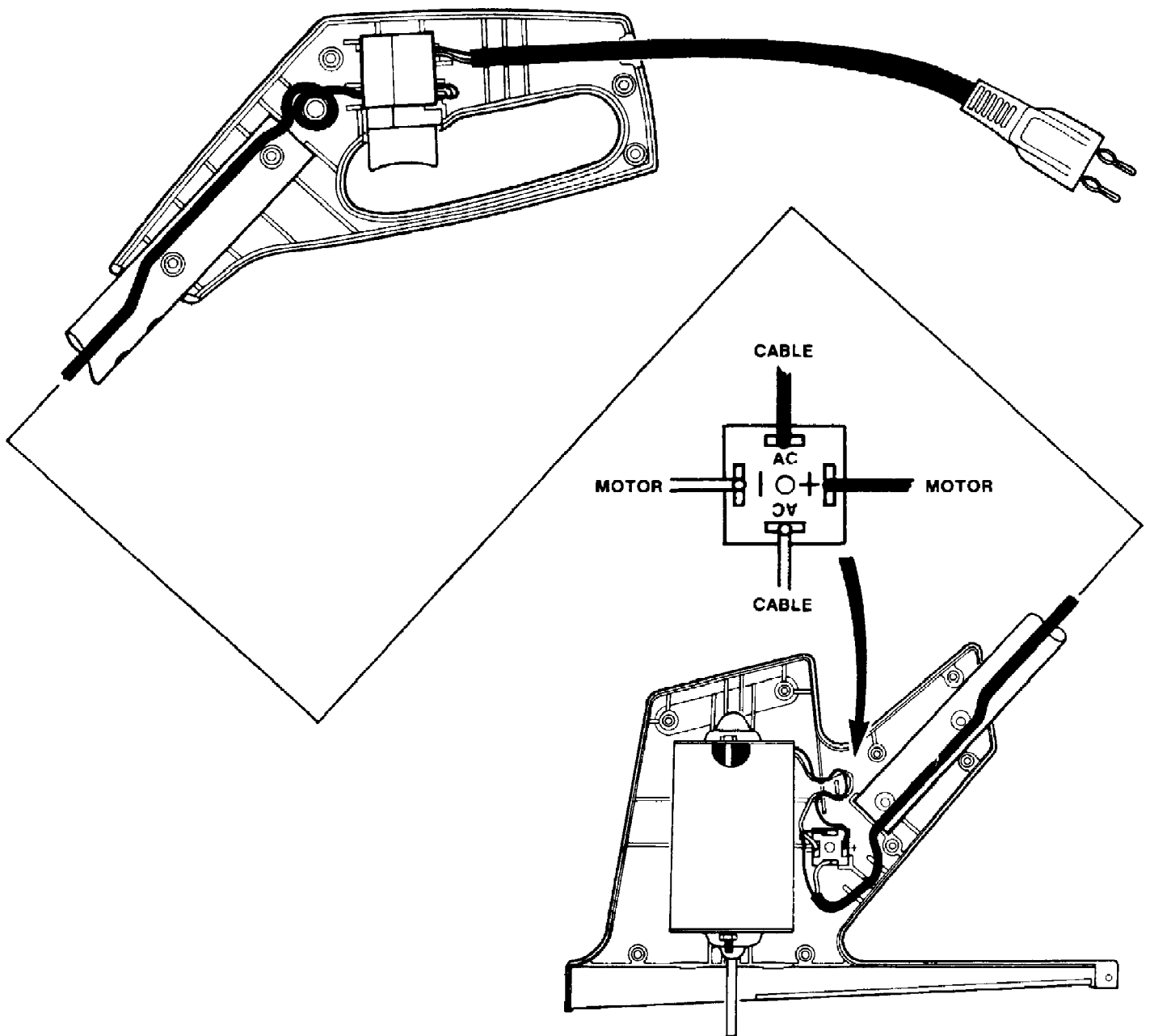

ST60 Electric String Trimmer UT-21512
Wiring Diagram

Page 8 of 8

Ref #	Part Number	Qty	S/P/F	Description
		1		Superseded by UP07217