

HLT18 String Trimmer UT-20607-A
Boom, Handles & Head

Page 2 of 12

Ref #	Part Number	Qty	S/P/F	Description
1	DA92703C	1	S	HARNESS w/Connector GST-18
2	A00101A	1		HANDLE GRIP ASSEMBLY
3	A03006	1	/P	CABLE - Throttle
4	08833	1	S	TRIGGER
5	82368	5	S	SCREW - Thread Forming (#8 X 3/4") Torque Specs. 15-25 In/Lbs, 1.7-2.8 Nm
6	A04709	1		FRONT HANDLE KIT
7	80295	1	/P	SCREW - Cap Hex Hd (1/4-20 X 2")
8	93992	1	/P	NUT - Wing (1/4-20) Torque Specs. 5-30 In/Lbs, 6-3.4 Nm
9	A04459	1	S	HOUSING - Drive Shaft
10	04458	1	S	DECAL - Starting Instructions
11	04679	1	S	DECAL - Warning
12	07928	1	S/P	CLAMP
13	98816	1	S	SHAFT - Flexible
14	88077	1	S	SCREW - Sems Hex Hd (#10 X 1/2") Torque Specs. 15-25 In/Lbs, 1.7-2.8 Nm, Red 262 Required Loctite
15a	A04705	1	S	DEFLECTOR & BLADE KIT (55 Deg)
15b	A04704	1	S	DEFLECTOR & BLADE KIT (100 Deg)
16	80295	1	/P	SCREW - Cap Hex Hd (10-24 X 2")
17	84006	1	/P	WASHER - Flat (1/4")
18	83009	1	/P	WASHER - Lock (1/4")
19	93992	1	/P	NUT - Wing (10-24) Torque Specs. 5-30 In/Lbs, 6-3.4 Nm
20	A03832	1	S	BLADE - Cut-Off
21	82531	2	/P	SCREW - Mech Hex Hd (10-24 X 7/8") Torque Specs. 15-20 In/Lbs, 1.7-2.3 Nm, Red 262 Required Loctite
22	81261	2	/P	NUT - Hex (10-24)
23a	DA03001A	1	S/P	STRINGHEAD - Complete (.080" Line) ST155, SX135, ST175 G, HLT15, GST 18
23b	DA04591A	1	S/P	STRINGHEAD - Complete (.095" Line) HLT-16, HLT-18
24	A98231A	1	S/P	HOUSING & EYELET Dual Line
25	06713	1	/P	SPRING - Compression
26a	DA98912E	1	S	SPOOL & STRING (.080" Line) ST155, SX135, ST175-G, HLT15, GST-18
26b	DA02598C	1	S	SPOOL & STRING (.095" Line) HLT 16, HLT 18
27	DA98866A	1	S	RETAINER - Spool RH Thread, Black

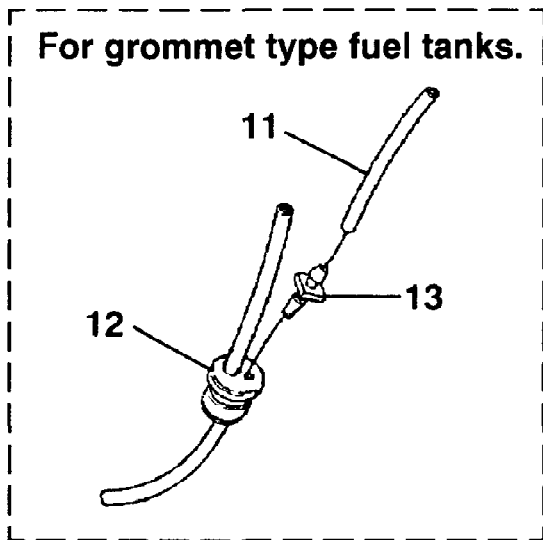
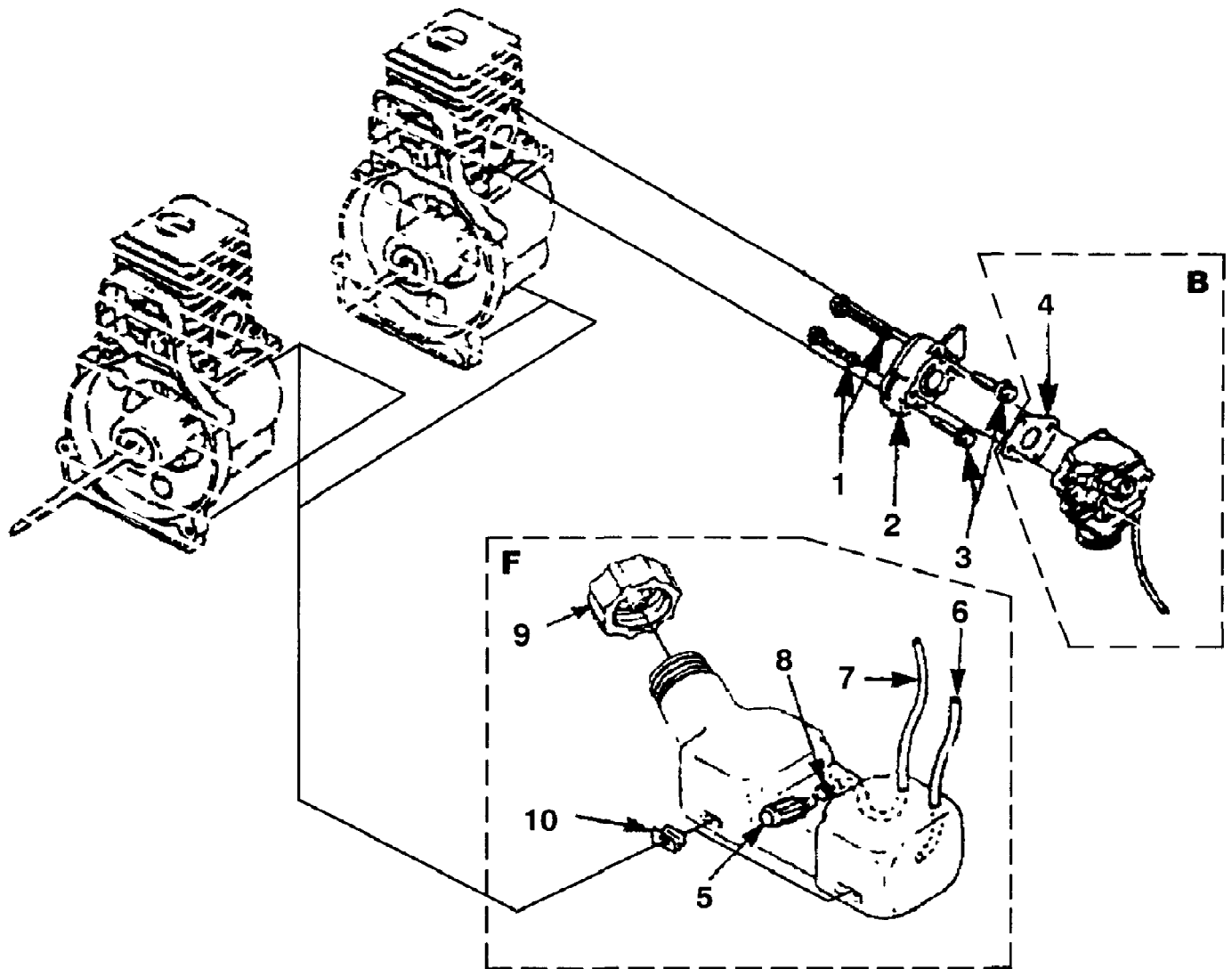

HLT18 String Trimmer UT-20607-A
Carburetor - Fuel Tank

Page 4 of 12

Ref #	Part Number	Qty	S/P/F	Description
1	04474	2	/P	SCREW - Machine (10-24 X 2-1/4") Torque Specs. 30-40 In/Lbs, 3.4-4.5 Nm
2	98768	1	S	HEAT DAM
3	825491	2	S	SCREW - Taptite (10-24 X 1") Torque Specs. 40-50 In/Lbs, 4.5-5.6 Nm, Red 262 Required Loctite
B	A04445A	1	/P	CARBURETOR KIT
4	98766A	1	S/P	GASKET - Carburetor
F	A04447C	1	S	FUEL TANK
5	49422	1	S	FILTER Fuel
6	0143932	1	S/P	TUBING - Rubber (8")
7	9477232	1	S	TUBING - Rubber (8")
8	98268	1	S/P	CLAMP - Wire
9	A00982B	1	S	FUEL CAP
10	98792	3	/P	BUMPER - Rubber
11	0143916	1	/P	TUBING - Rubber (3 X 3/4")
12	07469	1		GROMMET w/Tubing
13	02067	1	/P	FITTING - Fuel

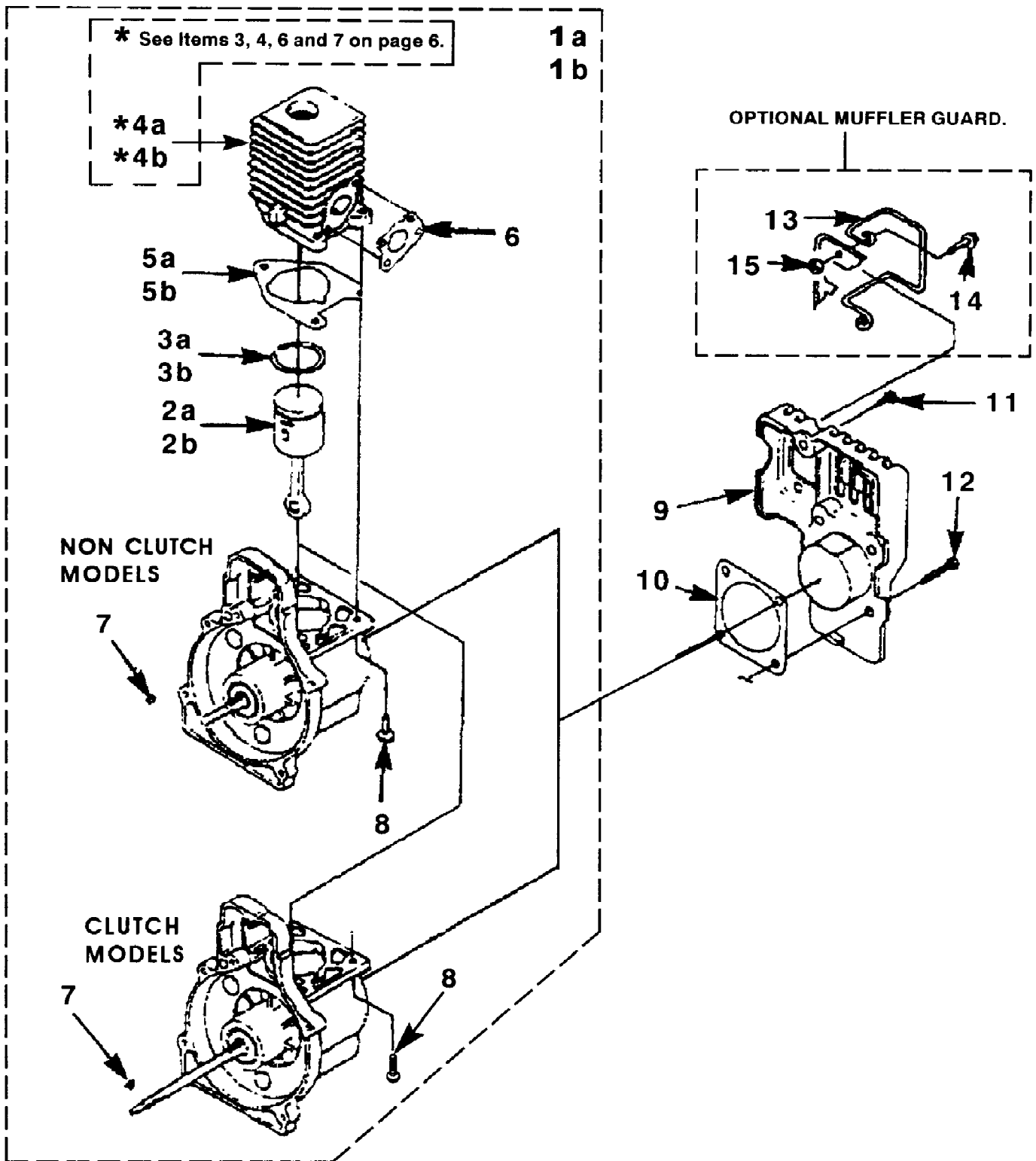

Ref #	Part Number	Qty	S/P/F	Description
1a	A07134	1	S	SHORT BLOCK (30CC Non Clutch) Short Blocks Include Items 2a-8
1b	A07135	1	S	SHORT BLOCK (30CC Clutch) Short Blocks Include Items 2a-8
2a	A03599	1	S	30CC PISTON & ROD
3a	03179	2	/P	RING - Piston
4a	A09058	1	S	30CC CYLINDER KIT
5a	04388B	1	S/P	GASKET - Cylinder
6	08840	1	/P	GASKET - Heat Dam
7	69250	1	/P	KEY - Woodruff
8	825691	3	/P	SCREW - Thread Forming (10-24 X 3/4") Torque Specs. 55-65 In/Lbs, 6.2-7.3 Nm, Red 262 Required Loctite
?1c	A09055	1	S	SHORT BLOCK (25CC Non Clutch) Short Blocks Include Items 2b-8
?1d	A09056	1	S	SHORT BLOCK (25CC Clutch) Short Blocks Include Items 2b-8
2b	A07314	1	S	25CC PISTON & ROD
3b	96935	1	S	RING - Piston
4b	A07145	1	S	25CC CYLINDER KIT
5b	04388B	1	S/P	GASKET - Cylinder
6	08840	1	/P	GASKET - Heat Dam
7	69250	1	/P	KEY - Woodruff
8	825691	3	/P	SCREW - Thread Forming (10-24 X 3/4")
9	A00858	1	/P	CRANKCASE COVER
10	98767A	1	/P	GASKET - Crankcase Cover
11	82541	2	/P	SCREW - Plastite (#10 X 1/2") Torque Specs 30-40 In/Lbs, 3.4-4.5 Nm
12	82538	4	/P	SCREW - Taptite (10-24 X 1/2") Torque Specs. 25-30 In/Lbs, 2.8-3.4 Nm, Red 262 Required Loctite
13	A00254A	1	/P	WIRE GUARD KIT
14	88049	2	/P	SCREW - Hex Sems (10-24 X 1/2") Torque Specs 40-50 In/Lbs, 4.5-5.6 Nm
15	81208	2	/P	NUT (10-24)

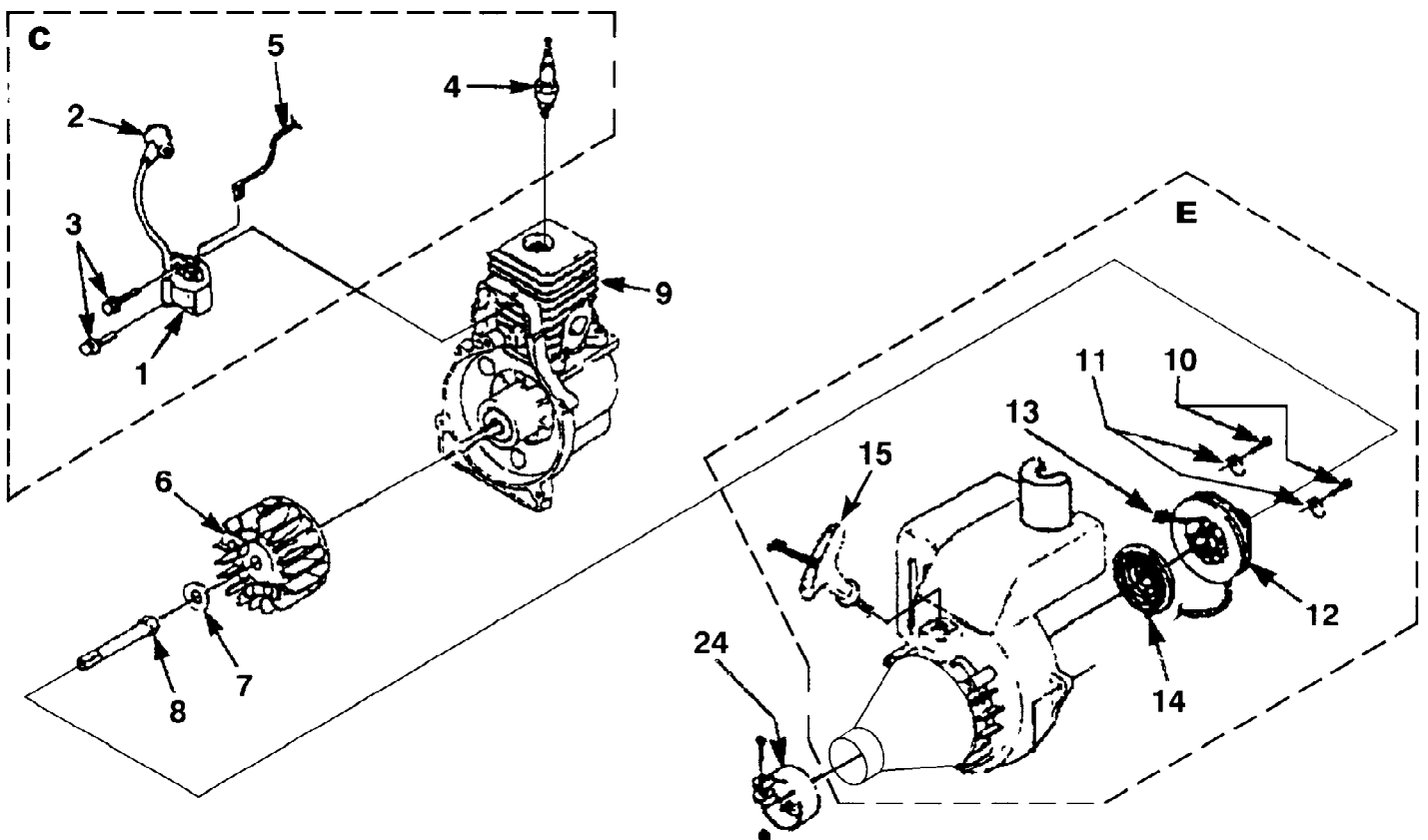

HLT18 String Trimmer UT-20607-A
Ignition - Rotor - Starter

Page 8 of 12

Ref #	Part Number	Qty	S/P/F	Description
C	A04446	1	S	IGNITION KIT
1	94711CS	1	/P	MODULE - Ignition
2	A33055	1	/P	TERMINAL & COVER
3	82540	2	/P	SCREW - Taptite (8-32 X 1") Torque Specs 30-40 In/Lbs, 3.4-4.5 Nm. Blue 242 Required Loctite
4	96169S	1	S	SPARK PLUG Torque Specs 120-180 In/Lbs, 13.6-20.3 Nm
5	A07238	1	/P	LEAD - Electrical
6	A04158S	1	S	ROTOR KIT ST-185BC, GST-BC
7	95479A	1	/P	WASHER - Flat
8	98795A	1	/P	CONNECTOR - Drive
9		1		SHORT BLOCK See "Engine Internal" illustration and parts list, items 1A, 1B.
E	A02575E	1	/P	COMPLETE STARTER ASSEMBLY
10	82541	2	/P	SCREW - Plastite (#10-1/2") Torque Specs 30-40 In/Lbs, 3.4-4.5 Nm
11	98791	2	/P	BRACKET - Retaining
12	98770A	1	/P	PULLEY - Starter
13	9789902	1	S/P	ROPE - Starter (42")
14	A98773A	1	S/P	SPRING & CONTAINER
15	02264	1	S	GRIP - Starter
?16	08469	1	S	CLAMP w/fasteners
24		1		UNKNOWN

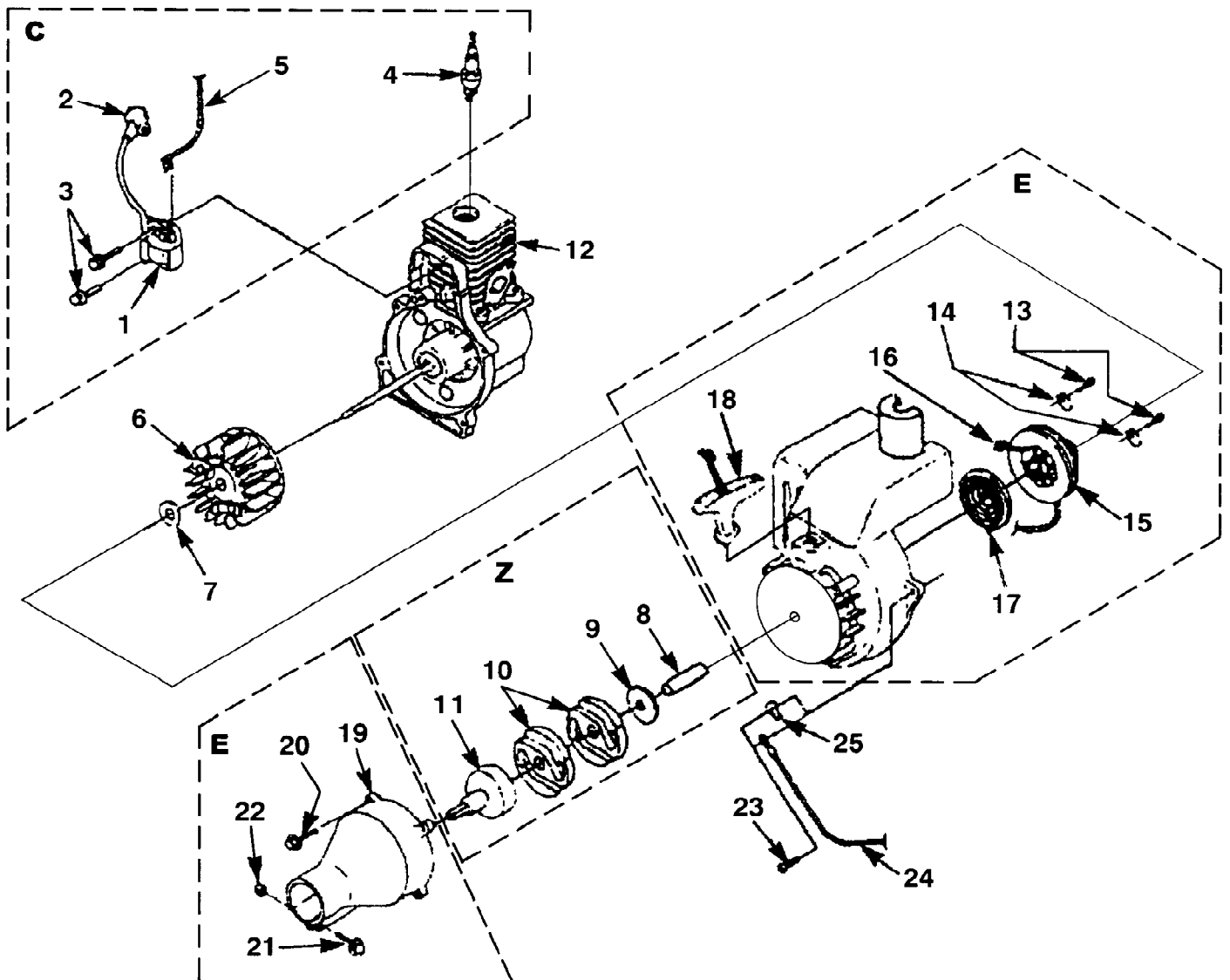

HLT18 String Trimmer UT-20607-A
Ignition - Rotor - Starter - Clutch

Page 10 of 12

Ref #	Part Number	Qty	S/P/F	Description
C	A04446	1	S	IGNITION KIT
1	94711CS	1	/P	MODULE - Ignition
2	A33055	1	/P	TERMINAL & COVER
3	82540	2	/P	SCREW - Taptite (8-32 X 1") Torque Specs. 30-40 In/Lbs, 3.4-4.5 Nm, Blue 242 Required Loctite
4	96169S	1	S	SPARK PLUG Torque Specs. 120-180 In/Lbs, 13.6-20.3 Nm
5	A00681	1		LEAD - Electrical
6	A04158S	1	S	ROTOR KIT ST-185BC, GST-BC
7	95479A	1	/P	WASHER - Flat
8	035661	1	S	SPACER Clutch Models
10	98795A	1	/P	CONNECTOR - Drive
Z	A04655	1		CLUTCH AND DRUM KIT ST-285BC, ST-385BC, HBC-18, HBC-30
9	98929A	1	S/P	WASHER - Flat
10	00242	2	/P	CLUTCH ST-185BC, GST-BC
10		3		CLUTCH ST-285BC, ST-385BC, HBC 18, HBC 30
11	A03485A	1	S	CONNECTOR & DRUM ST-285BC, ST-385BC, HBC-18, HBC-30
12		1		SHORT BLOCK See "Engine Internal" illustration and parts list, items 1A, 1B.
E	A04638C	1	/P	COMPLETE STARTER ASSEMBLY
13	82541	2	/P	SCREW - Plastite (#10-1/2") Torque Specs. 30-40 In/Lbs, 3.4-4.5 Nm
14	98791	2	/P	BRACKET - Retaining
15	98770A	1	/P	PULLEY - Starter
16	9789902	1	S/P	ROPE - Starter (42")
17	A98773A	1	S/P	SPRING & CONTAINER
18	02264	1	S	GRIP - Starter
19	A02396A	1	/P	TUBE ADAPTER
20	88052	4	/P	SCREW - Hex Hd (10-24 X 7/8") Torque Specs. 30-40 In/Lbs, 3.4-4.5 Nm
21	96624	1	/P	SCREW - Sems Hex Hd (10-24 X 1-1/8")
22	81208	1	/P	NUT (10-24) Torque Specs. 30-40 In/Lbs, 3.4-4.5 Nm
23	82538	4	/P	SCREW - Taptite (10-24 X 3/4") Torque Specs. 55-60 In/Lbs, 6.2-6.8 Nm
24	A98919A	1	S	LEAD - Ground
25	02851	1	/P	TERMINAL - Male

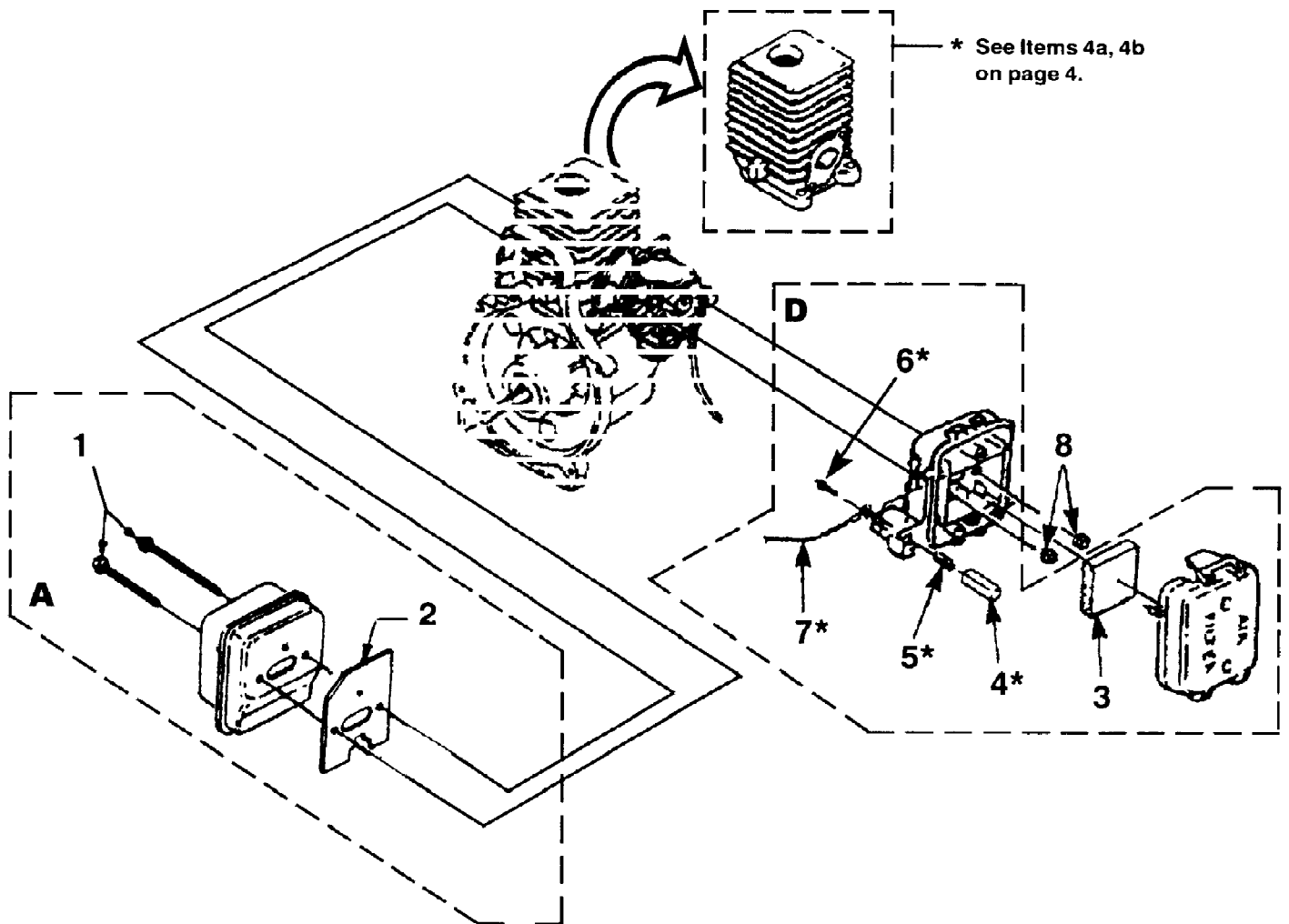

HLT18 String Trimmer UT-20607-A
Muffler - Air Cleaner

Page 12 of 12

Ref #	Part Number	Qty	S/P/F	Description
A	A04837	1	/P	MUFFLER COMPLETE
1	88060	2	S/P	SCREW - Sems Hex (10-24 X 2-1/2") Torque Specs 40-50 In/Lbs, 4.5-5.6 Nm
2	98786C	1	/P	GASKET - Muffler Also included in 25CC & 30CC Cylinder Kit; See "Engine Internal" Illustration & Parts List, Items 4a & 4b
D	A04707A	1	/P	AIR FILTER KIT
3	D98760B	1	S	FILTER - AIR
4	98769	1	/P	BUTTON - Switch Not a part of model ST-385 BC
5	95020	1	S	SPRING - Compression Not a part of model ST-385 BC
6	82513	1	/P	SCREW - Plastite (#6) Not a part of model ST-385 BC; Torque Specs 5-10 In/Lbs, 6-1.1 Nm
7	A07238	1	/P	LEAD - Electrical Not a part of model ST-385 BC
8	81208	2	/P	NUT - Hex (10-24) Torque Specs 40-50 In/Lbs, 4.5-5.6 Nm