

No
Diagram
Available

Parts List
Only

Ref #	Part Number	Qty	S/P/F	Description
	18453	1	/P	GREASE, MULTI-PURPOSE
	23488C	1		THREAD LOCKING COMPOUND
	PS24306	1	/P	MODULE AIR GAP SHIM
	A04191	1		GRASS ANTI-WRAP KIT
	98052A	1	/P	STARTER ROPE (250 Ft. Reel)
	2498203	1	S	TORX BIT (T25) (For Clutch Drums)
	1856601	1	/P	TORX BIT (T27)
	JA313164	1		IGNITION TEST SPARK PLUG
	9477299	1	/P	RUBBER TUBING (10 Ft.)
	DA03001A	1	S/P	STRINGHEAD-Complete - E-Z Line(TM) (.080 Line) (Right Hand Thread) (Black Retainer)
	9801106	1		REPLACEMENT STRING - E-Z Line(TM) (3 lb. Box) (.080" Dia.)
	DA04591A	1	S/P	STRINGHEAD-Complete - E-Z Line(TM) (.095 Line) (Right Hand Thread) (Black Retainer)
	0395904	1		REPLACEMENT STRING - E-Z Line(TM) (3 lb. Box) (.095" Dia.)
	DA09364	1	S	STRINGHEAD-Complete-Pro-Cut(TM) Fixed Line Head (.105"
	D09365	1	S	REPLACEMENT Dura Line(TM) (.105" Dia.) (Cartridges for Pro-Cut(TM) Fixed Line Head)
	D98717C	1	S/P	TRI-ARC(TM) BLADE Versa Tool(TM) Only

EasyTrim String Trimmer UT-20688-A
Carburetor - Fuel Tank

Page 4 of 12

Ref #	Part Number	Qty	S/P/F	Description
1	06900A	1	/P	GASKET-Heat Dam
2	04474	2	/P	SCREW-Machine (10-24 X 2 1/4")
3	98768A	1	/P	HEAT DAM
4	093221	2	S/P	SCREW-Sems (10-24 X 1") Torque Spec 35 - 45 in/lbs (4.0 - 5.1 Nm)
B	UP00608	1	S	CARBURETOR KIT (Non-Clutch) (Includes items 5 and 6)
	UP00654	1	/P	CARBURETOR KIT (Clutch) (Includes items 5 and 6)
5	98766A	1	S/P	GASKET-Carburetor
6	PS00236	1	S	Lever-Choke (Zama)
F	UP00020	1	S	FUEL TANK ASSY. (Includes items 7 - 14)
7	49422	1	S	FILTER-Fuel
8	0143918	1	/P	TUBING-Rubber
9	0143910	1	/P	TUBING-Rubber
10	9477213	1	/P	TUBING-Rubber
11	UP00106	1	/P	FUEL CAP
12	98792	3	/P	BUMPER-Rubber
?13	02067	1	/P	FITTING-Inline
14	98268	1	S/P	CLAMP

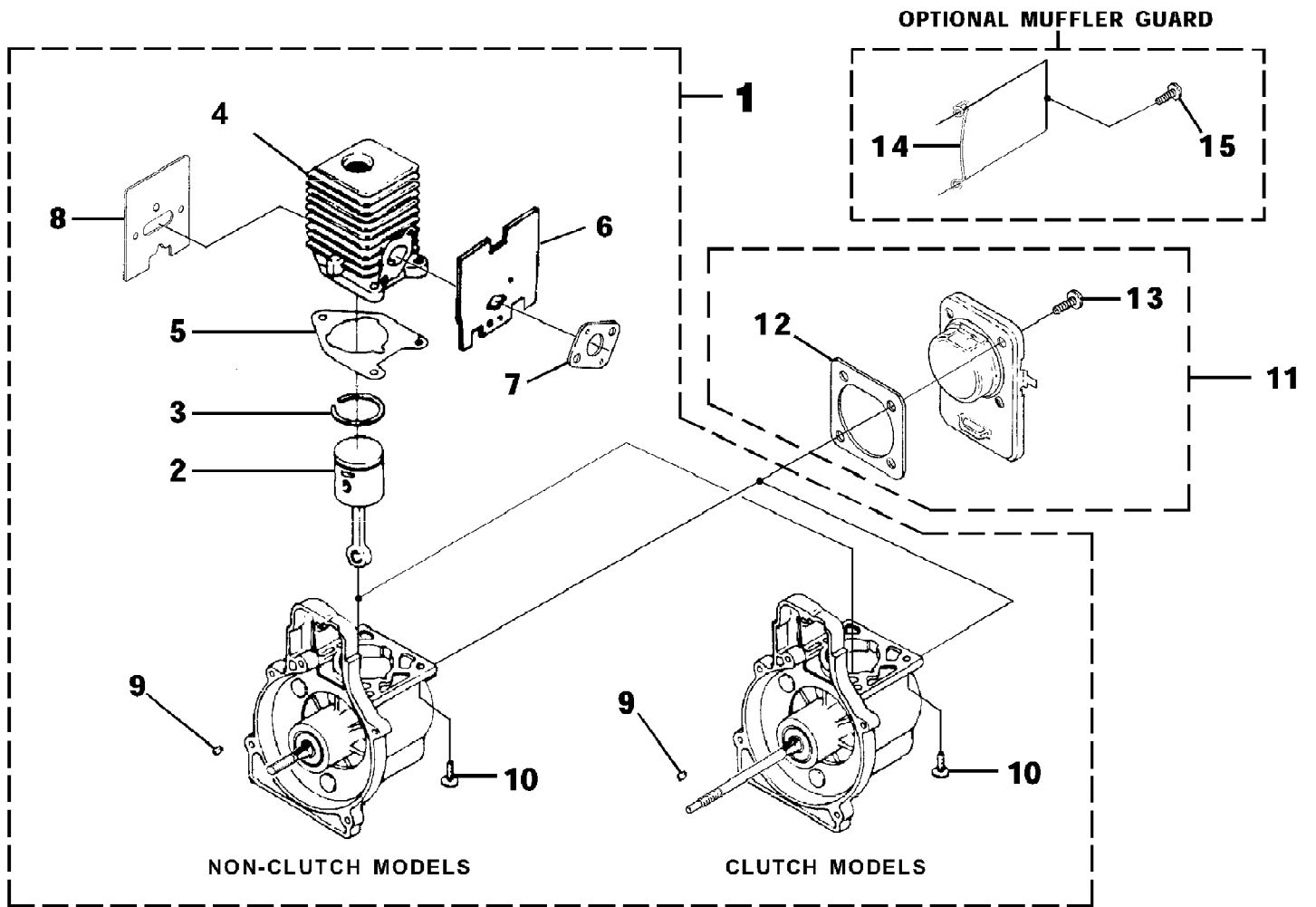

EasyTrim String Trimmer UT-20688-A
Engine Internal

Page 6 of 12

Ref #	Part Number	Qty	S/P/F	Description
1	UP00743	1	S	SHORT BLOCK (Non-Clutch) (Includes items 2 - 10)
1	UP00017	1	S	SHORT BLOCK (Clutch) (Includes items 2 - 10)
2	UP00016	1	S	PISTON & ROD ASSY. (Includes item 3)
3	PS01359	1	S/P	RING-Piston
4	UP07145	1	S/P	CYLINDER ASSY. (Includes items 5 - 8)
5	04388B	1	S/P	GASKET-Cylinder
6	06900A	1	/P	GASKET-Heat Dam
7	98766A	1	S/P	GASKET-Carburetor
8	09343	1	/P	GASKET-Muffler
9	69250	1	/P	KEY-Woodruff
10	880841	3	S	SCREW-Sems (12-24 X 3/4") Torque Spec 55 - 65 in/lbs (6.2 - 7.3 Nm)
11	UP00019	1	S	CRANKCASE COVER ASSEMBLY (Includes items 12 and 13)
12	08661	1	/P	GASKET-Crankcase Cover (Also included w/short block)
13	880851	4	S	SCREW-Sems (10-24 X 1/2") Torque Spec 35 - 45 in/lbs (4.0 - 5.1 Nm)
14	UP00027	3	S	MUFFLER GUARD (Includes item 15)
15	82541	2	/P	SCREW-Thread Forming (10-14 X 1/2") Torque Spec 5 - 20 in/lbs (.6 - 2.3 Nm)

EasyTrim String Trimmer UT-20688-A
Ignition - Rotor - Starter

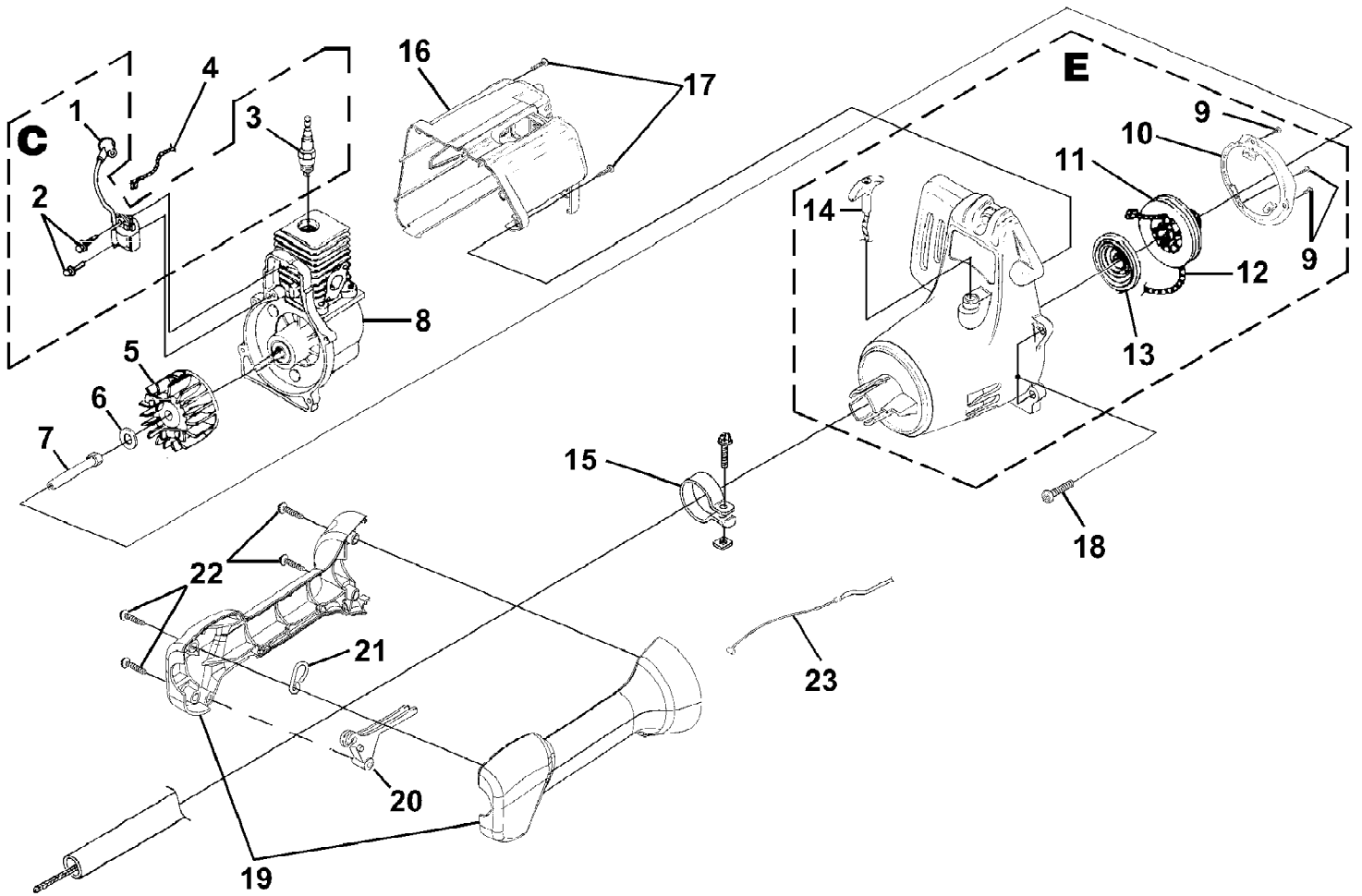

Ref #	Part Number	Qty	S/P/F	Description
C	A04446	1	S	IGNITION KIT (Includes items 1 - 3)
1	A33055	1	/P	TERMINAL & COVER
2	82540	2	/P	SCREW-Taptite (8-32 X 1") Torque Spec 30 - 40 in/lbs (3.4 - 4.5 Nm); Required Loctite Blue 242
3	96169S	1	S	SPARK PLUG Torque Spec 120 - 180 in/lbs (13.6 - 20.3 Nm)
4	A07238	1	/P	LEAD-Electrical
5	A04158S	1	S	ROTOR KIT (Includes item 6)
6	95479A	1	/P	WASHER-Flat
7	98795A	1	/P/F	CONNECTOR-Drive (.250) Torque Spec 100 - 150 in/lbs (11.3 - 16.9 Nm)
8	UP00018	1	S	SHORT BLOCK (See "Engine Internal" illustration and parts list.)
E	UP00013	1	S	COMPLETE STARTER ASSEMBLY (Includes items 9 - 14)
9	82546	3	S/P	SCREW-Taptite (8-16 X 1/2") Torque Spec 10 - 20 in/lbs (1.1 - 2.3 Nm)
10	09221	1	S	BAFFLE-Air
11	98770A	1	/P	PULLEY-Starter
12	9789902	1	S/P	ROPE-Starter (42")
13	A98773A	1	S/P	SPRING & CONTAINER
14	06598	1	S	GRIP-Starter
15	08469	1	S	CLAMP w/fasteners Torque Spec 40 - 50 in/lbs (4.5 - 5.6 Nm)
16	UP00023	1	S	HOUSING-Rear Kit (Includes item 17)
17	82537	2	/P	SCREW-Taptite (10-14 X 7/8") Torque Spec 30 - 50 in/lbs (3.4 - 5.6 Nm)
18	82538	4	/P	SCREW-Taptite (10-24 X 3/4") Torque Spec 30 - 40 in/lbs (3.4 - 4.5 Nm)
19	UP00025	1	S	CONTROL HANDLE ASSY. (Includes items 20 - 22)
20	088331	1	/P	TRIGGER-Throttle
21	07516	1	/P	HOOK-Harness
22	82537	4	/P	SCREW-Taptite (10-14 X 7/8") Torque Spec 30 - 50 in/lbs (3.4 - 5.6 Nm)
23	0883202	1	S/P	CABLE-Throttle

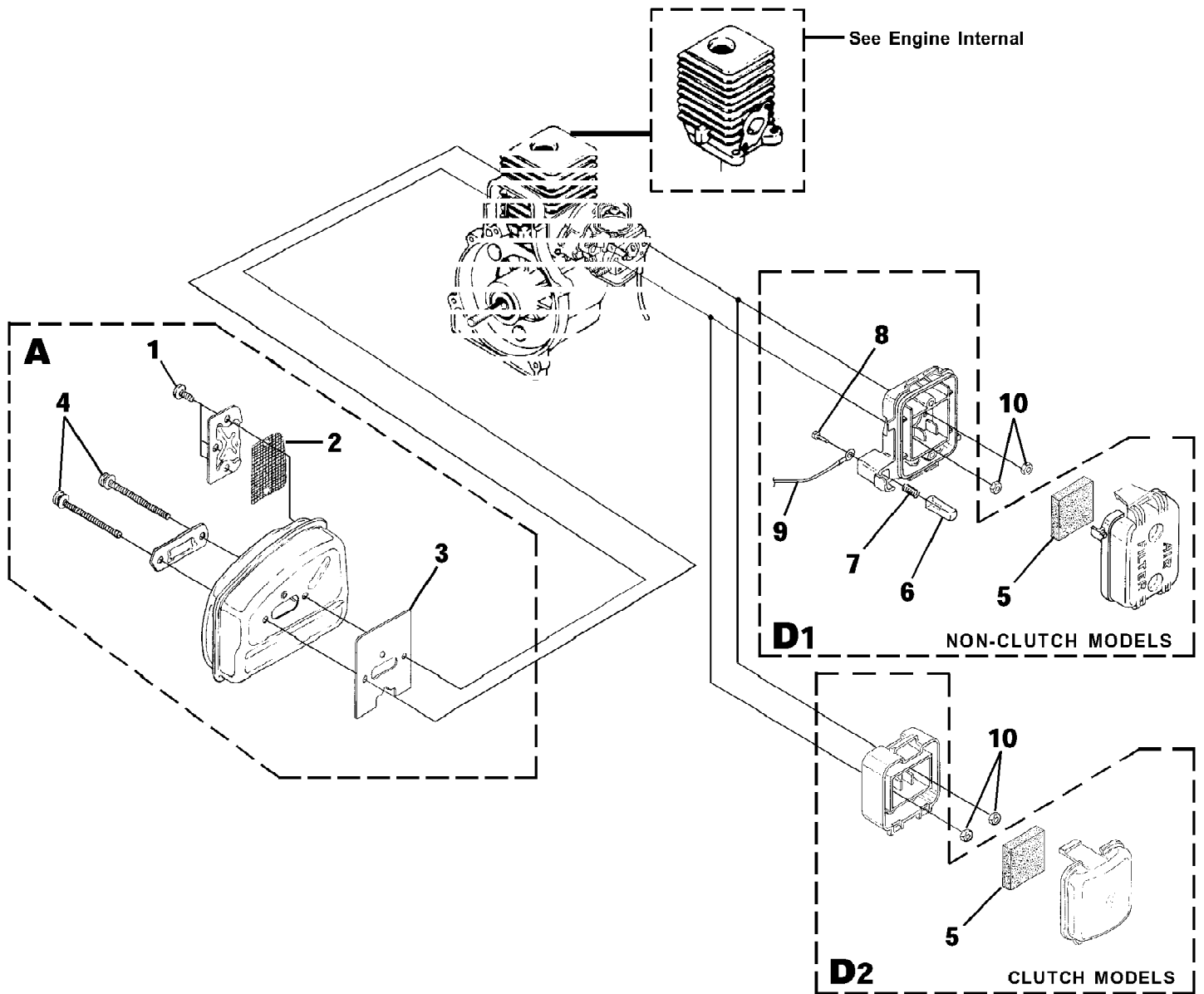

EasyTrim String Trimmer UT-20688-A
Muffler - Air Cleaner

Page 10 of 12

Ref #	Part Number	Qty	S/P/F	Description
A	A07142A	1	S	MUFFLER ASSY. (Includes items 1 - 4)
1	82600	3	/P	SCREW, Taptite- (8-32 X 3/8") Torque Spec 25 - 35 in/lbs (2.8 - 4.0 Nm)
2	06502	1	/P	SCREEN-Spark
3	09343	1	/P	GASKET-Muffler
4	88083	2	S/P	SCREW, Truss Hd. - (10-24 X 2.188) Torque Spec 50 - 60 in/lbs (5.6 - 6.8 Nm)
D1	A04707A	1	/P	AIR FILTER KIT (Non-Clutch) (Includes items 5 - 9)
5	D98760B	1	S	FILTER-Air
6	98769	1	/P	BUTTON-Switch
7	95020A	1	/P	SPRING-Compression
8	82513	1	/P	SCREW-Thread Form (6-19 x 1/2") Torque Spec 5 - 10 in/lbs (.6 - 1.1 Nm)
9	A07238	1	/P	LEAD-Electrical
10	81208	2	/P	NUT-Hex (10-24) Torque Spec 30 - 40 in/lbs (3.4 - 4.5 Nm)
D2	UP00022	1	S	AIR FILTER KIT (Clutch) (Includes items 5 and 10)
5	D98760B	1	S	FILTER-AIR
10	81208	2	/P	NUT-Hex (10-24)

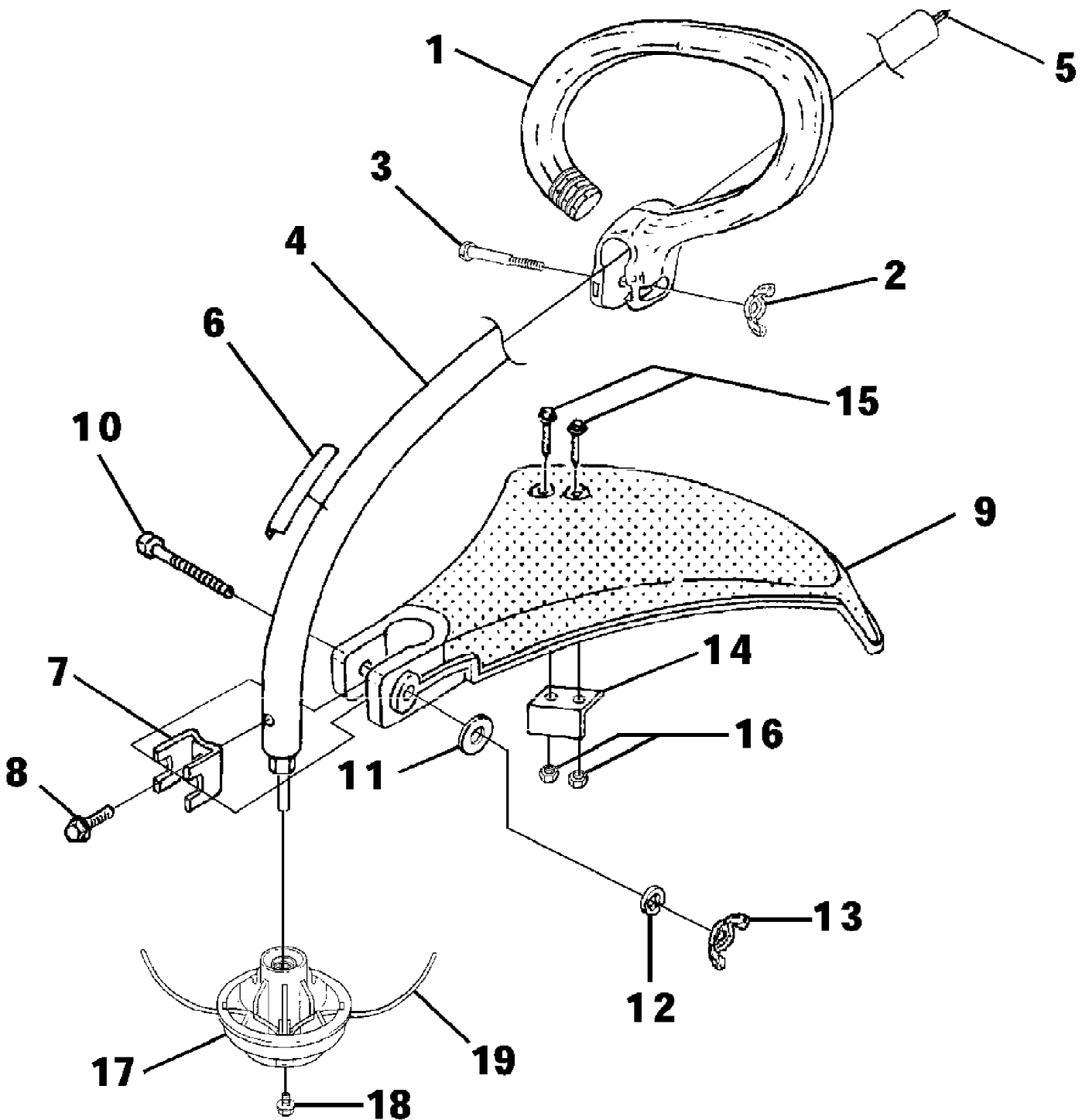

EasyTrim String Trimmer UT-20688-A
Shaft - Spool & String - Grass Deflector

Page 12 of 12

Ref #	Part Number	Qty	S/P/F	Description
1	A07136	1	S	HANDLE-Anti-Vibe (Includes items 2 and 3)
2	93992	1	/P	NUT-Wing, Washer Faced (1/4-20) Torque Spec 5 - 25 in/lbs (.6 - 2.8 Nm)
3	80295	1	/P	SCREW-Cap Hex Hd.
4	UP00710	1	S/P	DRIVESHAFT HOUSING ASSY. (Includes items 5 - 8)
5	0919401	1	S	SHAFT-Flexible (UT20678 & UT20688)
	UP03031	1	S	SHAFT-Flexible
6	PS00038	1	S	DECAL-Warning
7	07928	1	S/P	CLAMP
8	88077	1	S	SCREW-Sems Hex Hd. (#10-24 X 3/8") Torque Spec 15 - 25 in/lbs (1.7 - 2.8 Nm)
9	A04705	1	S	DEFLECTOR & BLADE KIT (55 Deg.) (Includes items 10 - 16)
10	80295	1	/P	SCREW-Cap Hex Hd. (10-24 X 2")
11	84006	1	/P	WASHER-Flat (1/4")
12	83009	1	/P	WASHER-Lock (1/4")
13	93992	1	/P	NUT-Wing, Washer Faced (1/4-20) Torque Spec 5 - 25 in/lbs (.6 - 2.8 Nm)
14	A03832	1	S	BLADE-Cut-Off (Includes items 15 and 16)
15	82531	2	/P	SCREW-Mech. Hex Hd. (10-24 X 7/8")
16	81208	2	/P	NUT-Hex (10-24) Torque Spec 30 - 40 in/lbs (3.4 - 4.5 Nm)
17	DA09364	1	S	STRINGHEAD-Pro-Cut w/line (Includes item 18)
18	PS00082	1	/P	SCREW-Stringhead Retainer Torque Spec 40 - 60 in/lbs (4.5 - 6.8 Nm)
19	D09365	1	S	LINE-Replacement