

Easy Reach String Trimmer UT-20724  
Carburetor - Fuel Tank

Page 2 of 10

Ref #	Part Number	Qty	S/P/F	Description
1	06900A	1	/P	GASKET-Heat Dam
2	04474	2	/P	SCREW-Machine (10-24 X 2 1/4")
3	98768A	1	/P	HEAT DAM
4	093221	2	S/P	SCREW-Sems (10-24 X 1") Torque Specs 35-45 In/Lbs 4.0-5.1 Nm Red 262 Loctite Required
B	UP00608	1	S	CARBURETOR KIT
5	98766A	1	S/P	GASKET-Carburetor
6	PS00236	1	S	Lever-Choke (Zama)
F	UP00020	1	S	FUEL TANK ASSY.
7	49422	1	S	FILTER-Fuel
8	0143918	1	/P	TUBING-Rubber
9	0143910	1	/P	TUBING-Rubber
10	9477213	1	/P	TUBING-Rubber
11	UP00106	1	/P	FUEL CAP
12	98792	3	/P	BUMPER-Rubber
13	02067	1	/P	FITTING-Inline
14	98268	1	S/P	CLAMP

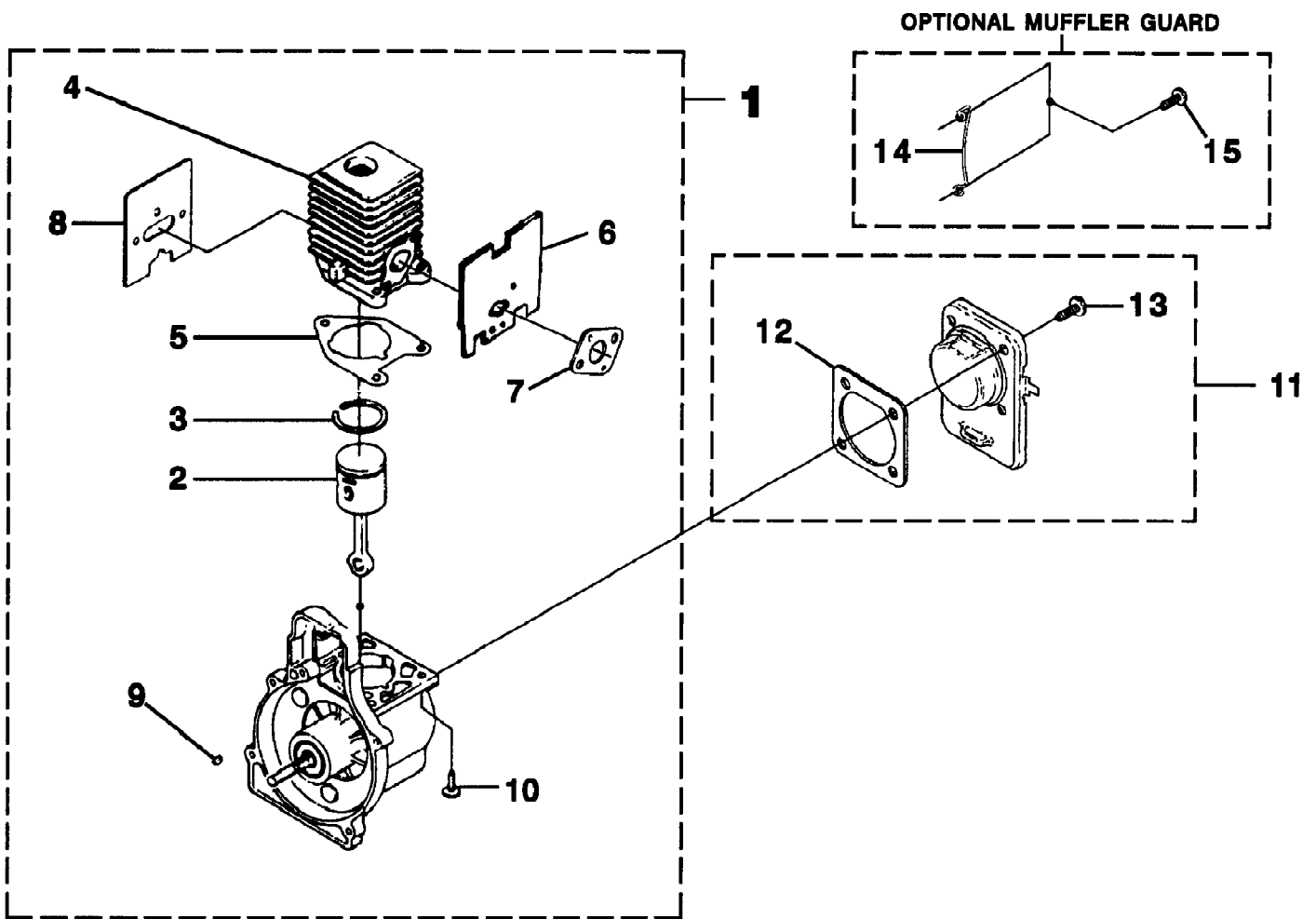

Easy Reach String Trimmer UT-20724  
Engine Internal

Page 4 of 10

Ref #	Part Number	Qty	S/P/F	Description
1	UP00743	1	S	SHORT BLOCK
2	UP00768	1	S/P	PISTON & ROD ASSY.
3	PS01359	1	S/P	RING-Piston
4	UP07145	1	S/P	CYLINDER ASSY.
5	04388B	1	S/P	GASKET-Cylinder
6	06900A	1	/P	GASKET-Heat Dam
7	98766A	1	S/P	GASKET-Carburetor
8	09343	1	/P	GASKET-Muffler
9	69250	1	/P	KEY-Woodruff
10	880841	3	S	SCREW-Sems (12-24 X 3/4") Torque Specs 55-65 In/Lbs 6.2-7.3 Nm Red 262 Loctite Required
11	UP00019	1	S	CRANKCASE COVER ASSEMBLY
12	08661	1	/P	GASKET-Crankcase Cover (Also included w/short block)
13	880851	4	S	SCREW-Sems (10-24 X 1/2") Torque Specs 35-45 In/Lbs 4.0-5.1 Nm Red 262 Loctite Required
14	UP00027	3	S	MUFFLER GUARD
15	82541	2	/P	SCREW-Thread Forming (10-14 X 1/2") Torque Specs 5-20 In/Lbs 6-2.3 Nm

Easy Reach String Trimmer UT-20724  
Ignition - Rotor - Starter

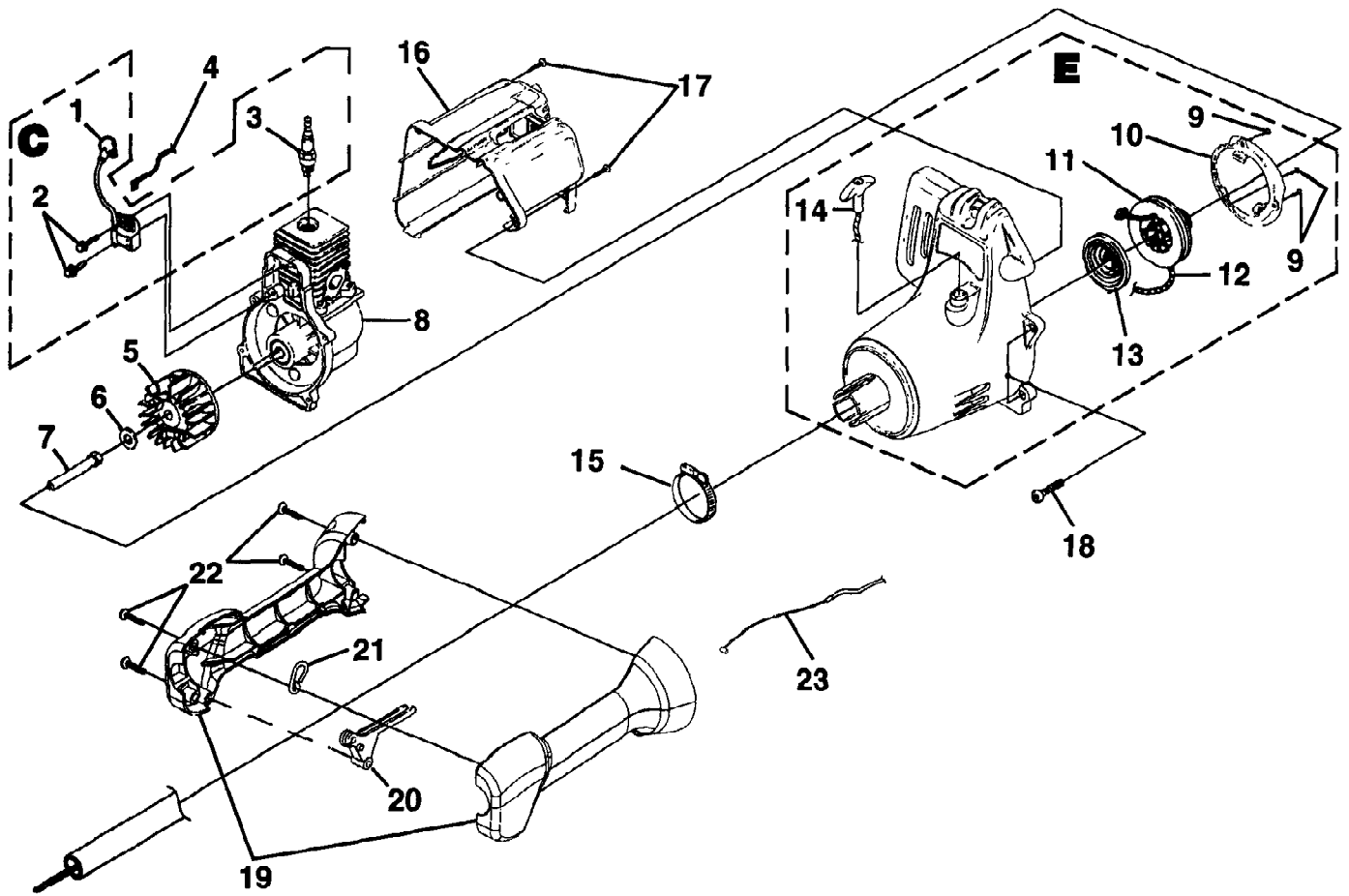

Easy Reach String Trimmer UT-20724  
Ignition - Rotor - Starter

Page 6 of 10

Ref #	Part Number	Qty	S/P/F	Description
C	A04446	1	S	IGNITION KIT
1	A33055	1	/P	TERMINAL & COVER
2	82540	2	/P	SCREW-Taptite (8-32 X 1") Torque Specs 30-40 In/Lbs, 3.4-4.5 Nm; Blue 2422 Loctite Required
3	UP00160	1	S	SPARK PLUG Torque Specs 120-180 In/Lbs, 13.6-20.3 Nm
4	A07238	1	/P	LEAD-Electrical
5	A04158S	1	S	ROTOR KIT
6	95479A	1	/P	WASHER-Flat
7	98795A	1	/P	CONNECTOR-Drive (.250) Torque Specs 100-150 In/Lbs, 11.3-16.9 Nm
8	UP00743	1	S	SHORT BLOCK (See Engine Internal)
E	UP03092	1	S/P	COMPLETE STARTER ASSEMBLY
9	82546	3	S/P	SCREW-Taptite (8-16 X 1/2") Torque Specs 10-20 In/Lbs, 1.1-2.3 Nm
10	UP03013	1	S	BAFFLE-Air
11	98770A	1	/P	PULLEY-Starter
12	9789902	1	S/P	ROPE-Starter (42")
13	A98773A	1	S/P	SPRING & CONTAINER
14	PS00179	1	/P	GRIP-Starter
15	UP03111	1	S	CLAMP Torque Specs 40-50 In/Lbs, 4.5-5.6 Nm
16	UP00023	1	S	HOUSING-Rear Kit
17	82537	2	/P	SCREW-Taptite (10-14 X 7/8") Torque Specs 30-50 In/Lbs, 3.4-5.6 Nm
18	82538	4	/P	SCREW-Taptite (10-24 X 3/4") Torque Specs 30-40 In/Lbs, 3.4-4.5 Nm
19	UP03091	1	S/P	CONTROL HANDLE ASSY.
20	088331	1	/P	TRIGGER-Throttle
21	07516	1	/P	HOOK-Harness
22	82537	4	/P	SCREW-Taptite (10-14 X 7/8") Torque Specs 30-50 In/Lbs, 3.4-5.6 Nm
23	088302	1		02 CABLE-Throttle

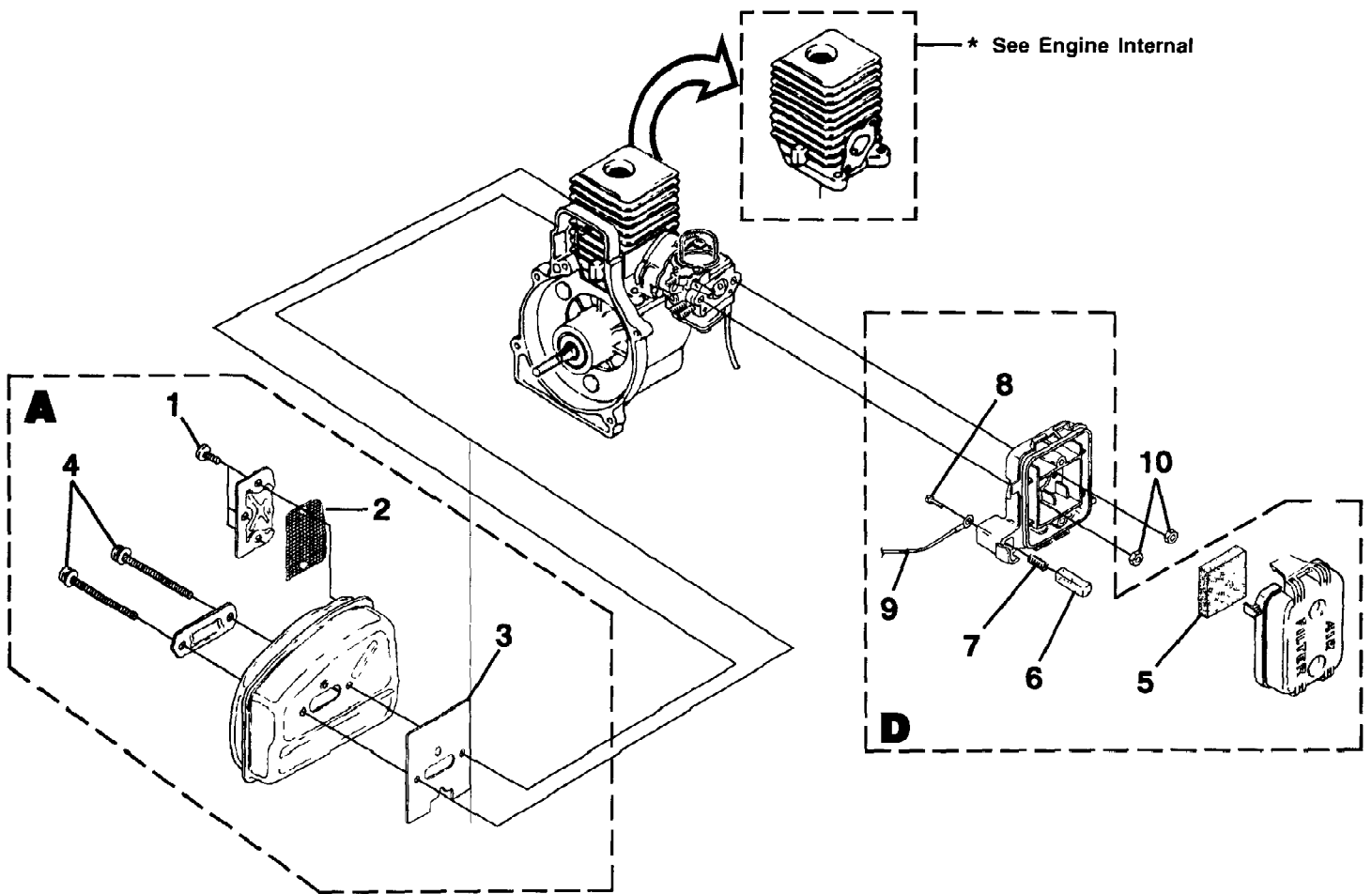

Easy Reach String Trimmer UT-20724  
Muffler - Air Cleaner

Page 8 of 10

Ref #	Part Number	Qty	S/P/F	Description
A	A07142A	1	S	MUFFLER ASSY. Torque Specs 25-35 In/Lbs 2.8-4.0 Nm
1	82600	3	/P	SCREW, Taptite - (8-32 X 3/8")
2	06502	1	/P	SCREEN-Spark
3	09343	1	/P	GASKET-Muffler
4	88083	2	S/P	SCREW, Truss Hd. - (10-24 X 2.188) Torque Specs 50-60 In/Lbs 5.6-6.8 Nm
D	A04707A	1	/P	AIR FILTER KIT
5	D98760B	1	S	FILTER-Air
6	98769	1	/P	BUTTON-Switch
7	95020A	1	/P	SPRING-Compression
8	82513	1	/P	SCREW-Thread Form (6-19 x 1/2") Torque Specs 5-10 In/Lbs .6-1.1 Nm
9	A07238	1	/P	LEAD-Electrical
10	81208	2	/P	NUT-Hex (10-24) Torque Specs 30-40 In/Lbs 3.4-4.5 Nm



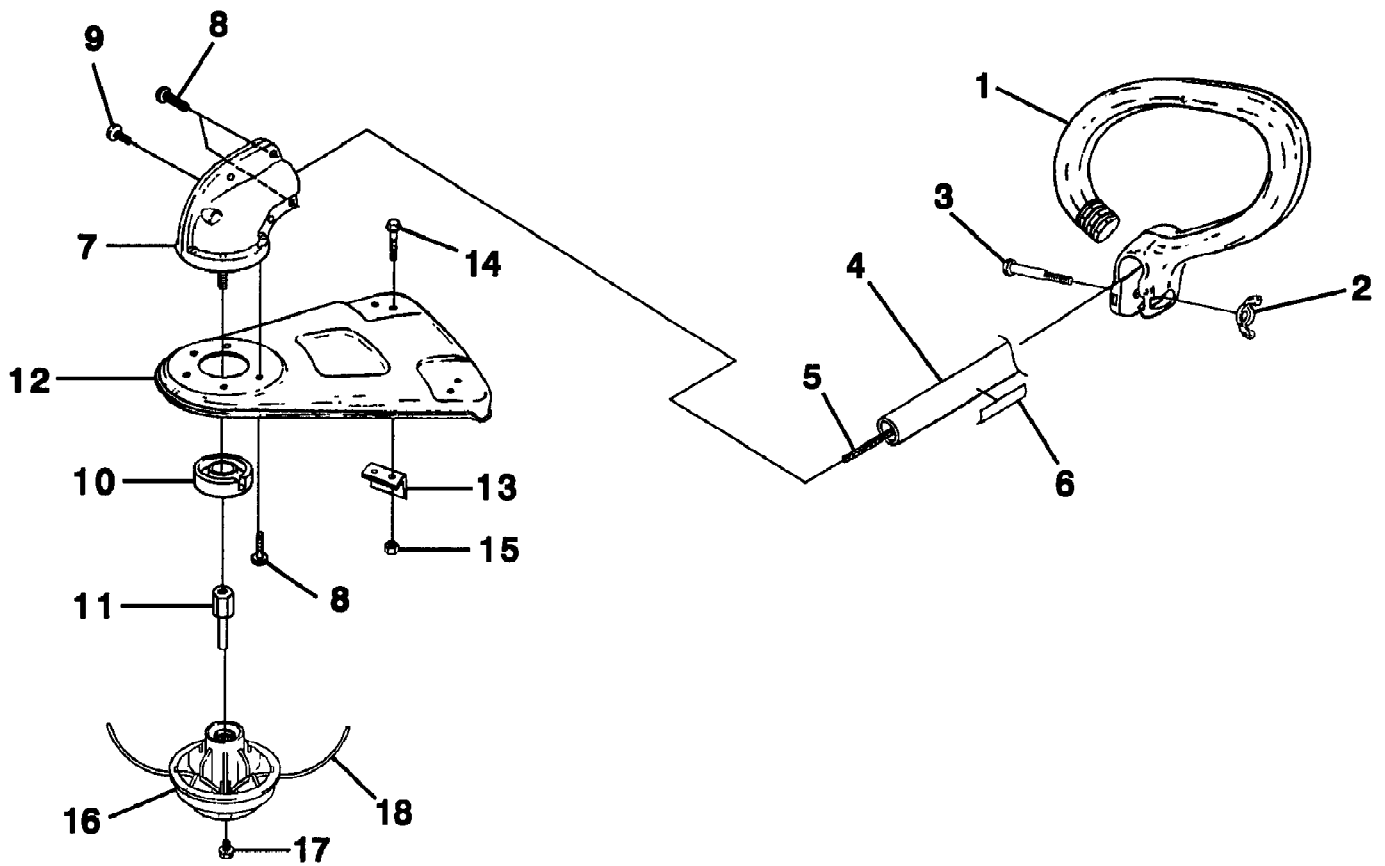

Easy Reach String Trimmer UT-20724  
Shaft - Spool & String - Grass Deflector

Page 10 of 10

Ref #	Part Number	Qty	S/P/F	Description
1	A07136	1	S	HANDLE-Anti-Vibe
2	93992	1	/P	NUT-Wing, Washer Faced (1/4-20) Torque Specs 5-25 In/Lbs .6-2.8 Nm
3	80295	1	/P	SCREW-Cap Hex Hd. (1/4-20 x 2")
4	UP00002	1	/P	DRIVESHAFT HOUSING ASSY.
5	98818	1	/P	SHAFT-Flexible
6	09353	1	/P	DECAL
7	A04836D	1	S	GEARHEAD
8	82459	5	/P	Screw, Taptite Hex Hd. (10-24 x 1/2") Torque Specs 15-20 In/Lbs 1.7-2.3 Nm
9	82298	2	S	Screw-Hex Hd. (10-24 x 5/8") Torque Specs 40-50 In/Lbs 4.5-5.6 Nm
10	04168A	1	S/P	WASHER-Flanged
11	04355	1	/P	ADAPTER-Shaft Torque Specs 100-120 In/Lbs 11.3-13.6 Nm
12	A04683A	1	/P	GRASS DEFLECTOR KIT
13	07076	1	/P	BLADE-Cut-off
14	80869	2	/P	SCREW-Mach.Hex Hd. (10-24 X 3/8")
15	81208	2	/P	NUT-Lock Hex (10-24) Torque Specs 30-40 In/Lbs 3.4-4.5 Nm
16	DA09364	1	S	STRINGHEAD-Pro-Cut w/line
17	PS00082	1	/P	SCREW-Stringhead Retainer Torque Specs 40-60 In/Lbs 4.5-6.8 Nm
18	D09365	1	S	LINE-Replacement