

B25C String Trimmer UT-20768  
Carburetor - Fuel Tank

Page 2 of 10

Ref #	Part Number	Qty	S/P/F	Description
1	UP04308	1	S/P	GASKET-Heat Dam
2	UP04131	2		SCREW-Machine (10-24 X 2 1/4")
3	UP04348	1	S	HEAT DAM
4	093221	2	S/P	SCREW-Sems (10-24 X 1") Torque Specs 35-45 In/Lbs, 4.0-5.1 Nm. Required Loctite Red 262
5	UP00608	1	S	CARBURETOR KIT (UT20768, UT20788) Includes items 6-8
6	UP03916	1	S	GASKET-Carburetor
7	UP04278	1	/P	Lever-Choke (Zama)
8	A01195A	1	S	Bulb-Primer
9	UP04742	1	S	CARBURETOR KIT (Non Clutch) Includes items 10-12
	UP05085	1	S	CARBURETOR KIT (Clutch)
10	UP03916	1	S	GASKET-Carburetor
11	UP04740	1	S	Lever-Choke
12	A01195A	1	S	Bulb-Primer
13	UP00020	1	S	FUEL TANK ASSY. Includes items 14-21
14	UP03871	1	S/P	FILTER-Fuel
15	UP04293	1	S	TUBING-Rubber
16	UP04292	1	S	TUBING-Rubber
17	UP04715	1	S	TUBING-Rubber
18	UP00106	1	/P	FUEL CAP
19	UP03501	3	S	BUMPER-Rubber
20	UP03831	1	S	FITTING-Inline
21	UP03913	1	S	CLAMP

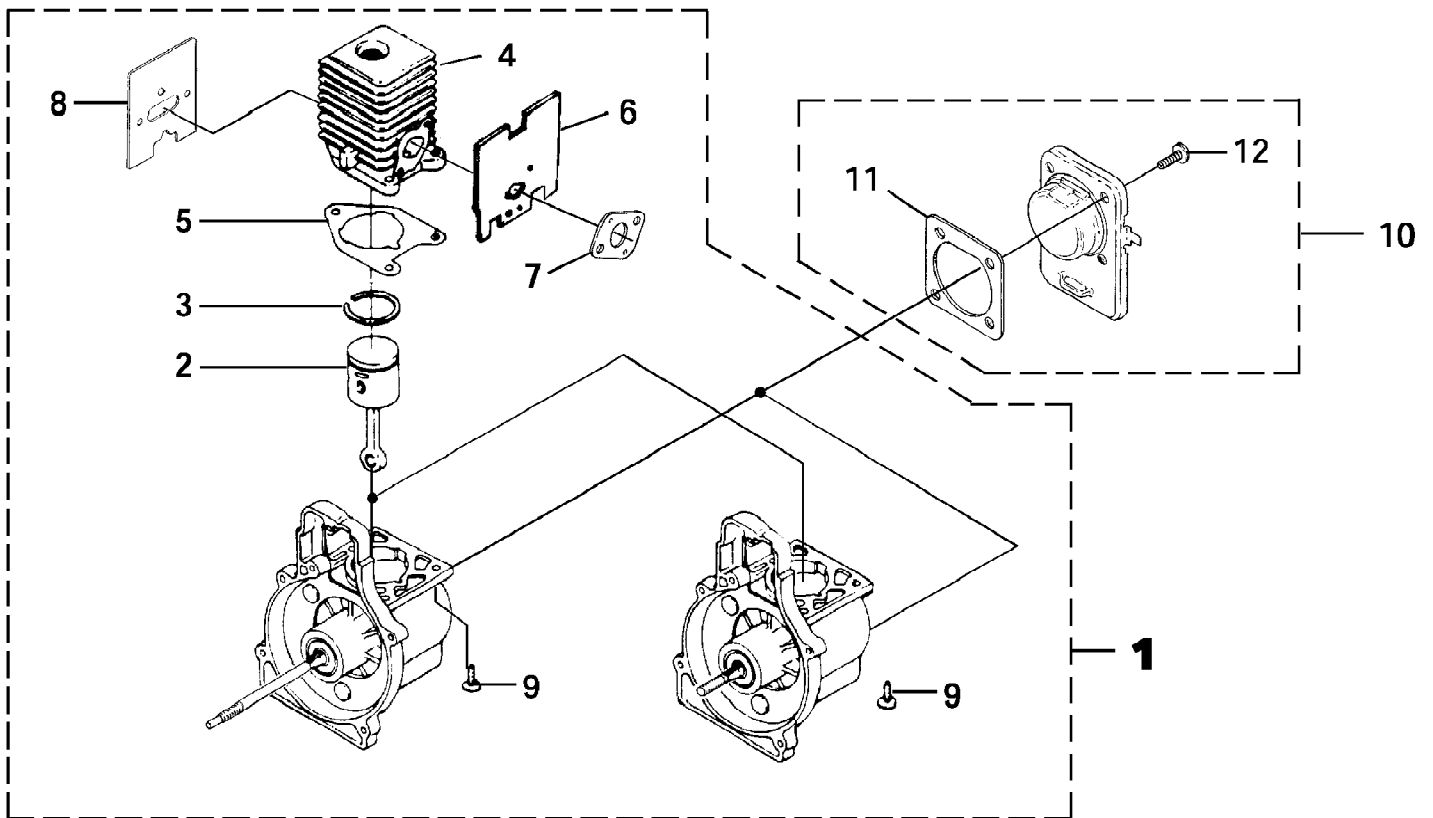

B25C String Trimmer UT-20768  
Engine Internal

Page 4 of 10

Ref #	Part Number	Qty	S/P/F	Description
1	UP03116	1	S	SHORT BLOCK (Non-Clutch) Includes items 2-9
	UP03122	1		SHORT BLOCK (Clutch)
2	UP00768	1	S/P	PISTON & ROD ASSY. Includes item 3
3	UP03838	1	S/P	RING-Piston
4	UP04136	1	S	CYLINDER ASSY. Includes item 5-8
5	UP03857	1	S/P	GASKET-Cylinder
6	UP04308	1	S/P	GASKET-Heat Dam
7	UP03916	1	S	GASKET-Carburetor
8	09343	1	/P	GASKET-Muffler
9	UP04345	3	S/P	SCREW-Sems (12-24 X 3/4") Torque Specs 55-65 In/Lbs, 6.2-7.3 Nm. Required Loctite Red 262
10	UP00019	1	S	CRANKCASE COVER ASSEMBLY Includes items 11-12
11	UP04335	1	S	GASKET-Crankcase Cover (Also included w/short block)
12	UP04295	4	S/P	SCREW-Sems (10-24 X 1/2") Torque Specs 35-45 In/Lbs, 4.0-5.1 Nm. Required Loctite Red 262

B25C String Trimmer UT-20768  
Ignition - Rotor - Starter

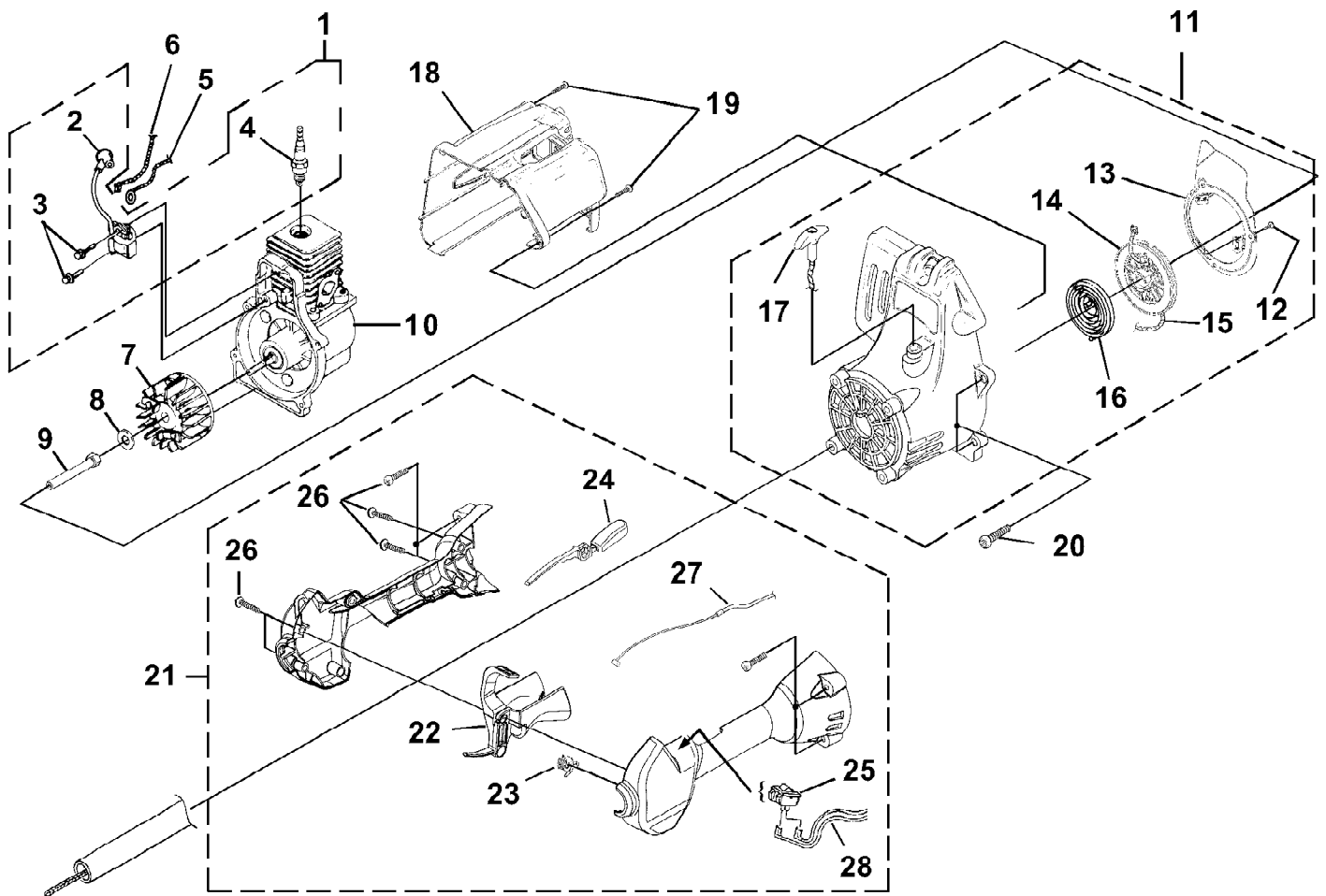

B25C String Trimmer UT-20768  
Ignition - Rotor - Starter

Page 6 of 10

Ref #	Part Number	Qty	S/P/F	Description
1	UP03858	1	/P	IGNITION KIT Includes items 2-4
2	UP03868	1	S/P	TERMINAL & COVER
3	UP03896	2	S/P	SCREW-Taptite (8-32 X 1") Torque Specs 30-40 In/Lbs, 3.4-4.5 Nm. Required Loctite Blue 242
4	UP03883	1	/P	SPARK PLUG (RDJ-7Y Torque Specs 120-180 In/Lbs, 13.6-20.3 Nm.
5	A06964	1	/P	LEAD-Electrical
6	A06963	1	/P	LEAD-Electrical
7	UP03009	1		ROTOR KIT
8	UP04241	1	S/P	WASHER-Flat
9	98795A	1	/P	CONNECTOR AND DRUM
10	UP03116	1	S	SHORT BLOCK (See "Engine Internal" illustration and parts list)
11	UP00014	1		STARTER ASSEMBLY Includes items 12-17
	UP05132	1		STARTER ASSEMBLY (B25C) Includes items 12-17
12	82543	3	/P	SCREW-Thread Form (8-16 X 1/2") Torque Specs 10-20 In/Lbs, 1.1-2.3 Nm.
13	UP03013	1	S	BAFFLE-Air
14	UP04349	1	S	PULLEY-Starter
15	UP03912	1	S	ROPE-Starter (42")
16	UP03917	1	S	SPRING & CONTAINER
17	UP04276	1	S/P	GRIP-Starter (Yellow)
18	UP03518	1		HOUSING-Rear Kit Includes item 19
19	UP03900	2	S/P	SCREW-Plastite (10-14 X 3/4") Torque Specs 30-50 In/Lbs, 3.4-5.6 Nm.
20	UP03406	4	S	SCREW-Taptite (10-24 X 3/4") Torque Specs 30-40 In/Lbs, 3.4-4.5 Nm.
21	UP03114	1	S/P	CONTROL HANDLE ASSY. Includes items 22-28
22	UP03207	1	S/P	TRIGGER-Throttle Includes item 23
23	UP03210	1	S	SPRING
24	UP03173	1	S	THROTTLE INTERLOCK
25	UP04197	1	S/P	SWITCH
26	UP04247	9	S	SCREW-Taptite (10-14 X 1") Torque Specs 30-50 In/Lbs, 3.4-5.6 Nm.
27	UP03172	1	S	CABLE-Throttle
28	UP03174	1	S	LEAD-Electrical

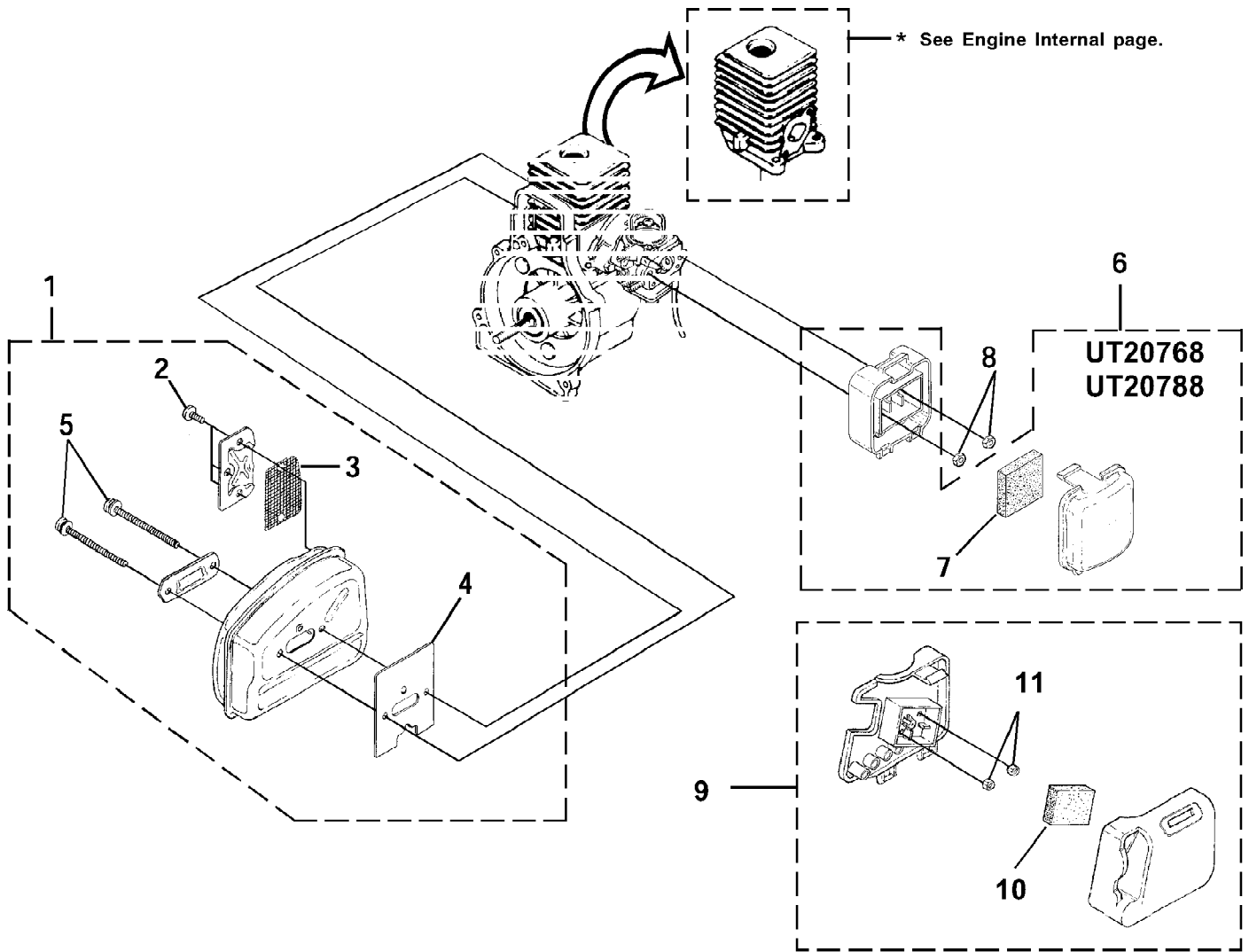

B25C String Trimmer UT-20768  
Muffler - Air Cleaner

Page 8 of 10

Ref #	Part Number	Qty	S/P/F	Description
1	UP04634	1	S/P	MUFFLER ASSEMBLY Includes items 2-5
2	82600	3	/P	SCREW, Taptite - (8-32 X 3/8") Torque Specs 25-35 In/Lbs, 2.8-4.0 Nm.
3	UP04629	1	S	SCREEN-Spark
4	09343	1	/P	GASKET-Muffler
5	88083	2	S/P	SCREW, Truss Hd. - (10-24 X 2.188) Torque Specs 50-60 In/Lbs, 5.6-6.8 Nm.
6	UP00022	1	S	AIR FILTER KIT (UT20768, UT20788) Includes items 7-8
7	D98760B	1	S	FILTER-AIR
8	UP03885	2	S	NUT-Hex (10-24) Torque Specs 30-40 In/Lbs, 3.4-4.5 Nm.
9	UP05084	1	S	AIR FILTER KIT Includes items 10-11
10	D98760B	1	S	FILTER-Air
11	UP03885	2	S	NUT-Hex (10-24) Torque Specs 30-40 In/Lbs, 3.4-4.5 Nm.



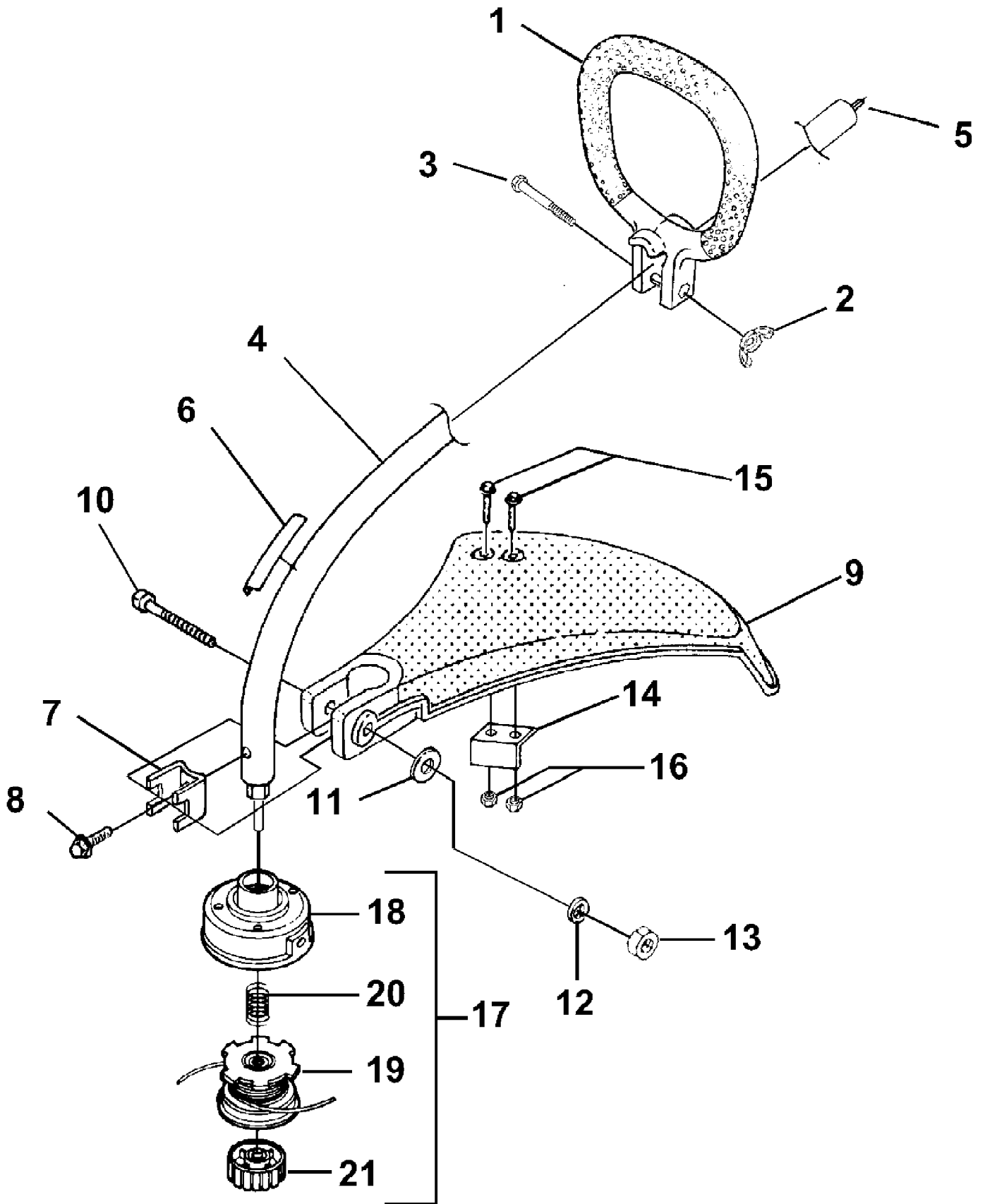

B25C String Trimmer UT-20768  
Shaft - Spool & String - Grass Deflector

Page 10 of 10

Ref #	Part Number	Qty	S/P/F	Description
1	UP03010	1	S	HANDLE ASSY.-Front Includes items 2-3
2	93992	1	/P	NUT-Wing, Washer Faced (1/4-20) Torque Specs 5-25 In/Lbs, .6-2.8 Nm.
3	80295	1	/P	SCREW-Cap Hex Hd.
4	UP04357	1	S	DRIVESHAFT HOUSING ASSY. Includes items 5-8
5	UP03031	1	S	SHAFT-Flexible
6	UP04352	1	S/P	DECAL-Warning
7	07928	1	S/P	CLAMP
8	88077	1	S	SCREW-Sems Hex Hd. (#10-24 X 3/8") Torque Specs 15-25 In/Lbs, 1.7-2.8 Nm.
9	A04705	1	S	DEFLECTOR & BLADE KIT (55 Deg.) Includes items 10-16
10	80295	1	/P	SCREW-Cap Hex Hd. (10-24 X 2")
11	UP03415	1	S/P	WASHER-Flat (1/4")
12	UP03409	1	S/P	WASHER-Lock (1/4")
13	UP03399	1	S	NUT-Hex
14	UP04119	1	/P	BLADE-Cut-Off Includes items 15-16
15	82531	2	/P	SCREW-Mech. Hex Hd. (10-24 X 7/8") Torque Specs 5-25 In/Lbs, .6-2.8 Nm.
16	UP03885	2	S	NUT-Hex (10-24) Torque Specs 30-40 In/Lbs, 3.4-4.5 Nm.
17	DA03001A	1	S/P	STRINGHEAD-Complete Includes items 18-21
18	A98231A	1	S/P	HOUSING & EYELET (Dual Line)
19	UP00145	1	S/P	SPOOL & STRING (.080" Line) Includes item 20
20	B06713	1	S/P	SPRING-Compression
21	DA98866A	1	S	RETAINER-Spool (R.H. Thread, Black)