

25cc TrimLite String Trimmer UT-20003-A
String Trimmer - Figure A

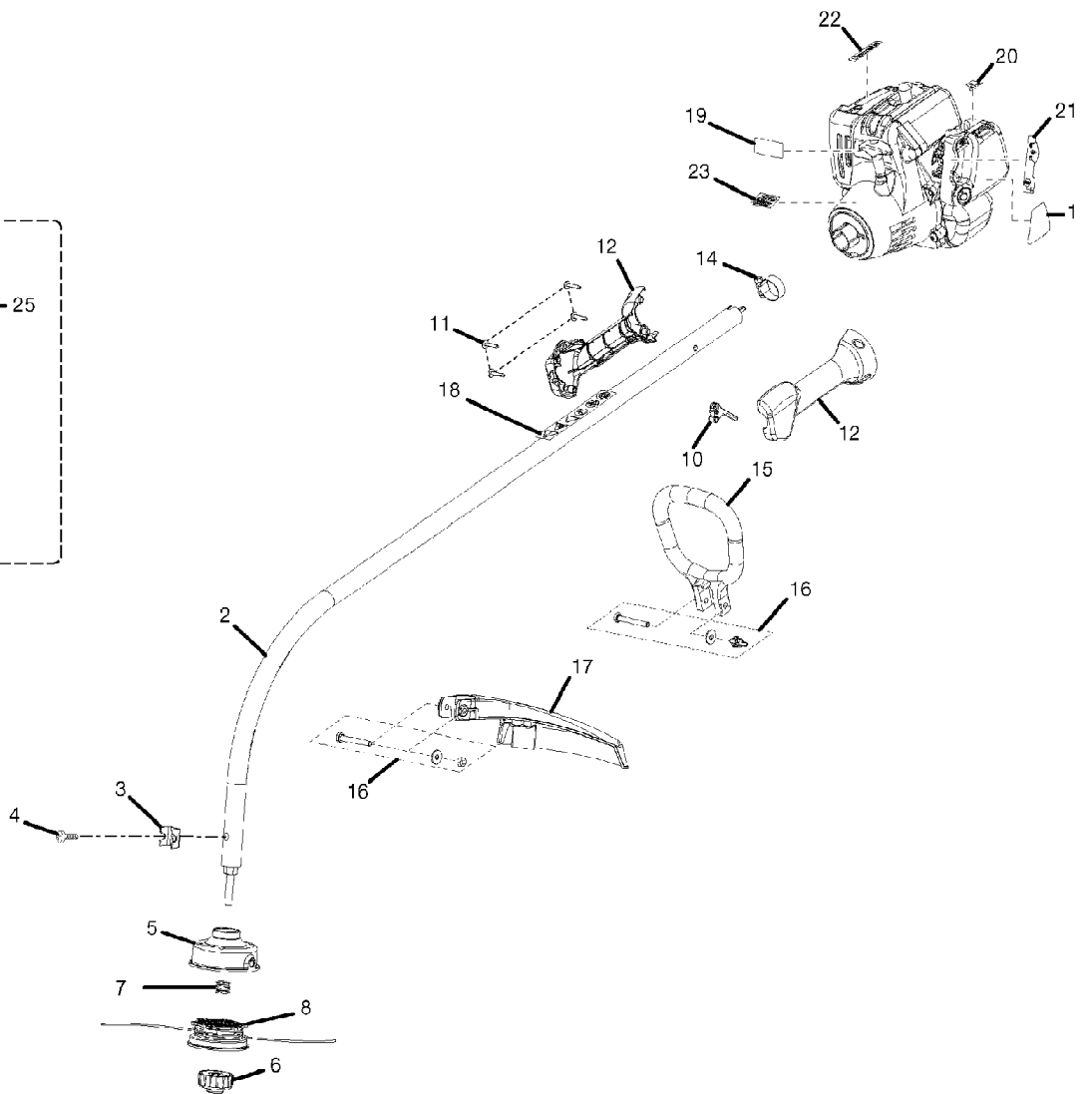
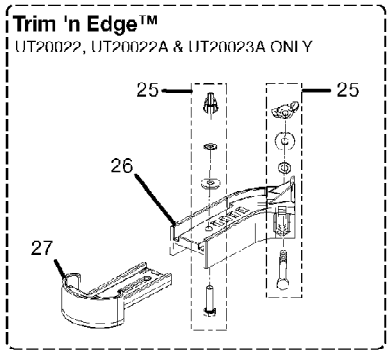

25cc TrimLite String Trimmer UT-20003-A
String Trimmer - Figure A

Page 2 of 5

Ref #	Part Number	Qty	S/P/F	Description
	984772001	1		POWER HEAD, UT20002, UT20022, UT20042
	984772003	1	S	UT20002A, UT20022A, UT20042A
	984772004	1		UT20003A, UT20023A, UT20043A
1	985591001	1		STARTING INSTRUCTION DECAL
2	985380001	1	S/P	CURVED SHAFT ASSEMBLY
3	07928	1	S/P	CLAMP
4	983823001	1	/P	SCREW (10-32 x 3/8 in.) Purchase Locally
5	A98231A	1	S/P	HOUSING AND EYELET
6	A98866A	1	S/P	SPOOL RETAINER (RH)
7	06713	1	/P	COMPRESSION SPRING
8	PA0387A	1	S	SPOOL W/LINE
10	983815001	1	S	TRIGGER
11	82537	4	/P	SCREW (10-14 x 7/8 in. TRUSS HD.) Purchase Locally
12	UP03091A	1	/P	HANDLE GRIP ASSEMBLY
14	PS01611	1	S/P	BOOM CLAMP
15	98822A	1	/P	FRONT HANDLE
16	PA00249	1	/P	FASTENER PARTS KIT
17	985623002	1	S/P	GRASS DEFLECTOR ASSEMBLY
18	984032001	1	/P	DECAL, WARNING/STARTING BOOM
19	983837001	1	/P	DECAL, TRIMLITE LOGO .
	983838001	1	/P	DECAL, TRIM-N-EDGE
	983839001	1	S	DECAL, EASY REACH
20	985595001	1	/P	DECAL, PRIMER
21	985589001	1	/P	DECAL, CHOKE
22	07184	1	S	DECAL, HOMELITE
23	983840001	1		LABEL, ZIP START (Trim 'n Edge(TM) & EZ Reach(TM) ONLY)
25	A09361	1	/P	FASTENER PARTS KIT
26	09310	1	/P	EDGER BASE
27	09311	1	/P	EDGER GUIDE

25cc TrimLite String Trimmer UT-20003-A
String Trimmer -Figure B

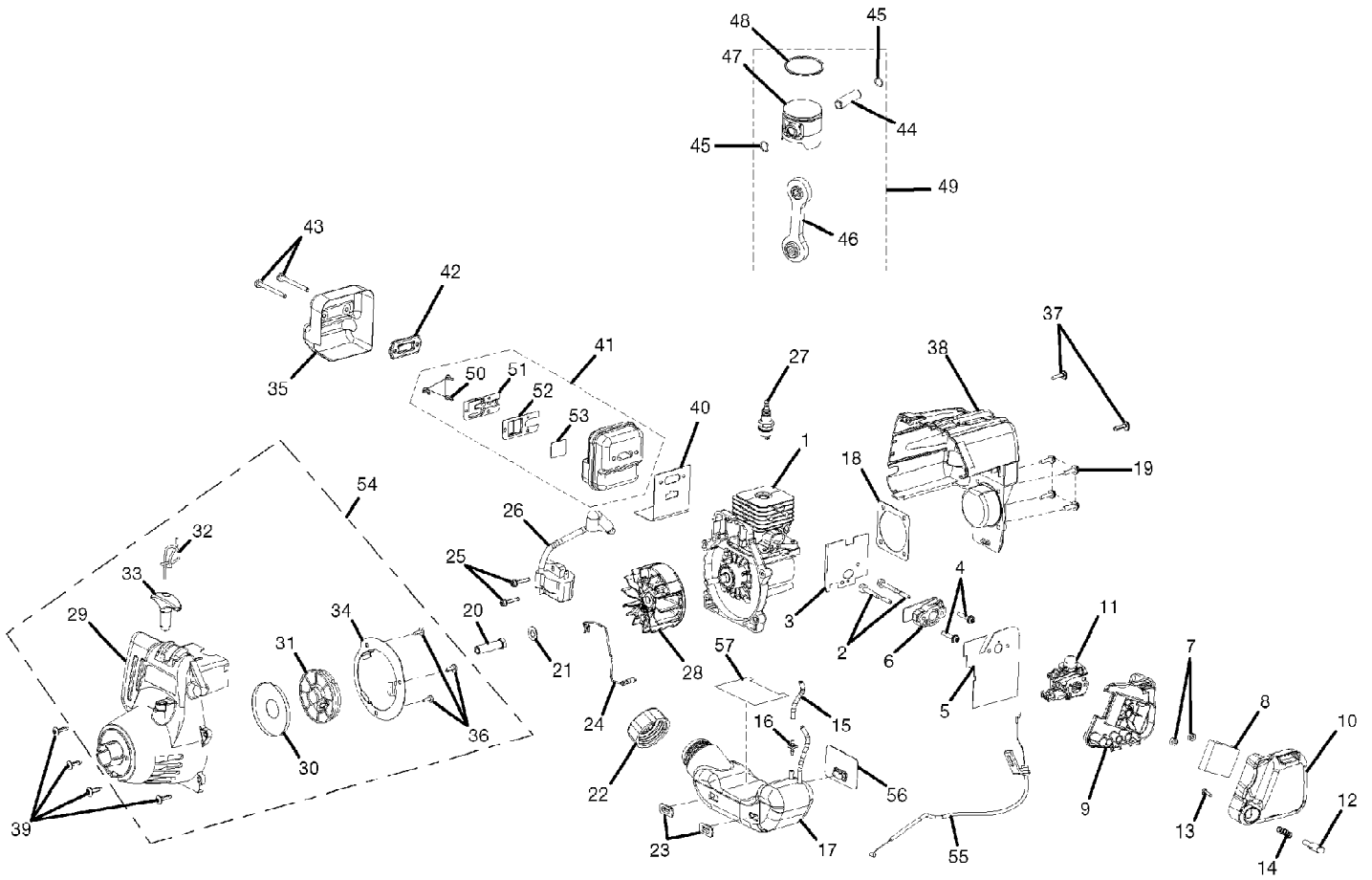

25cc TrimLite String Trimmer UT-20003-A
String Trimmer -Figure B

Page 4 of 5

Ref #	Part Number	Qty	S/P/F	Description
1	985394001	1	/P	SHORT BLOCK ASSEMBLY (984772001)
	984773001	1	/P	SHORT BLOCK ASSEMBLY (984772003 & 004)
2	04474	2	/P	CARBURETOR BOLTS
3	984762001	1	/P	INTAKE GASKET
4	093221	2	S/P	SCREW (10-24 X 1-1/16 in. PAN HD.) Purchase Locally
5	9074001	1		CARBURETOR GASKET
6	98768A	1	/P	HEAT DAM
7	81208	2	/P	LOCK NUT (10-24) Purchase Locally
8	98760	1	/P	AIR FILTER
9	PS02113	1	/P	AIR FILTER BOX
10	PS02156	1		AIR BOX COVER
11	985624001	1	S/P	CABURETOR ASSEMBLY
12	06618A	1	/P	BUTTON SWITCH
13	82513	1	/P	SCREW, (6-19 x 1/2 in. T.F.)
14	95020A	1	/P	COMPRESSION SPRING
15	0143910	1	/P	RUBBER TUBING
16	985304001	1	/P	INLINE FUEL FITTING
17	PA00116	1	S	FUEL TANK
18	06443A	1	S/P	CRANK CASE COVER GASKET
19	984812001	4	/P	SCREW (10-24 X 3/4 in. PAN HD. TORX W/LW) Purchase Locally
20	98795A	1	/P	DRIVE CONNECTOR
21	PS84065	1	S/P	FLAT WASHER
22	985210001	1	S	FUEL CAP ASSEMBLY
23	98792	3	/P	BUMPER (POWER HEAD 984772001)(POWER HEAD 984772003 & 004 QTY 2)
24	A07238	1	/P	LEAD W/TERMINALS
25	82540	2	/P	SCREW (8-32 X 1 in. THREAD FORMING) Purchase Locally
26	94711C	1	S	IGNITION MODULE (USED WITH 984772001 POWER HEAD)
	4306401	1	S	IGNITION MODULE (USED WITH 984772003 & 004, POWER HEAD)
27	PS02227	1	S/P	SPARK PLUG
28	984531001	1	S/P	ROTOR AND PAWL ASSEMBLY
29	3075303	1	S	STARTER HOUSING ASSEMBLY
30	A98773A	1	S/P	SPRING AND CONTAINER
31	98770A	1	/P	STARTER PULLEY
32	9789902	1	S/P	STARTER ROPE
33	PS06114	1	/P	STARTER GRIP
34	PS00326	1	/P	BAFFLE
35	984743001	1	/P	HEAT SHIELD (CARB. UNIT)
36	82543	3	/P	SCREW (8-16 X 1/2 in. THREAD FORMING) Purchase Locally
37	82563	2	/P	SCREW (10-14 X 3/4 in.THREAD FORMING) Purchase Locally

25cc TrimLite String Trimmer UT-20003-A
String Trimmer -Figure B

Page 5 of 5

Ref #	Part Number	Qty	S/P/F	Description
38	984740001	1	S	REAR HOUSING
39	82538	4	/P	SCREW (10-24 X 3/4 in. TRUSS HD) Purchase Locally
40	984760001	1	S	MUFFLER GASKET
41	985612001	1		NON-CATALYTIC MUFFLER ASSEMBLY (INCL KEY NO. 50 THRU 53) 984772001 & 003
	985611001	1		CATALYTIC MUFFLER ASSEMBLY (INCL KEY NO. 50 THRU 53) 984772004
42	07185	1		REINFORCEMENT PLATE (EPA UNIT)
43	88083	2	S/P	SCREW (10-24 X 2-3/16 in. TORX HD.) Purchase Locally
44	00238A	1	/P	PIN, PISTON
45	6969102	2		CLIP RING
46	PA00190	1	/P	CONNECTING ROD ASSEMBLY
47	984228001	1	/P	PISTON, 25cc
48	PS04468	1	S/P	PISTON RING
49	3081102	1		PISTON ASSEMBLY (INCLUDES KEY NO. 44-48)
50	984759001	3	/P	SCREW (6-20 x 1/4 in. PAN HD.) Purchase Locally
51	984757001	1		OUTLET TUBE
52	984755001	1		SCREEN PLATE
53	984753001	1	/P	SCREEN
54	985543001	1		COMPLETE STARTER ASSEMBLY
55	0883202	1	S/P	THROTTLE CABLE W/HANGER
56	985767001	1	S	BUMPER (USED WITH 984772003 & 004, POWER HEAD)
57	900999002	1		GASKET (USED WITH 984772004, POWER HEAD)