

TORQUE SPECIFICATIONS			
Item No.	In/Lbs	Nm	Required Loctite
12	30-40	3.4-4.5	
14	40-50	4.5-5.6	262 Red

d25mha Blower UT-08086
Carburetor And Fuel Tank

Page 2 of 12

Ref #	Part Number	Qty	S/P/F	Description
F	UP00136A	1	S/P	FUEL TANK KIT Includes Items 1-8
1	AO9116	1		FUEL CAP (1 5/8" Opening)
2	98792	3	/P	BUMPER-Rubber
3	0143922	1	/P	TUBING-Rubber (5.5")
4	PSO3380	1		FUEL FILTER
5	9477225	2	/P	TUBING-Rubber (6 1/4")
6	07332	1	S/P	Fitting, Inlet (small for 2.5mm ID fuel line)
	02067	1	/P	Fitting, Inlet (large for 3mm ID fuel line)
7	4283309	1	/P	INSULATION-Tubing
8	98268	1	S/P	CLAMP
	06443A	1	S/P	GASKET-Crankcase (Not shown)
	PS01565	4	/P	SCREW, Sems (10-24 x .56) (Not Shown)
B	UP00010A	1	/P	CARBURETOR KIT Includes Items 9-10
9	987661	1	/P	GASKET-Carburetor Also included with Cylinder Kits
10	UP03943	1	/P	LEVER-Choke (Walbro WT419,WT469)
B	UP00652	1	/P	CARBURETOR KIT Includes Items 9-10; (Back Packer(TM), BP250I, BP25175)
9	98766A	1	S/P	GASKET-Carburetor Also included with Cylinder Kits
10	UP03943	1	/P	LEVER-Choke (Walbro WT419,WT469)
11	00775A	1	S/P	GASKET-Heat Dam Also included with Cylinder Kits
12	04474	2	/P	CARB. BOLT
13	98768A	1	/P	HEAT DAM
14	093221	2	S/P	SCREW, SEMS (10-24 x 1.110)

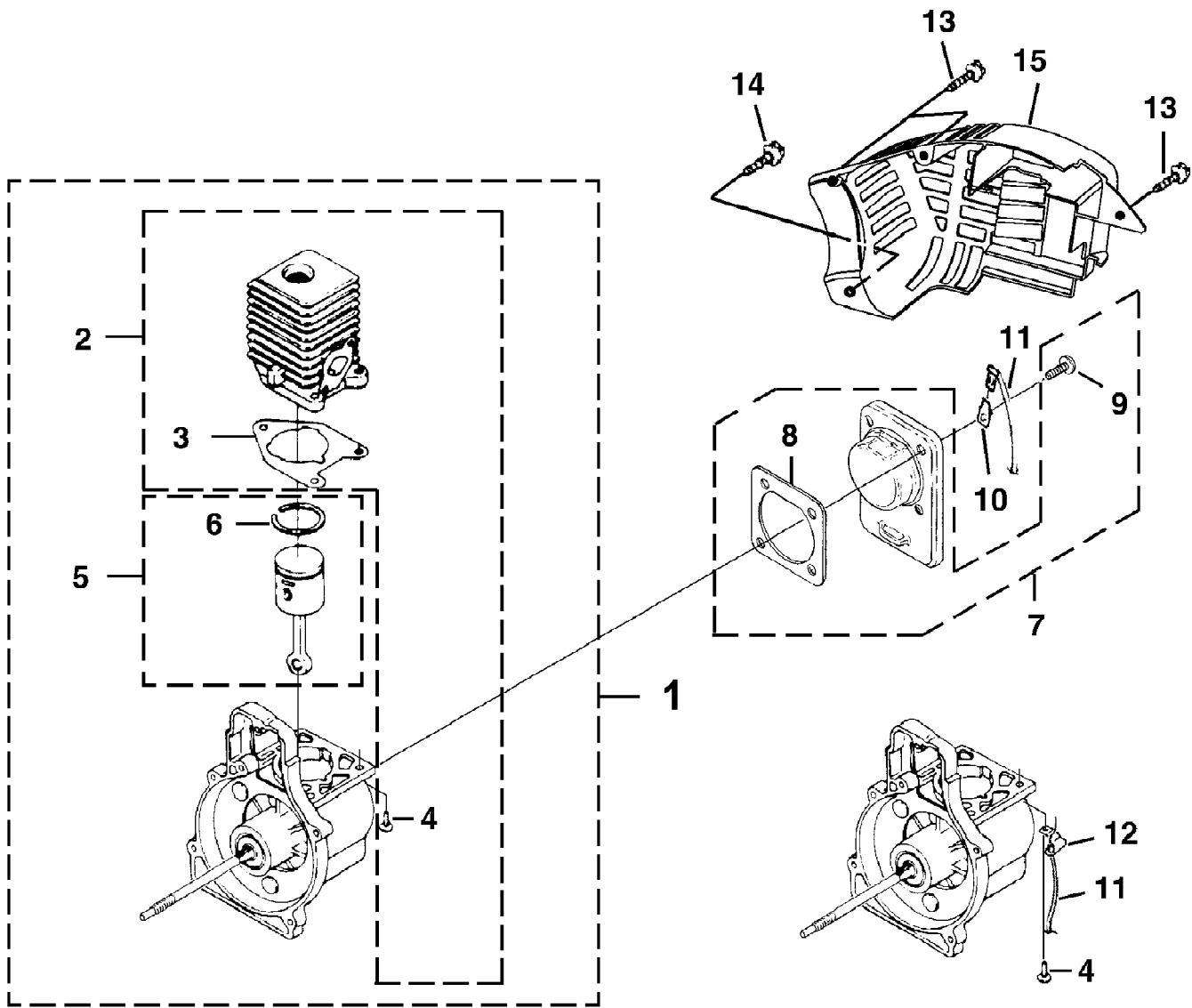

TORQUE SPECIFICATIONS			
Item No.	In/Lbs	Nm	Required Loctite
4	55-65	6.2-7.3	262 Red
9	55-65	6.2-7.3	262 Red
13	8-12	.9-1.4	
14	20-30	2.3-3.4	

d25mha Blower UT-08086
Engine Internal

Page 4 of 12

Ref #	Part Number	Qty	S/P/F	Description
1	UP03369A	1	/P	SHORT BLOCK (25cc) Includes Items 2-9
2	UP04136A	1	S/P	25 CC CYLINDER KIT Includes Items 3-4
3	04388B	1	S/P	GASKET-Cylinder
	00394B	1	/P	GASKET-Muffler (Not Shown)
	00775A	1	S/P	GASKET-Heat Dam (Not Shown)
4	PS02807	3	/P	SCREW, SEMS (12-24 x 3/4)
5	984544001	1	/P	25 CC PISTON & ROD Includes Item 6
6	PS01359	1	S/P	RING-Piston
7	PS02130	1	/P	CRANKCASE COVER-Stamped Steel Includes items 8-9
8	06443A	1	S/P	GASKET-Crankcase Also included with Cylinder Kits.
9	PS01565	4	/P	SCREW, SEMS (10-24 x .56)
10	02851	1	/P	TAB-Male
11	PA00666	1	S/P	CABLE-Throttle w/Ignition Leads (Back Packer(TM), BP250I, BP25175)
12	A01767	1	/P	CABLE BRACKET (Back Packer(TM), BP250I, BP25175)
13	82376	3	/P	SCREW-Thread Form. (#8 X 1/2")
14	82563	1	/P	SCREW-Thread Form. (#10 X 3/4")
15	UP06522A	1	/P	SHROUD

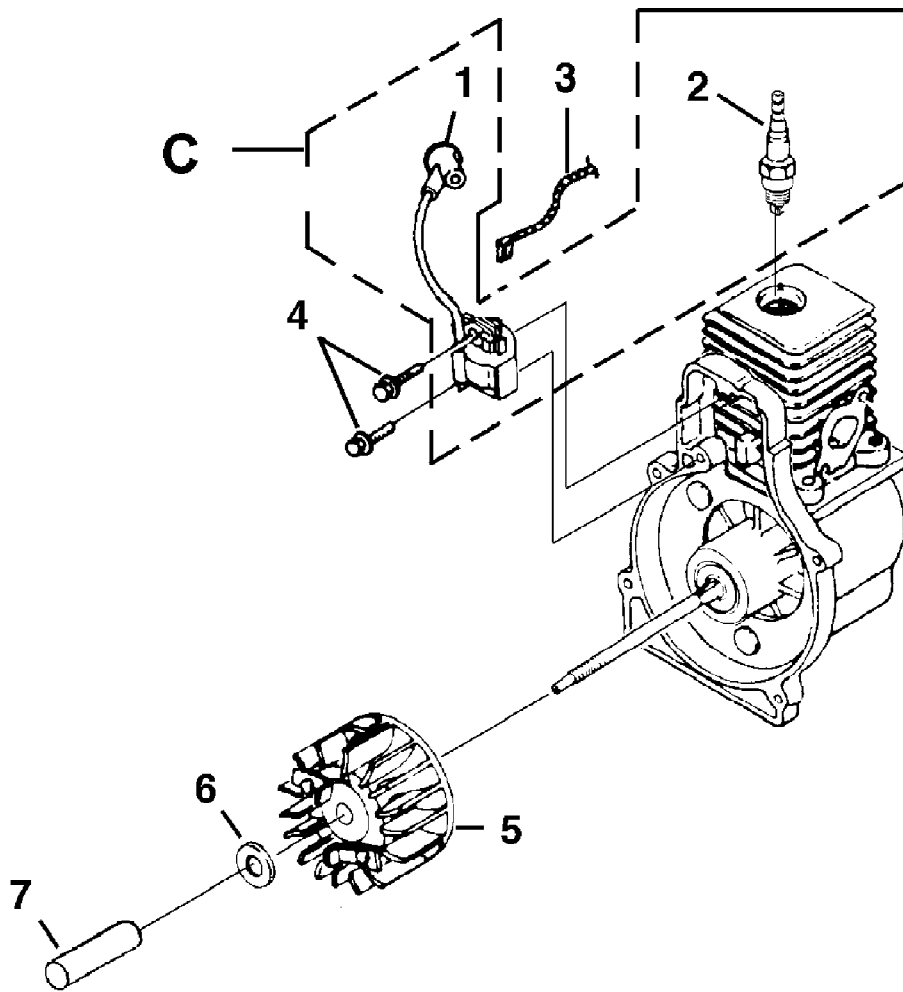

TORQUE SPECIFICATIONS			
Item No.	In/Lbs	Nm	Required Loctite
2	120-180	13.6-20.3	
4	30-40	3.4-4.5	242 Blue

d25mha Blower UT-08086
Ignition With Rotor

Page 6 of 12

Ref #	Part Number	Qty	S/P/F	Description
C	UP06784	1	/P	IGNITION KIT w/ Module Includes items 1-2
1	UP03868	1	S/P	TERMINAL-Hi-Tension
2	PSO2227	1		SPARK PLUG (RDJ-7Y)
3	PA00666	1	S/P	CABLE-Throttle w/Ignition Leads (Back Packer(TM), BP250I, BP25175)
4	82540	2	/P	SCREW-Thread Form. (8-32 x 1")
5	984531001	1	S/P	ROTOR & STARTER PAWLS
6	95479A	1	/P	WASHER-Flat
7	PSO3566	1		SPACER-Fan

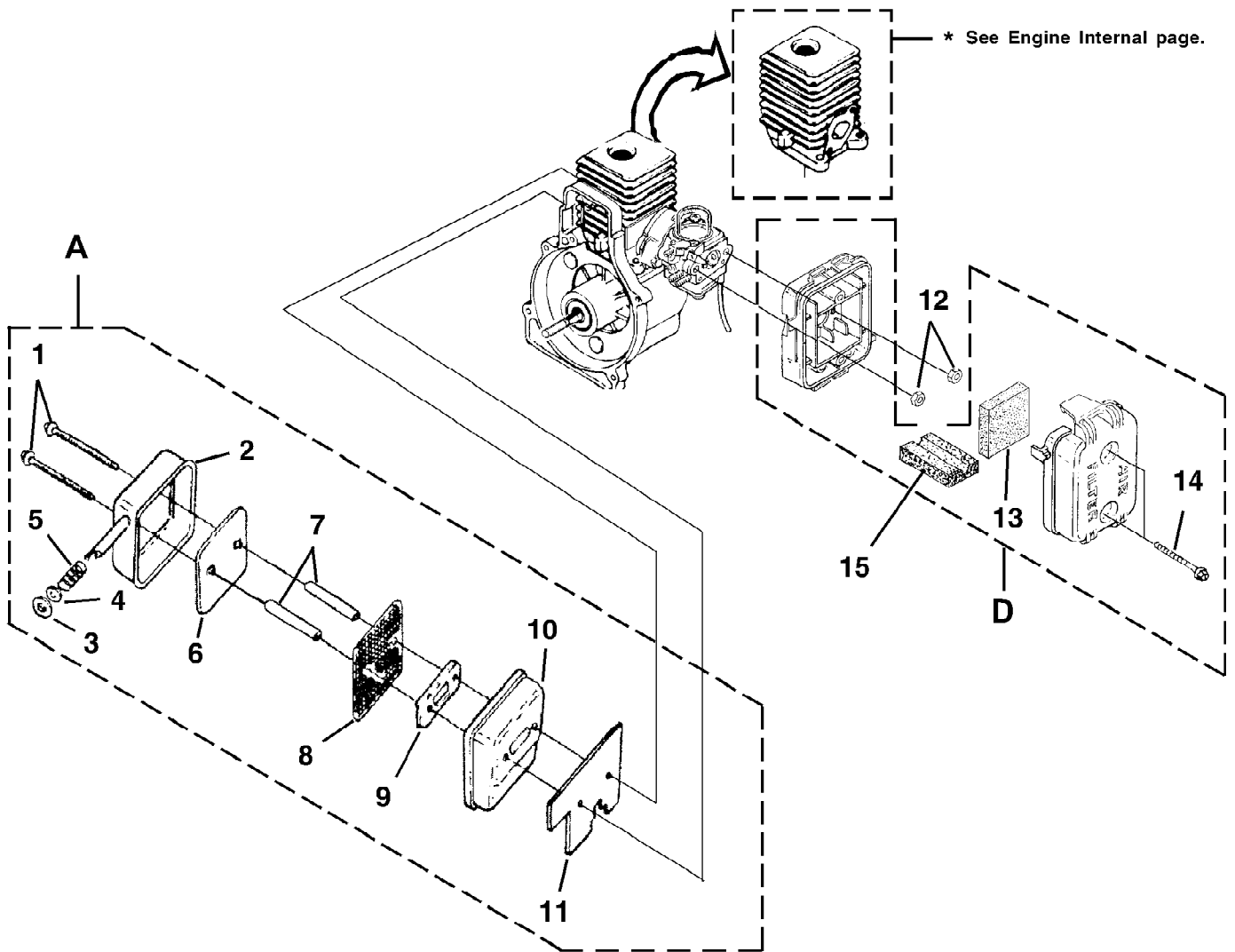

TORQUE SPECIFICATIONS			
Item No.	In/Lbs	Nm	Required Loctite
1	40-50	4.5-5.6	
12	30-40	3.4-4.5	
14	30-40	3.4-4.5	

d25mha Blower UT-08086
Muffler And Air Cleaner

Page 8 of 12

Ref #	Part Number	Qty	S/P/F	Description
A	PA01181	1	/P	MUFFLER-Complete Includes Items 1-11
1	88060	2	S/P	SCREW-Sems Hex Hd. (10-24 x 2 1/2")
2	A00366	1	/P	MUFFLER COVER
3	00381	1	/P	WASHER-Insulating
4	84117	1	/P	WASHER-Flat
5	00387	1	/P	SPRING-Compression
6	00777	1	/P	DEFLECTOR-Muffler
7	04785	2	/P	SPACER-Muffler
8	00388B	1	/P	SCREEN-Spark Arrestor
9	98783	1	/P	PLATE-Reinforcing
10	98781	1	S/P	BODY-Muffler
11	00394B	1	/P	GASKET-Muffler Also included with Short block & Cylinder Kits.
12	81208	2	/P	NUT-Hex (10-24)
D	UP00011	1	/P	AIR FILTER KIT Includes items 13-14
13	98760	1	/P	AIR FILTER
14	093221	2	S/P	SCREW-Thd. Form. (#8-16 x 3/4")
15	04857	1		FOAM AIR FILTER Not Used on UT08111 and UT08111A

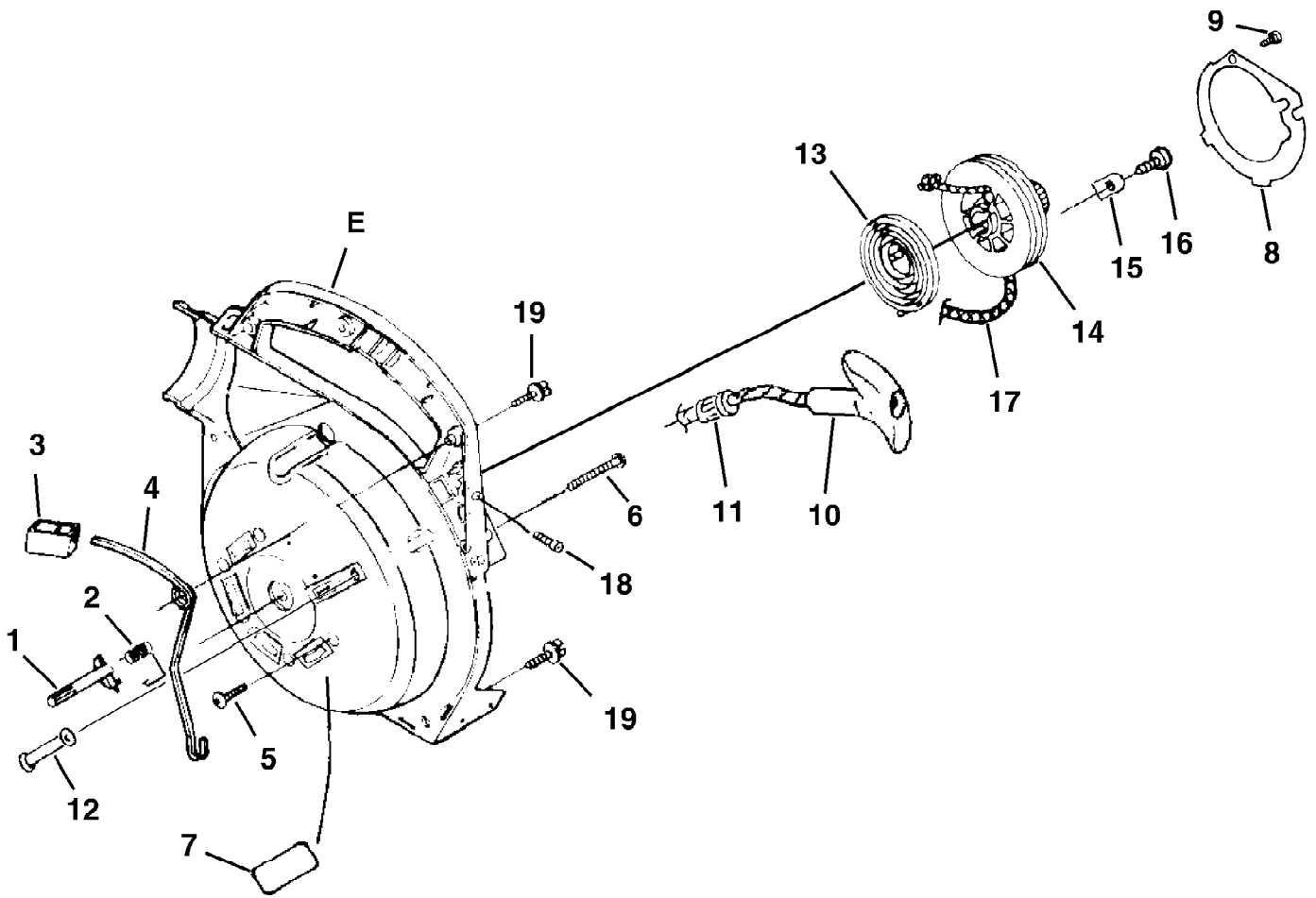

TORQUE SPECIFICATIONS			
Item No.	In/Lbs	Nm	Required Loctite
5	55-60	6.2-6.8	
6	20-30	2.3-3.4	
9	8-12	.9-1.4	
16	30-40	3.4-4.5	
18	20-30	2.3-3.4	
19	20-30	2.3-3.4	

d25mha Blower UT-08086
Starter

Page 10 of 12

Ref #	Part Number	Qty	S/P/F	Description
1	00368A	1	/P	LATCH-Throttle Not Used on UT08111 and UT08111A
2	00370	1	S/P	SPRING-Throttle Latch Not Used on UT08111 and UT08111A
3	00367	1	/P	TRIGGER-Throttle Not Used on UT08111 and UT08111A
4	00369A	1	/P	LEVER-Throttle Not Used on UT08111 and UT08111A
5	82538	4	/P	SCREW-Thread Form. (10-24 X 3/4")
6	JA416903	1	/P	SCREW-Thread Form. (#10 X 1 5/8")
E	UP06792A	1	/P	VOLUTE HOUSING & STARTER Includes items 7-17
7	UP03822A	1	/P	KIT-Sealing Not Used on UT08111 and UT08111A
8	00374	1	/P	PLATE-Rotor
9	82528	1	/P	SCREW-Thread Form. (#6 X 1 3/8")
10	5946702	1	S/P	GRIP-Starter (Yellow) Not Used on UT08111 and UT08111A
	PSO1200	1		GRIP-Starter (Yellow)
11	969811A	1	/P	BUSHING-Starter
12	00364B	1	S/P	GUIDE-Starter Rope
13	A98773A	1	S/P	SPRING & CONTAINER
14	98770A	1	/P	PULLEY-Starter
15	98791	2	/P	BRACKET-Retaining
16	82541	2	/P	SCREW-Thread Form. (#10 X 1/2")
17	9789901	1	/P	ROPE-Starter
18	PS82146	1	S/P	SCREW-Phil. Hd. (8-32 X 5/8") Not Used on UT08111 and UT08111A
19	82563	5	/P	SCREW-Thread Form. (10-24 X 3/4")

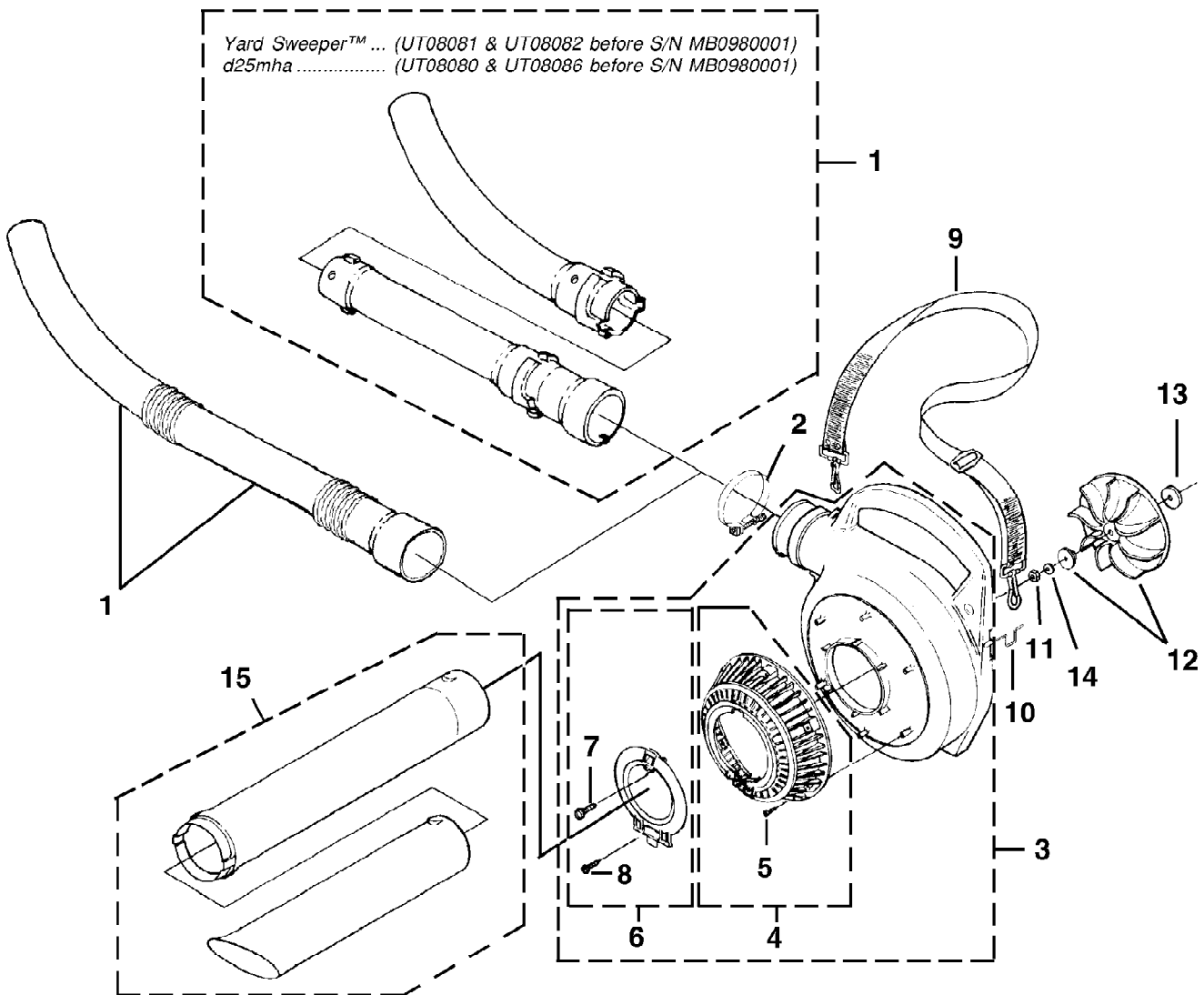

TORQUE SPECIFICATIONS			
Item No.	In/Lbs	Nm	Required Loctite
5	8-12	.9-1.4	
7	10-20	1.1-2.3	
8	8-12	.9-1.4	
11	130-150	14.7-16.9	

d25mha Blower UT-08086
Volute, Fan & Tubes

Page 12 of 12

Ref #	Part Number	Qty	S/P/F	Description
1	984917001	1	/P	BLOWER TUBE KIT
2	00433B	1	S/P	CLAMP w/Fasteners
3	984918001	1	/P	VOLUTE HOUSING KIT Includes Items 4-8
4	UP06720A	1	/P	BLOWER VAC GRILLE KIT Includes Item 5
5	82528	6	/P	SCREW-Thread Form. (#6 X 3/8")
6	984910001	1	/P	ACCESS DOOR KIT Includes Items 7-8
7	82312	1	/P	SCREW-Thread Rolling (#10 X 5/8")
8	82376	1	/P	SCREW-Thread Form. (#8 X 1/2")
9	96337C	1	/P	SHOULDER STRAP
10	00398	1	/P	WIRE LOOP
11	81124A	1	/P	NUT-Hex (3/8-24)
12	UP06826A	1	S/P	BLOWER FAN KIT
13	03165	2	S/P	WASHER-Flat
14	03163	1	/P	WASHER-Bellville (3/8")
15	UP06705A	1	/P	VACCUM TUBE KIT (Vacuum units only)