

HOMELITE YARD BROOM BLOWERS - MODEL NUMBERS UT08012, UT08512, UT08512A, AND UT08512B

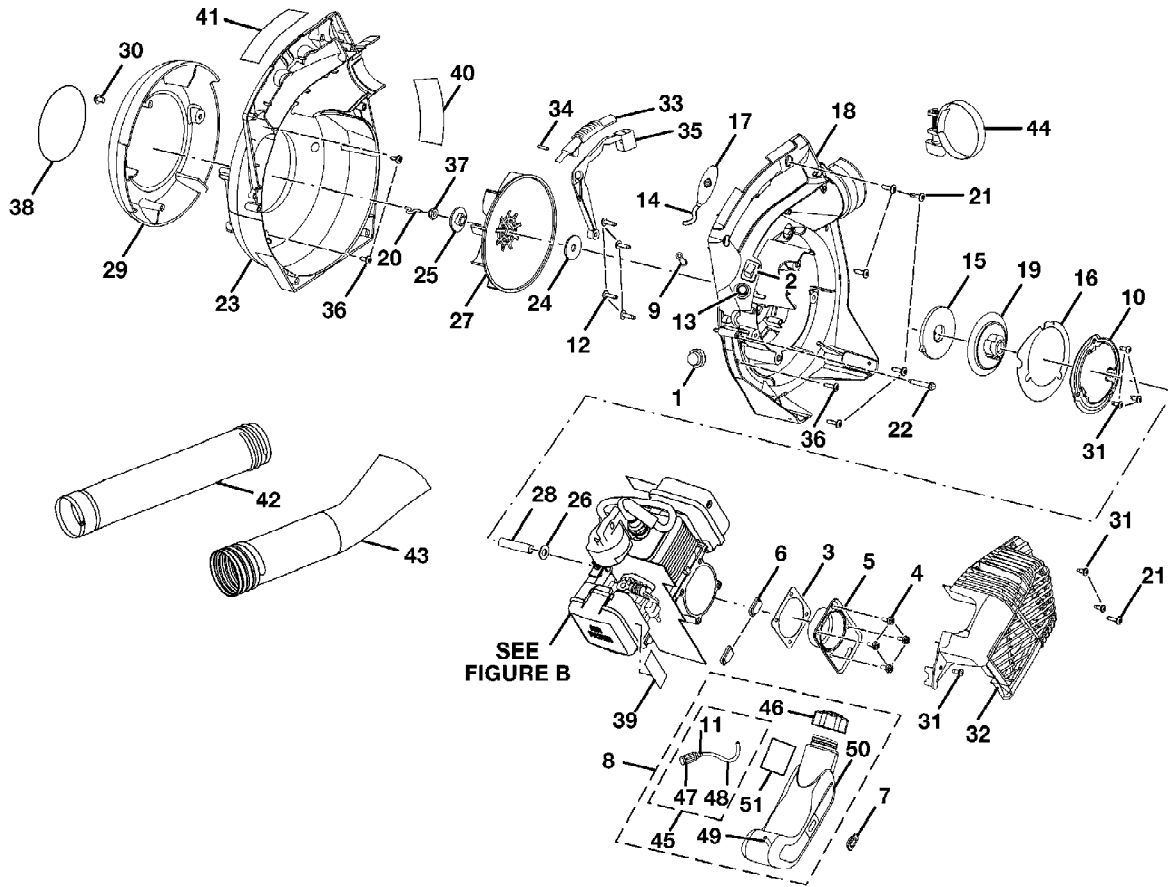

Figure A

Yard Broom II Blower UT-08512
Figure A

Page 2 of 5

Ref #	Part Number	Qty	S/P/F	Description
1	308088001	1	/P	PRIMER BULB
2	760363002	1	S	SWITCH
3	900954001	1	/P	CRANKCASE GASKET
4	660664001	4	S	SCREW (10-24 x 9/16 in. PAN HD.) Purchase locally
5	638031001	1	S	CRANKCASE COVER
6	570256001	2	S	RUBBER BUMPER
7	570549001	1	/P	BIG BUMPER
8	308123004	1	/P	FUEL TANK ASSEMBLY INC. KEY NOS. 45-46, 49-50
9	650013001	1	/P	BUSHING - STARTER ROPE
10	638032001	1	S	BAFFLE PLATE
11	690765001	1	/P	WIRE CLAMP
12	660630002	4	S	SCREW (10-24 x 3/4 in. TRUSS HD.) Purchase locally
13	650014001	1	S	BUSHING STARTER
14	900849004	1	/P	STARTER ROPE
15	638033001	1	/P	SPRING & CONTAINER
16	900957001	1	S	BAFFLE GASKET
17	518073001	1	S	STARTER GRIP
18	518249001	1		INNER VOLUTE HOUSING
19	308134001	1	S	PULLEY ASSEMBLY
20	638074001	1	S	WIRE LOOP
21	660629001	6	S	SCREW (10-14 x 3/4 in. TORX TRUSS HD.) Purchase locally
22	660667001	1	S	SCREW (10 x 1-5/8 in. HEX HD.) Purchase locally
23	518250001	1		OUTER VOLUTE
24	650016001	1	/P	FLAT WASHER
25	640858001	1		FAN ADAPTOR
26	650017001	1	S	FLAT WASHER
27	518077001	1	S	FAN
28	650018001	1		FAN SPACER
29	518078001	1		DOOR
30	660668001	1	S	SCREW (1/4-20 x 3/4) Purchase locally
31	660669001	6	S	SCREW (#8 x 1/2 in. PAN HD.) Purchase locally
32	518251001	1		BLOWER SHROUD
33	518211001	1		SLIDE
34	348007001	1		PIN
35	518247001	1		TRIGGER
36	660618001	3	S	SCREW (10-24 x 3/4 in. TORX TRUSS HD.) Purchase locally
37	660730001	1	S	LOCK NUT (3/8-24) Purchase locally
38	940299487	1		DOOR LABEL (YARD BROOM)
39	940647001	1	/P	CHOKE LABEL
40	940299493	1	S	FAN INTAKE WARNING LABEL
41	940642005	1		WARNING/STARTING LABEL
42	580555001	1	S	UPPER TUBE
43	580556001	1	/P	LOWER NOZZLE

Yard Broom II Blower UT-08512
Figure A

Page 3 of 5

Ref #	Part Number	Qty	S/P/F	Description
44	348005003	1	/P	CLAMP
45	308283001	1	S	FUEL FILTER KIT INC. KEY NOS. 11, 47-48
46	300758006	1	/P	FUEL CAP ASSEMBLY
47	300759003	1	S	FUEL FILTER
48	570258003	1		RUBBER TUBING (165.10 mm)
49	570259005	1		RUBBER TUBING (196.85 mm)
50	580553002	1		FUEL TANK
51	900955001	1	/P	HEAT SHIELD
	983000593	1		OPERATOR'S MANUAL (UT08012 & UT08512)
	983000593R	1		REPAIR SHEET

HOMELITE YARD BROOM BLOWERS – MODEL NUMBERS UT08012, UT08512, UT08512A, AND UT08512B

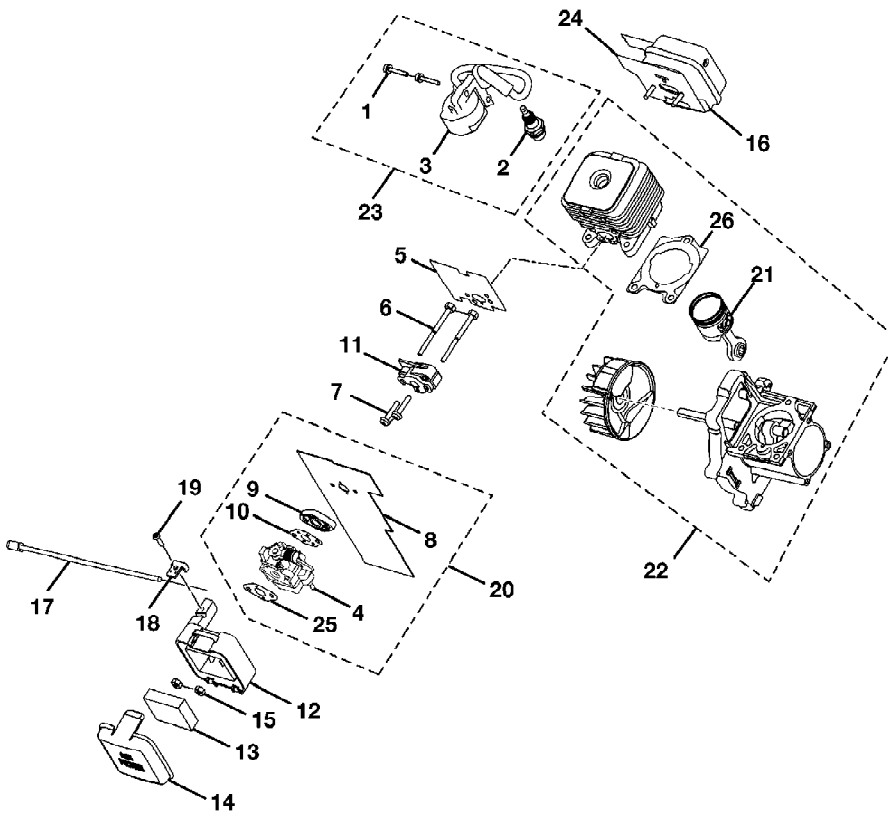

Figure B

Yard Broom II Blower UT-08512
Figure B

Page 5 of 5

Ref #	Part Number	Qty	S/P/F	Description
1	660660001	2	S	SCREW THD FORMING
2	870174001	1	/P	SPARK PLUG CHAMPION RCJ-6Y
3	850080001	1	/P	IGNITION MODULE
4	308028004	1		CARBURETOR
5	900950001	1	/P	HEAT DAM GASKET
6	660346002	2		CARBURETOR MOUNTING BOLT
7	660662001	2	/P	SCREW (10-24 x 1.11 PAN HD.) Purchase locally
8	900951004	1		CARBURETOR GASKET
9	518120001	1	S	SPACER
10	900711003	1	S	GASKET
11	518087001	1	S	HEAT DAM
12	518248001	1		AIR FILTER BOX
13	900952001	1	S/P	AIR FILTER
14	518072001	1	S	AIR FILTER COVER
15	678027001	2	S	HEX NUT (10-24) Purchase locally
16	300748010	1	S	MUFFLER
17	270021002	1		THROTTLE CABLE
18	638133002	1	/P	THROTTLE CABLE CLIP
19	660734001	1	/P	SCREW-FILTER BOX
20	308281001	1		CARBURETOR KIT INC. KEY NOS. 4, 8-10 AND 25
21	308119002	1	/P	PISTON ASSEMBLY KIT
22	308099003	1	/P	SHORT BLOCK ASSEMBLY INC. KEY NOS. 21 AND 26
23	308284001	1	/P	IGNITION KIT INC. KEY NOS. 1-3
24	990994001	1		MUFFLER GASKET
25	900994004	1	/P	GASKET
26	900953001	1	/P	CYLINDER GASKET