

HOMELITE VAC ATTACK II BLOWERS - MODEL NUMBERS UT08042, UT08542, UT08542A, AND UT08542B

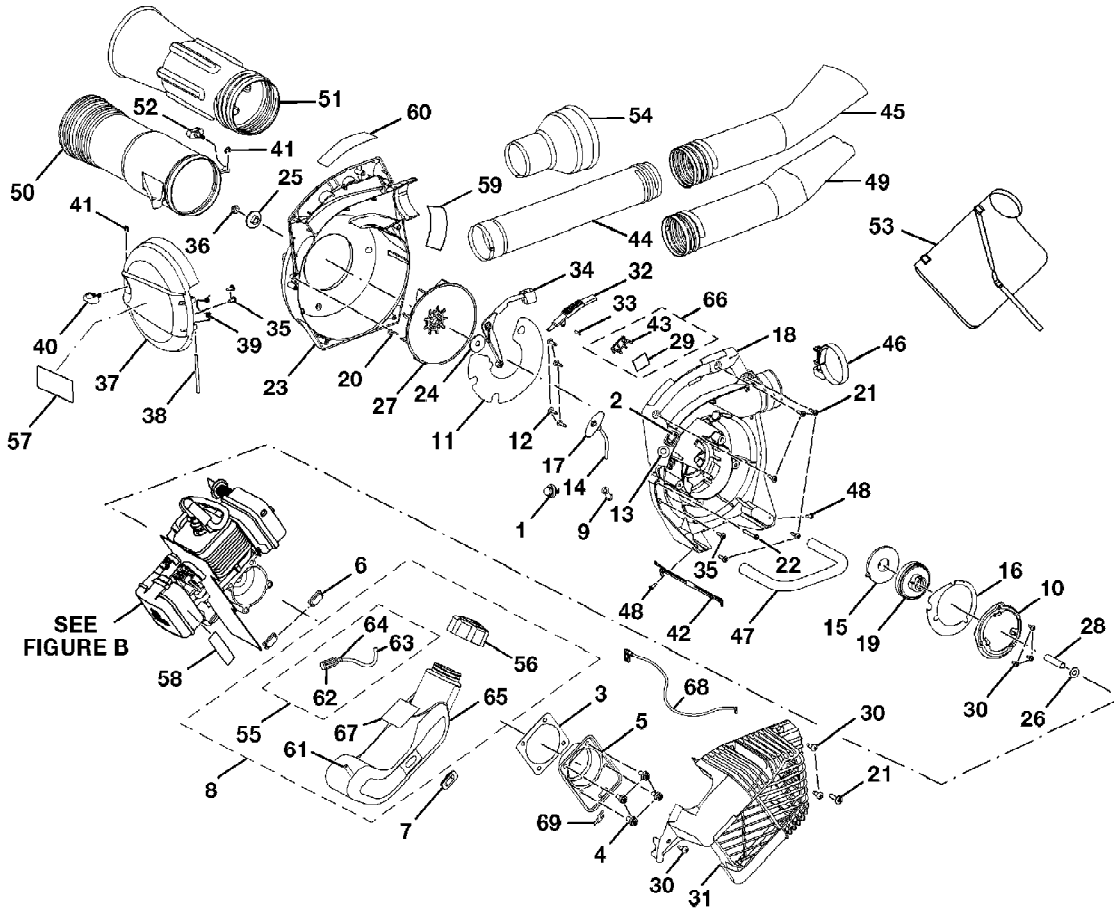

Figure A

Vac Attack II Blower UT-08542
Figure A

Page 2 of 5

Ref #	Part Number	Qty	S/P/F	Description
1	308088001	1	/P	PRIMER BULB
2	760363002	1	S	SWITCH
3	900954001	1	/P	CRANKCASE GASKET
4	660664001	4	S	SCREW (10-24 x 9/16 in. PAN HD.) Purchase locally
5	638031001	1	S	CRANKCASE COVER
6	570256001	2	S	RUBBER BUMPER
7	570549001	1	/P	BIG BUMPER
8	308123004	1	/P	FUEL TANK ASSEMBLY (INC. KEY NOS. 55-56, 61 AND 65)
9	650013001	1	/P	BUSHING-STARTER ROPE
10	638032001	1	S	BAFFLE PLATE
11	650023001	1		INNER VOLUTE SEAL
12	660630002	4	S	SCREW (10-24 x 3/4 in. TRUSS HD.) Purchase locally
13	650014001	1	S	BUSHING STARTER
14	900849004	1	/P	STARTER ROPE
15	638033001	1	/P	SPRING & CONTAINER
16	900957001	1	S	BAFFLE GASKET
17	518073001	1	S	STARTER GRIP
18	518249001	1		INNER VOLUTE HOUSING
19	308134001	1	S	PULLEY ASSEMBLY
20	638074001	1	S	WIRE LOOP
21	660629001	6	S	SCREW (10-14 x 3/4 in. TORX TRUSS HD.) Purchase locally
22	660667001	1	S	SCREW (10 x 1-5/8 in. HEX HD.) Purchase locally
23	518250001	1		OUTER VOLUTE
24	650016001	1	/P	FLAT WASHER
25	640858001	1		FAN ADAPTOR
26	650017001	1	S	FLAT WASHER
27	518077001	1	S	FAN
28	650018001	1		FAN SPACER
29	570581004	1		SCREEN
30	660669001	6	S	SCREW (#8 x 1/2 in. PAN HD.) Purchase locally
31	518251001	1		BLOWER SHROUD
32	518211001	1		SLIDE
33	348007001	1		SLIDE PIN
34	518247001	1		TRIGGER
35	660618001	3	S	SCREW (10-24 x 3/4 in. TORX TRUSS HD.) Purchase locally
36	660730001	1	S	LOCK NUT (3/8-24) Purchase locally
37	518078002	1		DOOR
38	650026001	1	S	DOOR HINGE SHAFT
39	638064001	1	/P	DOOR HINGE SPRING
40	518066002	1		BLOWER KNOB
41	650027001	2		E-RING
42	290195004	1		WIRING HARNESS
43	518229001	1	/P	SCREEN COVER

Vac Attack II Blower UT-08542
Figure A

Page 3 of 5

Ref #	Part Number	Qty	S/P/F	Description
44	580555001	1	S	UPPER TUBE
45	580556001	1	/P	LOWER NOZZLE
46	348005003	1	/P	CLAMP
47	650024001	1	S	LOWER HANDLE
48	660676001	2	S	SCREW (TAP PAN HD.)
49	580559001	1	S	SWEEPER NOZZLE
50	580560001	1	/P	UPPER VACUUM TUBE
51	580561001	1	S	LOWER VACUUM TUBE
52	518066001	1	S	BLOWER KNOB
53	900960001	1	S	LEAF BAG
54	580562001	1	/P	VACUUM BAG TUBE
55	308283001	1	S	FUEL FILTER KIT (INC. KEY NOS. 62-64)
56	300758006	1	/P	FUEL CAP ASSEMBLY
57	940299495	1		DOOR LABEL (VAC ATTACK)
58	940647001	1	/P	CHOKE LABEL
59	940299493	1	S	FAN INTAKE WARNING LABEL
60	940642005	1		WARNING/STARTING LABEL
61	570259005	1		RUBBER TUBING (196.85 mm)
62	300759003	1	S	FUEL FILTER
63	570258003	1		RUBBER TUBING (114.3 mm)
64	690765001	1	/P	WIRE CLAMP
65	580553002	1		FUEL TANK
66	900961003	1		SCREEN COVER & NETTING ASSEMBLY (INC. KEY NOS. 29 & 43)
67	900955001	1	/P	HEAT SHIELD
68	290218001	1	S	LEAD W/TERMINALS
69	638081001	1		MALE TAB
	983000594	1		OPERATOR'S MANUAL (UT08042 & UT08542)
	983000781	1		OPERATOR'S MANUAL (UT08542A)
	983000950	1		OPERATOR'S MANUAL (UT08542B)
	983000594R	1		REPAIR SHEET (REV:05)

HOMELITE VAC ATTACK II BLOWERS - MODEL NUMBERS UT08042, UT08542, UT08542A, AND UT08542B

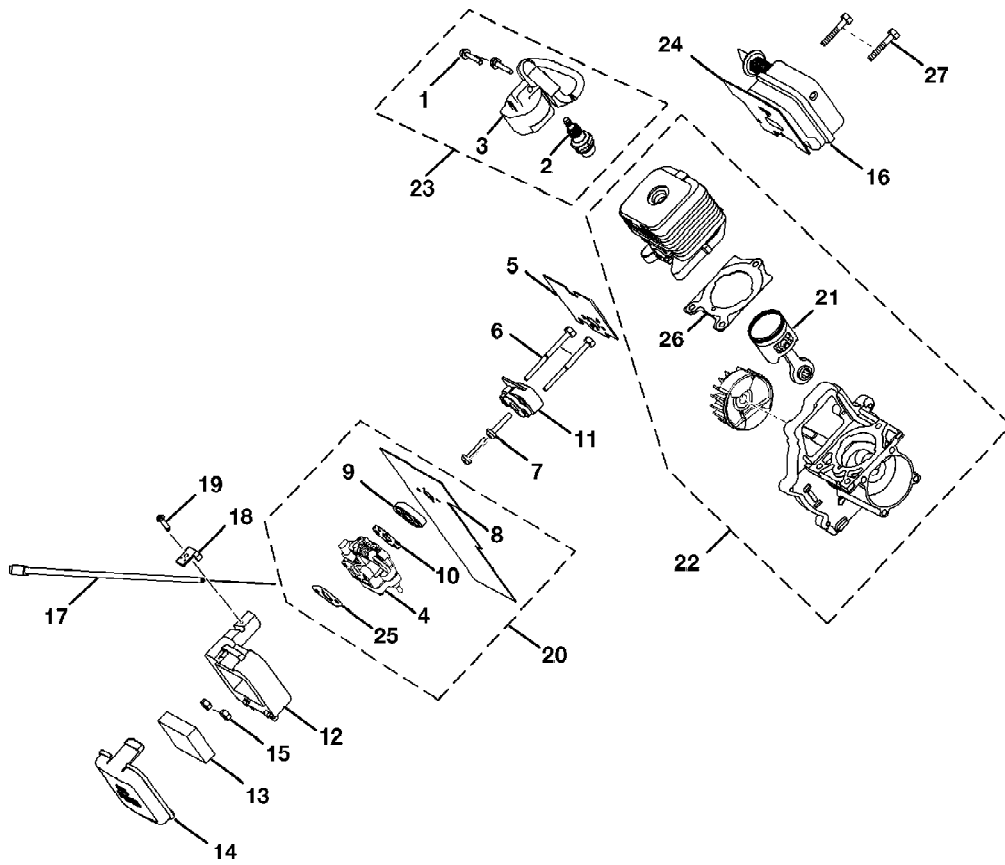

Figure B

Vac Attack II Blower UT-08542
Figure B

Page 5 of 5

Ref #	Part Number	Qty	S/P/F	Description
1	660660001	2	S	SCREW THD FORMING
2	870174001	1	/P	SPARK PLUG CHAMPION - RCJ-6Y
3	850080001	1	/P	IGNITION MODULE
4	308028004	1		CARBURETOR
5	900950001	1	/P	HEAT DAM GASKET
6	660346002	2		CARBURETOR MOUNTING BOLT
7	660662001	2	/P	SCREW (10-24 x 1.11 PAN HD.) Purchase locally
8	900951004	1		CARBURETOR GASKET
9	518120001	1	S	SPACER
10	900711003	1	S	GASKET
11	518087001	1	S	HEAT DAM
12	518248001	1		AIR FILTER BOX
13	900952001	1	S/P	AIR FILTER
14	518072001	1	S	AIR FILTER COVER
15	678027001	2	S	HEX NUT (10-24) Purchase locally
16	300748010	1	S	MUFFLER
17	270021002	1		THROTTLE CABLE
18	638133002	1	/P	THROTTLE CABLE CLIP
19	660734001	1	/P	SCREW-FILTER BOX
20	308281001	1		CARBURETOR KIT (INC. KEY NOS. 4, 8-10 AND 25)
21	308119002	1	/P	PISTON ASSEMBLY KIT
22	308099003	1	/P	SHORT BLOCK ASSEMBLY (INC. KEY NOS. 21, 26)
23	308284001	1	/P	IGNITION KIT (INC. KEY NOS. 1-3)
24	990994001	1		MUFFLER GASKET
25	900994004	1	/P	GASKET
26	900953001	1	/P	CYLINDER GASKET
27	660673001	2	/P	SCREW (10-24 x 2-1/2 in. HEX HD.) Purchase locally