

TORQUE SPECIFICATIONS			
Item No.	In/Lbs	Nm	Required Loctite
12	30-40	3.4-4.5	
14	40-50	4.5-5.6	262 Red

HB25155 Blower UT-08123
Carburetor And Fuel Tank

Page 2 of 12

Ref #	Part Number	Qty	S/P/F	Description
F	UP00136A	1	S/P	FUEL TANK KIT
1	A09116	1	S/P	FUEL CAP (1 5/8" Opening)
2	98792	3	/P	BUMPER-Rubber
3	0143922	2	/P	TUBING-Rubber (5.5")
4	PS03380	1	/P	FUEL FILTER
5	9477225	1	/P	TUBING-Rubber (6 1/4")
6	07332	1	S/P	Fitting, Inlet (small for 2.5mm ID fuel line)
	02067	1	/P	Fitting, Inlet (large for 3mm ID fuel line)
7	4283309	1	/P	INSULATION-Tubing
8	98268	1	S/P	CLAMP
	06443A	1	S/P	GASKET-Crankcase (Not shown)
	PS01565	4	/P	SCREW, Sems (10-24 x .56) (Not Shown)
B	UP00010A	1	/P	CARBURETOR KIT (UT08110 & UT08110A)
9	987661	1	/P	GASKET-Carburetor Also included with Short block & Cylinder Kits.
10	UP03943	1	/P	LEVER-Choke (Walbro WT419,WT469)
B	UP00653A	1	/P	CARBURETOR KIT (Bandit 2000, Yardbroom & D25B)
9	987661	1	/P	GASKET-Carburetor Also included with Short block & Cylinder Kits.
10	UP03941	1	/P	LEVER-Choke (Walbro WT471)
11	00775A	1	S/P	GASKET-Heat Dam Also included with Short block & Cylinder Kits.
12	04474	2	/P	CARB. BOLT Not Shown
13	98768A	1	/P	HEAT DAM
14	093221	2	S/P	SCREW, SEMS (10-24 x 1.110) Also included with Short block & Cylinder Kits.

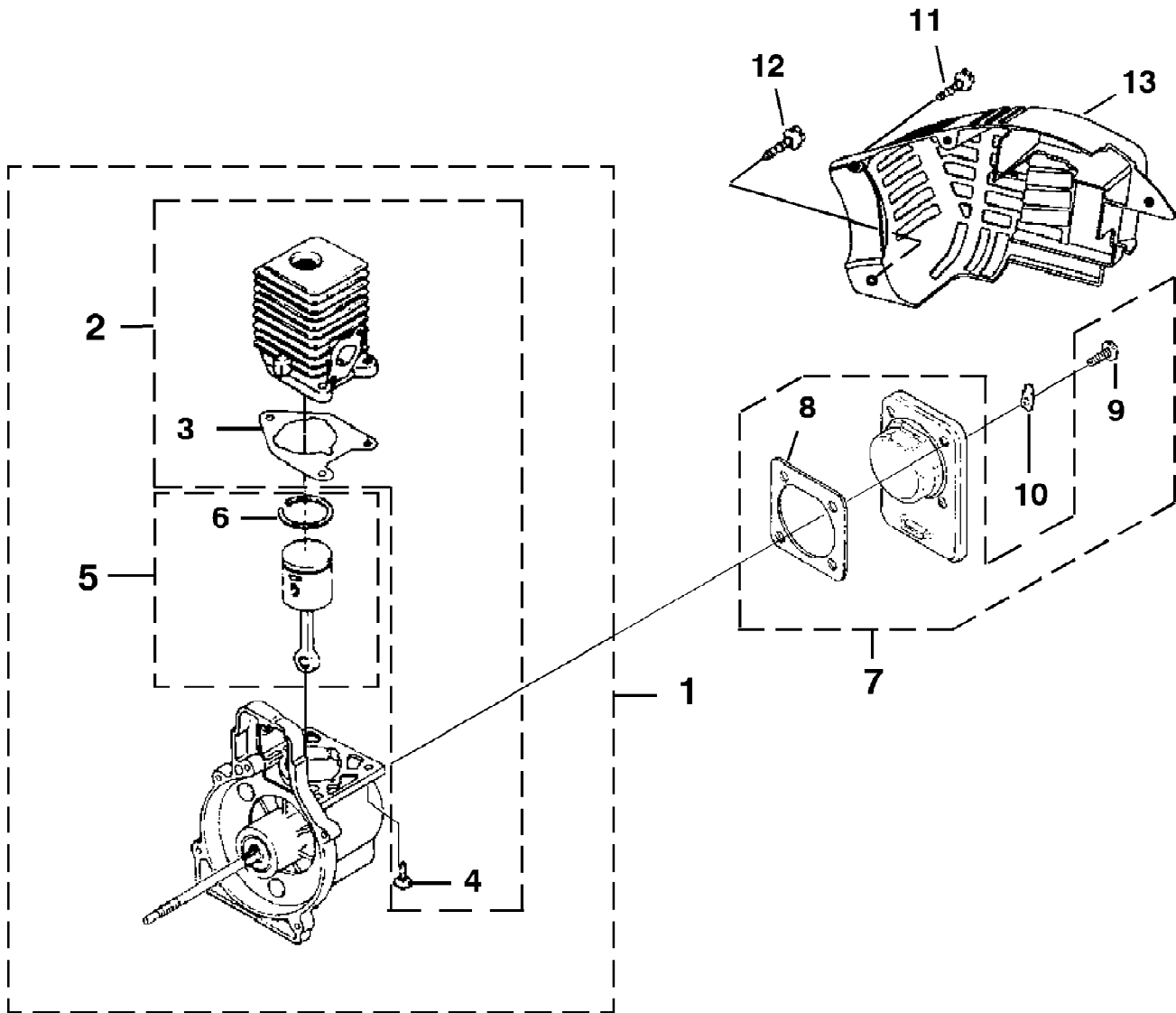

TORQUE SPECIFICATIONS			
Item No.	In/Lbs	Nm	Required Loctite
4	55-65	6.2-7.3	262 Red
9	55-65	6.2-7.3	262 Red
11	8-12	9-1.4	
12	20-30	2.3-3.4	

HB25155 Blower UT-08123
Engine Internal

Page 4 of 12

Ref #	Part Number	Qty	S/P/F	Description
1	UP03131	1		SHORT BLOCK (30cc) Includes items 2-6
2	UP07146	1	S/P	30 CC CYLINDER KIT Includes items 2-4
3	04388B	1	S/P	GASKET-Cylinder Also included with Short block & Cylinder Kits.
4	PS02807	3	/P	SCREW, SEMS (12-24 x 3/4)
	00775A	1	S/P	GASKET-Heat Dam (Not Shown)
	00394B	1	/P	GASKET-Muffler (Not Shown)
5	UP03366	1	S	30 CC PISTON & ROD Includes item 6
6	03179	2	/P	RING-Piston
1	UP03133A	1	/P	SHORT BLOCK (25cc) Includes items 2-6
2	UP04136A	1	S/P	25 CC CYLINDER KIT Includes items 2-4
3	04388B	1	S/P	GASKET-Cylinder
4	PS02807	3	/P	SCREW, SEMS (12-24 x 3/4)
	00775A	1	S/P	GASKET-Heat Dam (Not Shown)
	00394B	1	/P	GASKET-Muffler (Not Shown)
5	984544001	1	/P	25 CC PISTON & ROD Includes item 6
6	PS01359	1	S/P	RING-Piston
7	PS02130	1	/P	CRANKCASE COVER-Stamped Steel Includes items 8-9
8	06443A	1	S/P	GASKET-Crankcase Also included with Short block & Cylinder Kits.
9	PS01565	4	/P	SCREW, SEMS (10-24 x .56) Also included with Short block & Cylinder Kits.
10	02851	1	/P	TAB-Male (Not for UT08110 & UT08110A)
11	82376	3	/P	SCREW-Thread Form. (#8 X 1/2")
12	82563	6	/P	SCREW-Thread Form. (#10 X 3/4")
13	UP06522A	1	/P	SHROUD

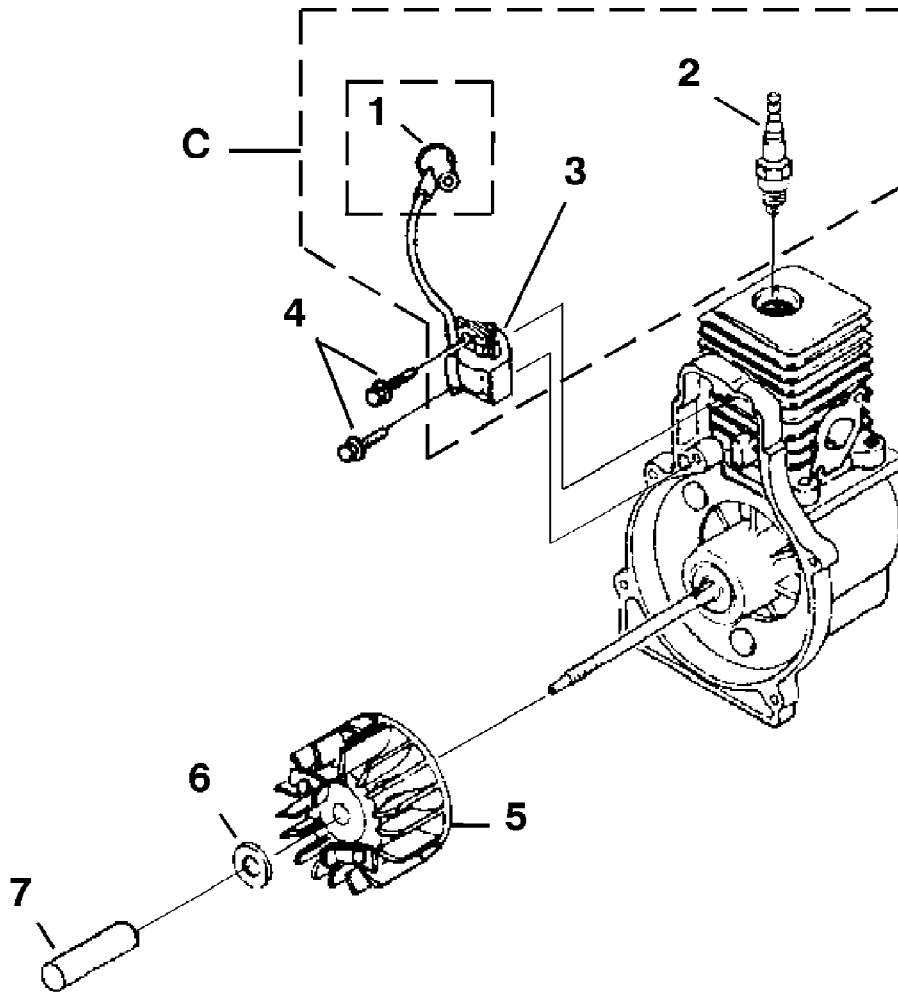

TORQUE SPECIFICATIONS			
Item No.	In/Lbs	Nm	Required Loctite
2	120-180	13.6-20.3	
4	30-40	3.4-4.5	242 Blue

HB25155 Blower UT-08123
Ignition With Rotor

Page 6 of 12

Ref #	Part Number	Qty	S/P/F	Description
C	UP03858	1	/P	IGNITION KIT w/Module Includes items 1-3
1	UP03868	1	S/P	TERMINAL and COVER
2	PS02227	1	S/P	SPARK PLUG
3	01341B	1		IGNITION Module
4	82540	2	/P	SCREW-Thread Form. (8-32 x 1")
5	984521001	1	S	ROTOR & STARTER PAWLS
6	95479A	1	/P	WASHER-Flat
7	PS03566	1	S/P	SPACER-Fan

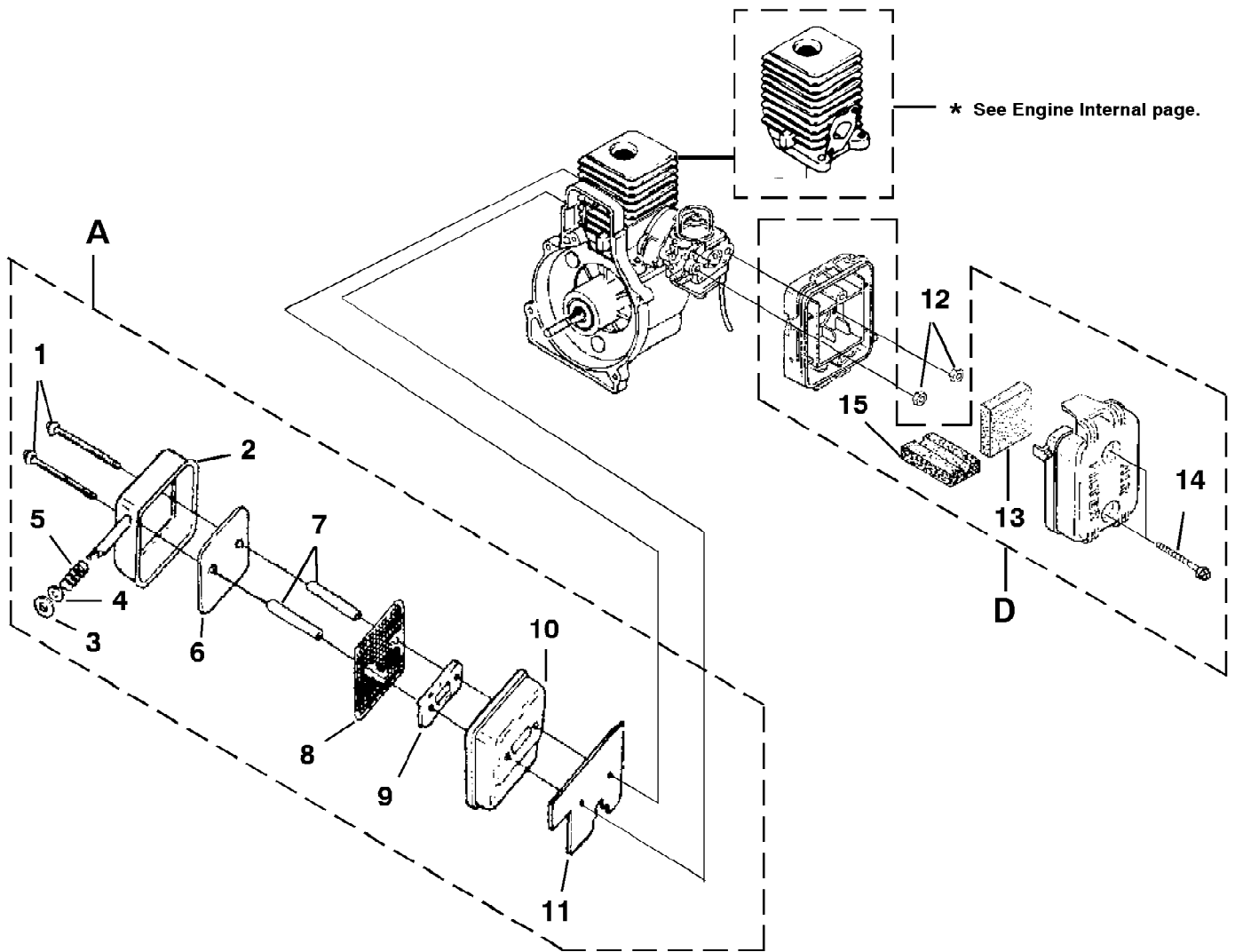

TORQUE SPECIFICATIONS			
Item No.	In/Lbs	Nm	Required Loctite
1	40-50	4.5-5.6	
12	30-40	3.4-4.5	
14	30-40	3.4-4.5	

HB25155 Blower UT-08123
Muffler And Air Cleaner

Page 8 of 12

Ref #	Part Number	Qty	S/P/F	Description
A	PA01181	1	/P	MUFFLER-Complete Includes items 1-11
1	88060	2	S/P	SCREW-Sems Hex Hd. (10-24 x 2 1/2")
2	A00366	1	/P	MUFFLER COVER
3	00381	1	/P	WASHER-Insulating
4	84117	1	/P	WASHER-Flat
5	00387	1	/P	SPRING-Compression
6	00777	1	/P	DEFLECTOR-Muffler
7	04785	1	/P	SPACER-Muffler
8	00388B	1	/P	SCREEN-Spark Arrestor
9	98783	1	/P	PLATE-Reinforcing
10	98781	1	S/P	BODY-Muffler
11	00394B	1	/P	GASKET-Muffler Also included with Short block & Cylinder Kits.
12	81208	2	/P	NUT-Hex (10-24)
D	UP00011	1	/P	AIR FILTER KIT Includes items 13-15
13	98760	1	/P	AIR FILTER
14	093221	2	S/P	SCREW-Thd. Form. (#8-16 x 3/4")
15	04857	1		FILTER, Foam Air
D	985059001	1		AIR FILTER KIT For UT08110 And UT08110A
13	98760	1	/P	AIR FILTER For UT08110 And UT08110A
14	093221	2	S/P	SCREW-Thd. Form. (#8-16 x 3/4") For UT08110 And UT08110A

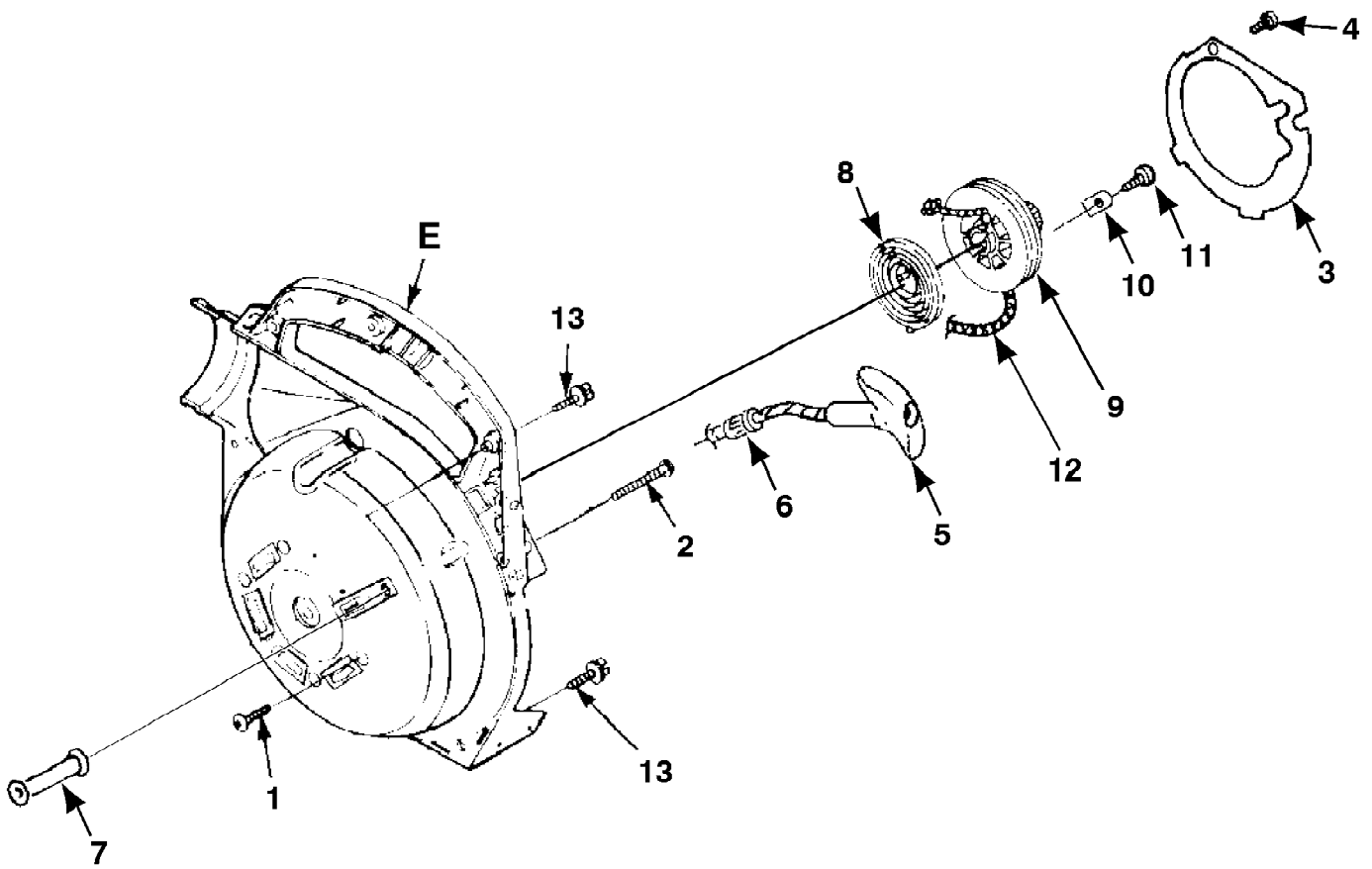

TORQUE SPECIFICATIONS			
Item No.	In/Lbs	Nm	Required Loctite
1	55-60	6.2-6.8	
2	20-30	2.3-3.4	
4	8-12	9-1.4	
11	30-40	3.4-4.5	
13	20-30	2.3-3.4	

HB25155 Blower UT-08123
Starter

Page 10 of 12

Ref #	Part Number	Qty	S/P/F	Description
1	82538	4	/P	SCREW-Thread Form. (10-24 X 3/4")
2	JA416903	1	/P	SCREW-Thread Form. (#10 X 1 5/8")
E	UP04551A	1	/P	VOLUTE HOUSING & STARTER Includes items 3-12
3	00374	1	/P	PLATE-Rotor
4	82528	1	/P	SCREW-Thread Form. (#6 X 1 3/8")
5	PS00179	1	/P	GRIP-Starter (Black)
6	969811A	1	/P	BUSHING-Starter
7	00364B	1	S/P	GUIDE-Starter Rope
8	A98773A	1	S/P	SPRING & CONTAINER
9	98770A	1	/P	PULLEY-Starter
10	98791	2	/P	BRACKET-Retaining
11	82541	2	/P	SCREW-Thread Form. (#10 X 1/2")
12	9789901	1	/P	ROPE-Starter
13	82563	6	/P	SCREW-Thread Form. (10-24 X 3/4")

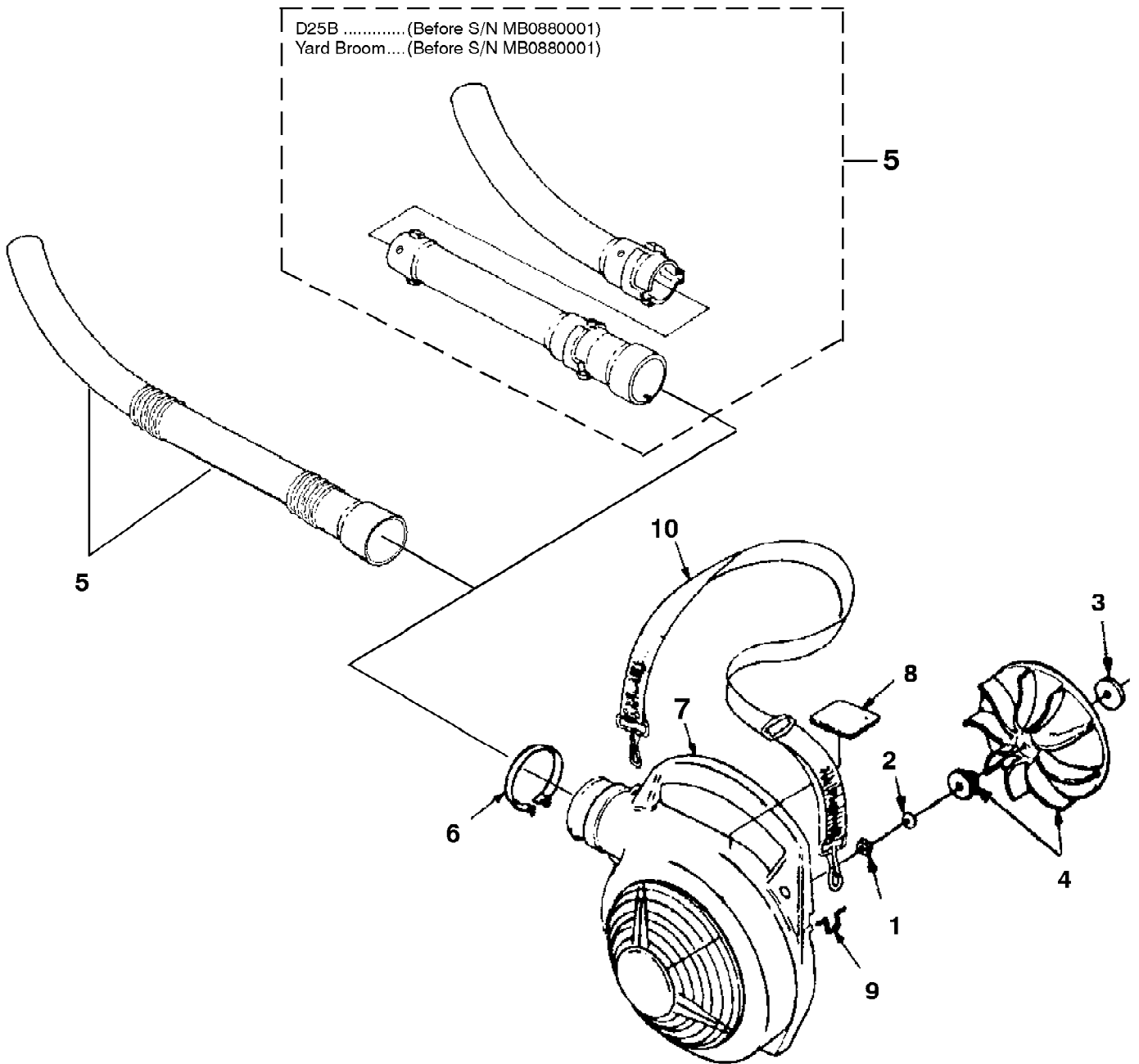

TORQUE SPECIFICATIONS			
Item No.	In/Lbs	Nm	Required Loctite
1	130-150	14.7-16.9	

HB25155 Blower UT-08123
 Volute, Fan & Tubes

Page 12 of 12

Ref #	Part Number	Qty	S/P/F	Description
1	81124A	1	/P	NUT-Hex (3/8-24)
2	03163	1	/P	WASHER-Bellville (3/8")
3	03165	2	S/P	WASHER-Flat
4	UP06826A	1	S/P	BLOWER FAN KIT
5	984917001	1	/P	TUBE KIT
6	00433B	1	S/P	CLAMP w/Fasteners
7	UP00757A	1	/P	VOLUTE HOUSING (Outer) Includes item 8
8	08483	1	/P	DECAL-Warning
9	00398	1	/P	LOOP-Wire
10	96337C	1	/P	SHOULDER STRAP (NOT FOR UT8110 & UT8110A)