

No
Diagram
Available

Parts List
Only

d3300c Chain Saw UT-10882
Accessories

Page 2 of 12

Ref #	Part Number	Qty	S/P/F	Description
	PT12371MD	1		Guide Bar (Power Tip) 12" (3/8")
	PT14371MD	1	/P	Guide Bar (Power Tip) 14" (3/8")
	PT16371MD	1	/P	Guide Bar (Power Tip) 16" (3/8")
	PT18371MD	1	/P	Guide Bar (Power Tip) 18" (3/8")
	H1N7245AH	1		Chain (3/8")
	H1N7252AH	1	S	Chain (3/8")
	H1N7256AH	1	S	Chain (3/8")
	H1N7262AH	1	S	Chain (3/8")
	PS24823	1	/P	Sealant Silicon
	0745499	1	/P	Rubber tubing (10')
	09207	1	/P	Wrench - Combination
	18416	1		Digital Tachometer
	18453	1	/P	Grease, Multi-purpose
	94194	1	/P	Compression Tester
	1856601	1	/P	Bit, Torx T27
	UP04562A	1		Carry Case
	UP06732A	1	/P	Bumper Spike Kit

d3300c Chain Saw UT-10882
 Carburetor - Muffler - Air Filter

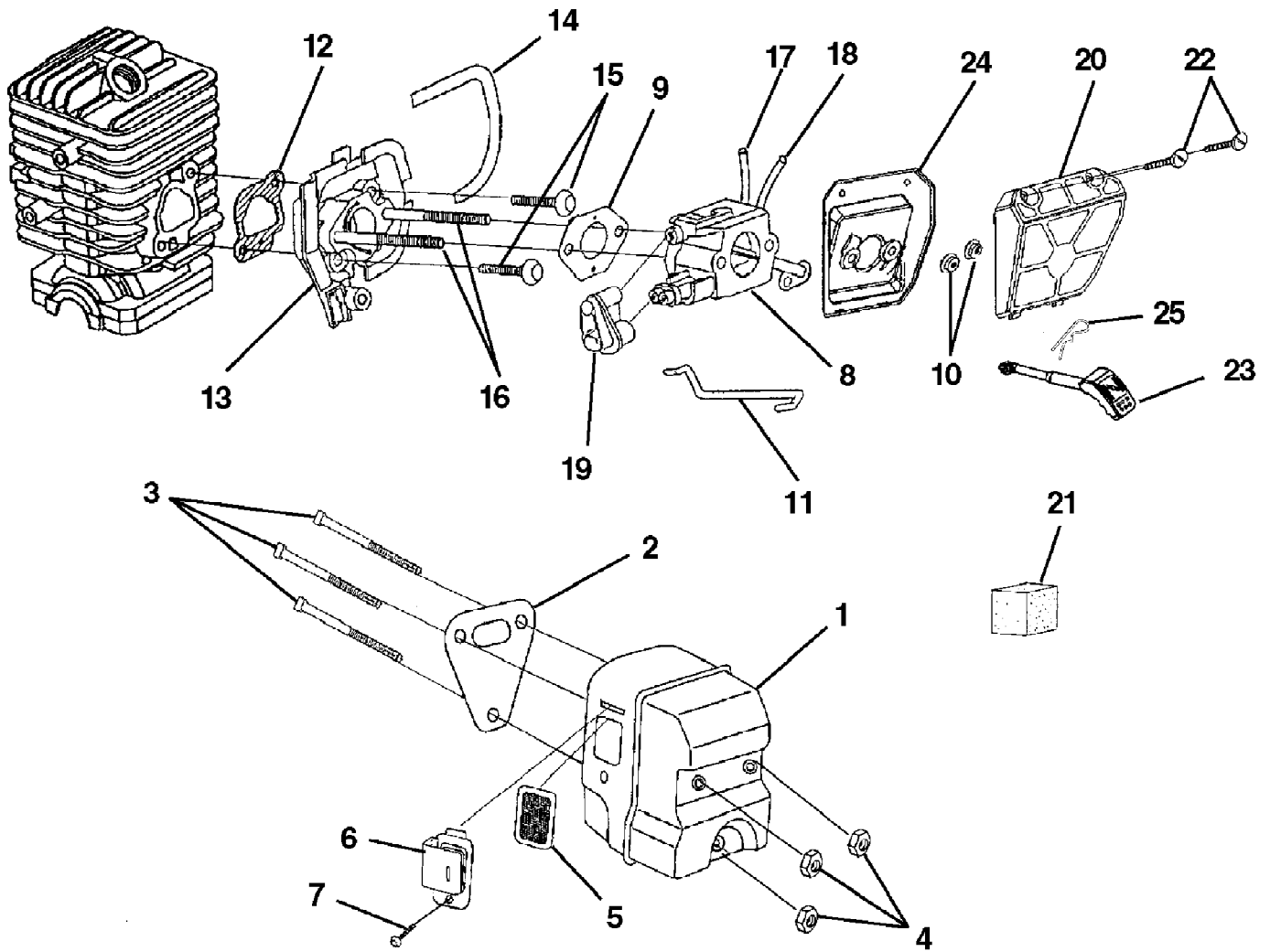

Item No.	Torque Specs		Required Loctite
	In/Lbs	Nm	
4	50-60	5.6-6.7	
10	30-40	3.4-4.5	
15	45-55	5.0-6.2	
22	15-20	1.7-2.3	

d3300c Chain Saw UT-10882
Carburetor - Muffler - Air Filter

Page 4 of 12

Ref #	Part Number	Qty	S/P/F	Description
1	984890001	1	S	Muffler Kit Includes items 2-7
2	900848001	1	/P	Muffler Gasket
3	PS04525	3	S/P	Screw-Square Hd.
4	81206	3	S/P	Nut-Locking Hex (10-32)
5	07394	1	/P	Screen, Spark
6	07396A	1	/P	Deflector, Muffler
7	95922	1	/P	Screw (8-32 x .312)
8	A09159A	1	/P	Carburetor Assembly Includes items 9-10
9	98339	1	S/P	Carburetor Gasket
10	07589	2	/P	Flange Nut (10-24)
11	PS01591	1	S/P	Throttle Wire
12	06840A	1	/P	Gasket, Heat Dam
13	04916	1	/P	Carburetor Spacer
14	06873	1	/P	Seal, Heat Dam
15	82539	2	S/P	Screw, Truss Hd. Taptite (10-24 x 7/8")
16	06852	2	/P	Screw, Carburetor
17	0745434	1	/P	Fuel Line (Tank to Carburetor 8 1/2")
18	0745416	1	/P	Fuel Line (Carburetor to Purge Bulb 4")
19	04907	1	/P	Carburetor Grommet
	UP06753A	1	/P	Air Filter Kit Includes items 20-22
20	04938	1	/P	Air Filter Cover
21	PS05070	1	/P	Pre Filter (In engine housing)
22	82617	2	/P	Screw-Slotted Pan Hd. (8-16 x 5/8")
23	PS06280	1	/P	Rod, Choke
24	04937	1	/P	Air Filter Plate
25	08939	1	/P	Spring Clip (Choke Rod)

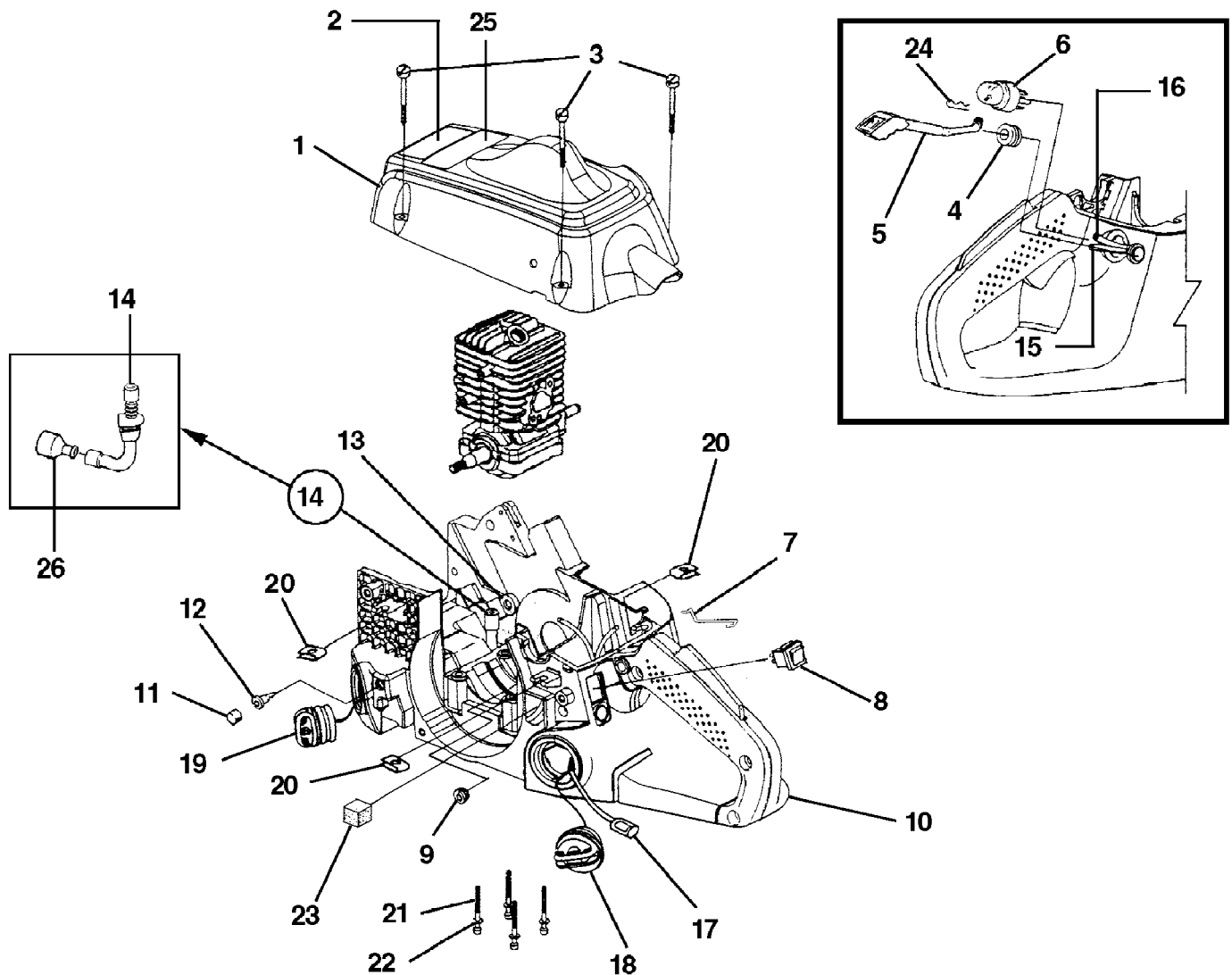

Item No.	Torque Specs		Required Loctite
	In/Lbs	Nm	
3	15-25	1.7-2.8	
21	65-75	7.3-8.5	262 Red

d3300c Chain Saw UT-10882
 Engine Housing - Fuel Tank - Oil Tank

Page 6 of 12

Ref #	Part Number	Qty	S/P/F	Description
1	A09162A	1	/P	Cylinder Cover Kit Includes items 2-3
2	PS06324	1	S/P	Safety Decal
3	07597	3	S/P	Screw-Slotted Pan Hd.
4	64862	1	/P	Grommet
5	PS06280	1	/P	Rod, Choke
6	01183	1	/P	Bulb, Air Purge
7	PS01591	1	S/P	Throttle Wire
8	PS02369	1	/P	Switch, Rocker
9	07587	1	/P	Grommet-Split
10	UP06751A	1	/P	Engine Housing Includes items 11-19
11	07403	2	S/P	Element, Filter (Bronze)
12	03134	2	S/P	Duck Bill Valve
13	06841	1	/P	Oil Outlet Grommet
14	PA01037	1	/P	Oil Intake Tube
15	0745422	1	/P	Rubber Tubing (5 1/2")
16	0745434	1	/P	Rubber Tubing (8 1/2")
17	PS03380	1	/P	Fuel Filter
18	DA07590	1	S	Fuel Cap w/ Retainer
19	DA07591	1		Oil Cap w/ Retainer
	A68593	1		Oil Filter (See No. 26)
	PS04881	2	/P	Guide Bar Bolt (Not Shown)
20	07598	3	/P	Speed Nut ("U-Type")
21	82527	4	S/P	Screw, Cap-Socket Hd. (10-24 x 2")
22	84008	4	S/P	Washer
23	PS05070	1	/P	Pre Filter
24	08939	1	/P	Spring Clip (Choke Rod)
25	PS03893	1	S/P	Kickback-Decal
26	A68593	1		Oil Filter

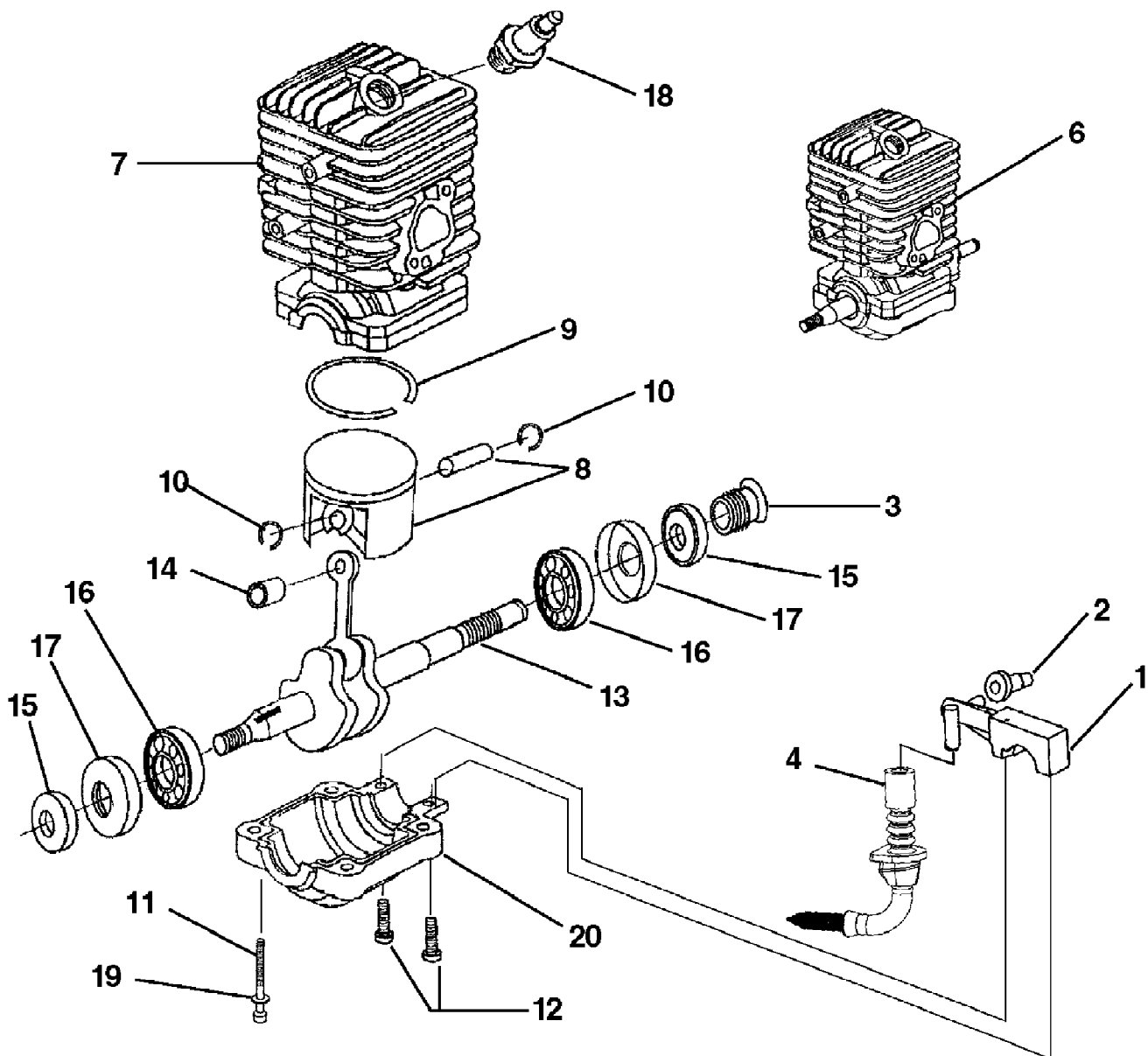

Item No.	Torque Specs		Required Loctite
	In/Lbs	Nm	
11	65-75	7.3-8.5	262 Red
12	15-20	1.7-2.3	
18	120-180	13.6-20.3	

d3300c Chain Saw UT-10882
Engine Internal - Oil Pump

Page 8 of 12

Ref #	Part Number	Qty	S/P/F	Description
1	UP06602	1	/P	Oil Pump Kit Includes items 2-4
2	06841	1	/P	Grommet, Oil Outlet
3	06847	1	S/P	Left Hand Worm
4	PA01037	1	/P	Oil Intake Tube w/Filter
6	UP03119A	1	/P	Short Block, Complete (33cc) Includes items 7-17
	UP04161	1	/P	Short Block, Complete (38cc)
7	A08666A	1	/P	Cylinder Kit (33cc)
	A08667	1	S/P	Cylinder Kit (38cc)
	900848001	1	/P	Gasket, Muffler (Not Shown)
	06840A	1	/P	Gasket, Heat Dam (Not Shown)
	98339	1	S/P	Gasket, Carburetor (Not Shown)
8	UP06971A	1	/P	Piston & Pin (33cc) Includes items 8-10
9	04933	1	/P	Piston Ring
10	64813	2	/P	Ring, Retaining
8	UP06972A	1	/P	Piston & Pin (38cc) Includes items 9-10
9	06857	1	/P	Piston Ring
10	64813	2	/P	Ring, Retaining
11	82527	4	S/P	Screw, Cap-Socket Hd. (10-24 x 2")
12	PS04989	2	/P	Screw, Pan Hd., (8-32 x 5/8")
13	PA00979	1	/P	Crankshaft & Rod Assembly
14	PS04921	1	/P	Bearing, Needle
15	04920	2	S/P	Shaft Seal
16	A04931A	2	S	Bearing & Rubber Case
17	04919	1	S/P	Rubber Case
18	PS02227	1	S/P	Spark Plug
19	84008	4	S/P	Washer
20	04909	1	/P	Lower Crankcase

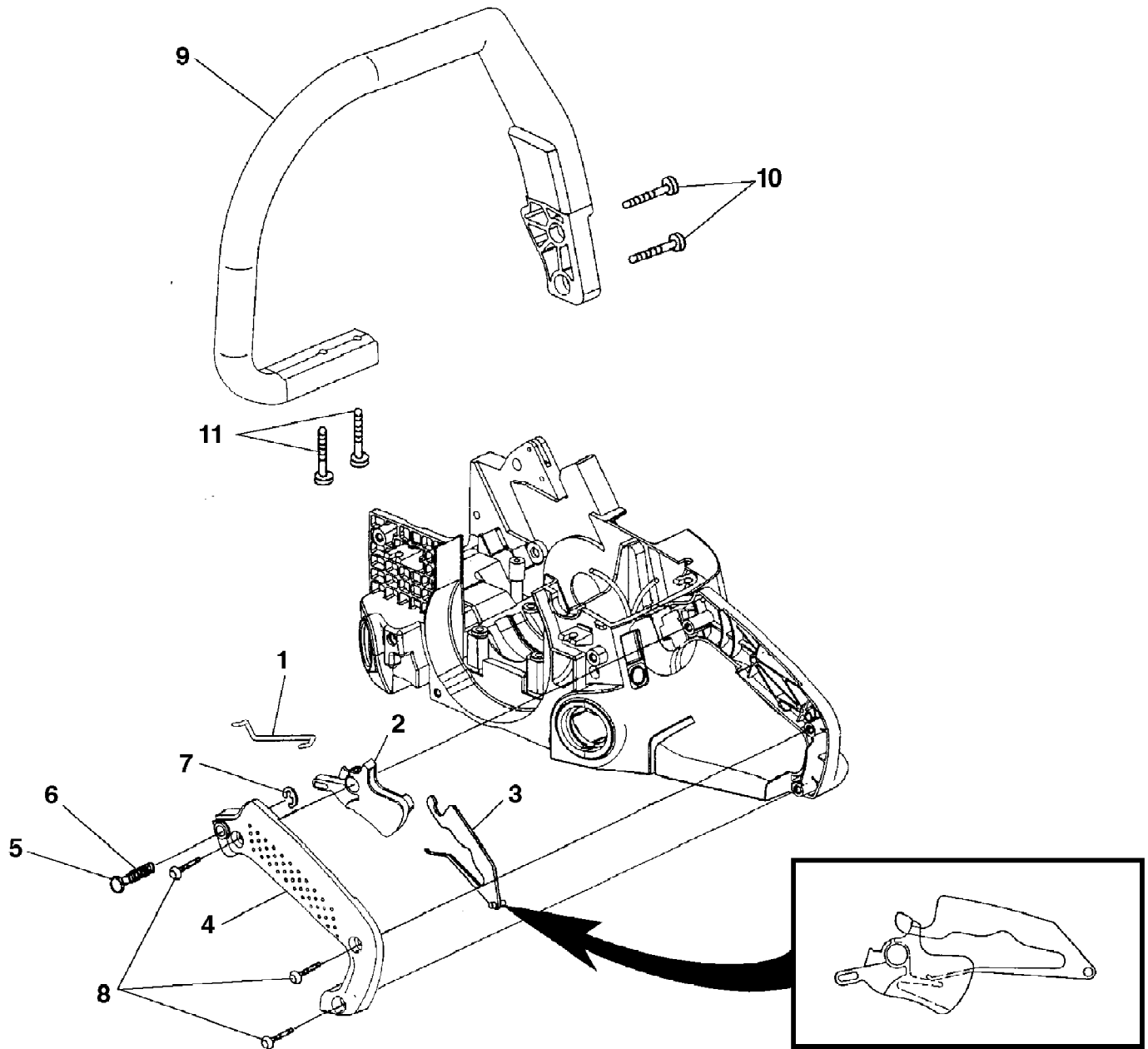

Item No.	Torque Specs		Required Loctite
	In/Lbs	Nm	
8	30-40	3.4-4.5	
10	30-40	3.4-4.5	
11	30-40	3.4-4.5	

d3300c Chain Saw UT-10882
Handles

Page 10 of 12

Ref #	Part Number	Qty	S/P/F	Description
1	PS01591	1	S/P	Throttle Wire
2	PS0396801	1		Trigger, Throttle
3	PS06283	1	/P	Throttle Lock Out
4	UP06736A	1	/P	Handle Cover Kit Includes items 5-7
5	PS0396701	1	/P	Throttle Lock Pin
6	08898	1	/P	Spring, Compression
7	58409	1	/P	Ring, Retainer
8	82563	3	/P	Screw, Thread Form., Plastite (10-14 x 3/4")
9	UP06974A	1	S/P	Front Handle Kit Includes items 10-11
10	82537	2	/P	Screw, Plastite (10-14 x 5/8")
11	82589	2	/P	Screw, Truss Hd.

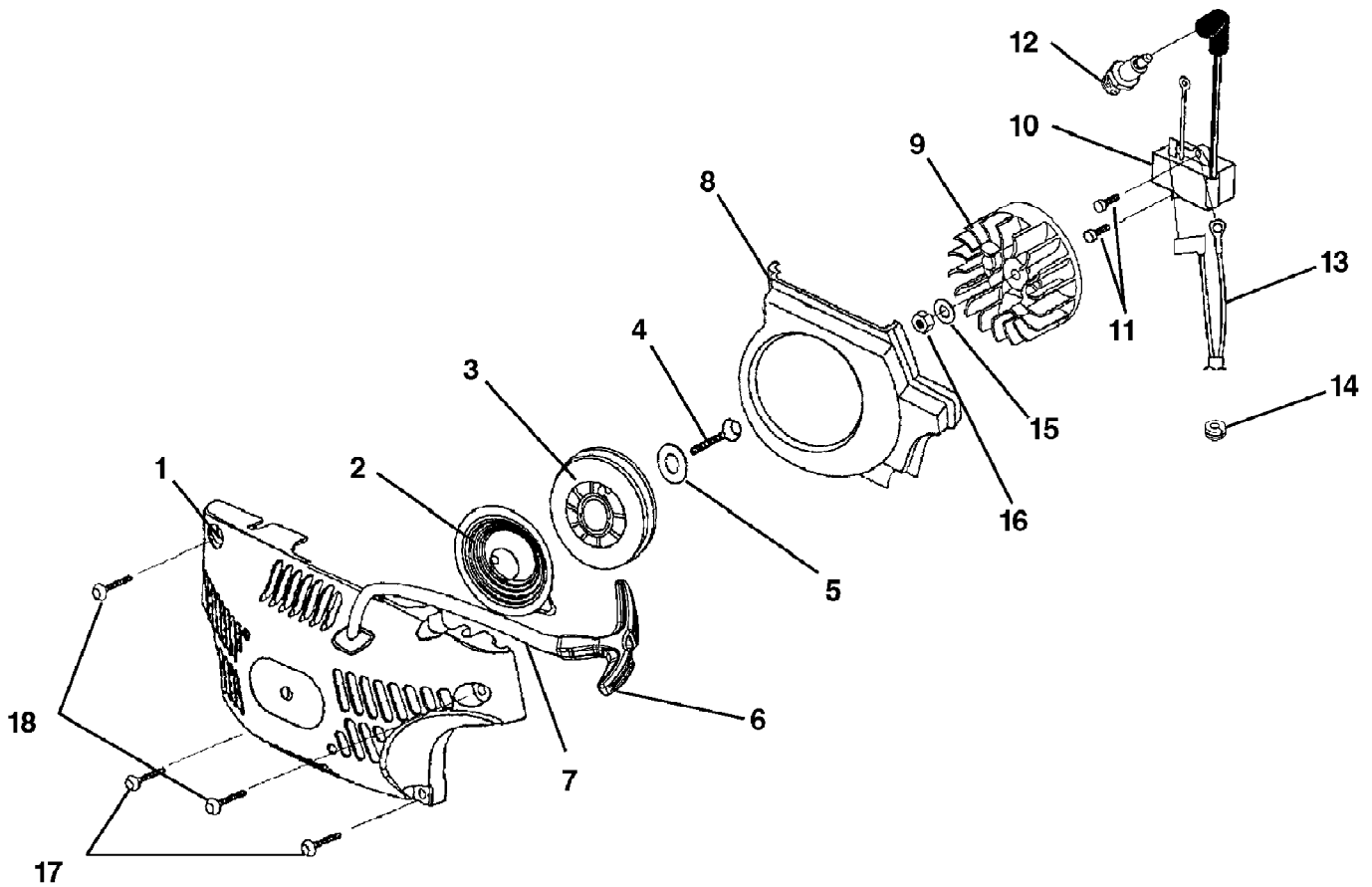

Item No.	Torque Specs		Required Loctite
	In/Lbs	Nm	
4	30-40	3.4-4.5	
11	30-40	3.4-4.5	242 Blue
12	120-180	13.6-20.3	
16	100-150	11.3-16.9	
17	30-40	3.4-4.5	
18	30-40	3.4-4.5	

d3300c Chain Saw UT-10882
Starter - Ignition

Page 12 of 12

Ref #	Part Number	Qty	S/P/F	Description
1	UP06749A	1	S/P	Starter Kit Includes items 2-7
2	A97908	1	/P	Spring & Container
3	PS03117	1	/P	Pulley, Starter
4	82621	1	/P	Screw, Thread Form, Plastite (10-14 x 5/8")
5	94062	1	/P	Washer, Retaining
6	PS06114	1	/P	Grip, Starter
7	9789901	1	/P	Rope, Starter 46"
8	06876	1	/P	Baffle, Fan Housing
9	UP05850A	1	S	Rotor & Starter Pawl
10	UP07865A	1	/P	Ignition Kit (33cc models) PHELON Includes item 11
	UP05851A	1	/P	Ignition Kit (38cc models) WALBRO Includes item 11; Both kits include:
11	82575	2	S/P	Screw, Thread Form (8-32 x 5/8")
12	PS02227	1	S/P	Spark Plug
13	A07602A	1	/P	Ignition Switch Harness
14	07587	1	/P	Grommet, Wire Harness (Split)
15	PS84065	1	S/P	Washer, Flat
16	985730001	1	S	Nut, Jam
17	82620	2	/P	Screw, Truss Hd., Plastite (10-14 x 7/8")
18	82621	2	/P	Screw, Truss Hd., Plastite (10-14 x 5/8")