

HOMELITE 33cc CHAIN SAW – MODEL NUMBERS UT10514 & UT10516

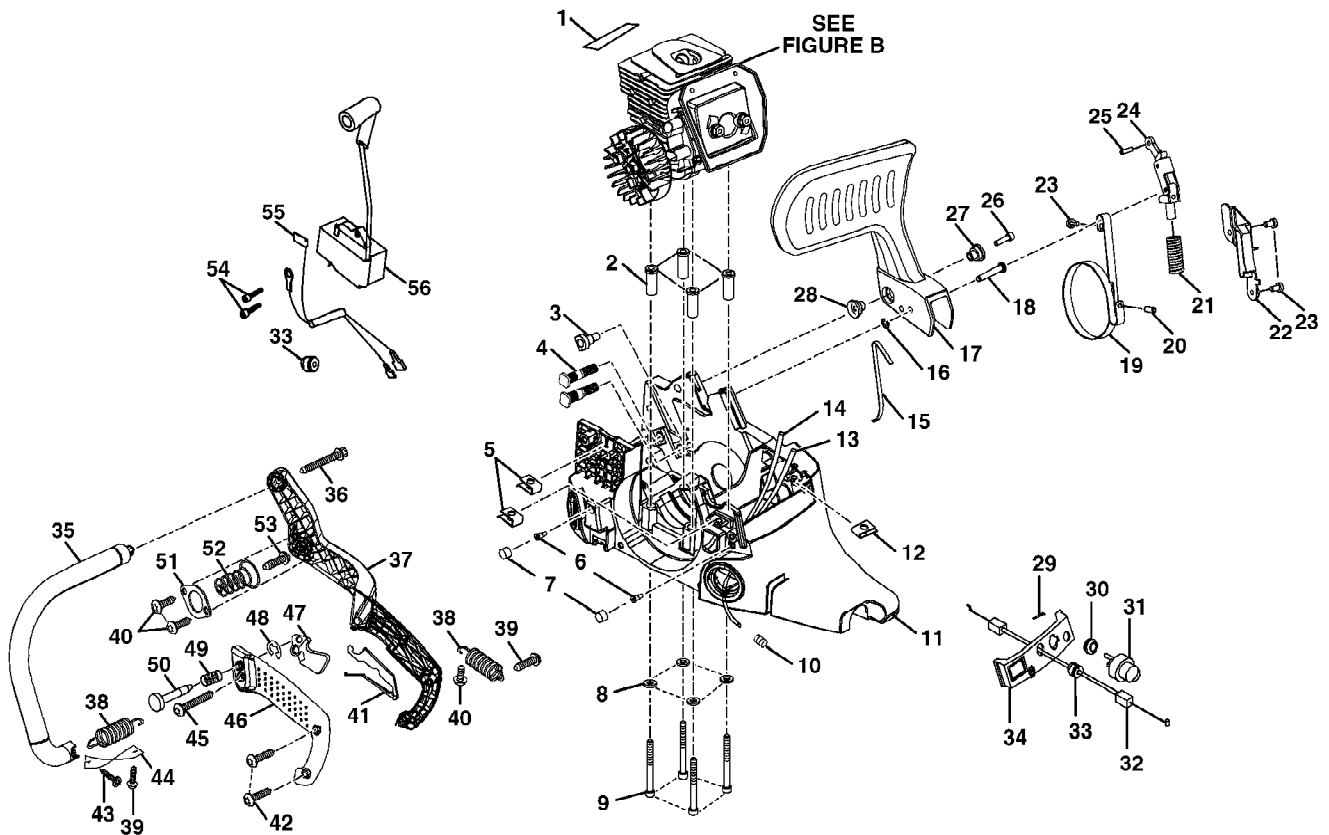

Figure A

33cc Chain Saw UT-10514  
Figure A

Page 2 of 8

Ref #	Part Number	Qty	S/P/F	Description
1	700106001	1		Heat Reflector Tape
2	671087001	4		Spacer Insert
3	570226001	1	S	Oil Outlet Grommet
4	660628001	2	S	Guide Bar Bolt
5	671077001	2	S	Speed Nut ("U"-Type)
6	560955001	2	/P	Duck Bill Valve
7	671088001	2	/P	Element
8	671080001	4	/P	Washer
9	660622001	4	/P	Screw (10-24 x 2 in.) Purchase locally
10	690765001	1	/P	Hose Clamp
11	300951001	1		Chassis Assembly
12	671077002	1		Speed Nut ("U"-Type)
13	570247002	1	S	Rubber Tubing/07454-22
14	570247003	1	S	Rubber Tubing/07454-34
15	631052001	1	S	Spring
16	671075001	1	S	Retaining Ring
17	511723010	1	S	Handguard
18	620282001	1	/P	Handguard Actuating Pin
19	631063002	1	S	Chain Brake Band Kit
20	671095001	1	/P	Spring Pin (Big)
21	678113001	1	S	Spring
22	511720002	1		Chain Brake Cover
23	660634001	3	/P	Screw (8-16 x 5/16 in.) Purchase locally
24	300954001	1	S	Chain Brake Link Assembly
25	671099001	1	S	Spring Pin (Small)
26	660635001	1	S	Screw (8-32 x 5/8 in.) Purchase locally
27	671096001	1	/P	Pivot (Right Hand)
28	671097001	1	/P	Pivot (Left Hand)
29	631034001	1	S	Hair Pin
30	570219001	1		Grommet
31	300780002	1	S	Primer Assembly
32	900845001	1	/P	Throttle Cable
33	570227001	2	S	Split Grommet
34	511719001	1	S	Control Panel
35	511724001	1	S	Front Handle
36	660631001	1	S	Screw (12-14 x 1.5 in.) Purchase locally
37	511721004	1		Rear Handle
38	671101001	2	S	Extension Spring
39	660632001	2	S	Screw (10-14 x 5/8 in.) Purchase locally
40	660618001	3	S	Screw (10-14 x 1/2 in.) Purchase locally
41	511710001	1	S	Lockout Throttle
42	660629001	2	S	Screw (10-14 x 3/4 in.) Purchase locally
43	660719001	1		Screw (10-14 Thread Twin Helix) Purchase locally
44	631050001	1	S	Spring Retainer
45	660633001	1	S	Screw (10-14 x 1 3/8 in.) Purchase locally
46	511722003	1		Handle Cover
47	511712001	1	S	Trigger Throttle
48	671074001	1	S	E-Ring
49	671073001	1	S	Spring
50	511711001	1	S	Throttle Lock Pin
51	631051001	1		Isolator Plate
52	671098001	1	S	Isolator Spring

33cc Chain Saw UT-10514  
Figure A

Page 3 of 8

Ref #	Part Number	Qty	S/P/F	Description
53	660630001	1	/P	Screw (10-24 x 5/8 in.) Purchase locally
54	660639001	2	/P	Screw (8-32 x 5/8 in.) Purchase locally
55	290195002	1		Ignition Switch Harness
56	300953003	1	/P	Ignition Kit

HOMELITE 33cc CHAIN SAW – MODEL NUMBERS UT10514 & UT10516

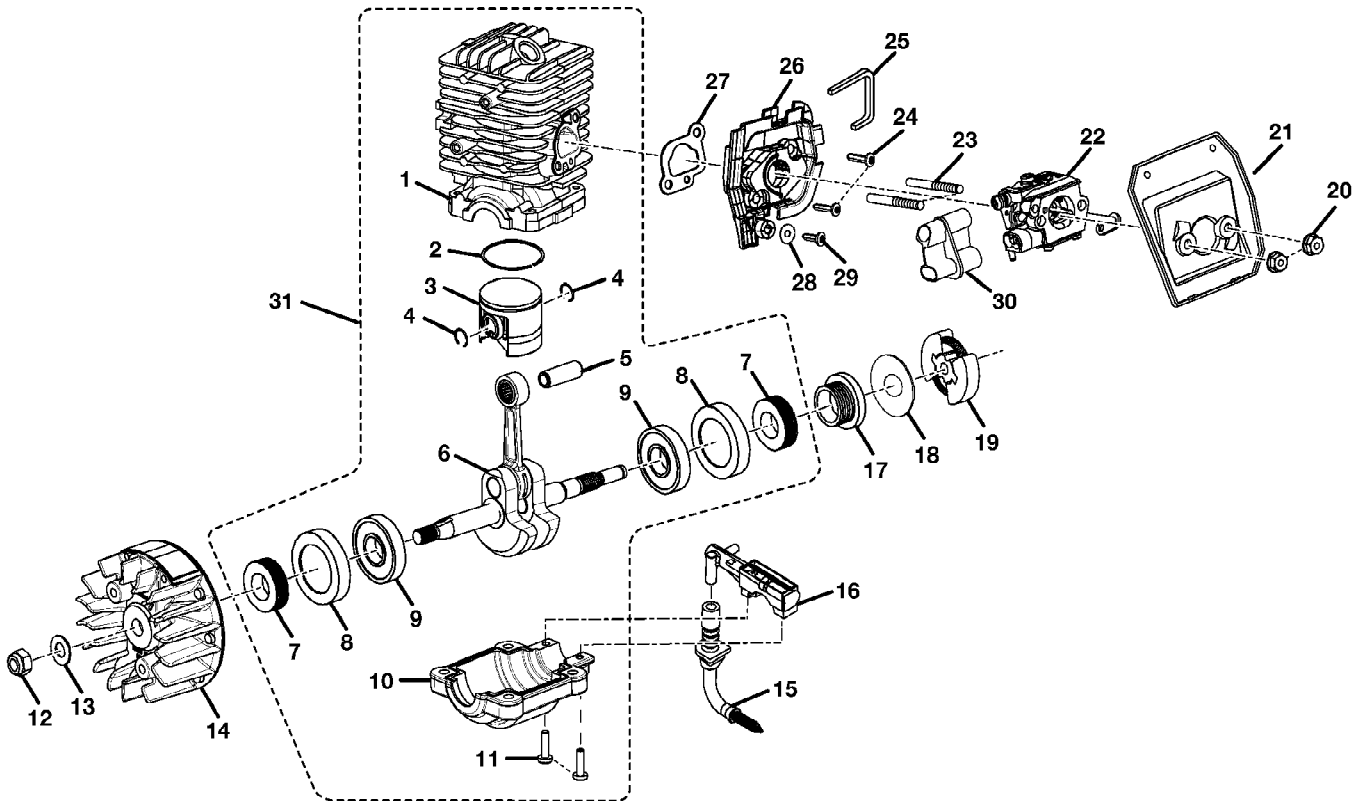

Figure B

33cc Chain Saw UT-10514  
Figure B

Page 5 of 8

Ref #	Part Number	Qty	S/P/F	Description
1	640819015	1		Cylinder
2	690161005	1	S	Piston Ring
3	640995001	1		Piston
4	671082001	2	S	Retaining Ring
5	620277001	1	/P	Piston Pin
6	300943005	1		Crankshaft Assembly
7	570220001	2	/P	Shaft Seal
8	570221001	2	/P	Bearing Case
9	671089002	2		Ball Bearing
10	640818001	1	S	Crankcase
11	660627001	2	S	Screw (8-32 x 5/8 in.) Purchase locally
12	678123001	1	/P	Nut (5/14-24)
13	631049001	1	S/P	Flat Washer
14	300952002	1		Flywheel Assembly
15	300950001	1	S	Oil Intake Tube Assembly
16	300945001	1	S	Oil Pump Assembly
17	610389001	1		Left Hand Worm
18	631061001	1	S	Thrust Washer
19	300960003	1	/P	Clutch Assembly
20	678033001	2	S	Flange Nut (10-24) Purchase locally
21	511707001	1	S	Air Filter Plate
22	300939002	1	S/P	Carburetor Assembly
23	660638001	2	S	Screw (10-24 x 2 1/8 in.) Purchase locally
24	660616002	2		Screw (10-24 x 7/8 in.) Purchase locally
25	900850001	1	S	Spacer Seal
26	511706001	1	S	Carburetor Spacer
27	900842001	1	S	Heat Dam Gasket
28	671072001	1	S	Flat Washer
29	660618001	1	S	Screw (10-14 x 1/2 in.) Purchase locally
30	511705001	1	S	Carburetor Grommet
31	309891002	1		Short Block Assembly (Inc. Key Nos. 1~11)



33cc Chain Saw UT-10514  
General Assembly

Page 7 of 8

Ref #	Part Number	Qty	S/P/F	Description
1	671076001	2	/P	Guide Bar Nut (5/16-18)
2	310625001	1	S	Guide Bar (UT10514 - 14 in. With Safe-T-Tip) (Includes Key Nos. 43, 44)
3	308116001	1	/P	Guide Bar Adjustment Screw
4	631038001	1	S/P	Outer Guide Plate
5	660619001	1		Screw (6-19 x 1/2 in. T.F.) Purchase locally
6	660636001	3	/P	Screw (10-16 x 1-1/2 in. Special) Purchase locally
7	511726001	1	S	Top Cover
8	660617001	2	S	Screw (8-16 x 5/8 in. Torx T.F.) Purchase locally
9	511708001	1	S	Air Filter Cover
10	870174001	1	/P	Spark Plug (Champion RCJ6Y)
11	660625001	1	S	Screw (10-24 x 5/8 in. Torx Pan HD.) Purchase locally
12	511727001	1	S	Fan Housing Baffle
13	308067001	1		Starter Assembly
14	660632001	2	S	Screw (10-14 x 5/8 in., Truss HD.) Purchase locally
15	300948001	1	/P	Fuel Cap Assembly
16	300949001	1	/P	Oil Cap Assembly
17	660624001	1	S	Screw (8-32 x 5/16 in.) Purchase locally
18	638467001	1		Muffler Deflector
19	638673001	1		Spark Screen
20	309314001	1		Muffler Assembly (Incl. Key No. 17-19)
21	671079001	3	/P	Lock Nut (10-32) Purchase locally
22	660626001	3	/P	Screw (10-32 x 2-4/5 in., Square Head)
23	631055001	1	S	Combination Wrench
24	901212001	1	S	Chain (UT10514 - .375 x 52 Link, 14 in.)
25	300957015	1		Chain Cover Assembly
26	900844001	1	S	Pre-Filter
27	631036001	1	S	Inner Guide Plate
28	671103001	1	S	E-Ring
29	631060001	1	S	Cupped Washer
30	300958001	1	/P	Sprocket Drum And Bearing Assembly (.375 Chain)
31	631039001	1	S	Spike Bar
32	678027002	1	S	Lock Nut (10-24) Purchase locally
33	300759005	1		Fuel Filter
34	631035001	1	S	Chain Catcher
35	901210001	1		Muffler Gasket
36	638455001	1		Heat Shield
37	511709001	1	S	Choke Knob
38	760338001	1	S	Ignition Switch
39	660637001	2	S	Screw (10-14 x 7/8 in., Truss Hd. Purchase locally)
40	580438003	1		Scabbard (UT10514 - 14 in., Not Shown)
41	660621001	1	S	Screw (10-24 x 1/2 in.) Purchase locally
42	660618001	1	S	Screw (10-14 x 1/2 in.) Purchase locally
43	308949001	1		Safety Tip

33cc Chain Saw UT-10514  
General Assembly

Page 8 of 8

Ref #	Part Number	Qty	S/P/F	Description
44	660640001	1		Screw (Hex Head)
	987000208	1		Operator's Manual (960970010)