

---

# The Green Machine®

---

## OWNER'S MANUAL

### MODEL 2130

SERIAL NO.

ENGINE

SHAFT

**IMPORTANT NOTE:** USE THE ABOVE BOXES TO FILL IN YOUR MODEL'S SERIAL NUMBER FOR YOUR RECORDS.

## ASSEMBLY AND OPERATING INSTRUCTIONS

---

To insure maximum performance read this manual before putting into operation.

---

### WARRANTY CERTIFICATE

#### TWO (2) YEARS CONSUMER — LIMITED WARRANTY — 90 DAY COMMERCIAL

HMC warrants THE GREEN MACHINE® to be free from defects in material and workmanship under normal use for a period of two (2) years from date of purchase when used by the consumer for residential home use, or 90 days from date of purchase when used commercially.

Should THE GREEN MACHINE® product fail within the warranty period due to defective parts or workmanship, just return the unit transportation prepaid to either (1) the retailer who sold it to you or (2) to your regional distributor, whose address is available from your retailer or (3) directly to HMC Factory Service Center, 20710 South Alameda Street, Long Beach, California 90810, U.S.A. HMC will, at its option, repair or replace the unit at no charge. HMC assumes no obligation to pay the registered owner a cash refund under any circumstances.

Please return the enclosed warranty card within ten (10) days after purchase. If we do not have the warranty card on file we will require other proof of purchase before completing the repairs. This warranty only extends to the original purchaser of the product.

This warranty does not apply if the product has been misused or used contrary to the instruction manual, or if it has been repaired or altered by anyone other than an HMC authorized service center.

This warranty applies only to parts or components which are defective and does not cover repairs necessary due to normal wear, misuse,

accidents, or lack of proper maintenance. Regular, routine maintenance of the unit to keep it in proper operating condition is the responsibility of the owner

HMC IS NOT LIABLE FOR INDIRECT OR CONSEQUENTIAL DAMAGES IN CONNECTION WITH THE USE OF THE PRODUCT INCLUDING ANY COST OF PROVIDING SUBSTITUTE EQUIPMENT DURING PERIODS OF MALFUNCTION.

Some states of the U.S.A. do not allow the exclusion of incidental or consequential damages, so the above exclusion may not apply to you

THE GREEN MACHINE® will perform as indicated in the instruction manual and in the accompanying literature. Your retailer may have sold you the machine with a promise that it would handle a particular task. You may return the machine to him if it does not perform that specific task, but we cannot be responsible for promises which are beyond the scope of the above instruction manual or literature.

THERE ARE NO EXPRESS WARRANTIES OTHER THAN AS CONTAINED IN THIS STATEMENT, AND ANY IMPLIED WARRANTIES SHALL EXPIRE 90 DAYS AFTER DATE OF PURCHASE. Some states of the U.S.A. do not allow limitations on how long an implied warranty lasts, so the above limitations may not apply to you.

This warranty gives you specific legal rights and you may also have other rights which vary from state to state

---

### WARNING

**ALWAYS WEAR SAFETY GOGGLES.**

**NEVER OPERATE UNIT WITHOUT SHIELDS AND GUARDS IN PLACE.**

**USE ONLY SPECIFIED GREEN MACHINE BLADES.**

**KEEP BYSTANDERS AWAY FROM WORK AREA AT ALL TIMES.**

---



P.O. BOX 560, LONG BEACH, CALIFORNIA 90801-0560

20710 S. ALAMEDA ST., LONG BEACH, CALIFORNIA 90810 • (213) 603-9888 • TELEX 696396

GM908 11-89

## FORWARD

We are pleased that you have chosen a Green Machine product to assist you with your work. Your Green Machine product was assembled using the latest manufacturing methods and materials to bring you a product of the highest quality.

This Owner's Manual is provided to aid you in the proper assembly and the safe, reliable operation of your new Green Machine. Read it and become thoroughly familiar with the proper operating procedures **before you first use this product**. Make sure anyone who operates your Green Machine product is fully acquainted with the proper operating procedures. Careful assembly, safe operation and proper maintenance in accordance with this Owner's Manual will provide you with maximum performance and product life.

## SAFETY AWARENESS

Whenever you see the symbols shown below, be sure to read and understand their instructions! Always follow safe operating and proper maintenance practices.



**WARNING:** This warning symbol identifies special instructions or procedures which, if not correctly followed, could result in personal injury or loss of life.

**CAUTION:** This caution symbol identifies instructions or procedures which, if not strictly observed, could result in damage to or destruction of equipment.

**NOTE:** Indicates points of particular interest for more efficient and convenient operation.

**IMPORTANT:** Each Power Unit and all attachments are labeled with a serial number. During use of the unit there's a possibility of these numbers being scratched, destroyed or in some other means made illegible. For your convenience HMC has provided a space on the front page of this manual in which to record your serial numbers. Please record your numbers in the spaces provided; this will speed up ordering parts for your unit and/or reordering a new attachment from your retailer, distributor, or HMC Factory Service Center.

All information contained in this manual is based on the latest product information available at the time of publication. The right is reserved to make changes at any time without prior notice and without incurring an obligation to make such changes to products manufactured previously. See your authorized Green Machine Dealer for the latest information on product improvements incorporated after this manual was issued.

## 2130 STRINGTRIMMER/BRUSH CUTTER

Model 2130 Stringtrimmer/brush cutter designed for professional gardener users as well as homeowners with large acreage. It can also function as a tree pruner cutting branches up to 3" in diameter. From yardwork to professional gardener, the 2130 "Panther" meets the demands.

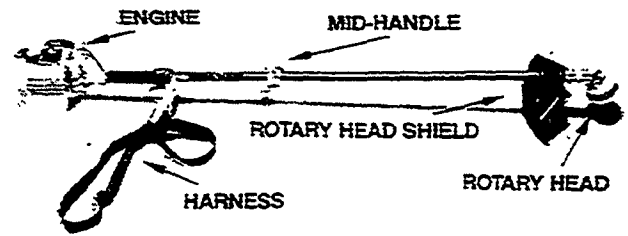

### 1. ASSEMBLY (Figure 1)

- Insert shaft into drive end (clutch housing) of engine as far as it will go.
- Align cutting head at end of shaft so it is parallel with bottom of engine (gas tank).
- Install bolt, washer and nut and tighten until shaft is secure.

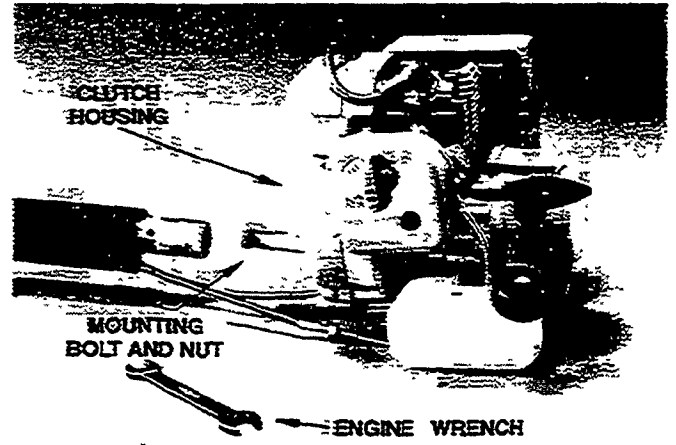

Figure 1

### 2. INSTALLING MID-HANDLE (Figure 2)

- Snap mid-handle over shaft tube below harness hanger (top of handle should angle back toward engine).
- Install bolt, washer, and wing knob (Figure 2).
- **Note:** Handle may be repositioned for best balance and comfort.

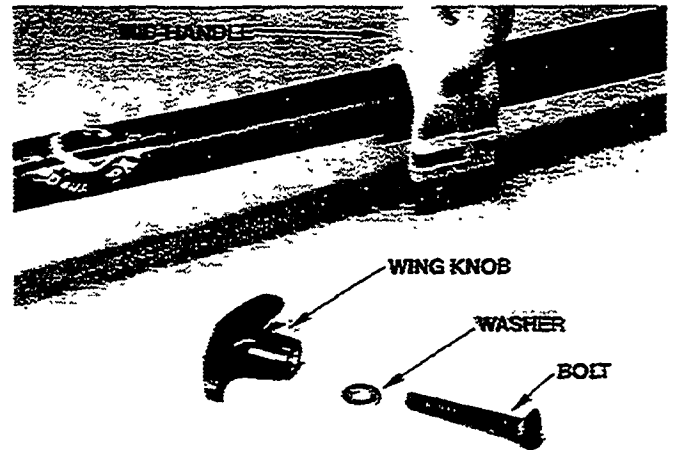

Figure 2

### 3. INSTALLING THROTTLE CABLE (Figure 3)

- Thread nut over end of throttle cable tube.
- Slip threaded end of throttle cable tube into loop on engine housing.
- Thread second nut over end of throttle cable tube, securing tube to the loop.
- Open throttle as shown (Figure 3), and hook the end of the throttle cable to the carburetor.
- Adjust the bolts so that there is 1 to 2 MM (Approx. 1/16") end play in cable tension when the trigger is closed.



Figure 3





## WARNING

**BLADE COASTS AFTER THROTTLE RELEASE**

WITH PROPER RPM ADJUSTMENT BLADE COULD COAST UP TO 15 SECONDS

**WARNING:** THE COASTING BLADE COULD INJURE YOU OR OTHERS

**HAZARD ZONE FOR THROWN OBJECTS IS 30 FEET**

BLADE AND/OR TRIMMER LINE CAN THROW OBJECTS VIOLENTLY

YOU OR OTHERS CAN BE BLINDED OR INJURED

WEAR EYE AND LEG PROTECTION

BLADE CAN THRUST VIOLENTLY AWAY FROM MATERIAL IT CAN NOT CUT

BLADE THRUST CAN CAUSE AMPUTATION OF ARMS OR LEGS

KEEP PEOPLE AND ANIMALS 50 FEET AWAY

## 2130 STRINGTRIMMER/BUSH CUTTER

### 1. ASSEMBLY

- Using the tools shown in (Figure 4), remove the bolt (left hand thread), star washer, and flat washer at the bottom of the gearcase.

**Note:** Save bolt and washers as they are needed when using brush or saw blades.

- While holding holder (B) with large spanner wrench, thread rotary head onto gearcase as shown in (Figure 5). Tighten rotary head as tight as possible by hand.

**CAUTION:** Never operate without blade guard/head shield in place and keep bystanders at least 50 ft. away.

- Install the blade guard/head shield using the hardware supplied (Figure 6).

- Note:** The flat washers must be installed on the bottom side of guard.

- To install brush or saw blades:  
Remove bolt (LH), star washer and small flat washer at the bottom of gear case (Figure 7).

- Remove holder (B) and place blade on holder (A) making sure that arbor hole in blade is centered on the arbor embossment on holder (A).

- Install holder (B) making sure that the splines line up and holder is completely seated.

- Re-install small flat washer, star washer, and bolt (Note bolt is left hand thread) and is turned counterclockwise to tighten (Figure 7).

#### • Special Note

Take special care when installing blades, as the cutting edge and/or points of the blade are very sharp. Make sure tools used are properly seated on their respective bolt or holder, and you have a firm grip on the tools.

- The blade rotation is clockwise (when viewing from below) so cutting edge of blades must face in that direction.

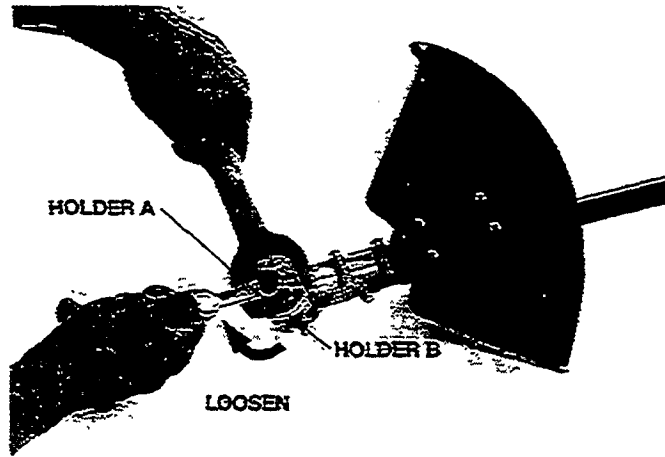

Figure 4

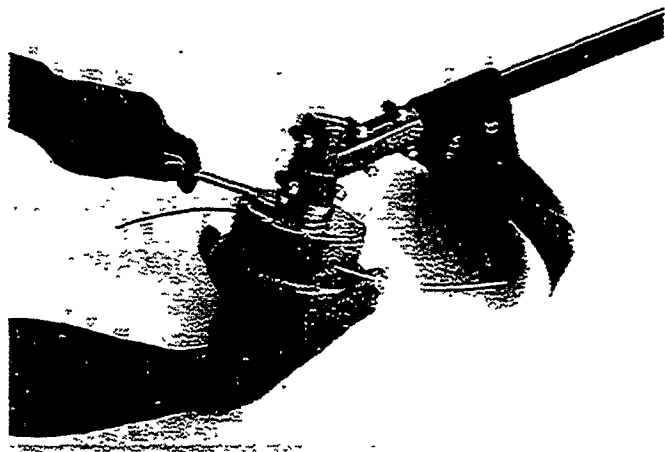

Figure 5

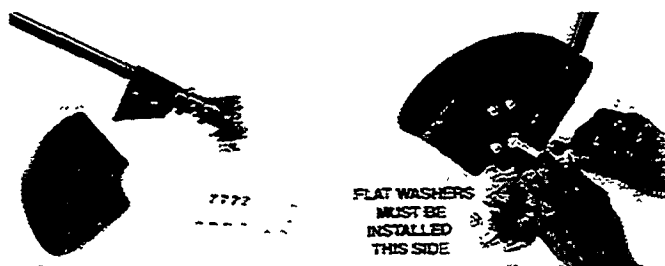

Figure 6

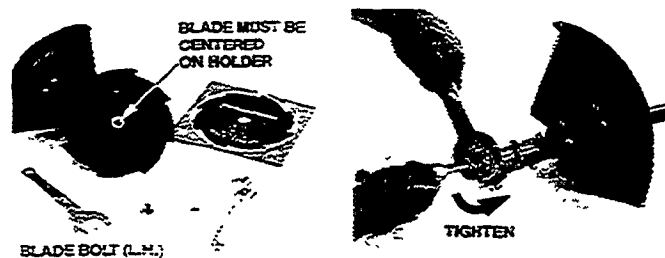

Figure 7

! **WARNING** !

BLADE COASTS AFTER THROTTLE RELEASE

WITH PROPER RPM ADJUSTMENT, BLADE COULD COAST UP TO 15 SECONDS

**WARNING:** THE COASTING BLADE COULD INJURE YOU OR OTHERS

HAZARD ZONE FOR THROWN OBJECTS IS 50 FEET

BLADE AND/OR TRIMMER LINE CAN THROW OBJECTS VIOLENTLY

YOU OR OTHERS CAN BE BLINDED OR INJURED

WEAR EYE AND LEG PROTECTION

BLADE CAN THRUST VIOLENTLY AWAY FROM MATERIAL "CAN NOT CUT"

BLADE THRUST CAN CAUSE AMPUTATION OF ARMS OR LEGS

KEEP PEOPLE AND ANIMALS 50 FEET AWAY



**WARNING:**  
**Blade Use**

- Extreme care must be taken when using brush or saw blades to insure safe operation.
- When the blades hit a hard object a serious sideward kickback could occur.
- Never attempt blade work without first inspecting and clearing the area of unseen objects such as concrete, fencing, wire, wood, metal, etc.
- Never use blades near sidewalks, fencing, posts, buildings or other immovable objects.
- Use the brush and saw blades only for that cutting which is recommended. Brush blade-brush up to 3/8 in. diameter. Saw blade-tree limbs up to 3 in. diameter.
- Never use a blade after hitting a hard object without first inspecting it for bent cutters and cracks. Do not use if either condition is found.
- Use only Green Machine saw No. 92130 or No. 92140 blade. Do not use crosscut blade.
- Always use shoulder harness whenever blades are used, No. 257601.
- Have professional re-sharpen your blade or saw.

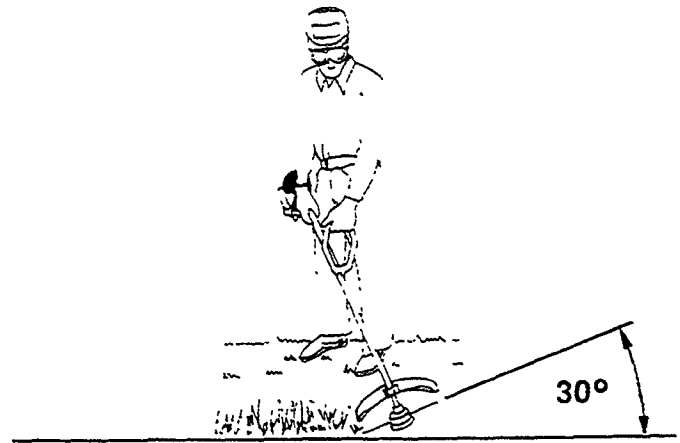

Figure 8

## 2. CUTTING TECHNIQUE

- Hold unit so the rotary head is at an approx. 30° angle to the ground (Figure 8).
- Allow the very tip of the line to do the cutting.
- Always operate unit with the correct line size (.080 dia.).
- Always use correct line length (max. 6.0, min. 3.0 inches).
- **Note:** As the cutting line wears down, engine speed (RPM) will increase. Allowing engine to run at high RPM (3 inch cutting line or less) for a prolonged period will shorten engine life.
- Cut from left to right with the engine at full throttle, so that clippings will be thrown away from you (Figure 8).

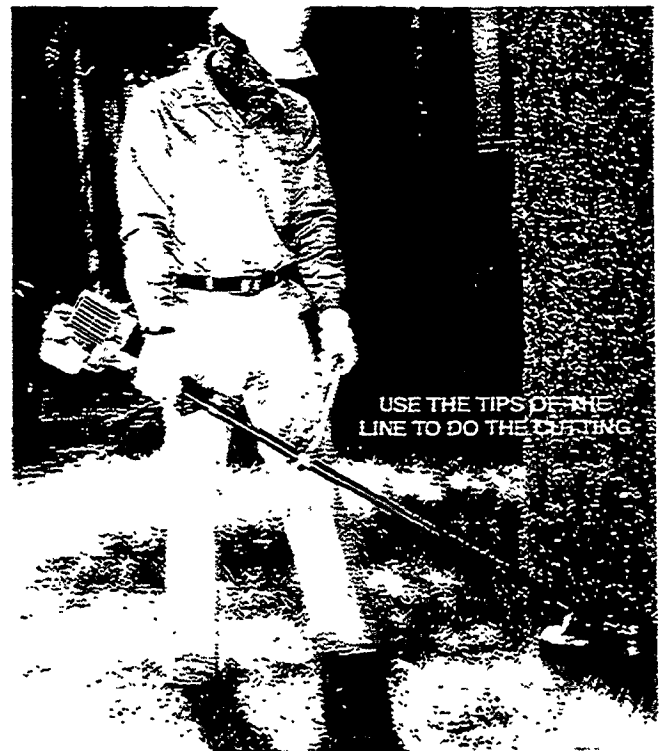

Figure 9

## 3. EXTENDING LINE

- As you perform your trimming tasks, the cutting line will wear shorter. It may be extended automatically, with engine running, or manually, with engine stopped.
- **Engine running:** (at full speed) lightly tap (Do not pound) the rotary head on the ground. Line will advance approximately 1/2 inch per tap.
- When tapping for line, it should be done on bare ground or a hard surface.

- **Note:** The cutting line will not extend automatically if the line is worn too short. You should extend the line before it is worn to 3 inch length.
- **Engine stopped:** Line can be advanced manually, by turning the unit over so you are facing the bottom of the rotary head. While pulling outward on one of the cutting lines, push in on the spool. When the line stops, release the spool and continue pulling the line. Keep repeating this procedure until the desired amount of line is extended.
- **Note:** Never operate trimmer with more than six (6) inches of line extended outside the rotary head. Excessive line length can often be identified by low engine RPM when throttle lever is in the full throttle position.

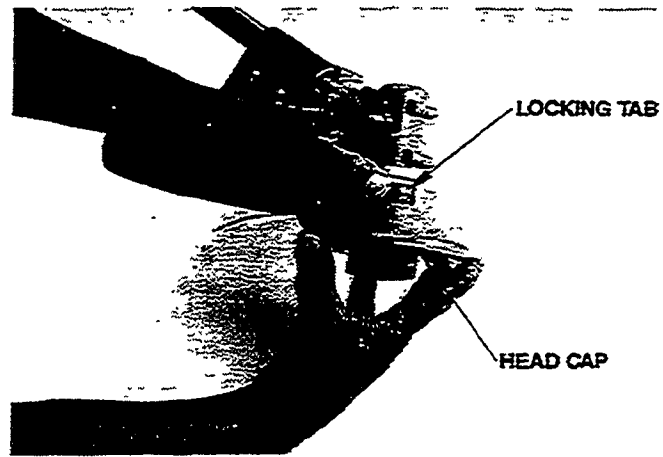

Figure 10

#### 4. TO REPLENISH LINE SUPPLY

- Push in one of the locking tabs, releasing it from its notch (**Figure 10, 11**), and pull on the rotary head cap.
- Once both locking tabs have released, lift rotary head cap off and remove spool.
- Cut a length of cutting line that is .080 diameter and approximately 30 ft. long.
- Loop line through holes in spool and make certain that both lines are even (**Figure 11**).
- Hold spool as shown (**Figure 11**) and feed line on neatly by rotating the spool counterclockwise.
- **Note:** Do not wind line on, rotate the spool.
- **Note:** Clean all dirt, dust, and grass out of rotary head, spool and head cap before reassembling.
- Once the line is on the spool, hold spool as shown in (**Figure 12**) and insert lines in their respective line-savers and place spool back onto the rotary head.
- **Note:** Be certain that lines do not become trapped under the spool (**Figure 13**).
- Re-install rotary head cap by aligning locking tabs with their notches and pushing cap down until both locking tabs are securely locked (**Figure 14**).
- Before operating unit check by advancing the line manually, making sure lines are not trapped, and rotary head is assembled correctly.

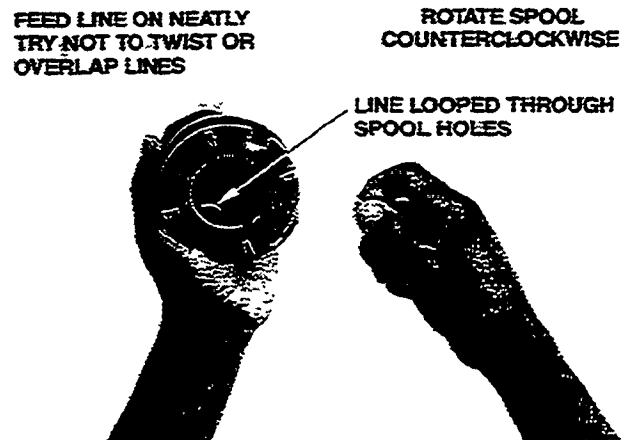

Figure 11

#### 5. MAINTENANCE

- After each 10 hours of use, the gearcase must be greased by adding one (1) to two (2) pumps with a grease gun. If excessive grease is pumped into the gearbox, the hydraulic pressure will move the liner in the tube. To avoid this, remove the gearbox from the tube by loosening the two (2) clamp screws and backing out the anti-rotation screw; next, pump in the grease until it is forced out of the pinion gear inside the tube cavity (**Figure 15**). Reassemble the tube and gearbox in reverse order.

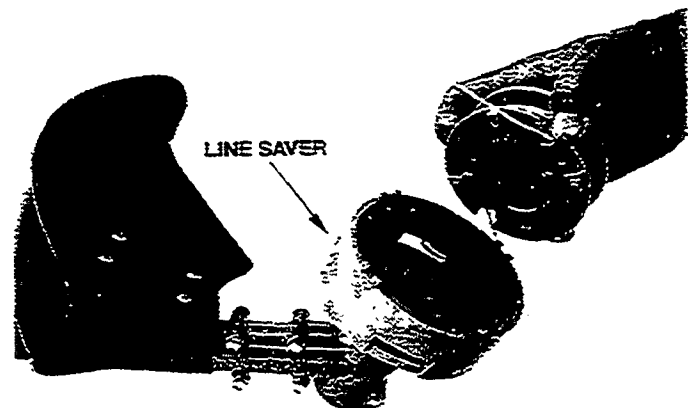

Figure 12

- The flex cable is lubricated during assembly at the factory and needs no scheduled maintenance. However, if it is removed, regrease and install exactly as it was removed. Do not reverse. Use grade no. 2 grease.



**SAFETY:**

- Before each use inspect your GREEN MACHINE for loose, damaged, broken or missing parts. Correct before use.
- Always wear approved safety goggles.
- Do not wear loose fitting clothes.
- Always wear long pants.
- Never operate unit while bare foot or wearing sandals.
- Always cut from left to right.
- Always keep all bystanders a minimum of 50 ft. away at all times.
- When using brush or saw blades, always use genuine GREEN MACHINE blades.
- Always use blade guard/head shield.
- Never use any type of wire in place of the nylon string

**6. SUPPLYING FUEL**

- Fill the fuel tank with fuel to  $\frac{7}{8}$  full, using a mixed fuel of gasoline and 2 cycle air cooled engine oil.
- HMC recommends using **One-Mix**® in its Green Machine products. When using **One-Mix**®, it is not necessary to figure fuel mixture (oil to gasoline) ratio. Simply mix one packet of **One-Mix**® to one U.S. gallon of regular leaded or unleaded gasoline.
- **Special Note: Never use gasohol. If gasohol is used, engine warranty will be voided. To test for alcohol content in gasoline, an inexpensive gasohol tester kit is available, order part #27339.**
- If you do not wish to use **One-Mix**®, you must then make certain of a proper oil to gasoline ratio.
- When any oil other than **One-Mix**® is used, you must use a ratio of 25:1 (25 parts of gasoline to one part of oil) i.e., 5.12 oz. of oil mixed in one U.S. gallon of gasoline.



**WARNING:**

1. Never smoke when refueling or refuel in an area with open flame (such as water heater pilot light). Gasoline vapors spread rapidly and are highly explosive.
2. Always stop engine and wait for it to cool before refueling.
3. Clean up any spills and dispose of clean-up materials.
4. After refueling, move to another area for starting.
5. Never over fill. Fill tank only  $\frac{7}{8}$  full to avoid spillage.

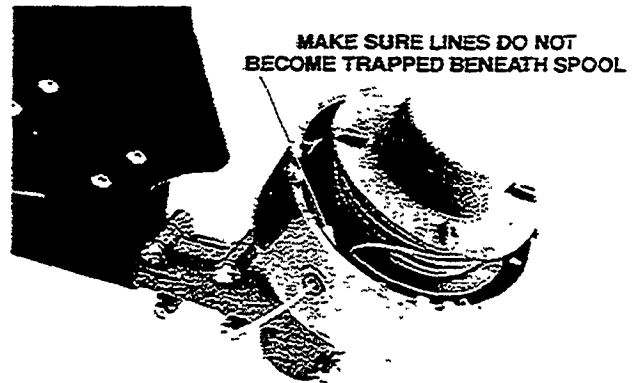
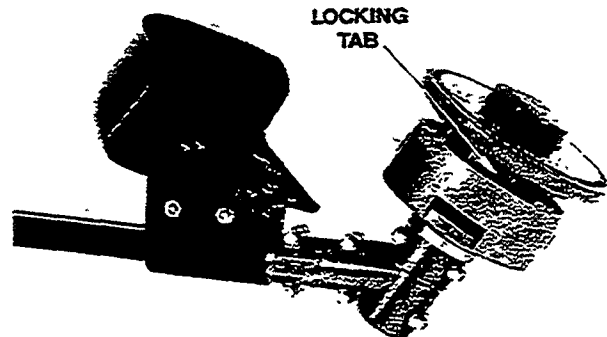

Figure 13



**NOTE: MAKE SURE BOTH LOCKING TABS ARE SECURELY LOCKED.**

Figure 14

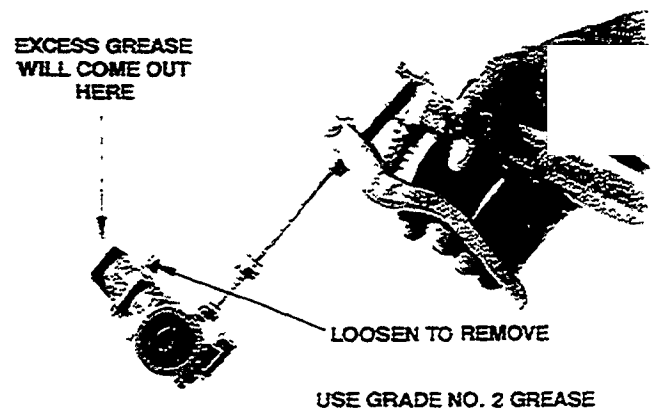

Figure 15

- Always thoroughly mix the oil and the gasoline by mixing vigorously to insure thorough blending. There are countless small 2 cycle engines destroyed each year because of improperly mixed oil and gasoline.

Econo Pack	Mixes 1 Gallon of Fuel
Pro Tube	Mixes 1 Gallon of Fuel
8 oz. bottle	Mixes 2 1/2 Gallons of Fuel
32 oz. bottle	Mixes 10 Gallons of Fuel
128 oz. bottle	Mixes 40 Gallons of Fuel



Figure 16

## 7. INSPECTION

- Always inspect all fasteners for tightness and/or missing parts. Tighten or replace before use.
- Read and understand all safety and operating instructions before use.
- Check for any fuel leaks. If any, correct before use.
- Make sure all air passages are free of dirt, dust, or any other foreign material.
- Inspect air cleaner for cleanliness.

## 8. STARTING THE ENGINE, WHEN COLD (INITIAL ENGINE STARTING)

- Slide stop switch (on top of trigger) to run position (towards engine).
- Push the primer pump until fuel flows through the clear plastic return line (Figures 17 & 18).
- Place choke lever in the closed position (Figure 18).
- Lock throttle lever in the start position as shown in (Figure 19).
- Pull starter rope slowly until engine compression is felt (Figure 19). Pull the starter in short rapid strokes until engine starts.
- Avoid pulling the rope to its full extension as starter failure could result.
- Once the engine has started, slowly return the choke lever to its open position.
- Return the throttle lever to its idle position.
- Always allow the engine to run 1 to 2 minutes at idle for warm up before starting work.
- **Special Note:**  
Never start unit on the ground by using your foot, knee, or hand, to push down while pulling up on the rope (Figure 20). This will cause the tube & cable to become bent and then break. Never allow the starter rope to snap back.

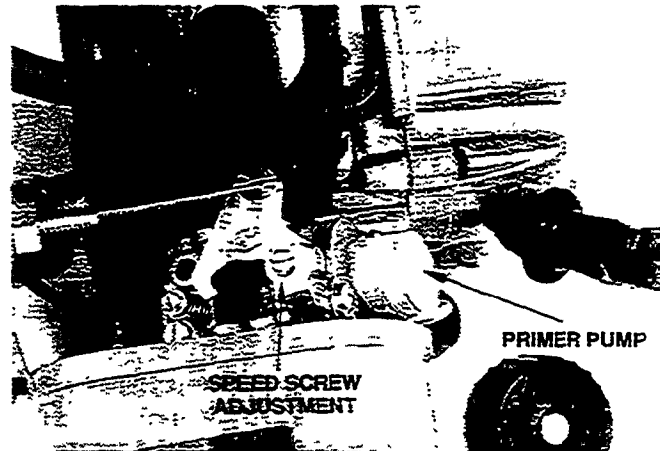

Figure 17

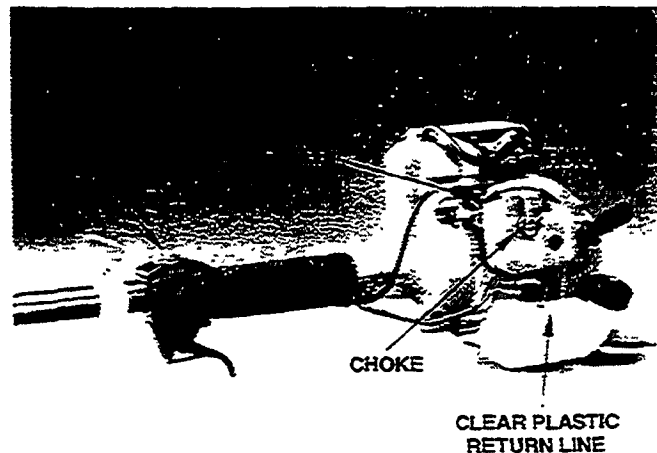

Figure 18



### When Warm (Restarting Engine)

- Hold throttle lever in the open position.
- Place choke lever in its open position.
- Pull starter rope as outlined in "Starting When Cold."
- **Note:** If engine fails to start, push primer until fuel appears in clear plastic return line.

## 9. STOPPING ENGINE

- Return throttle lever to its idle position, and allow the engine to idle for a short period (approx. 30 sec.). This allows the engine to cool down.
- Push stop switch to "Stop" position (toward the cutting head). Be sure to return the stop switch to the run position before trying to start unit.
- **Note:** Except for emergencies, avoid stopping engine while it is running at high speed, avoids overheating the engine.

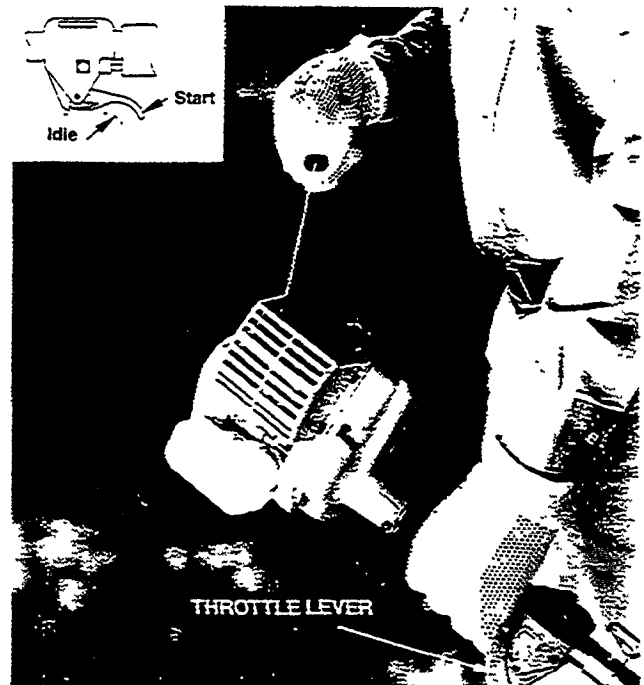

Figure 19

## 10. ADJUSTING ENGINE

- Your Green Machine engine has been adjusted at the factory for optimum performance and fuel consumption, and no further adjustment should be required. However, because of varying atmospheric and climatic conditions, some minor adjustment may be needed for your area.
- Adjusting idle speed should always be done with a tachometer to insure proper idle speed (2,800 to 3,300 rpm). If a tachometer is not available, the idle speed may be adjusted as follows (**Figure 17**):
  1. Turn idle speed screw clockwise until cutting head or lower drive begins to move.
  2. Turn idle speed screw counterclockwise until lower drive stops.
  3. Turn idle speed screw approximately  $1/4$  to  $3/4$  turn further counterclockwise.
- If the engine does not idle properly after this adjustment, contact your nearest Green Machine dealer for service.
- Condition of the air cleaner is very important to the operation and life of the engine, and also has a major effect on carburetor adjustments. The air cleaner should be checked for cleanliness before each use, and before making any carburetor adjustment.

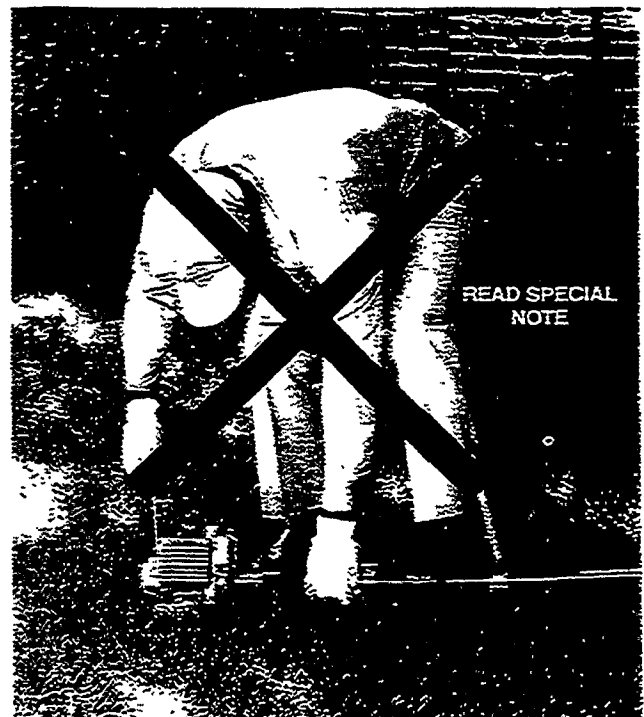

Figure 20

## 11. MAINTENANCE

### Daily

- Carefully inspect complete unit for damaged, loose or missing parts. Correct before use.

- Carefully inspect for any fuel leaks. Correct immediately.
- Check air cleaner for cleanliness.
- Remove all dust, dirt, and grass from the entire unit after each use.  
**30-Hour Service, or Once a Week for Professional Gardener use.**
- All items under daily service plus:
- Remove, clean, and regap spark plug (0.025 in.). When replacing spark plug, use **Champion DJ8J** or **NGK BM6F**.
- Clean and service air filter (after cleaning put small amount of engine oil on sponge and squeeze out excess) (**Figure 21**).
- Check fuel filter in tank and clean if needed (**Figure 21**).
- Remove cylinder cover and clean out all dust, dirt, and foreign material.

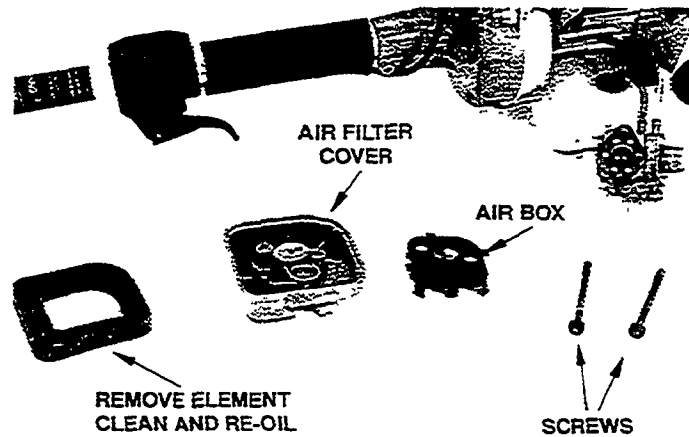

Figure 21



**SAFETY:**

- Before each use always inspect your Green Machine for loose, missing, damaged or broken parts. Correct before using.
- Always wear approved eye protection (safety goggles).
- Do not wear loose fitting clothes while operating unit.
- Never operate unit while barefoot or wearing sandals.
- Never operate unit without shields or guards in place and in good working order.
- Use only genuine Green Machine blades and rotary heads.
- Never use any type of wire in place of the nylon string.
- Never touch engine or muffler during operation, or immediately after shutdown.
- Never touch spark plug, ignition plug cap, or high tension wire while engine is running.
- Always make sure engine is securely mounted to driveshaft before each use.
- Always check for any fuel leaks before each use and correct before use.
- Never operate unit indoors or in an enclosed area.
- Keep bystanders away from work area at all times.
- Your Green Machine is not a toy. Do not allow children to play with it or use it.

**GREEN LINE™** nylon cutting line is manufactured from the highest quality nylon available, produced under very strict quality control standards to provide you with the longest wearing cutting line available.

For over 15 years, **GREEN LINE™** nylon cutting line has been and continues to be the preferred cutting line of commercial users (Landscapers, Gardeners, Cities, Golf Courses, etc.), because of its excellent wearing ability and value.

### Performance Tips

**Always check your owner's manual for the proper line size and length**

- ✧ Larger line sizes or excessive length of line will reduce the cutting head speed and performance and may overload, overheat and/or damage your trimmer. This may void your manufacturer's warranty.

### Line Life Tips

Retaining line moisture is important to receive maximum line life.

- Store extra line in a cool, moist location. A hot dry area will dry the line out and shorten its life.
- If the line dries out, the cutting tips will split and fray. If this happens, soak the line in water overnight and it will regain its moisture.
- By keeping up the moisture content in cutting line, you may experience as much as a 300% increase in line life.



# WARNING



READ OPERATOR'S MANUAL FURNISHED WITH TRIMMER AT TIME OF PURCHASE.  
FOLLOW ALL WARNINGS & INSTRUCTIONS — FAILURE TO DO SO  
CAN RESULT IN SERIOUS INJURY!

HAZARD ZONE FOR THROWN OBJECTS IS 50 FT.

WEAR EYE AND LEG PROTECTION

TRIMMER LINE THROWS OBJECTS VIOLENTLY

KEEP PEOPLE AND ANIMALS 50 FEET AWAY

# 50,000 Dinosaurs gave their lives for ONE MIX®. In their honor, we make it the best it can be.



One Mix® is simply the best 2-cycle engine oil you can buy. Formulated for all 2-cycle vehicles at one mixing ratio, One Mix® is available in pre-measured packets for one gallon of gasoline up to 55 gallon drums. Pure and simple.

A PRODUCT OF  
**HMC**

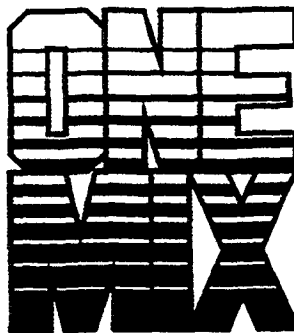

Don't let  
your yard-care  
equipment  
become  
extinct!



P.O. BOX 560, LONG BEACH, CALIFORNIA 90801-0560  
20710 S. ALAMEDA ST., LONG BEACH, CALIFORNIA 90810 • (213) 603-9888 • TELEX 696396