



## Wiring Diagram & Schematic SAFETY WARNINGS

### Safety Alert Symbols

The safety alert symbol (⚠) is used to identify hazards that can result in personal injury. A signal word (**DANGER**, **WARNING** or **CAUTION**) is used with the alert symbol to indicate the potential severity of injury. In addition, a hazard symbol may be used to represent the type of hazard.





**⚠ DANGER:** Indicates a hazard which, if not avoided **will result in death or serious injury**.

**⚠ WARNING:** Indicated a hazard which, if not avoided **could result in death or serious injury**.

**⚠ CAUTION:** Indicates a hazard which, if not avoided **might result in death or serious injury**.

**CAUTION:** When used without the alert symbol, indicates a situation that could result in damage to equipment or components.

**HAZARD SYMBOLS AND MEANINGS**

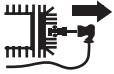
 Explosion	 Fire	 Shock
 Entanglement	 Disconnect Spark Plug	

WD-SCH-01

**⚠ DANGER**

 Generators produce powerful voltages. Failure to isolate generator from power utility can result in death or injury to electric utility workers due to backfeed of electrical energy.

- When testing generators used for backup power, notify utility company.

WD-SCH-05

**CAUTION:** The measuring equipment used in troubleshooting this equipment should be of industrial quality and should have the sensitivity to measure electronic values to the third decimal. Its accuracy should conform with acceptable industry tolerances. Ensure that all specified tools and/or equipment are available before attempting to troubleshoot.

WD-SCH-03

**⚠ DANGER**

 Physical contact with energized electrical components will result in dangerous and possibly fatal electrical shock.

- Do not touch bare wires or receptacles.

WD-SCH-04

**⚠ CAUTION**

 These wiring diagrams and schematics are intended for use by trained and qualified electrical service technicians who are working in a properly equipped service environment. Familiarity with the proper method of using tools, measuring equipment and service procedures is essential to performing successful troubleshooting and repair of this equipment.

- Only qualified electrical technicians should attempt to service this equipment.

WD-SCH-02

**⚠ WARNING**

 Accidental starting of the unit may cause entanglement or electrocution.

- Where applicable, disconnect the negative (-) battery terminal.
- Disconnect the spark plug wire.
- Remove the control panel fuse when available.

WD-SCH-07

3250 Watt Portable Generator

**SCHEMATIC**

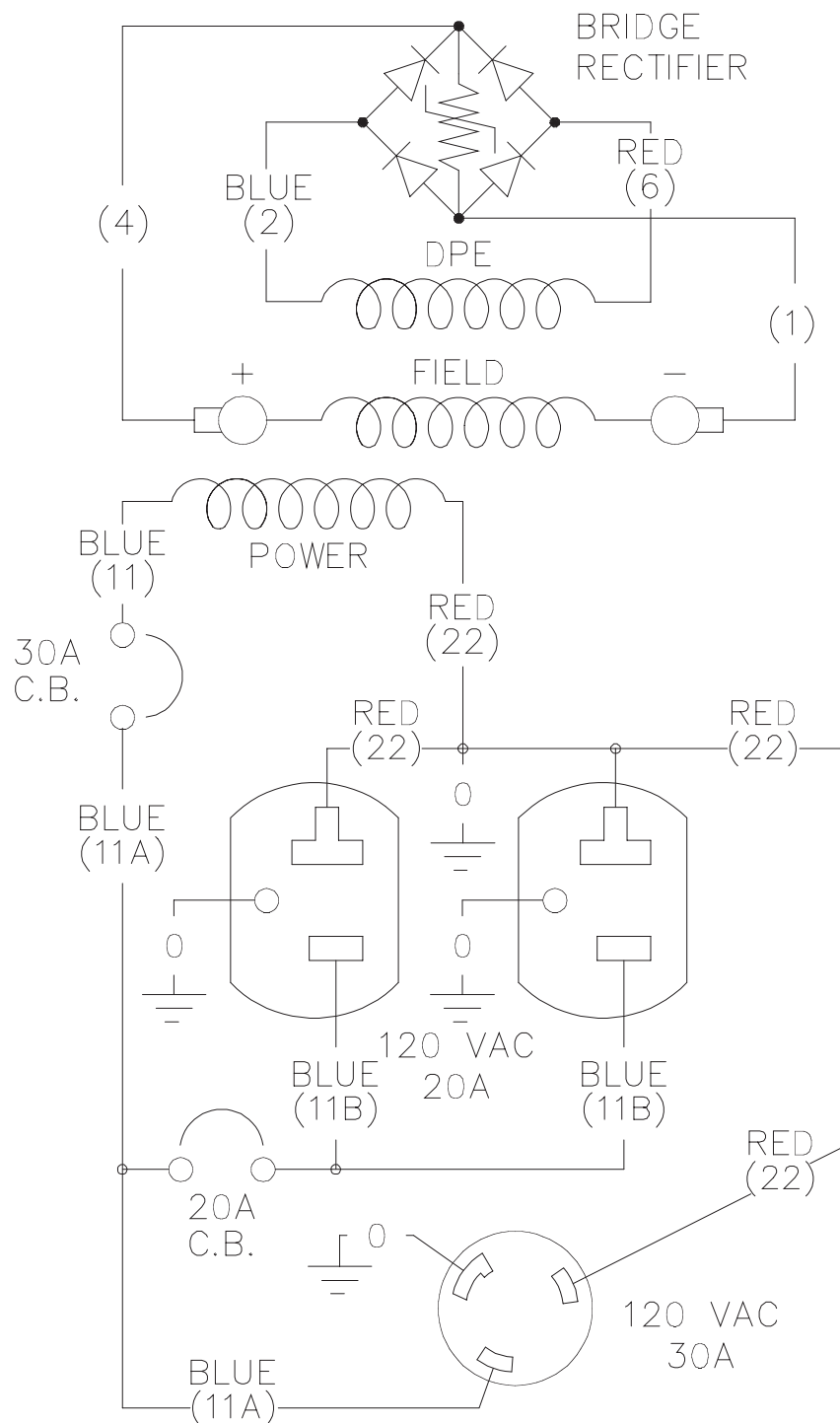

3250 Watt Portable Generator

WIRING DIAGRAM

