

For Serial Nos.
600,000 & Higher

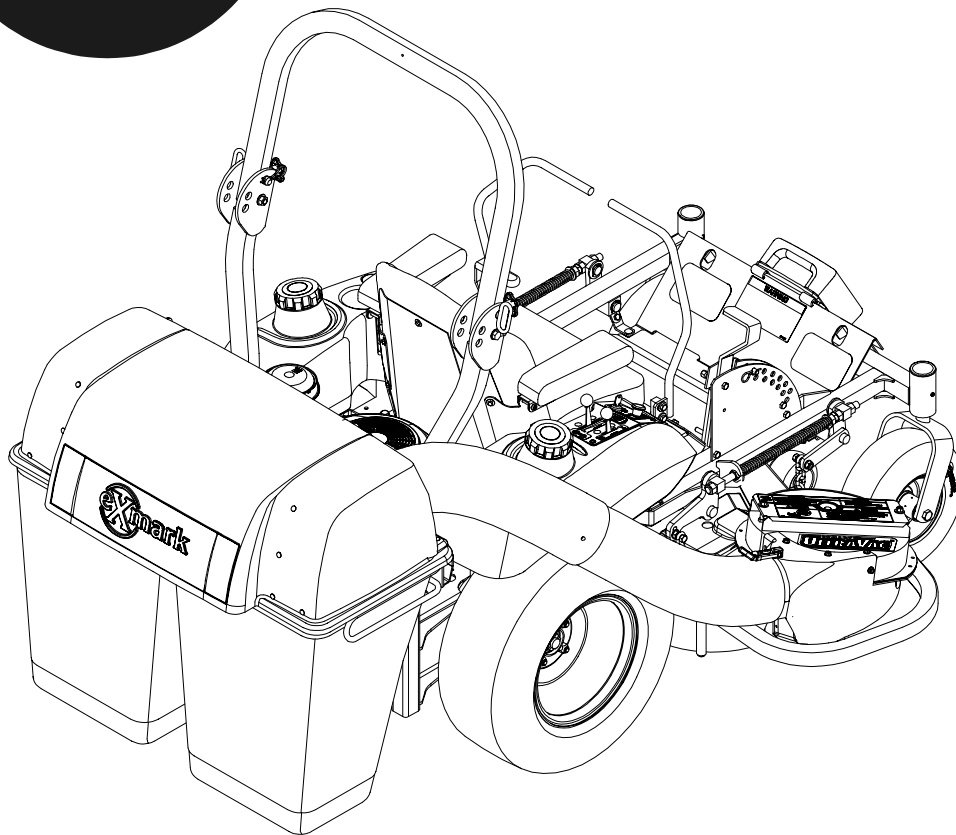

ULTRA VAC™

LAZER Z® HP MODELS



OPERATOR'S MANUAL

CONGRATULATIONS on the purchase of your new Exmark equipment. This product has been carefully designed and manufactured to give you a maximum amount of dependability and years of trouble-free operation. If additional information is needed, or should you require trained mechanic service, contact your authorized Exmark equipment dealer or distributor. If you need to order replacement parts from your dealer, always give the model number and serial number of your equipment as well as the part number, description and quantity of the part needed.

The Serial No. plate is located on the front mount of the hopper assembly. For ease of ordering and reference, we suggest that you record the information requested in the following identification table.

Place Model No. and Serial No. Label Here (Included in Literature Pack) or Fill in Below
Model No. _____
Serial No. _____

Date Purchased _____

 WARNING 	
POTENTIAL HAZARD	
◆ This product is a piece of power equipment.	
WHAT CAN HAPPEN	
◆ Failure to follow safe operating practices can result in serious operator injury or even death.	
HOW TO AVOID THE HAZARD	
◆ Keep all shields, guards and safety devices (especially the grass discharge system) in place and in proper working condition.	
◆ Stop engine and wait for all moving parts to stop. Remove spark plug wire(s) or remove key before adjusting, servicing, or performing maintenance.	
◆ If mower deck or blower becomes clogged, stop engine and wait for all moving parts to stop. Remove spark plug wire(s) or remove key before cleaning blockage.	
◆ Keep hands, feet and clothing away from power driven parts.	
◆ Keep off mower unless seat platform is provided.	
◆ Keep others off mower.	

Exmark reserves the right to make changes or add improvements to its products at any time without incurring any obligation to make such changes to products manufactured previously. Exmark, or its distributors and dealers, accept no responsibility for variations which may be evident in the actual specifications of its products and the statements and descriptions contained in this publication.

EXMARK PARTS PLUS® PROGRAM

EFFECTIVE DATE: September 1, 1995

Program

If your Exmark dealer does not have the Exmark part in stock, Exmark will get the parts to the dealer the next business day or the part will be FREE* Guaranteed!!

How the Program Works

1. If dealer does not have part in stock for a "down" unit at the time of request by customer, the dealer contacts his distributor by 1:00 p.m., local time, and requests Exmark Parts Plus® shipment of six (6) line items or less.
2. Distributor ships part(s) to dealer or customer, as requested by dealer, same day, overnight UPS Distributor bills dealer for part and freight charges where applicable.
3. If distributor does not have the part(s) in stock to satisfy Exmark Parts Plus® order, he contacts Exmark by 3:00 p.m., central time, with an Exmark Parts Plus® order of six (6) line items or less.
4. If order is received by 3:00 p.m. central time, Exmark ships part(s) direct to dealer or customer, as requested by distributor, same day, overnight UPS Exmark bills the distributor for parts and shipping charges, where applicable.
5. The customer pays for the part and freight if it is shipped under the Exmark Parts Plus® and if it arrives in accordance to the program.
6. Who pays for the part and freight if it fails to arrive overnight in accordance to the program?
 - A. Under any circumstance the customer does not pay.
 - B. If the part does not arrive overnight due to:
 1. The dealer not submitting the Exmark Parts Plus® order to his Exmark distributor by 1:00 p.m., the dealer pays for the part and freight.
 2. The Distributor being unable to ship the part the same day or not submitting the Exmark Parts Plus® order to Exmark by 3:00 p.m., central time, the Distributor pays for the part and freight.
 3. Exmark being unable to ship the part and the Exmark parts order is received by 3:00 p.m., central time, Exmark pays for the part and freight.
 4. If the part does not arrive overnight due to the shipper (UPS), the shipper pays for the freight and Exmark pays for the part.

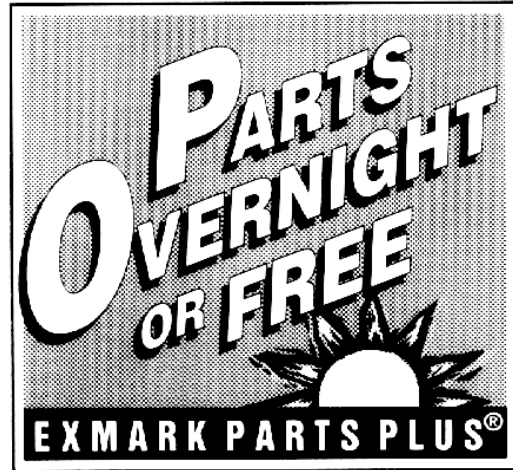

The following restrictions apply -- The Exmark Parts Plus® Program is available only through participating Exmark Dealers and applies only to orders submitted on this program Monday through Thursday. Parts Plus service is available only in the 48 contiguous United States. UPS has initiated a Saturday delivery program to many areas of the continental United States and can be requested for an overnight shipment on Friday to be delivered Saturday. The next day air charge, plus the Saturday delivery fee will be the responsibility of the purchaser. Exmark Mfg. will assume no responsibility for Saturday delivery shipments. To qualify, all Exmark Parts Plus® orders must be received by Exmark by 3:00 p.m., central time. Orders must be six (6) line items or less. Exclusions from the Exmark Parts Plus® Program are: Any wholegood or accessory in its entirety, engines and engine replacement parts, 5-speed Peerless transmissions and 5-speed transaxles, hydraulic or hydrostatic wheel motors, cutter decks and engine decks or any item exceeding United Parcel Service size and weight restrictions.

Due to UPS restrictions, aerosol spray paint is considered a hazardous material and cannot be shipped via UPS next day or Second Day Air.

Exmark Manufacturing stocks a limited supply of parts for transaxles, pumps and wheel motors. These parts can be ordered for Next Day Air shipment but will not be guaranteed per the Parts Plus Program.

OPERATOR'S MANUAL

This manual contains assembly, operating, maintenance, adjustment and safety instructions for your Exmark Ultra Vac.

BEFORE OPERATING YOUR ULTRA VAC, CAREFULLY READ AND UNDERSTAND THIS MANUAL AND THE OPERATOR'S MANUAL FOR YOUR MOWER IN THEIR ENTIRETY.

By following the operating, maintenance and safety instructions, you will prolong the life of your Ultra Vac, maintain its maximum efficiency and promote safe operation.

If additional information is needed, or should you require trained mechanic service, contact your authorized Exmark equipment dealer or distributor.

All Exmark equipment dealers and distributors are kept informed of the latest methods of servicing and are equipped to provide prompt and efficient service in the field or at their service stations. They carry ample stock of service parts or can secure them promptly for you from the factory.

All Exmark parts are thoroughly tested and inspected before leaving the factory; however, attention is required on your part if you are to obtain the fullest measure of satisfaction and performance.

TABLE OF CONTENTS

<u>Description</u>	<u>Page</u>
1. SAFETY	
1.1 Safety Alert Symbol	1
1.2 Training	1
1.3 Preparation	1-2
1.4 Operation.....	2-4
1.5 Safety Signs	4-5
2. SPECIFICATIONS	
2.1 Dimensions.....	6
2.2 Bagging System	6
3. OPERATION	
3.1 Pre-Start	6
3.2 Mowing	7
3.3 Bagger Removal for Side Discharge.....	7-9
3.4 Bagger Installation for Bagging.....	9
3.5 Transporting	9-11
4. MAINTENANCE	
4.1 Periodic Maintenance	11-13
5. TIPS AND TROUBLESHOOTING	14
6. WARRANTY	15

1. SAFETY

1.1 SAFETY ALERT SYMBOL

This SAFETY ALERT SYMBOL  is used both in this manual and on the machine to identify important safety messages which must be followed to avoid accidents. This symbol means:

ATTENTION! BECOME ALERT! YOUR SAFETY IS INVOLVED!

The safety alert symbol appears above information which alerts you to unsafe actions or situations and will be followed by the word **DANGER**, **WARNING**, or **CAUTION**.

DANGER: White lettering / Red background. Indicates an imminently hazardous situation which, if not avoided, **WILL** result in death or serious injury.

WARNING: Black lettering / Orange background. Indicates a potentially hazardous situation which, if not avoided, **COULD** result in death or serious injury.



CAUTION: Black lettering / Yellow background. Indicates a potentially hazardous situation which, if not avoided, **MAY** result in minor or moderate injury.

1.2 TRAINING

- 1.2.1 Regard the Exmark Ultra Vac as a piece of power equipment and teach this regard to all who operate this unit.
- 1.2.2 Before operating your Ultra Vac, carefully read and understand this manual and the operator's manual for your mower in their entirety. Familiarize yourself with the controls and the proper use of the equipment. If the operator(s) or mechanic(s) can not read English, it is the owner's responsibility to explain this material to them.
- 1.2.3 Do not allow operation of this machine by untrained personnel. Never allow children, teenagers, or people unfamiliar with these instructions to use the mower. Local regulations may restrict the age of the operator.
- 1.2.4 Avoid mowing while people, especially children, or pets, are nearby. Keep in mind that the operator or user is responsible for accidents or hazards occurring to other people or their property.

1.3 PREPARATION



- 1.3.1 Evaluate the terrain to determine what accessories and attachments are needed to properly and safely perform the job. Only use accessories and attachments approved by Exmark.
- 1.3.2 The use of personal protective equipment, such as (but not limited to) protection for the eyes, ears, feet, and head is recommended.





 CAUTION 	
POTENTIAL HAZARD	<ul style="list-style-type: none">◆ This machine produces sound levels in excess of 85 dBA at the operator's ear when in operation.
WHAT CAN HAPPEN	<ul style="list-style-type: none">◆ Exposure to sound levels of 85 dBA or above for extended periods of time can cause hearing loss.
HOW TO AVOID THE HAZARD	<ul style="list-style-type: none">◆ Wear hearing protection when operating this machine.

- 1.3.3 While mowing, always wear substantial footwear and long trousers. Do not operate equipment when barefoot or when wearing open sandals.
- 1.3.4 Thoroughly inspect the area where the equipment is to be used and remove all stones, sticks, wires, bones, and other foreign objects which may damage the equipment or cause personal injury to the operator or bystanders.



1.4 OPERATION

Although hazard control and accident prevention are partially dependent upon the design and configuration of the equipment, these factors are also dependent upon the awareness, concern, prudence, and proper training of the personnel involved in the operation, transport, maintenance, and storage of the equipment. It is essential that all Operator Safety Mechanisms be connected and in operating condition prior to use for mowing. Refer to the Operator's Manual for the mower for additional hazard control and accident prevention information.

 WARNING 	
POTENTIAL HAZARD	<ul style="list-style-type: none">◆ An uncovered discharge opening will allow objects to be thrown in operator's or bystander's direction. Also, contact with blade could occur.
WHAT CAN HAPPEN	<ul style="list-style-type: none">◆ Thrown objects or blade contact can cause serious injury or kill you or bystanders.
HOW TO AVOID THE HAZARD	<ul style="list-style-type: none">◆ Never operate mower unless discharge deflector, or entire grass collection system, or mulch kit is installed.

 DANGER 	
	POTENTIAL HAZARD <ul style="list-style-type: none"> ◆ There are rotating blades in the blower and under the mower deck.
	WHAT CAN HAPPEN <ul style="list-style-type: none"> ◆ Blade contact can cause serious operator or bystander injury or even death.
	HOW TO AVOID THE HAZARD <ul style="list-style-type: none"> ◆ Do NOT reach into Blower unless Rotation Indicator has Stopped. Disengage PTO, stop engine, remove key, WAIT FOR MOVING PARTS TO STOP. ◆ Never operate mower unless discharge deflector, entire grass collection system, or mulch kit is installed.

- 1.4.1 Use *EXTREME* caution when mowing and/or turning on slopes as loss of traction and/or tip-over could occur. The operator is responsible for safe operation on slopes.

 DANGER 	
POTENTIAL HAZARD <ul style="list-style-type: none"> ◆ Mowing on wet grass or steep slopes can cause sliding and loss of control. 	
WHAT CAN HAPPEN <ul style="list-style-type: none"> ◆ Wheels dropping over edges, ditches, steep banks, or water can cause rollovers, which may result in serious injury, death or drowning. 	
HOW TO AVOID THE HAZARD <ul style="list-style-type: none"> ◆ Do not mow slopes when grass is wet. ◆ Do not mow near drop-offs or near water. ◆ Do not mow slopes greater than 15 degrees. ◆ Reduce speed and use extreme caution on slopes. ◆ Avoid sudden turns or rapid speed changes. 	

- Use a walk behind mower and/or a hand trimmer near drop-offs, ditches, steep banks or water. This area can be dangerous, see Figure 1.

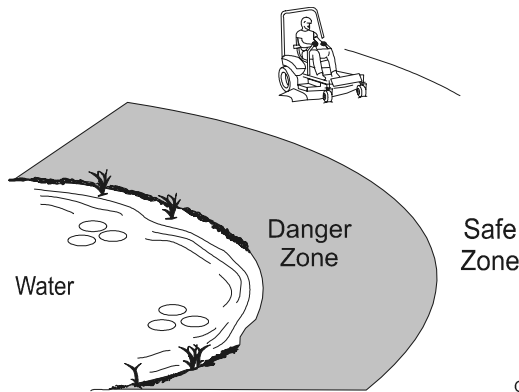

FIGURE1
SAFE ZONE FOR MOWING

- Progressively greater care is needed as the slope increases.
- Always avoid sudden starting or stopping on a slope. If tires lose traction, disengage the blades and proceed slowly off the slope.
- Avoid sudden starts when mowing uphill. Mower may tip backwards.
- Be aware that loss of traction may occur going downhill. Weight transfer to the front wheels may cause drive wheels to slip and cause loss of braking and steering.
- Watch for ditches, holes, rocks, dips, and rises that change the operating angle, as rough terrain could overturn the machine.
- Remove or mark obstacles such as rocks, tree limbs, etc. from the mowing area. Tall grass can hide obstacles.
- The operating characteristics of the machine will change with the Ultra Vac installed. The stability and traction of the machine will change as the Ultra Vac hopper fills with grass clippings. Use progressively greater care on slopes as the hopper fills.
- Always install and remove the Ultra Vac, including counterweights, as instructed. Failure to do so will cause a reduction in stability or traction. Do not operate the mower with only a portion of the Ultra Vac installed.

1.5 SAFETY SIGNS

- 1.5.1 Keep all safety signs legible. Remove all grease, dirt and debris from safety signs and instructional labels.
- 1.5.2 Safety signs must be replaced if they are missing or illegible.
- 1.5.3 When new components are installed, be sure that current safety signs are affixed to the replaced components.
- 1.5.4 New safety signs may be obtained from your authorized Exmark equipment dealer or distributor or from Exmark Mfg. Co. Inc.
- 1.5.5 Safety signs may be affixed by peeling off the backing to expose the adhesive surface. Apply only to a clean, dry surface. Smooth to remove any air bubbles.
- 1.5.6 Familiarize yourself with the following safety signs and instruction labels. They are critical to the safe operation of your Exmark Ultra Vac.

WARNING



- UNDER NORMAL USE, THIS BAG WILL DETERIORATE AND WEAR. OBJECTS MAY EXIT A WORN BAG AT HIGH SPEEDS CAUSING INJURY OR DEATH.
- CHECK BAG FREQUENTLY FOR TEARS AND HOLES.
- REPLACE BAG WITH AN ORIGINAL EQUIPMENT BAG THAT BEARS THIS WARNING.

1-653554

PART NO. 1-653554
LOCATION: Rear of Bags

WARNING

Ultra Vac and Ultra Vac counterbalance weight(s) combined incorrectly will cause Reduced Traction or Stability.

- To avoid Loss of Traction and Steering, Install Ultra Vac counterbalance weight(s) ONLY when Ultra Vac is installed.
- For correct Traction and Stability install weight(s) ONLY as indicated:

Installed Equipment	Weight Qty	Installed Equipment	Weight Qty
No Roll Bar and 2 bag Ultra Vac	0	Roll Bar and 2 bag Ultra Vac	1
No Roll Bar and QDS Ultra Vac	1	Roll Bar and QDS Ultra Vac	2

103-6604

For Units with a 2 Post ROPS only
PART NO. 103-6604
LOCATION: Top of Blower

WARNING

- Ultra Vac counterbalance weight installed without Ultra Vac may cause Loss of Traction and Steering.
- Ultra Vac installed without Ultra Vac counterbalance weight(s) will cause Reduction of Stability.
- Loss of Traction and Steering or Reduction of Stability may cause injury or death.
- Install weight(s) ONLY when Ultra Vac is installed.

103-6605

For Units with a 2 Post ROPS only
PART NO. 103-6605
LOCATION: Top of Front Weight

DANGER

COVER IS MISSING. DO NOT OPERATE THIS UNIT WHEN COVER IS NOT IN PLACE.

PART NO. 98-5954
LOCATION: Under Blower Cover

WARNING HOT SHEAVE
1-653558 ALLOW TO COOL →

PART NO. 1-653558
LOCATION: Top of Idler Arm

WARNING



- High Speed Discharge can cause Injury or Death.
- Do NOT run blower without discharge tube, hood and bags installed and latched.

CAUTION

- Read operator's manual.
- Hearing protection recommended.



103-3508

DANGER



103-3508

DANGER

- Rotating Blades can cause Injury or Death.
- Do NOT reach into blower unless rotation indicator has stopped. Disengage PTO, stop engine, remove key, WAIT FOR MOVING PARTS TO STOP.
- Do NOT operate mower without deflector chute or entire bag system in place.

PART NO. 103-3508
LOCATION: Top of Blower

2. SPECIFICATIONS

2.1 DIMENSIONS

2.2.1 Overall unit length w/ Ultra Vac	44" Deck	91.76"	(233.1 cm)
	46" Deck	94.69"	(240.5 cm)
	48" Deck	91.76"	(233.1 cm)
	50" Deck	95.12"	(241.6 cm)
	52" Deck	93.00"	(236.2 cm)
	56" Deck	97.86"	(248.6 cm)

2.2.2 Overall unit width w/ Ultra Vac	44" Deck	58.47"	(148.5 cm)
	46" Deck	60.67"	(154.1 cm)
	48" Deck	61.73"	(159.8 cm)
	50" Deck	64.66"	(164.2 cm)
	52" Deck	66.47"	(168.8 cm)
	56" Deck	70.85"	(180.0 cm)



2.2 BAGGING SYSTEM

- 2.2.1 Weight: Lazer Z HP -156 lbs. (71kg), including the front weight.
- 2.2.2 Collections bins: Commercial grade, cloth mesh bags with reinforced bottoms.
Capacity: Lazer Z HPs - 8 bushels (2 bags and hood)
- 2.2.3 Dump Mechanism: Manual lift off
- 2.2.4 Blower tube: fixed, abrasion resistant molded polyethylene
- 2.2.5 Impeller: 5-bladed, 0.25" thick abrasion resistant steel, with vertical axis.
- 2.2.6 Impeller bearings: 1" (2.54 cm) sealed "non-greaseable bearings"

3. OPERATION

3.1 PRE-START

- 3.1.1 Read the operator's manual for your mower and familiarize yourself with all controls before operating the machine. Make sure that you understand the controls, their locations, their functions, and their safety requirements.
- 3.1.2 Ensure the blower, belt cover, bags, tube and hood are in good condition, properly attached, and latched.
- 3.1.3 For units above 600,000 with Triton decks: Make sure that adjustable dog leg baffle is closed to match the intake into the Ultra Vac Blower.

 WARNING 
POTENTIAL HAZARD <ul style="list-style-type: none"> ◆ If the blower intake opening is not correct it will allow objects to be thrown in operator's or bystander's direction. Also, contact with blade could occur.
WHAT CAN HAPPEN <ul style="list-style-type: none"> ◆ Thrown objects or blade contact can cause serious injury or kill you or bystanders.
HOW TO AVOID THE HAZARD <ul style="list-style-type: none"> ◆ Adjust dog leg baffle to match intake opening.

3.2 MOWING

- 3.2.1 The Ultra Vac blower operates when deck drive is engaged. Be sure that **all** persons are **clear** of the mower deck **before engaging** the cutting blades. Set the throttle to “midway” position. Pull outward on the PTO switch to the “ROTATE” position. Accelerate to full throttle to begin mowing.
- 3.2.2 To disengage the deck drive and blower, set the throttle to “midway” position. Push in on the PTO switch to the “STOP” position to stop the cutting blades and blower. The cutting blades will require a slightly longer amount of time to come to a complete stop when the blower is installed on the deck.
- 3.2.3 To remove the bags, shut off deck drive, stop the engine and wait for all moving parts to stop. Open the hood and remove the bags by lifting up on the rear of the bag, then unhooking the front clip. Empty bags by inverting them.
- 3.2.4 Reinstall bags, close and latch the hood before continuing mowing.

3.3 BAGGER REMOVAL FOR SIDE DISCHARGE:

- 3.3.1 Shut off the deck drive, stop engine and wait for all moving parts to stop. Remove key.
- 3.3.2 Remove the discharge tube by releasing the latch at the blower. Slide the tube off the blower outlet and remove the upper end from the hood.
- 3.3.3 Remove the belt cover by loosening the knobs.

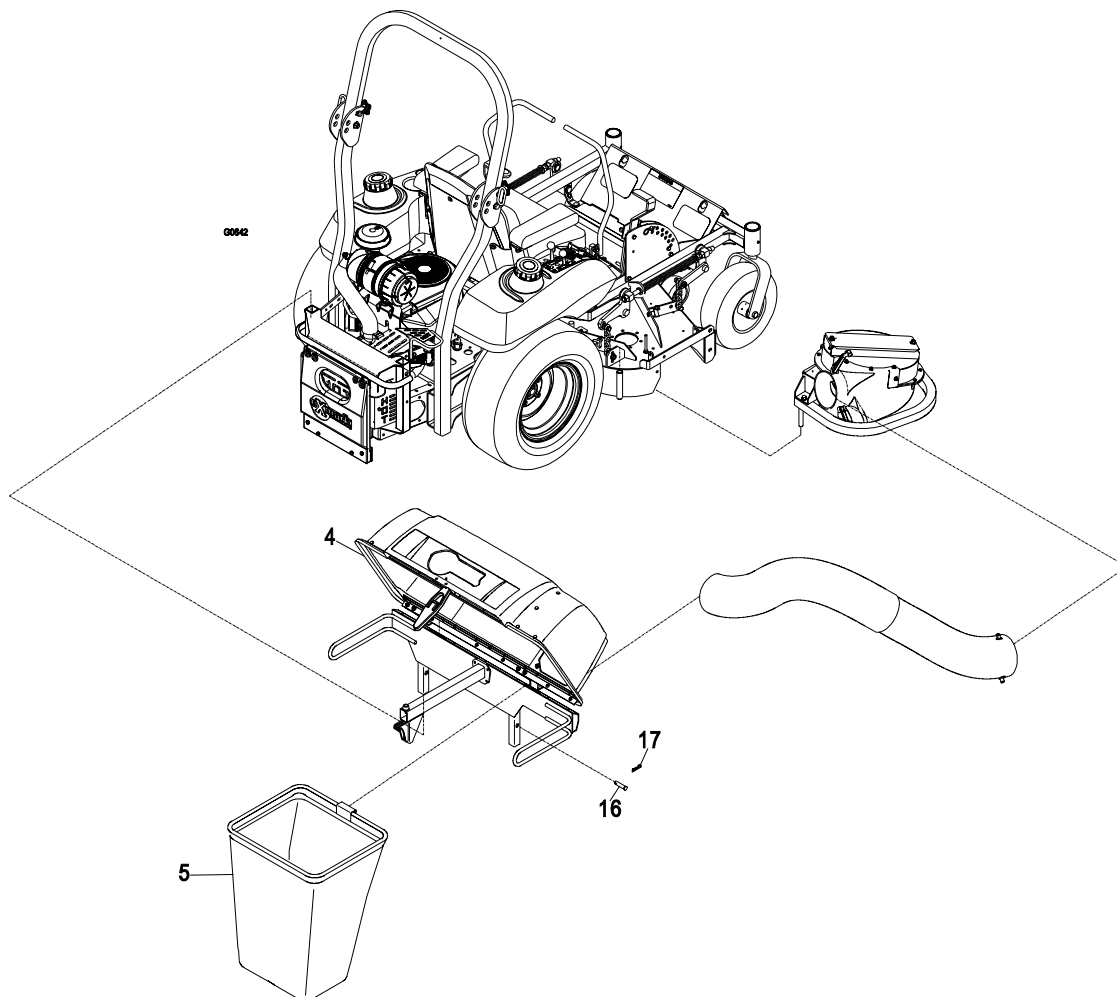

FIGURE 2

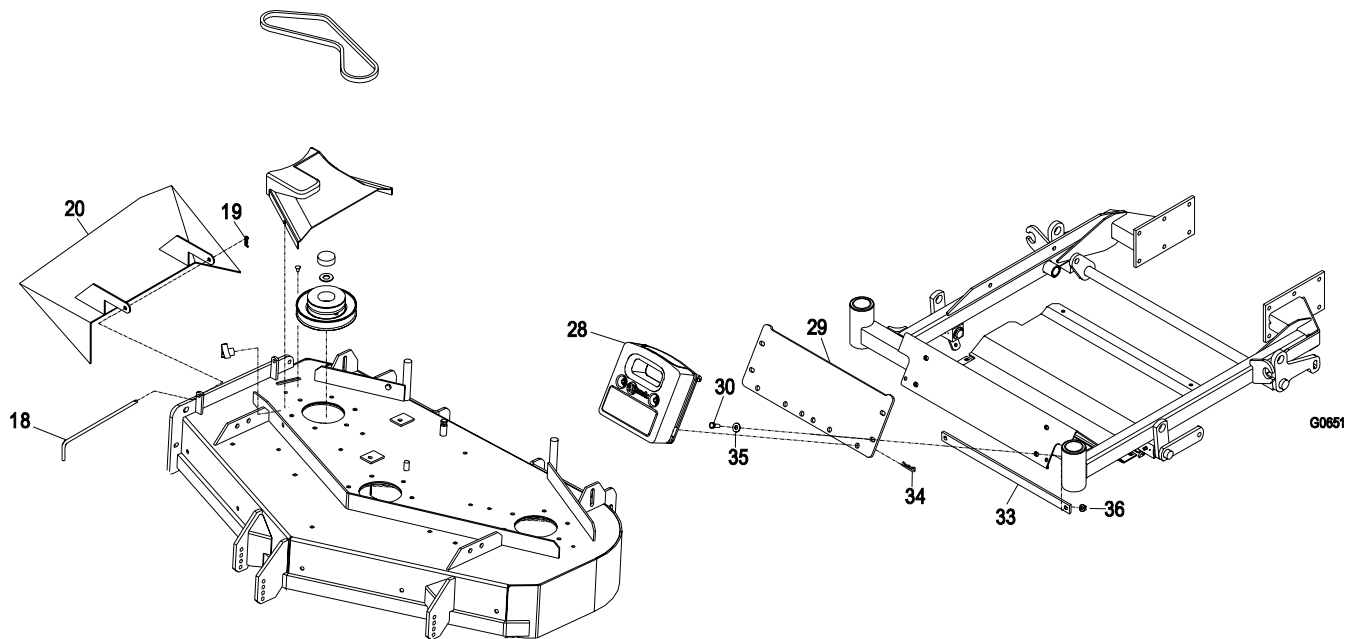

FIGURE 3

CAUTION	
POTENTIAL HAZARD	
◆ The deck sheave will become very hot	
WHAT CAN HAPPEN	
◆ Touching a hot deck sheave can cause severe burns.	
HOW TO AVOID THE HAZARD	
◆ Allow the deck sheave to cool completely before removing the belt.	

- 3.3.4 Pull the idler release handle and remove the belt from the upper groove of the deck sheave.
- 3.3.5 Unlatch the front end of the blower. Pivot the blower back and lift it off the deck.
- 3.3.6 Install the discharge chute using the chute pivot pin (Item 18) and hairpin (Item 19) (See Figure 4).

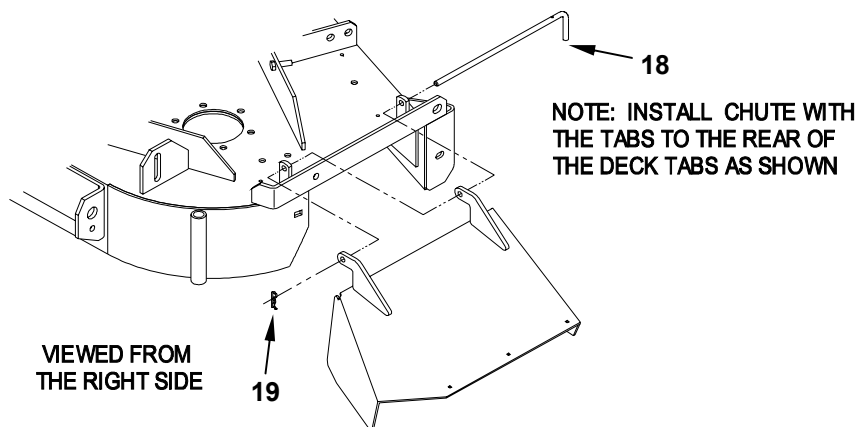

FIGURE 4

- 3.3.7 Re-install the plastic belt cover and tighten the knobs.
- 3.3.8 Remove the hair pins and clevis pins holding the hood assembly to the mount weldment.
- 3.3.9 Lift the bag and hood assembly off the mount.
- 3.3.10 *For units with a 2 post ROPS installed:* Remove the hairpins and lift the front weight off of the mount plates.

Note: The portions of the Ultra Vac bagger that are not bolted to the mower are designed to be installed or removed in their entirety. Do not operate the mower with only a portion of the Ultra Vac installed.

- 3.3.11 The machine can now be used for side discharge mowing.

3.4 BAGGER INSTALLATION FOR BAGGING



- 3.4.1 Stop engine, remove key, and wait for all moving parts to stop.
- 3.4.2 Remove hairpin and chute pivot pin. Remove discharge chute. Pivot pin and hair pin may be stored in the pivot holes of the discharge chute during bagging operation.
- 3.4.3 Slide tube ends of Hood Assembly (Item 4) into the tubes of the mount weldment. Install (2) clevis pins (Item 16) through holes in tubes. Retain with (2) Hair Pins (Item 17).
- 3.4.4 Hang the (2) Bag Assemblies (Item 5) from the slots in the Bagger Upright. Close and latch hood.
- 3.4.5 Remove the belt cover on the right side of the deck. Install the blower by inserting the mounting pin into the tube welded to the rear corner of the deck. Pivot the blower until the front pin engages the slot in the deck. Adjust the position of the front pin if necessary to engage the slot. Use the latches to lock the blower in this position.
- 3.4.6 Pull the idler release handle and install the belt in the upper groove of the deck sheave.
- 3.4.7 Install the belt cover using the two knobs. Install the discharge tube assembly by slipping the upper end into the hood, then sliding the lower end over the blower discharge opening. Use the latches to retain the lower end to the blower.



On Units > 600,000 with Triton decks:

- 3.4.8 Adjust position of dog leg baffle to match the intake of the Ultra Vac blower baffle adjusted too wide may allow objects to be thrown from under deck. Baffle adjusted too narrow may cause plugging issues.

3.5 TRANSPORTING

- 3.5.1 Transporting a Unit: Use a heavy-duty trailer or truck to transport the machine. Lock brake and block wheels. Securely fasten the machine to the trailer or truck with straps, chains, cable, or ropes. Be sure that the trailer or truck has all necessary lighting and marking as required by law. Secure a trailer with a safety chain.

 CAUTION 	
POTENTIAL HAZARD	
<ul style="list-style-type: none">◆ This unit does not have proper turn signals, lights, reflective markings, or a slow moving vehicle emblem. These items are required to drive on a public street or roadway.	
WHAT CAN HAPPEN	
<ul style="list-style-type: none">◆ Driving on a street or roadway without such equipment is dangerous and can lead to accidents causing personal injury.◆ Driving on a street or roadway without such equipment may also be a violation of State laws and the operator may be subject to traffic tickets and/or fines.	
HOW TO AVOID THE HAZARD	
<ul style="list-style-type: none">◆ Do not drive a unit on a public street or roadway.	

 WARNING 	
POTENTIAL HAZARD	
<ul style="list-style-type: none">◆ Loading a unit on a trailer or truck increases the possibility of backward tip-over.	
WHAT CAN HAPPEN	
<ul style="list-style-type: none">◆ Backward tip-over of the unit could cause serious injury or death.	
HOW TO AVOID THE HAZARD	
<ul style="list-style-type: none">◆ Use extreme caution when operating a unit on a ramp.◆ Use only a single, full width ramp; DO NOT use individual ramps for each side of the unit.◆ If individual ramps must be used, use enough ramps to create an unbroken ramp surface wider than the unit.◆ DO NOT exceed a 15° angle between ramp and ground or between ramp and trailer or truck.◆ Avoid sudden acceleration while driving unit up a ramp to avoid tipping backward.◆ Avoid sudden deceleration while backing unit down a ramp to avoid tipping backward.	

Loading a Unit: **Empty grass bags before attempting to load unit on trailer or truck.** Use extreme caution when loading units on trailers or trucks. One full width ramp that is wide enough to extend beyond the rear tires is required instead of individual ramps for each side of the unit. The lower rear section of the tractor



frame extends back between the rear wheels and serves as a stop for tipping backward. Having a full width ramp provides a surface for the frame members to contact if the unit starts to tip backward. If it is not possible to use one full width ramp, use enough individual ramps to simulate a full width continuous ramp.



Ramp should be long enough so that the angles between the ramp and the ground; and the ramp and the trailer, or truck, do not exceed 15°. A steeper angle may cause mower deck components to get caught as the unit moves from ramp to trailer or truck. Steeper angles may also cause the unit to tip backward. If loading on or near a slope, position the trailer or truck so it is on the down side of the slope and the ramp extends up the slope. This will minimize the ramp angle. The trailer or truck should be as level as possible.

DO NOT attempt to turn the unit while on the ramp, you may lose control and drive off the side.

Avoid sudden acceleration when driving up a ramp and sudden deceleration when backing down a ramp. Both maneuvers can cause the unit to tip backward.

4. MAINTENANCE

 WARNING 	
POTENTIAL HAZARD	◆ While maintenance or adjustments are being made, someone could start the engine.
WHAT CAN HAPPEN	◆ Accidental starting of the engine could seriously injure you or other bystanders.
HOW TO AVOID THE HAZARD	◆ Remove the key from the ignition switch and pull the wire(s) off the spark plug(s) before you do any maintenance. Also push the wire(s) aside so it does not accidentally contact the spark plug(s).

 WARNING 	
POTENTIAL HAZARD	◆ The engine can become very hot.
WHAT CAN HAPPEN	◆ Touching a hot engine can cause severe burns.
HOW TO AVOID THE HAZARD	◆ Allow the engine to cool completely before service or making repairs around the engine area.

3.4 PERIODIC MAINTENANCE

FITTING LOCATIONS	INITIAL PUMPS	NO. of PLACES	SERVICE INTERVAL
1. Blower Housing/Impeller	1	1	Daily
2. Idler Bushings	1-2		25 hours
3. Bags			Daily
4. Belts			50 hours
5. Muffler/Rear Frame			Daily
6. Rear Screen			Daily

IMPORTANT: Before conducting any maintenance, shut off deck drive, stop engine and wait for all moving parts to stop. Remove spark plug wire(s) or remove key.

3.4.1 Blower Housing/Impeller:

Inspect for wear or damage daily. Replace or repair worn parts as needed.



Note: When mowing in areas with sandy soil, use low lift blades on the cutting deck and higher cutting heights to minimize wear on the blower components.

3.4.2 Idler Bushings:

Lubricate with 1-2 pumps of SAE No. 2 multi-purpose grease.

3.4.3 Bags:

Inspect the bags for wear, tears, or damage.

 WARNING 
POTENTIAL HAZARD ◆ Under normal use the bag will deteriorate and wear. Objects could exit a worn bag at high speeds.
WHAT CAN HAPPEN ◆ Thrown objects can cause serious injury or kill you or bystanders.
HOW TO AVOID THE HAZARD ◆ Check bag frequently for tears and holes. Replace worn bag.

3.4.4 Belts.

a) Inspect the belt position on the idler arm.

The idler arm may become bent during use or transport. A bent idler arm could cause the belt to jump off of the idler and be damaged.

- 1) Make sure the belt cover is installed and run the blower for one to two minutes.
- 2) **Shut off the deck drive, stop engine and wait for all moving parts to stop. Remove key.** Remove the belt cover and check to make sure that the belt is riding near the center of the flat idler on the idler arm.
- 3) If the belt is not riding near the center of the idler, remove the blower, and bend the idler arm slightly.
- 4) Reinstall the blower and belt cover and repeat steps 1-3 until the belt is positioned near the center of the idler.

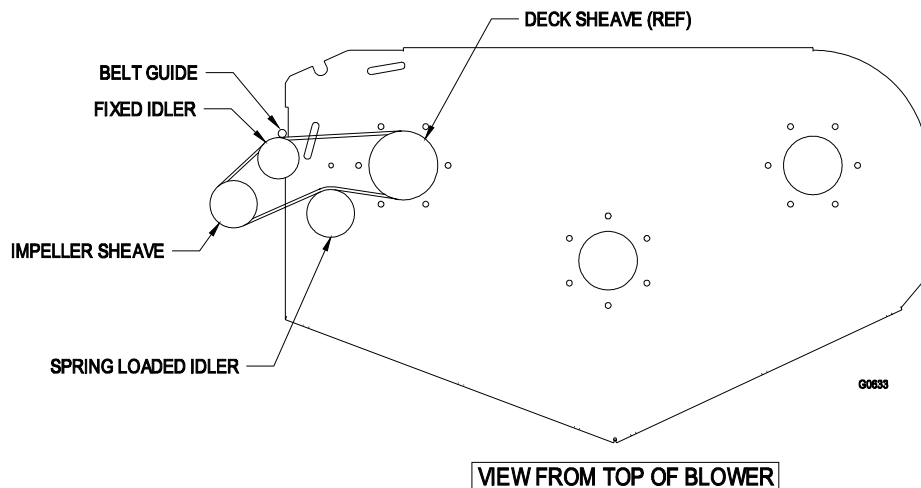

- b) Inspect the belt for damage or wear. Replace belt with one of the following.
 - 44" deck – PN 1-653332
 - 46" deck – PN 1-653438
 - 48" deck – PN 1-653333
 - 50" deck – PN 109-1240
 - 52" deck – PN 1-653438
 - 56" deck – PN 109-1241
- c) Remove the belt guide on the blower (See Figure 5)
- d) Install the belt (from the Drive Kit) onto the Blower Assembly as shown.



**FIGURE 5
BELT ROUTING**

- e) Reinstall the belt guide removed previously.
- f) Remove Discharge chute by pulling the hairpin and chute pivot pin (from the Drive Kit installed in section 3.3).

3.4.5 Clean muffler and rear frame area:

 WARNING 	
POTENTIAL HAZARD	
◆ Operating engine parts, especially the muffler, become extremely hot.	
WHAT CAN HAPPEN	
◆ Severe burns can occur on contact.	
◆ Debris, such as leaves, grass, brush, etc. can catch fire.	
HOW TO AVOID THE HAZARD	
◆ Allow engine parts, especially the muffler, to cool before touching.	
◆ Remove accumulated debris from muffler and engine area.	
◆ Install and maintain in working order a spark arrester before using equipment on forest-covered, grass-covered, brush-covered unimproved land.	

3.4.6 Clean rear screen in the hood:

3.4.7 Open hood and remove clippings that are stuck to the screen.

5. TIPS AND TROUBLESHOOTING

Your Exmark Ultra Vac has been designed to be the most productive bagging system on the market. The following tips have been collected to help you get the most out of your Ultra Vac right from the start.

- 5.1 When mowing in areas with sandy soil, use low lift blades on the cutting deck and higher cutting heights to minimize wear on the blower components.
- 5.2 When mowing in wet conditions, such as just after a rain or in heavy dew, use low lift blades on the cutting deck to minimize plugging of the blower.
- 5.3 When the bags get full, the sound of the blower will change and there will be slight blowout from the front right corner of the deck. Emptying the bags at this point will minimize the potential for the tube to plug.
- 5.4 If there is excessive blowout from the deck, check to make sure that the rear screen in the hood is clear of grass build up. It is recommended that the screen and mesh portions of the bags be cleaned regularly to maintain proper air flow. This is especially important in wet conditions.
- 5.5 During dry conditions check engine air cleaners and clean cooling fins more frequently. The Ultra Vac has been designed to minimize the impact of dust and debris on the mower, but bagging can be a dirty environment.
- 5.6 During dry conditions, switching to a lower lift blade may reduce blowout without hurting quality of cut.
- 5.7 Maintaining a ground speed that does not pull down the engine RPM will allow for the highest productivity and best quality of cut. Boggling the engine RPM down by going too fast will cause plugging and quality of cut issues.
- 5.8 When storing the Ultra Vac, it is recommended that any build up in the blower be cleaned out. Dry grass build up may cause problems with the impeller when the unit is put back into operation.
- 5.9 If the blower drive belt snaps or breaks frequently, check the alignment of the idler arm per section 4.1.4. An arm that is bent out of position can cause the belt to jump off of the idler and be cut by the sheaves.
- 5.10 If the idler pulley contacts the deck sheave, check the alignment of the idler arm per section 4.1.4. Also check the mounting tube on the deck and the mounting pin on the blower for bending or excessive wear. This condition is more likely to occur with smaller deck sizes.
- 5.11 The condition of the belt drive is critical to proper operation. A sticking idler arm or worn belt may cause plugging or blowout. Replace the belt when the idler arm is riding on or near the stop.
- 5.12 **For units below SN 600,000:** Anti-blowout kits are available for leaf collection. They help to prevent “chasing” the leaves. To reduce “plowing” leaves, raise the deck slightly.
- 5.13 **On Triton:** Raise front adjustable baffle to reduce plowing. Lowering front adjustable baffle may prevent “chasing”. Match discharge opening to Ultra Vac intake for best performance.

6.

**2-Year Limited Warranty
Exmark Turf Equipment**

(For units purchased on or after October 1, 2004)

Conditions and Products Covered

Exmark Mfg. Co. Inc. and its affiliate, Exmark Warranty Company, pursuant to an agreement between them, jointly warrant on the terms and conditions herein, that we will repair, replace or adjust any part manufactured by Exmark and found by us (in the exercise of our reasonable discretion) to be defective in factory materials or workmanship for a period of two years.

This warranty applies to Exmark turf equipment purchased on or after October 1, 2004 sold in the US or Canada. This warranty may only be assigned or transferred to a second (or third) owner by an authorized Exmark dealer. The warranty period commences upon the date of the original retail purchase.

<u>Products</u>	<u>Warranty Period</u>
• All Products (except as noted below)	2 years
• All Attachments and Accessories	1 year
• Metro 21 and Metro 26 Series	1 year
• Belts and Tires	90 days
• Battery	1 Year Prorated
• Engine*	Warranty is covered by engine manufacturer

*Please refer to the engine manufacturer's warranty statement that is included in the literature packet. We are not authorized to handle warranty adjustments on engines.

This warranty only includes the cost of parts and labor.

Items and Conditions Not Covered

This warranty does not cover the following:

- Pickup and delivery charges to and from any authorized Exmark Service Dealer.
- Any damage or deterioration due to normal use, wear and tear, or exposure.
- Cost of regular maintenance service or parts, such as filters, fuel, lubricants, tune-up parts, and adjustments.
- Any product or part which has been altered or misused or required replacement or repair due to normal wear, accidents, or lack of proper maintenance.
- Any repairs necessary due to use of parts, accessories or supplies, including gasoline, oil or lubricants, incompatible with the turf equipment or other than as recommended in the operator's manual or other operational instructions provided by Exmark.

All warranty work must be performed by an authorized Exmark Service Dealer using Exmark approved replacement parts.

Instructions for Obtaining Warranty Service

1. Contact any Exmark Service Dealer to arrange service at their dealership. To locate a dealer convenient to you, access our website at www.exmark.com. U.S. Customers may also call 402-223-6375.
2. Bring the product and your proof of purchase (sales receipt) to the Exmark Service Dealer.

If for any reason you are dissatisfied with the Service Dealer's analysis or with the assistance provided, contact us at:

Exmark Customer Service Department
The Exmark Warranty Company
2101 Ashland Avenue
Beatrice, NE 68310
402-223-6375 or service@exmark.com

Owner's Responsibilities

The Exmark turf equipment, including any defective part, must be returned to an authorized Exmark service dealer within the warranty period. This warranty extends only to turf equipment operated under normal conditions. You must properly service and maintain your Exmark product as described in the operator's manual. Such routine maintenance, whether performed by a dealer or by you, is at your expense.

As a condition to this warranty, customer shall have read the operator's manual and shall have completed and submitted to Exmark Warranty Company, within the prescribed time, the Exmark warranty registration.

General Conditions

The sole liability of Exmark and Exmark Warranty Company with respect to this warranty shall be repair and replacement as set forth herein. **Neither Exmark nor Exmark Warranty Company shall have any liability for any other cost, loss or damage, including but not limited to, any incidental or consequential loss or damage.**

In particular, we shall have no liability or responsibility for:

- Expenses related to gasoline, oil or lubricants.
- Travel time, overtime, after hours time or other extraordinary repair charges or charge relating to repairs or replacements outside of normal business hours at the place of business of the authorized Exmark service dealer.
- Rental of like or similar replacement equipment during the period of any warranty, repair or replacement work.
- Any telephone or telegram charges or travel charges.
- Loss or damage to person or property other than that covered by the terms of this warranty.
- Any claims for lost revenue, lost profit or additional cost as a result of a claim of breach of warranty.
- Attorney's fees.

No Claim of breach of warranty shall be cause for cancellation or rescission of the contract of sale of any Exmark mower.

There are no understandings, agreements, representations, or warranties, express or implied, including but not limited to any regarding the merchantability (that product is fit for ordinary use) or fitness for use (that product is fit for a particular purpose), not specified herein, respecting the equipment which is the subject of this warranty.

Some states do not allow exclusions of incidental or consequential damages, or limitations on how long an implied warranty lasts, so the above exclusions and limitations may not apply to you.

This warranty gives you specific legal rights, and you may also have other rights which vary from state to state.

NOTES

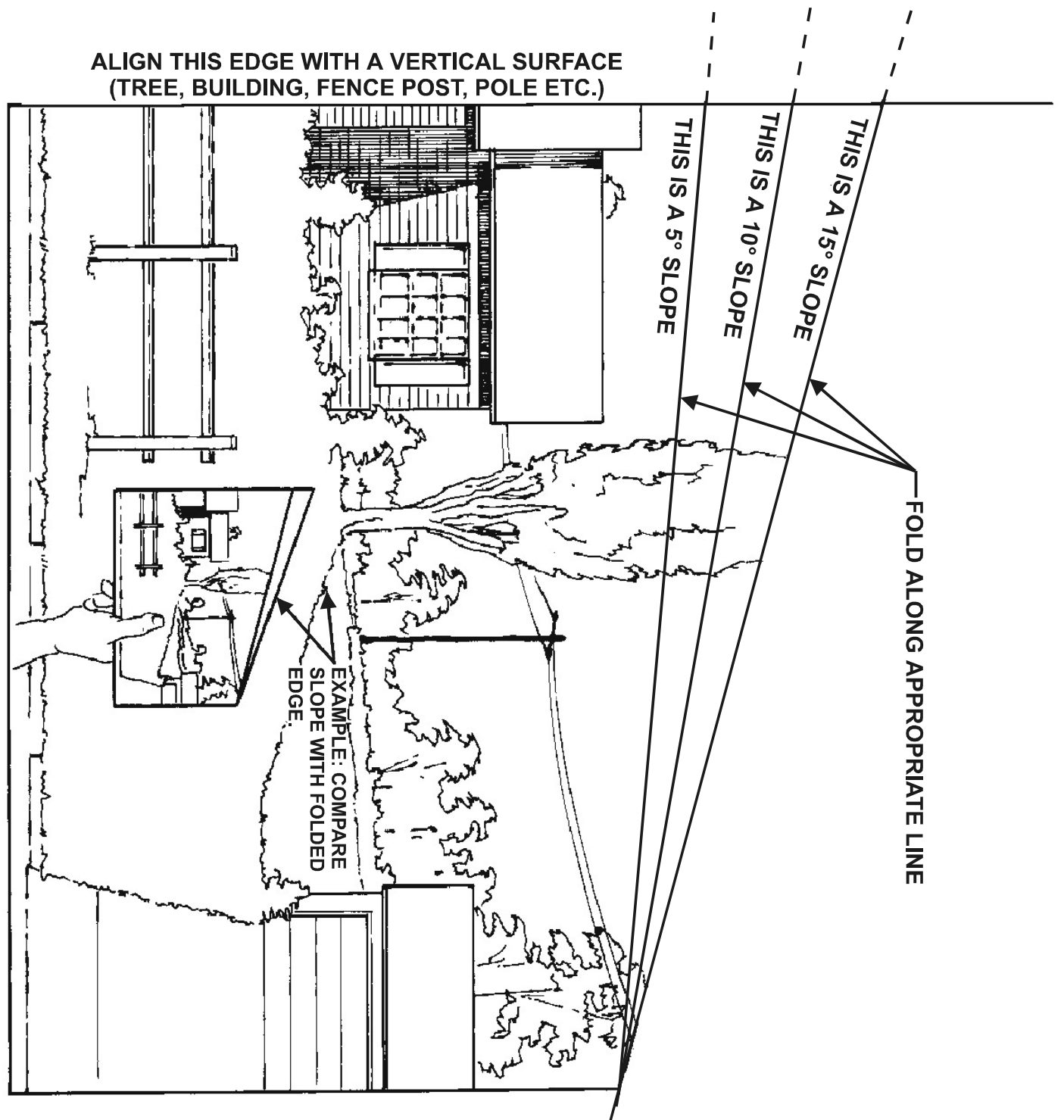

SEE EXMARK'S COMPLETE LINE OF ACCESSORIES

RIDING ACCESSORIES

CUSTOM RIDE SEAT SUSPENSION SYSTEM
DECK LIFT ASSIST KIT
HITCH KIT
LIGHT KIT
MICRO-MULCH SYSTEM
ROLL OVER PROTECTION SYSTEM (ROPS)
SNOW BLADE
SUN SHADE
TRASH CONTAINER
TURF STRIPER
ULTRA VAC COLLECTION SYSTEM
ULTRA VAC QUICK DISPOSAL SYSTEM

WALK BEHIND ACCESSORIES

GRASS CATCHER
MICRO-MULCH SYSTEM
STEERABLE SULKY
SULKY HITCH KIT
TURF STRIPER

Check us out on the Web:

www.exmark.com



WARNING



The engine exhaust from this product contains chemicals known to the State of California to cause cancer, birth defects, or other reproductive harm.

©2004-2005 EXMARK MFG. CO. INC.
INDUSTRIAL PARK BOX 808
BEATRICE, NE 68310

PART NO. 109-1032 Rev. A
(402) 223-6300
FAX (402) 223-5489

ALL RIGHTS RESERVED

PRINTED IN U.S.A.

