

For Serial Nos.
600,000 & Higher



PARTS MANUAL

TURF TRACER[®] HP

CONGRATULATIONS on the purchase of your new Exmark mower. This product has been carefully designed and manufactured to give you a maximum amount of dependability and years of trouble-free operation. If additional information is needed, or should you require trained mechanic service, contact your authorized Exmark equipment dealer or distributor. If you need to order replacement parts from your dealer, always give the model number and serial number of your mower as well as the part number, description and quantity of the part needed.

The Serial No. plate is located next to the fuel tank on the top left hand side of the fuel tank support. For ease of ordering and reference, we suggest that you record the information requested in the following identification table.

Place Model No. and Serial No. Label Here
(Included in Literature Pack)
or Fill in Below

Model No. _____

Serial No. _____

Engine Model No. and Spec. No. (Code) _____

Engine Serial No. (E/No) _____

Date Purchased _____

Part No. 109-0490 Rev. A

EXMARK PARTS PLUS® PROGRAM

EFFECTIVE DATE: September 1, 1995

Program

If your Exmark dealer does not have the Exmark part in stock, Exmark will get the parts to the dealer the next business day or the part will be FREE* Guaranteed!!

How the Program Works

1. If dealer does not have part in stock for a "down" unit at the time of request by customer, the dealer contacts his distributor by 1:00 p.m., local time, and requests Exmark Parts Plus® shipment of six (6) line items or less.
2. Distributor ships part(s) to dealer or customer, as requested by dealer, same day, overnight UPS. Distributor bills dealer for part and freight charges where applicable.
3. If distributor does not have the part(s) in stock to satisfy Exmark Parts Plus® order, he contacts Exmark by 3:00 p.m., central time, with an Exmark Parts Plus® order of six (6) line items or less.
4. If order is received by 3:00 p.m. central time, Exmark ships part(s) direct to dealer or customer, as requested by distributor, same day, overnight UPS. Exmark bills the distributor for parts and shipping charges, where applicable.
5. The customer pays for the part and freight if it is shipped under the Exmark Parts Plus® and if it arrive in accordance to the program.
6. Who pays for the part and freight if it fails to arrive overnight in accordance to the program?
 - A. Under any circumstance the customer does not pay.
 - B. If the part does not arrive overnight due to:
 1. The dealer not submitting the Exmark Parts Plus® order to his Exmark distributor by 1:00 p.m., the dealer pays for the part and freight.
 2. The Distributor being unable to ship the part the same day or not submitting the Exmark Parts Plus® order to Exmark by 3:00 p.m., central time, the Distributor pays for the part and freight.
 3. Exmark being unable to ship the part and the Exmark parts order is received by 3:00 p.m., central time, Exmark pays for the part and freight.
 4. If the part does not arrive overnight due to the shipper (UPS), the shipper pays for the freight and Exmark pays for the part.

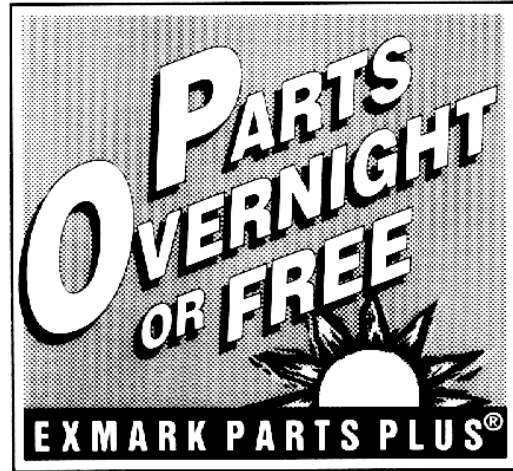

The following restrictions apply -- The Exmark Parts Plus® Program is available only through participating Exmark Dealers and applies only to orders submitted on this program Monday through Thursday. Parts Plus service is available only in the contiguous United States. UPS has initiated a Saturday delivery program to many areas of the continental United States and can be requested for an overnight shipment on Friday to be delivered Saturday. The next day air charge, plus the Saturday delivery fee will be the responsibility of the purchaser. Exmark Mfg. will assume no responsibility for Saturday delivery shipments. To qualify, all Exmark Parts Plus® orders must be received by Exmark by 3:00 p.m., central time. Orders must be six (6) line items or less. Exclusions from the Exmark Parts Plus® Program are: Any wholegood or accessory in its entirety, engines and engine replacement parts, 5-speed Peerless transmissions and 5-speed transaxles, hydraulic or hydrostatic wheel motors, cutter decks and engine decks or any item exceeding United Parcel Service size and weight restrictions.

Due to UPS restrictions, aerosol spray paint is considered a hazardous material and cannot be shipped via UPS next day or Second Day Air.

Exmark Manufacturing stocks a limited supply of parts for transaxles, pumps and wheel motors. These parts can be ordered for Next Day Air shipment but will not be guaranteed per the Parts Plus Program.



**READ OPERATOR'S MANUAL BEFORE
OPERATING OR SERVICING EXMARK EQUIPMENT.**

TABLE OF CONTENTS

<u>Description</u>	<u>Page</u>
36" Mower Deck	3-4
48" Mower Deck	5-6
52" Mower Deck	7-8
Decals	17-18
Electrical Group.....	15
Engine Deck Group.....	9-12
Hydraulics Group.....	19
Upper Handles & Controls, ECS.....	13-14
Wiring Diagrams.....	16

36" MOWER DECK

Item	Part No.	Description	Qty.
1	1-414386	Shield, Belt (1-413098-01) W/Decals	1
2	1-323385	Knob	4
3	1-323417	Washer	4
4	1-414309	Wld, Support (1-412108-01) W/Bushings & Decals	1
5	1-413425	Spacer, Front Deck Support	2
6	1-513336	Bushing, Deck Support	2
7	302-61	Zerk, 45° 1/4-28	2
8	1-323539	Spacer	2
9	1-413525	Link, Deck Support	2
10	323-7	Screw, HH 3/8-16 x 1 1/4	20
11	3219-3	Nut, Hex 3/8-24	2
12	32120-33	Ring, Retaining	2
13	1-806009	Hairpin, Cotter #206	4
14	302-52	Zerk, 1/8-27 Str	2
15	323-6	Screw, HH 3/8-16 x 1	2
16	3253-5	Washer, Lock 3/8 Heavy	2
17	1-373034	Washer	2
18	1-303514	Bearing, Flange	4
19	3217-9	Nut, Hex 1/2-13	2
20	3253-7	Washer, Lock 1/2	2
21	1-522143-01	Wld, Caster	2
22	325-20	Screw, HH 1/2-13 x 6	2
23	3290-357	Nut, Whizlock 3/8-16	13
24	98-5975	Washer, Spring Disk 3/8	11
25	3213-5	Screw, HH 1/2-20 x 2	2
26	1-513435	Washer, Spring Disk 1/2	2
27	103-2431-01	Wld, Discharge Chute	1
28	1-413094	Belt, Deck Drive	1
29	103-3330	Spring, Extension	1
30	3296-39	Nut, Nyloc 3/8-16	13
31	103-3506	Seal, Single Lip	1
32	32120-10	Ring, Retaining	2
33	302-40	Zerk, 90° 1/4-28	1
34	3234-11	Screw, HH FLG 3/8-16 x 1	1
35	3256-24	Washer, 3/8 SAE	2
36	1-413099	Pulley, Idler	1
37★	103-8584	Kit, Idler Arm (103-7327-03) W/Brgs	1
38	103-3504	Bearing, Spherical	2
39	1-613098	Pulley, Idler	1
40	1-413113	Bushing, Idler	1
41	3296-29	Nut, Nyloc 5/16-18	2

Item	Part No.	Description	Qty.
42	32128-20	Nut, Whizlock 5/16-18	3
43	322-5	Screw, HH 5/16-18 x 1	2
44	1-603001	Rod, Deck Support	2
45	1-806332	Rollpin, 1/4 x 1 1/2	2
46	322-2	Screw, HH 5/16-18 x 5/8	3
47	1-414383	Wld, Deck (1-412104-01) W/Decals, Discharge Baffle & Support Rods	1
48	1-522480-01	Baffle, Discharge	1
49	1-613204	Balljoint	2
50	323-13	Screw, HH 3/8-16 x 2 3/4	1
51	98-5961	Screw, HH 3/8-16 x 4 Gr8	1
52◆	1-603299	Roller, Antiscalp	1
53	99-2842	Spacer	1
54	1-513809	Bearing, Roller Bearing	2
55	1-603050	Bushing Spacer	2
56	323-9	Screw, HH 3/8-16x1 3/4	2
57★	1-414521	Link, Assembly	2
58	1-611216	Kit, Link Assembly	2
59	103-0320	Asm, Deck Complete	1
60*	3217-46	Nut, HH 3/4-16 Heavy	2
61	103-2802	Washer, Spring Disc 3/4	2
62+	1-413424	Sheave W/ Hub	2
63+	103-1330	Guard, Bearing Top	2
64	103-8280	Asm, Cutter Housing W/Bearings	2
65	103-9081	Asm, Cutter Housing Complete	2
66	103-2171	Kit, Tire & Wheel Asm W/Spacer	2
67	103-2535	Spacer, Guard Bottom	2
68+□	103-9071	Kit, Spindle	2
69	1-807268	Key, Machine 1/4 x 3/16 x 1	2
70	103-6402	Blade, 18.00 Notched	2
●	103-6392	Blade, 18.00 Mulching	2
	103-6387	Blade, 18.00 Low Lift	2
	103-6382	Blade, 18.00 Solid	2
	103-6397	Blade, 18.00 Extreme	2
71	1-513547	Spacer	2
72	1-513810	Bushing	4
73	106-7159	O-ring	2
74	103-5677	Spacer	1
75	103-3505	Seal, Double, Lip	1
76	103-2916	Guard, Top	1
77	103-3037	Bushing, Splined	2
78	63-8410	Washer	1

Exmark red touch up paint (spray paint - P/N 1-850337 - .6 oz liquid bottle - P/N 103-9140).

- ◇ Kit 103-4051 includes antiscalp roller, spacer, & mounting hardware.
- ★ Link assembly nominal length is 6.89" (or approximately 6 7/8") between center of ball joint and center of furthest hole. See diagram on next page. Initially adjust both links to this dimension, then adjust to where both links are equally supporting rear of mower deck by lengthening one link and shortening the other by an equal amount.
- Requires installation of Micro-Mulch accessory for proper mulching. Mulch kit P/N's MK363Q(36").
- + Apply Mobil HTS grease (P/N 103-5217 1.5 oz packet) (or a food-grade anti-sieze) between the spindles & bearings and spindles & sheaves and under top bearing guard. DO NOT use a copper or nickel based anti-sieze.
- ✘ Idler arm kit also includes items 24 & 51.
- * Use Pro-Lock, Nut Type (P/N 1-840022, .5ml tube) on nut Item 60.
- Kit includes items 25, 26, 60, 61, 69 & 77.

36" MOWER DECK

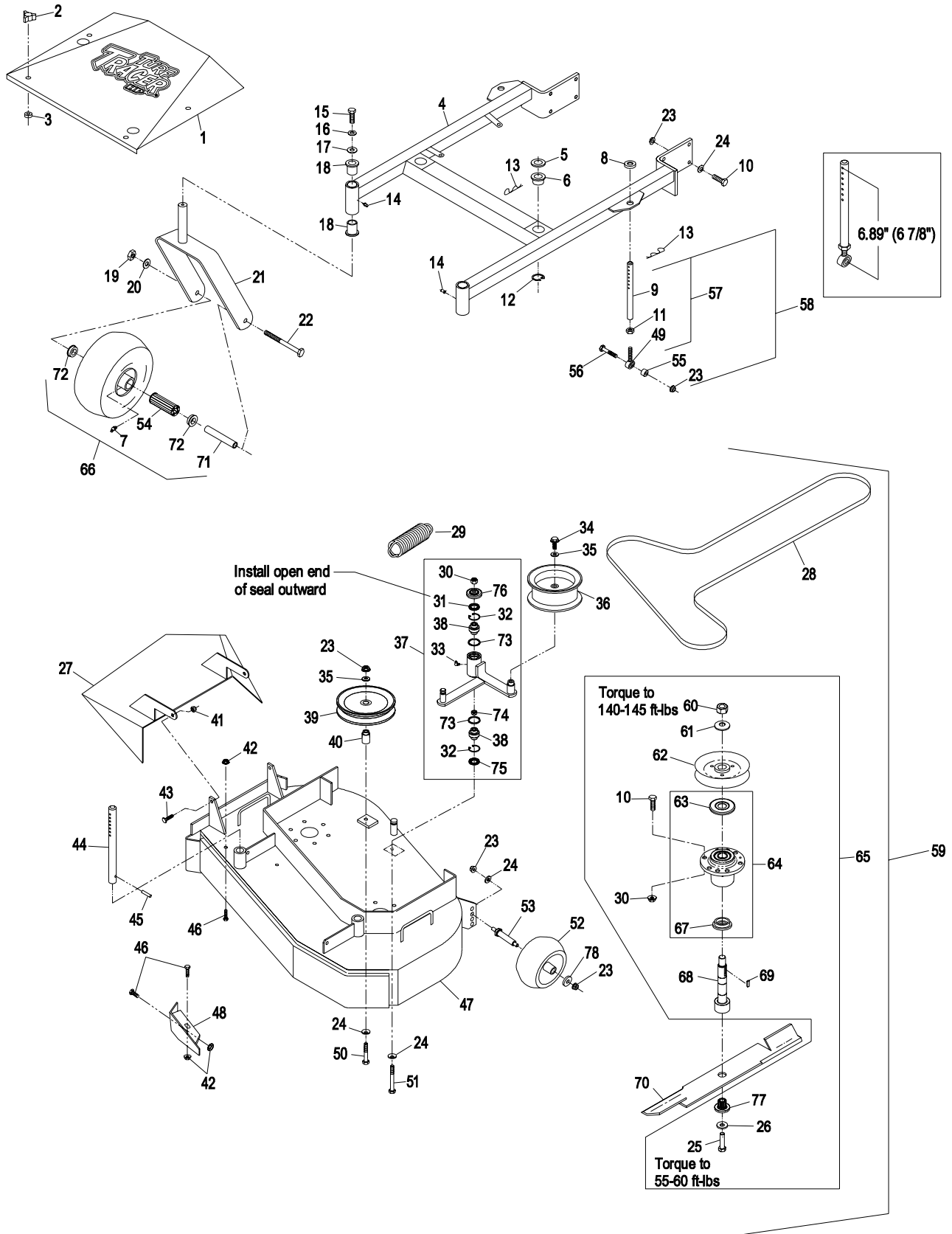

48" MOWER DECK

Item	Part No.	Description	Qty.
1	1-414387	Shield, Belt (1-413101-01) W/Decals	1
2	1-323385	Knob	4
3	1-323417	Washer	4
4	1-414310	Wld, Support (1-412110-01) W/Bushings & Decals	1
5	1-413425	Spacer, Front Deck Support	2
6	1-513336	Bushing, Deck Support	2
7	302-61	Zerk, 45° 1/4-28	2
8	1-323539	Spacer	2
9	1-413525	Link, Deck Support	2
10	323-7	Screw, HH 3/8-16 x 1 1/4	26
11	3219-3	Nut, Hex 3/8-24	2
12	32120-33	Ring, Retaining	2
13	1-806009	Hairpin, Cotter #206	4
14	302-52	Zerk, 1/8-27 Str	2
15	323-6	Screw, HH 3/8-16 x 1	2
16	3253-5	Washer, Lock 3/8 Heavy	2
17	1-373034	Washer	2
18	1-303514	Bearing, Flange	4
19	3217-9	Nut, Hex 1/2-13	2
20	3253-7	Washer, Lock 1/2	2
21	1-522143-01	Wld, Caster	2
22	325-20	Screw, HH 1/2-13 x 6	2
23	3290-357	Nut, Whizlock 3/8-16	17
24	98-5975	Washer, Spring Disk 3/8	15
25	3213-5	Screw, HH 1/2-20 x 2	3
26	1-513435	Washer, Spring Disk 1/2	3
27	103-2431-01	Wld, Discharge Chute	1
28	1-413093	Belt, Deck Drive	1
29	103-3330	Spring, Extension	1
30	3296-39	Nut, Nyloc 3/8-16	19
31	103-3506	Seal, Single Lip	1
32	32120-10	Ring, Retaining	2
33	302-40	Zerk, 90° 1/4-28	1
34	3234-11	Screw, HH FLG 3/8-16 x 1	1
35	3256-24	Washer, 3/8 SAE	3
36	1-413099	Pulley, Idler	1
37★	103-8585	Kit, Idler Arm (103-7356-03) W/Brgs	1
38	103-3504	Bearing, Spherical	2
39	1-613098	Pulley, Idler	2
40	1-413113	Bushing, Idler	2
41	3296-29	Nut, Nyloc 5/16-18	8
42	32128-20	Nut, Whizlock 5/16-18	3
43	322-5	Screw, HH 5/16-18 x 1	2

Item	Part No.	Description	Qty.
44	1-603001	Rod, Deck Support	2
45	1-806332	Rollpin, 1/4 x 1 1/2	2
46	322-2	Screw, HH 5/16-18 x 5/8	3
47	1-414384	Wld, Deck (1-412106-01) W/Decals, Discharge Baffle & Support Rods	1
48	1-522480-01	Baffle, Discharge	1
49	1-613204	Balljoint	2
50	323-13	Screw, HH 3/8-16 x 2 3/4	2
51	98-5961	Screw, HH 3/8-16 x 4 Gr8	1
52◆	1-603299	Roller, Antiscalp	4
53	99-2842	Spacer	4
54	1-513809	Bearing, Roller Bearing	2
55	1-603050	Bushing Spacer	2
56	323-9	Screw, HH 3/8-16x1 3/4	2
57★	1-414521	Link, Assembly	2
58	103-2970-01	Shield, Belt	2
59	3256-3	Washer, 5/16 Std	6
60	1-800017	Bolt, HH 5/16-18 x 3 1/4 Tap	2
61	1-611216	Kit, Link Assembly	2
62	103-0321	Asm, Deck Complete	1
63*	3217-46	Nut, HH 3/4-16 Heavy	3
64	103-2802	Washer, Spring Disc 3/4	3
65+	1-413424	Sheave W/ Hub	3
66+	103-1330	Guard, Bearing Top	3
67	103-8280	Asm, Cutter Housing W/Bearings	3
68	103-9081	Asm, Cutter Housing Complete	3
69	103-2171	Kit, Tire & Wheel Asm W/Spacer	2
70	103-2535	Spacer, Guard Bottom	3
71+□	103-9071	Kit, Spindle	3
72	1-807268	Key, Machine 1/4 x 3/16 x 1	3
73	103-6401	Blade, 16.25 Notched	3
●	103-6391	Blade, 16.25 Mulching	3
	103-6386	Blade, 16.25 Low Lift	3
	103-6381	Blade, 16.25 Solid	3
	103-6396	Blade, 16.25 Extreme	3
74	1-513547	Spacer	2
75	1-513810	Bushing	4
76	106-7159	O-ring	2
77	103-5677	Spacer	1
78	103-3505	Seal, Double, Lip	1
79	103-2916	Guard, Top	1
80	103-3037	Bushing, Splined	3
81	64-8410	Washer	4

Exmark red touch up paint (spray paint - P/N 1-850337 - .6 oz liquid bottle - P/N 103-9140).

- ◇ Kit 103-4051 includes antiscalp roller, spacer, & mounting hardware.
- ★ Link assembly nominal length is 6.89" (or approximately 6 7/8") between center of ball joint and center of furthest hole. See diagram on next page. Initially adjust both links to this dimension, then adjust to where both links are equally supporting rear of mower deck by lengthening one link and shortening the other by an equal amount.
- Requires installation of Micro-Mulch accessory for proper mulching. Mulch kit P/N's MK483Q(48").
- + Apply Mobil HTS grease (P/N 103-5217 1.5 oz packet) (or a food-grade anti-sieze) between the spindles & bearings and spindles & sheaves and under top bearing guard. DO NOT use a copper or nickel based anti-sieze.
- ✖ Idler arm kit also includes items 24 & 51.
- * Use Pro-Lock, Nut Type (P/N 1-840022, .5ml tube) on nut Item 63.
- Kit includes items 25, 26, 63, 64, 72 & 80.

48" MOWER DECK

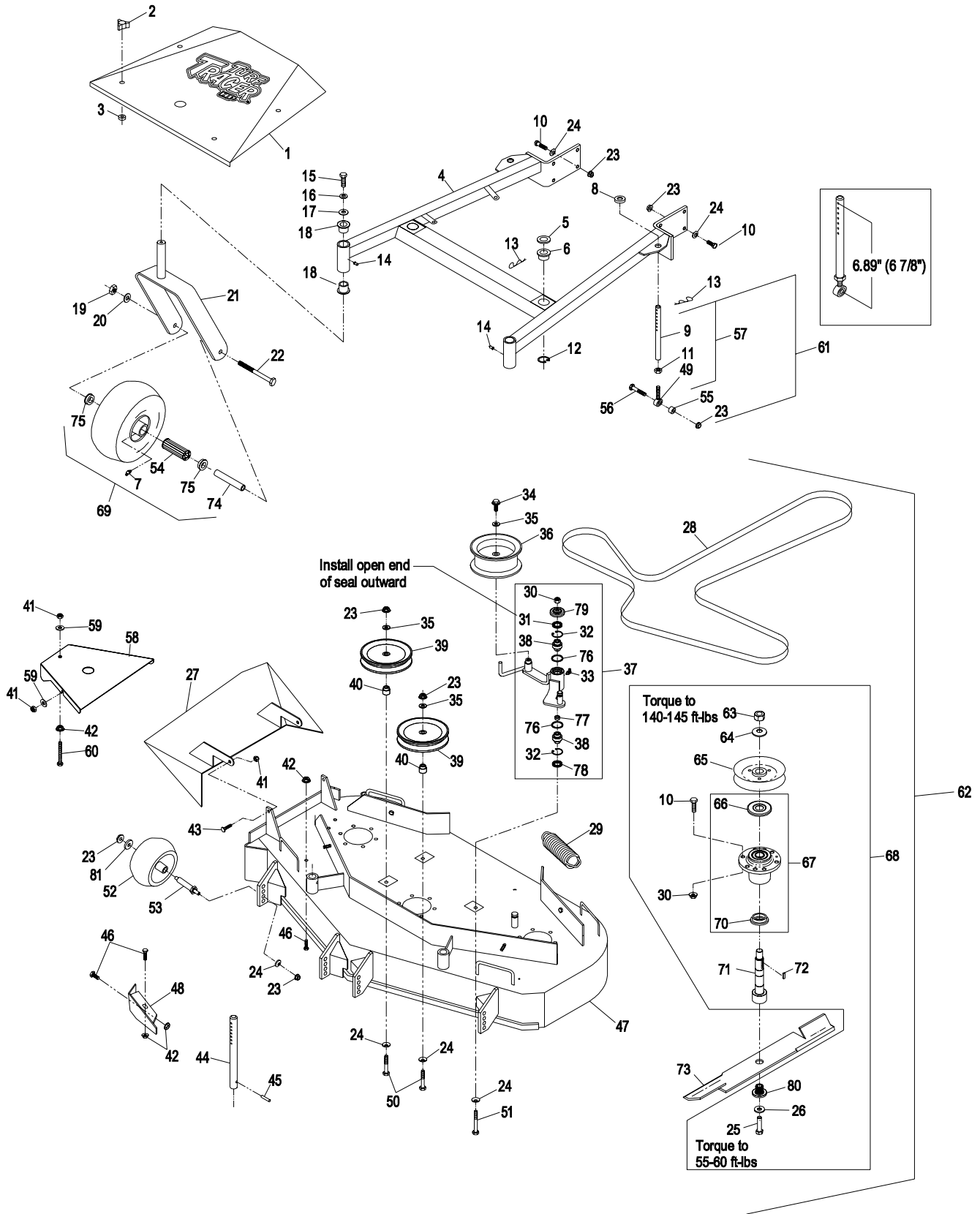

52" MOWER DECK

Item	Part No.	Description	Qty.
1	1-414388	Shield, Belt (1-413303-01) W/Decals	1
2	1-323385	Knob	5
3	1-323417	Washer	5
4	1-414311	Wld, Support (1-412317-01) W/Bushings & Decals.....	1
5	1-413425	Spacer, Front Deck Support.....	2
6	1-513336	Bushing, Deck Support	2
7	1-611216	Kit, Link Assembly.....	2
8	1-323539	Spacer	2
9	1-413525	Link, Deck Support.....	2
10	323-7	Screw, HH 3/8-16 x 1 1/4	26
11	3219-3	Nut, Hex 3/8-24.....	2
12	32120-33	Ring, Retaining	2
13	1-806009	Hairpin, Cotter #206.....	4
14	302-52	Zerk, 1/8-27 Str.....	2
15	323-6	Screw, HH 3/8-16 x 1	2
16	3253-5	Washer, Lock 3/8 Heavy	2
17	1-373034	Washer	2
18	1-303514	Bearing, Flange.....	4
19	3217-9	Nut, Hex 1/2-13.....	2
20	3253-7	Washer, Lock 1/2	2
21	1-522143-01	Wld, Caster	2
22	325-20	Screw, HH 1/2-13 x 6	2
23	3290-357	Nut, Whizlock 3/8-16.....	24
24	98-5975	Washer, Spring Disk 3/8.....	17
25	3213-5	Screw, HH 1/2-20 x 2	3
26	1-513435	Washer, Spring Disk 1/2.....	3
27	1-602571-01	Wld, Discharge Chute	1
28	1-413308	Belt, Deck Drive	1
29	103-3330	Spring, Extension.....	1
30	3296-39	Nut, Nyloc 3/8-16	19
31	103-3506	Seal, Single Lip.....	1
32	32120-10	Ring, Retaining	2
33	302-40	Zerk, 90° 1/4-28	1
34	3234-11	Screw, HH FLG 3/8-16 x 1	1
35	3256-24	Washer, 3/8 SAE	3
36	1-413099	Pulley, Idler	1
37*	103-8585	Kit, Idler Arm (103-7356-03) W/Brgs	1
38	103-3504	Bearing, Spherical.....	2
39	1-613098	Pulley, Idler	2
40	1-413113	Bushing, Idler.....	2
41	3296-29	Nut, Nyloc 5/16-18	10
42	32128-20	Nut, Whizlock 5/16-18	6

Item	Part No.	Description	Qty.
43	322-5	Screw, HH 5/16-18 x 1	2
44	1-603001	Rod, Deck Support	2
45	1-806332	Rollpin, 1/4 x 1 1/2	2
46	322-2	Screw, HH 5/16-18 x 5/8.....	6
47	1-414385	Wld, Deck (1-412313-01) W/Decals, Discharge Baffle & Support Rods.....	1
48	1-602913-01	Baffle, Discharge	1
49	1-613204	Balljoint.....	2
50	323-13	Screw, HH 3/8-16 x 2 3/4.....	2
51	98-5961	Screw, HH 3/8-16 x 4 G8.....	1
52◆	1-603299	Roller, Antiscalp.....	6
53	99-2842	Spacer	6
54	1-513809	Bearing, Roller Bearing.....	2
55	1-603050	Bushing Spacer	2
56	323-9	Screw, HH 3/8-16x1 3/4.....	2
57★	1-414521	Link, Assembly.....	2
58	103-2971-01	Shield, Belt	2
59	103-0322	Asm, Deck Complete	1
60	302-61	Zerk, 45° 1/4-28.....	2
61*	3217-46	Nut, HH 3/4-16 Heavy.....	3
62	103-2802	Washer, Spring Disc 3/4	3
63+	1-413424	Sheave W/ Hub.....	3
64+	103-1330	Guard, Bearing Top	3
65	103-8280	Asm, Cutter Housing W/Bearings.....	3
66	103-9081	Asm, Cutter Housing Complete.....	3
67	103-2171	Kit, Tire & Wheel Asm W/Spacer	2
68	103-2535	Spacer, Guard Bottom	3
69+□	103-9071	Kit, Spindle	3
70	1-807268	Key, Machine 1/4 x 3/16 x 1	3
71	3256-3	Washer, 5/16 Std.....	8
72	103-6402	Blade, 18.00 Notched	3
●	103-6392	Blade, 18.00 Mulching	3
	103-6387	Blade, 18.00 Low Lift	3
	103-6382	Blade, 18.00 Solid.....	3
	103-6397	Blade, 18.00 Extreme	3
73	1-513547	Spacer	2
74	1-513810	Bushing	4
75	106-7159	O-ring	2
76	103-5677	Spacer	1
77	103-3505	Seal, Double, Lip	1
78	103-2916	Guard, Top	1
79	103-3037	Bushing, Splined.....	3
80	63-8410	Washer	6

Exmark red touch up paint (spray paint - P/N 1-850337 - .6 oz liquid bottle - P/N 103-9140).

- ◇ Kit 103-4051 includes antiscalp roller, spacer, & mounting hardware.
- ★ Link assembly nominal length is 6.89" (or approximately 6 7/8") between center of ball joint and center of furthest hole. See diagram on next page. Initially adjust both links to this dimension, then adjust to where both links are equally supporting rear of mower deck by lengthening one link and shortening the other by an equal amount.
- Requires installation of Micro-Mulch accessory for proper mulching. Mulch kit P/N's MK523Q(52").
- + Apply Mobil HTS grease (P/N 103-5217 1.5 oz packet) (or a food-grade anti-sieze) between the spindles & bearings and spindles & sheaves and under top bearing guard. DO NOT use a copper or nickel based anti-sieze.
- ✖ Idler arm kit also includes items 24 & 51.
- * Use Pro-Lock, Nut Type (P/N 1-840022, .5ml tube) on nut Item 61.
- Kit includes items 25, 26, 61, 62, 70 & 79.

52" MOWER DECK

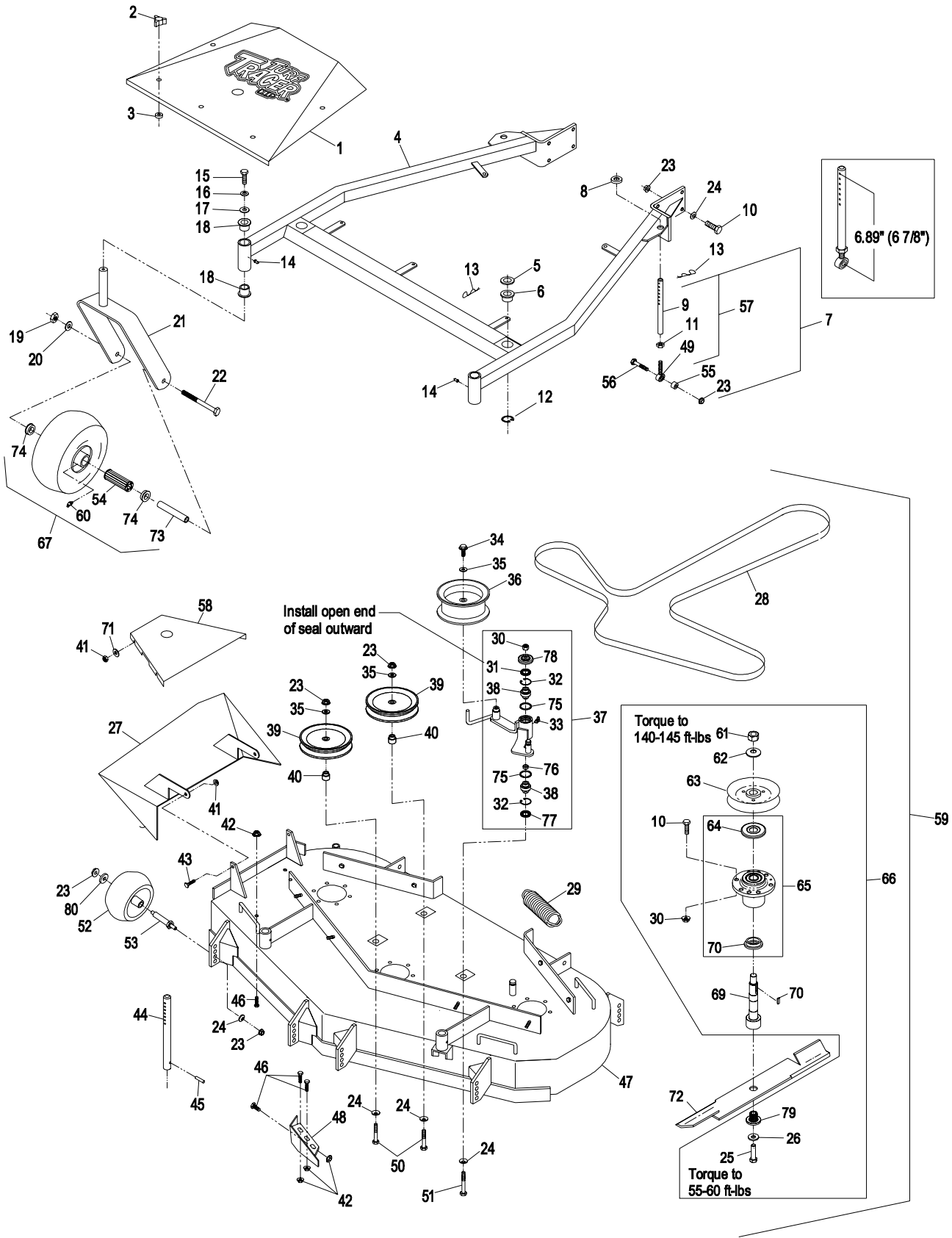

ENGINE DECK GROUP

Item	Part No.	Description	Qty.
1◇	323-11	Screw, HH 3/8-16 x 2-1/4	2
✘	323-11	Screw, HH 3/8-16 x 2-1/4	1
2◇	98-5975	Washer, Spring Disc 3/8	11
✘	98-5975	Washer, Spring Disc 3/8	13
3	103-3506	Seal, Single Lip	1
4	1-513034	Bearing, Pivot	2
5	302-19	Zerk, 1/4-28 Str	1
6	1-414143	Asm, Bellcrank (1-412285-03) W/Brgs	1
7	322-6	Screw, HH 5/16-18 x 1-1/4	1
8	321-6	Screw, HH 1/4-20 x 1	2
9	32128-33	Nut, Whizlock 1/4-20	4
10	1-523498	Spring, Motion Control	1
11	103-7398	Spring, Belt Tension	1
12	1-543007	Spacer	1
13	1-213069	Washer	1
14	3296-29	Nut, Nyloc 5/16-18	3
15	3256-4	Washer, 3/8 Std	2
16	3290-357	Nut, Whizlock 3/8-16	19
17	1-413282	Linkage	1
18	1-806003	Hairpin, Cotter	1
19	109-1297	Asm, Deck (103-7345-01) W/Decals	1
20	323-4	Screw, HH 3/8-16 x 3/4	2
21	1-633068	Arm	1
22	32128-20	Nut, Whizlock 5/16-18	15
23	1-303334	Washer, Spring Disc 5/16	5
24◇	1-322110	Wld, Belt Guide	1
25◇	322-7	Screw, HH 5/16-18 x 1-1/2	3
✘	322-7	Screw, HH 5/16-18 x 1-1/2	4
26◇	322-9	Screw, HH 5/16-18x 1-3/4	1
27	3256-3	Washer, 5/16 Std	2
28◇	1-323366	Ring, Split	1
29	3296-39	Nut, Nyloc 3/8-16	5
30◇	323-6	Screw, HH 3/8-16 x 1	8
✘	323-6	Screw, HH 3/8-16 x 1	10
31	1-412080-01	Mount, Wheel Motor (36")	2
	1-412082-01	Mount, Wheel Motor (48" & 52")	2
32	3234-12	Screw, HH FLG 3/8-16 x 3/4	8
33	1-602997	Hub, W/Studs	2
	1-633926	Stud, Wheel 1/2-20	8
34	1-413473	Asm, Wheel & Tire (36")	2
	1-413474	Tire 16 x 6.50-8 (36")	2
	1-613263	Asm, Wheel & Tire (48" & 52")	2
	1-613264	Tire 16 x 7.50-8 (48" & 52")	2
	1-603715	Wheel	2
35	242-50	Nut, Lug 1/2-20	8
36	32136-5	Nut, Slotted 3/4-16	2
37	1-806800	Pin, Cotter 9/64 x 1-1/2	2
38	1-807264	Key, 1/4 x 1/4 x 2-5/8	1
39+	103-6309	Asm, Drive Sheave	1
40	1-603609	Bushing	1
41	1-373034	Washer	2
42	1-603610	Washer, Spring Disk 7/16	2
43▽	3212-10	Screw, HH 7/16-20 x 2-1/2	1
44	3256-24	Washer, 3/8 SAE	2

Item	Part No.	Description	Qty.
45	1-603843	Pulley, Idler	1
46	1-603496	Bushing, Idler	1
47	103-8599	Spring, Extension	1
48	109-1296	Kit, Idler Arm (109-1208-03) W/Brgs	1
49	1481	Zerk, 45° 1/4-28	2
50	98-5961	Screw, HH 3/8-16 x 4 Gr8	1
51	323-9	Screw, HH 3/8-16 x 1-3/4	2
52◇	1-809069	Screw, HH #10-24 x 7/8	1
53◇	1-323365	Chain, Cold Start	1
54◇	3256-14	Washer, #10 Std	1
55◇	3296-2	Nut, Nyloc #10-24	1
56	1-807272	Key, 5mm x 5mm x 25mm	2
57▽	1-803050	Setscrew, 5/16-18 x 3/4	4
58	109-1057	Belt, Pump Drive	1
59+	1-413010	Sheave, Pump Drive	2
60	103-6317	Belt, Blade Clutch	1
61	1-807259	Key, 1/4 x 1/4 x 1	1
62+	103-6308	Sheave W/Shaft	1
63+	1-413111	Bearing, Clutch	2
64	32120-8	Ring, Retaining	2
65	1-413012	Spacer, Bearing	1
66	1-523157	Washer, Spacer	1
67	1-413049-01	Plate, Clutch Pivot	1
68	322-5	Screw, HH 5/16-18 x 1	6
69	1-413207	Pivot, Bearing	2
70	1-414418	Asm, Clutch Arm (1-412417-03) W/Bearings	1
71	1-413235	Washer, Spacer	1
72	1-412138-03	Wld, Pivot Pin	1
73	322-3	Screw, HH 5/16-18 x 3/4	3
74	1-413062	Band, Brake	1
75	323-8	Screw, HH 3/8-16 x 1 1/2	2
76	103-6310	Wld, Belt Guide	1
77+	1-412031	Sheave W/Drum (36" & 52")	1
	1-412028	Sheave W/Drum (48")	1
78▽	1-800521	Screw, HH 3/8-24 x 1	1
79	1-413009-01	Plate, Guard	1
80	103-2056	Shield, Trailing	1
81	1-413510	Clip, Loom 1/2	2
82	1-413511	Hanger, Drag Shield	2
83✘	103-3442	Battery, Cover (1-543891) W/Decal	1
84✘	1-543792	Wingnut, Nyloc 1/4-20	2
85✘	1-413541	Trim-Lok, 1/8 x 5	1
86✘	103-1098	Stand W/ Trim-Lok	1
87✘	1-543882	Bolt, Hold Down	2
88	323-7	Screw, HH 3/8-16 x 1 1/4	1
89	32120-10	Ring, Retaining	2
90	1-807019	Key, Woodruff 1 x 1/4	2
91	103-3504	Bearing, Spherical	2
92	106-7159	O-ring	2
93	103-5677	Spacer	1
94	103-3505	Seal, Double, Lip	1
95	103-2916	Guard, Top	1

Exmark red touch up paint (spray paint - P/N 1-850337 - .6 oz liquid bottle - P/N 103-9140).

◇ Manual start only.

✘ Electric start only.

▽ Use Pro-Lock (nut type, Part no. 1-840022, 5 ml tube):

- on setscrew threads.
- on sheave retaining bolt in engine crankshaft.
- on sheave retaining bolt on clutch arm.

+ Apply antiseize:

- between engine crankshaft and pump and blade drive sheave.
- between sheave w/shaft and bearing bores and sheave w/drum.
- between pump shafts and sheaves.

ENGINE DECK GROUP

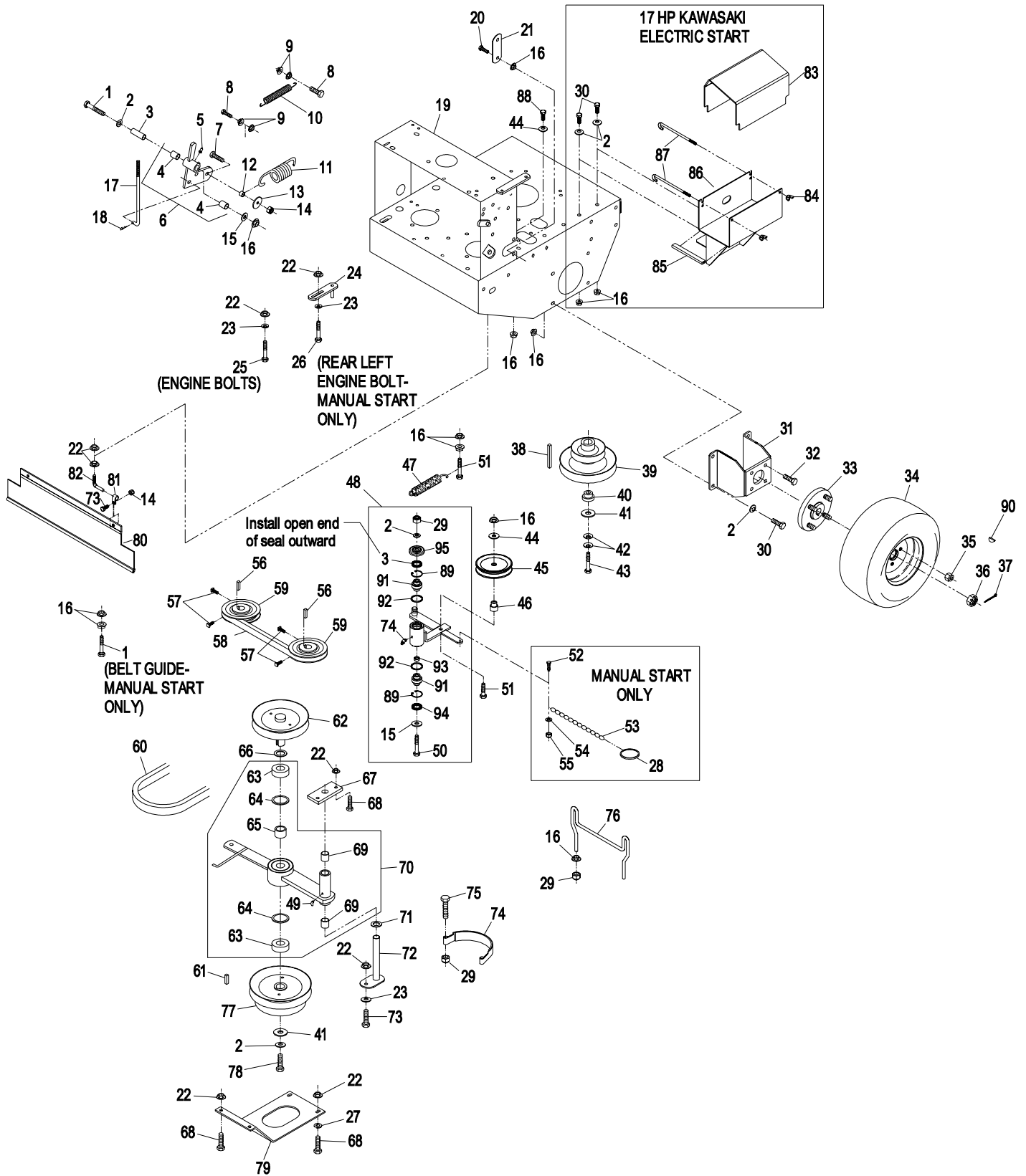

ENGINE DECK GROUP (cont.)

Item	Part No.	Description	Qty.
1	1-323245	Spring	1
2	32128-20	Nut, Whizlock 5/16-18	20
3	3296-29	Nut, Nyloc 5/16-18	2
4	1-613089	Tab, Spring Extension	2
5	1-603693	Spring, Extension	2
6	1-413201-01	Shield, Hydro	2
7	323-16	Screw, HH 3/8-16 x 4	6
8	302-19	Zerk, 1/4-28 Str	2
9	322-3	Screw, 5/16-18 x 3/4	4
10	1-805005	Washer, Lock 5/16 Heavy	4
11	3256-2	Washer, 1/4 Std	6
12	3290-357	Nut, Whizlock 3/8-16	15
13	1-323195-01	Spacer, Shield	4
14	1-633102	Bearing, Side Flange	2
15	1-323197-01	Spacer, Shield	4
16	1-603737	Bolt, Neutral Return	2
17	103-0265	Spring, Neutral Return	2
18	1-603735	Bushing, Nylon	2
19	3219-2	Nut, Hex 5/16-24	7
20	1-303105	Yoke	2
21	1-808280	Clevis Pin, 5/16 x 1	2
22	1-806003	Hairpin, Cotter	5
23	3220-2	Nut, Jam 5/16-24	2
24	1-413350	Rod, Control	2
25	1-412203-01	Wld, Crank	1
26	1-633131	Yoke, Brake Linkage	1
27	3256-23	Washer, 5/16 SAE	7
28	1-603676	Swivel, Short	2
29	1-800016	Bolt, HH 5/16-18 x 1-1/4 Tap	2
30	1-413489	Linkage, Lower Brake	1
31▽	1-803022	Setscrew, 5/16-18 x 5/8	2
32	103-1190-01	Wld, Arm LH	1
33	103-4796-01	Wld, Arm RH	1
34	3218-3	Nut, Jam 3/8-16	1
35	322-6	Screw, HH 5/16-18 x 1-1/4	3
36	3272-5	Pin, Cotter 3/32 x 1/2	2
37	1-603903	Spacer	1

Item	Part No.	Description	Qty.
38	1-403180	Screw, HH 5/16-18 x 1 3/8	2
39▽	1-809056	Screw, SH Shld 5/16-18 x 1 3/8	2
40	3256-24	Washer, 3/8 SAE	4
41	1-413151	Knob	1
42	1-323161	Spring	1
43	103-2085-03	Wld, Brake (36")	1
	103-2004-03	Wld, Brake (48" & 52")	1
44+	92-6877	Valve, Oil Drain	1
45	103-1966	Adapter, M20-2.5/ 3/8 NPT	1
46	1-413492	Linkage, Upper Brake	1
47◇	323-23	Screw, HH 3/8-16 x 4 1/2	1
✖	323-16	Screw, HH 3/8-16 x 4	1
48◇	3296-39	Nut, Nyloc 3/8-16	2
✖	3296-39	Nut, Nyloc 3/8-16	1
49	103-1148	Rod, Drive Lever	2
50	323-8	Screw, HH 3/8-16 x 1 1/2	2
51	103-1167	Joint, 3/8 LH Ball End	2
52	103-1166	Tube, Pump Link Spacer	2
53	3220-16	Nut, Jam 3/8-24 LH	2
54◇	323-16	Screw, HH 3/8-16 x 4	1
✖	323-23	Screw, 3/8-16 x 4 1/2	1
55	1-303020	Grip, Lever	1
56	323-9	Screw, HH 3/8-16 x 1 3/4	2
57	323-4	Screw, HH 3/8-16 x 3/4	3
58	103-3495	Lever, Park Brake (1-412501-03) W/Decals	1
59	1-414504	Asm, Park Brake Bracket (1-412502-03) W/Bushings	1
60	1-413347	Sleeve, Bushing	2
61	1-413344	Bushing, Pivot	1
62	323-10	Screw, HH 3/8-16 x 2	1
63	1-414508	Bellcrank, W/ Bushings	1
64	1-303548	Bushing, Plastic	1
65	32128-21	Nut, Whizlock 3/8-16	1
66	103-2399	Pin, Clevis Spring 3/8	1
67	3218-2	Nut, Jam 5/16-18	2
68	106-7022	Hose, Oil Drain	1

Exmark red touch up paint (spray paint - P/N 1-850337 - .6 oz liquid bottle - P/N 103-9140).

▽ Use Pro-Lock nut type, Part No. 1-840022 (.5 ml tube) on shoulder bolts & setscrew threads.

+ Use a Teflon Pipe Sealant or equivalent on pipe threads.

◇ Manual start only.

✖ Electric start only.

ENGINE DECK GROUP (cont.)

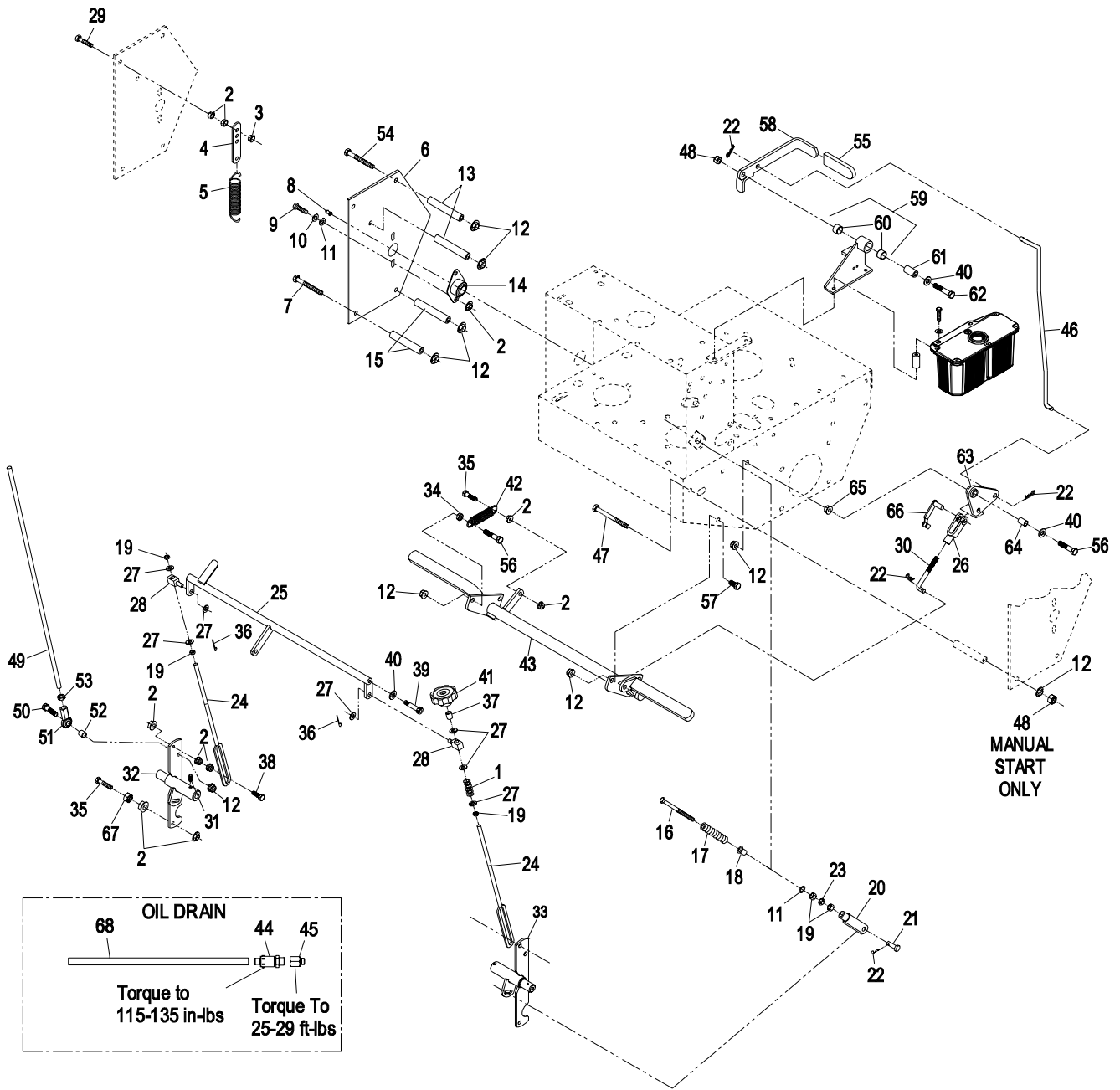

ECS UPPER HANDLES and CONTROLS

Item	Part No.	Description	Qty.
1	1-303020	Grip.....	1
2	1-414234	Asm, Lever (1-412295-03) W/Grip.....	1
3	3256-4	Washer, 3/8 Std.....	2
4	323-11	Screw, HH 3/8-16 x 2-1/4.....	1
5	322-9	Screw, HH 5/16-18 x 1 3/4.....	2
6	3296-39	Nut, Nyloc 3/8-16.....	1
7	1-806003	Hairpin, Cotter.....	3
8	103-1149	Link, Blade Engagement.....	1
9	1-413279	Turnbuckle.....	1
10	3217-7	Nut, Hex 3/8-16.....	1
11+	103-1566-03	Wld, OPC Lever LH.....	1
12▽	1-803322	Setscrew, 5/16-24 x 5/16.....	2
13	1-303365	Bushing, Nylon.....	2
14	103-0769-03	Wld, OPC Lever Axle.....	1
15	1-303363	Spring, Opc Extension.....	1
16+	103-1567-03	Wld, OPC Lever RH.....	1
17	1-807513	Bolt, Carriage #10-24 x 1/2.....	2
18	1-513592	Knob, Red Throttle.....	1
19	1-633696	Cable, Throttle.....	1
20	3296-2	Nut, Nyloc #10-24.....	2
21	103-0770-03	Wld, ECS Upper Handle.....	1
22	103-0815	Grip, Handle Bar.....	2
23	1-413152	Bearing.....	4
24	103-2466-03	Lever, Drive LH.....	1
25	103-0027	Bushing, Drive Lever.....	2
26	321-14	Screw, HH 1/4-20 x 2 3/4.....	2
27*	32128-33	Nut, Whizlock 1/4-20.....	12
◇	32128-33	Nut, Whizlock 1/4-20.....	14
28	103-0464	Pin, Spring 1/8 x 1/2.....	2
29	3256-22	Washer 1/4 SAE.....	10
30	1-303435	Washer, Spring Disc 1/4.....	6
31	103-1371	Asm, Thumb Latch RH (Shown).....	1
	103-1372	Asm, Thumb Latch LH (Not Shown).....	1
32▽	103-0235	Screw, HH 1/4-20 x 1-1/8 W/Nylon.....	2
33	103-2465-03	Lever, Drive RH.....	1
34	3290-357	Nut, Whizlock 3/8-16.....	4
35	98-5975	Washer, Spring Disc 3/8.....	4
36	323-6	Screw, HH 3/8-16 x 1.....	4
37	3220-3	Nut, Jam 3/8-24.....	4

Item	Part No.	Description	Qty.
38	322-10	Screw, 5/16-18 x 2.....	2
39	1-603716	Washer, Friction Disc.....	1
40	1-323244	Washer, Friction.....	2
41*	103-2457	Asm, Console (103-0546-03)W/ Decals..	1
◇	103-2458	Asm, Console (103-0546-03)W/ Decals..	1
42	103-0773	Wld, Speed Shift.....	1
43	103-0423	Knob Nyloc 3/8-16.....	1
44	3296-29	Nut, Nyloc 5/16-18.....	4
45	1-323245	Spring, Compression.....	2
46	3256-23	Washer 5/16 SAE.....	5
47*	321-3	Screw, HH 1/4-20 x 5/8.....	10
◇	321-3	Screw, HH 1/4-20 x 5/8.....	12
48	1-413225	Rod, Speed Control.....	1
49	3220-2	Nut, Jam 5/16-24.....	1
50	1-303105	Yoke.....	1
51	1-808280	Pin, Clevis 5/16 x 1.....	1
52	109-0346	Cap, Fuel.....	1
53	103-2893	Asm, Fuel Tank W/Fitting.....	1
54+	1-633023	Stud, Fuel Tank.....	2
55	1-633349	Spring, Fuel Tank.....	2
56	1-805005	Washer, Lock 5/16 Heavy.....	2
57	322-3	Screw, HH 5/16-18 x 3/4.....	2
58	103-1796	Cable, Choke.....	1
59	103-1797-01	Bracket, Choke Cable.....	1
60	1-303077	Clamp, Fuel Line.....	4
61	109-0306	Hose, Fuel Line 6".....	1
62	1-603770	Valve, Fuel.....	1
63	109-0293	Hose, Fuel Line 8.5".....	1
64	Kawasaki	PN 41019-1055 Filter W/6" Fuel Line.....	1
65	3296-47	Nut, Nyloc 5/16-18 Thin.....	2
66	1-303287	Tie, Cable 5 1/2.....	1
67	103-2513	Asm, Drive Lever RH.....	1
	103-2514	Asm, Drive Lever LH.....	1
68	103-2463	Balljoint.....	2
69	103-0503	Bracket, Shifter Slide.....	1
70	103-0489-03	Bracket, Opc Axle.....	1
71	3219-3	Nut, Hex 3/8-24.....	2
72▽	103-2605	Fitting, Fuel Bulkhead W/Strainer.....	1

Exmark red touch up paint (spray paint - P/N 1-850337 - .6 oz liquid bottle - P/N 103-9140).

▽ Use Pro-Lock nut type, Part no. 1-840022 (.5cc tube) on setscrew threads, on thumb latch screws and on fuel fitting.

+ Use Pro-Lock retaining type, Part no. 1-840023 (.5cc tube) on inside of bore of OPC hub and on fuel tank studs, where studs are inserted into tank.

◇ Manual start only.

* Electric start only.

ECS UPPER HANDLES and CONTROLS

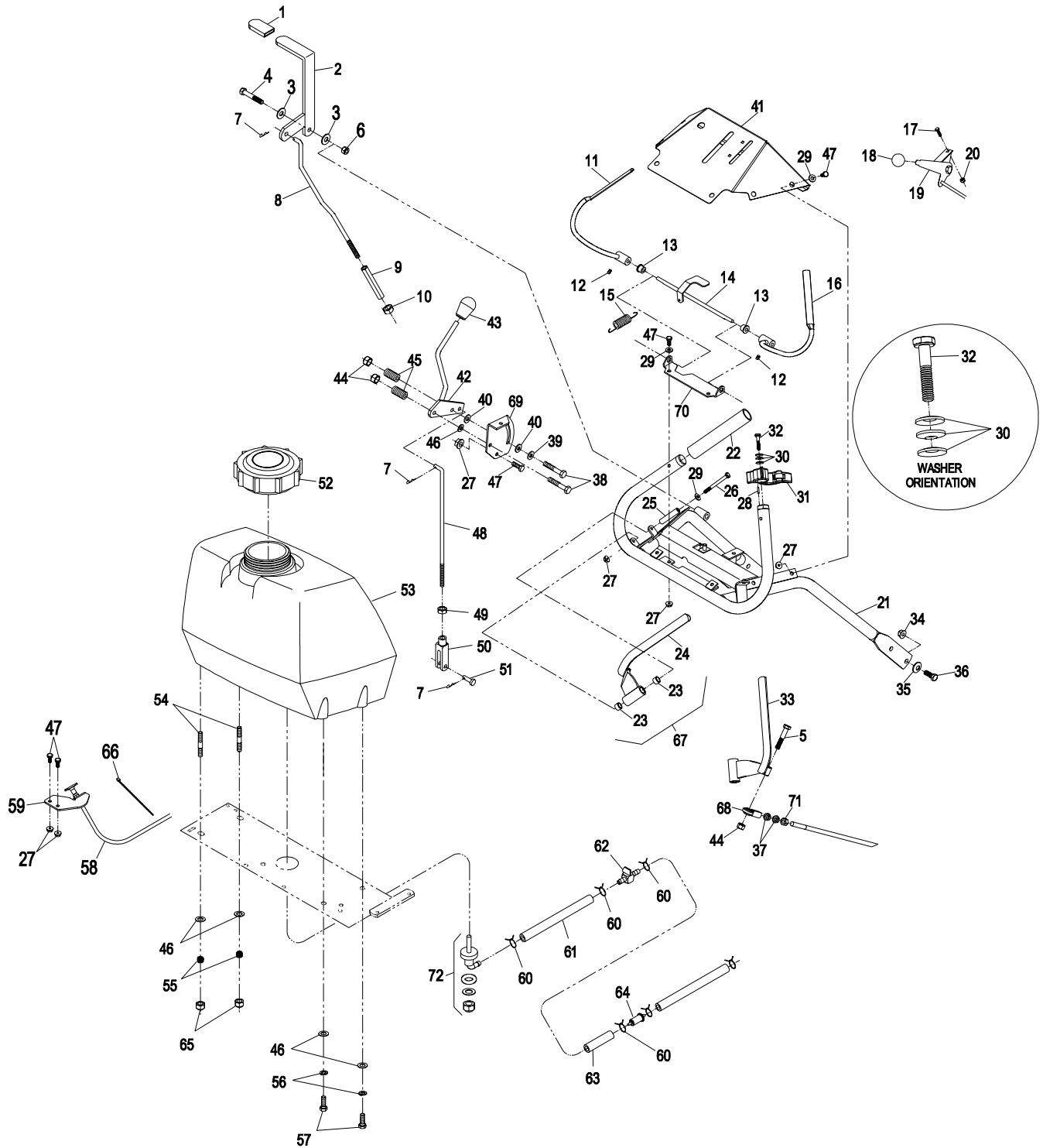

ELECTRICAL GROUP

Item	Part No.	Description	Qty.
1	1-543070	Switch, Ignition	1
	1-603511	Key, Ignition.....	1
	103-2106	Key, Exmark Logo	1
2	1-303335	Tie, Plastic Large.....	2
3	321-3	Screw, HH 1/4-20 x 5/8.....	2
4	3296-42	Nut, Nyloc 1/4 20.....	3
5	1-323442-01	Bracket, Fuse	1
6	1-816001	Fuse, 20A.....	2
7	321-4	Screw, HH 1/4-20 x 3/4.....	5
8	1-613198	Module	1
9	3256-22	Washer, 1/4 SAE.....	1
10●	103-2006	Harness, Wiring.....	1
11	1-633306	Cable, Solenoid/Starter +.....	1
12	32128-33	Nut, Whizlock 1/4-20.....	5
13	1-603490	Cable, Battery +.....	1
14	1-513075	Switch, 12V Solenoid.....	1
15	1-543393	Insulator, Solenoid +.....	3
16	1-603727	Clip, Loom	1
17	1-543391	Insulator, Battery +	1
18	1-303287	Tie, Cable.....	2
19	1-413540	Battery Cable.....	1
20	1-543390	Insulator, Battery -	1
21	3290-500	Screw, PPH #10-24 x 5/8	8
22	3219-14	Nut, Hex #10-32	2
23	3253-4	Washer, Lock 5/16.....	2
24	3220-2	Nut, Jam 5/16-24.....	2
25	3253-17	Washer, Lock 3/16.....	2
26	3256-2	Washer, 1/4 Std.....	2
27	1-633181	Plate, Tapped	4
28	103-0498	Nut, Ignition Switch.....	1
29	1-513051	Switch, N.O.	2
30	1-633111	Switch N.O / N.C.	1
31	1-513152	Switch, N.C.....	1

● Use dielectric grease on all electrical connectors.

ELECTRIC START

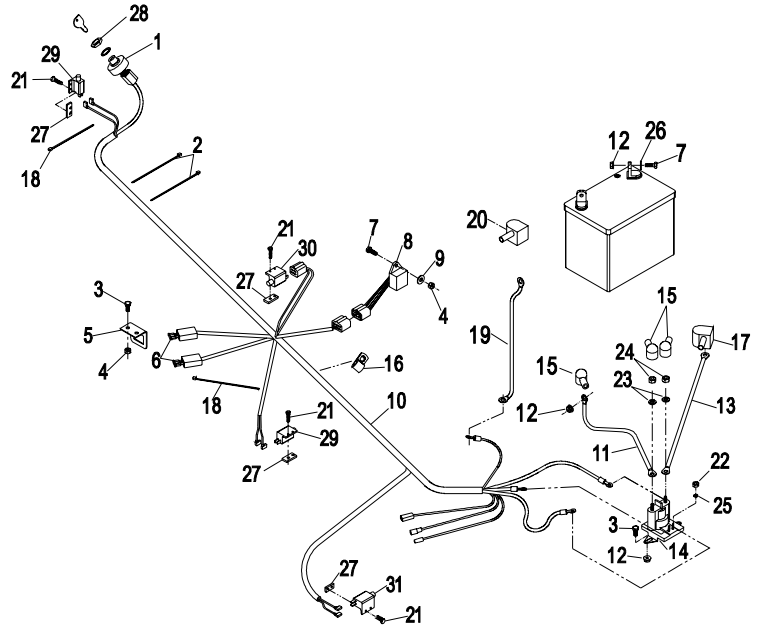

Item	Part No.	Description	Qty.
1	3290-500	Screw, HH #10-24 x 5/8.....	8
2	1-513051	Switch, N.O.	4
3	1-633181	Plate, Tapped	4
4	1-303287	Tie, Cable 5 1/2.....	5
5	1-323229	Clip, Loom 3/8	1
6	103-2005	Harness, Wiring.....	1
7	1-805004	Washer, Lock 1/4 Heavy.....	1
8	1-323430	Module, Interlock	1
9	3296-42	Nut, Nyloc 1/4-20.....	1
10	3256-22	Washer, 1/4 SAE.....	1
11	321-4	Screw, HH 1/4-20 x 3/4.....	1
12	1-403121	Switch, On/Off	1
	1-603511	Key, Ignition.....	1
	103-2106	Key, Exmark Logo	1
13	3256-14	Washer, #10 Std.....	1
14	1-303335	Tie, Cable 7 5/16.....	2
15	103-0498	Nut, Ignition Switch.....	1
16	1-413510	Clip, Loom 1/2	1
17	33114-016	Screw, HH M8-1.25 x 16mm..	1
18	33113-016	Screw, HH M6-1.00 x 16mm..	1

● Use dielectric grease on all electrical connectors.

MANUAL START

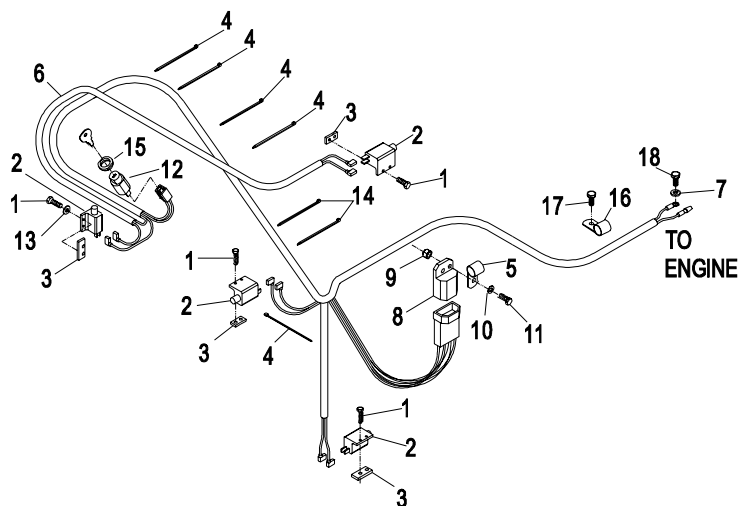

WIRING DIAGRAMS

15 & 17 HP KAWASAKI

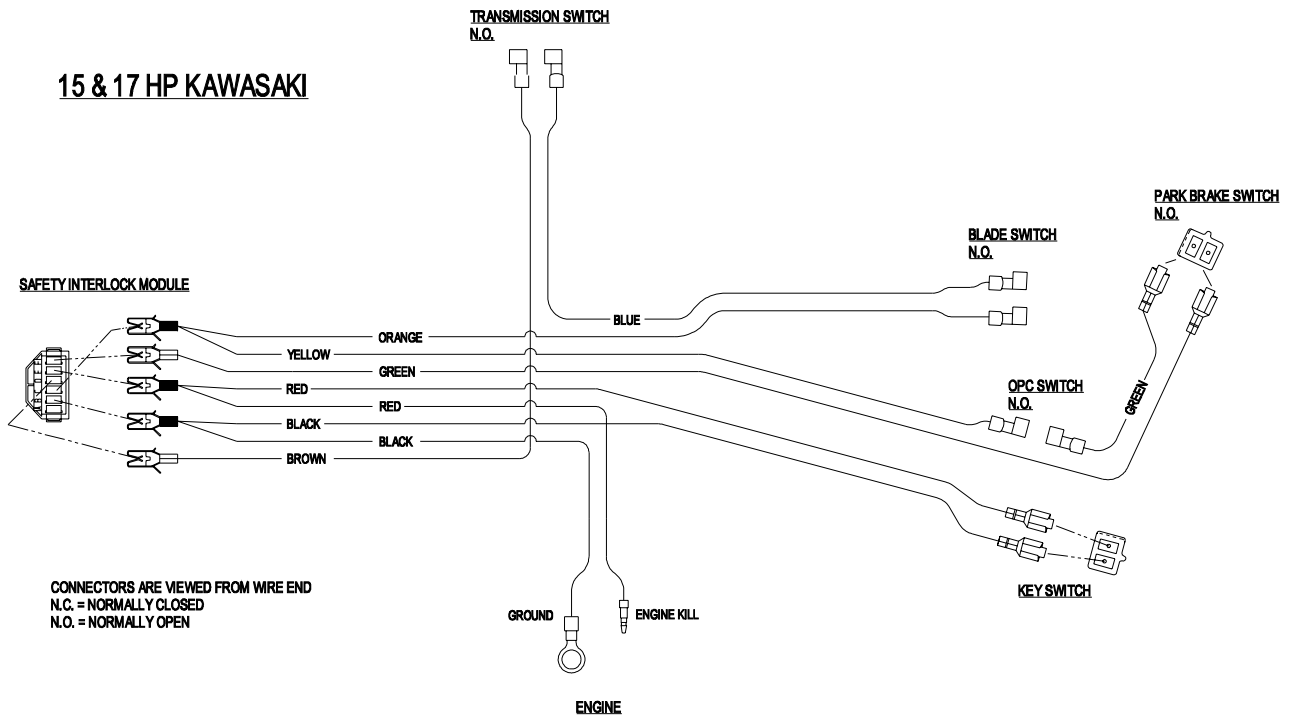

19 HP KAWASAKI ELECTRIC START

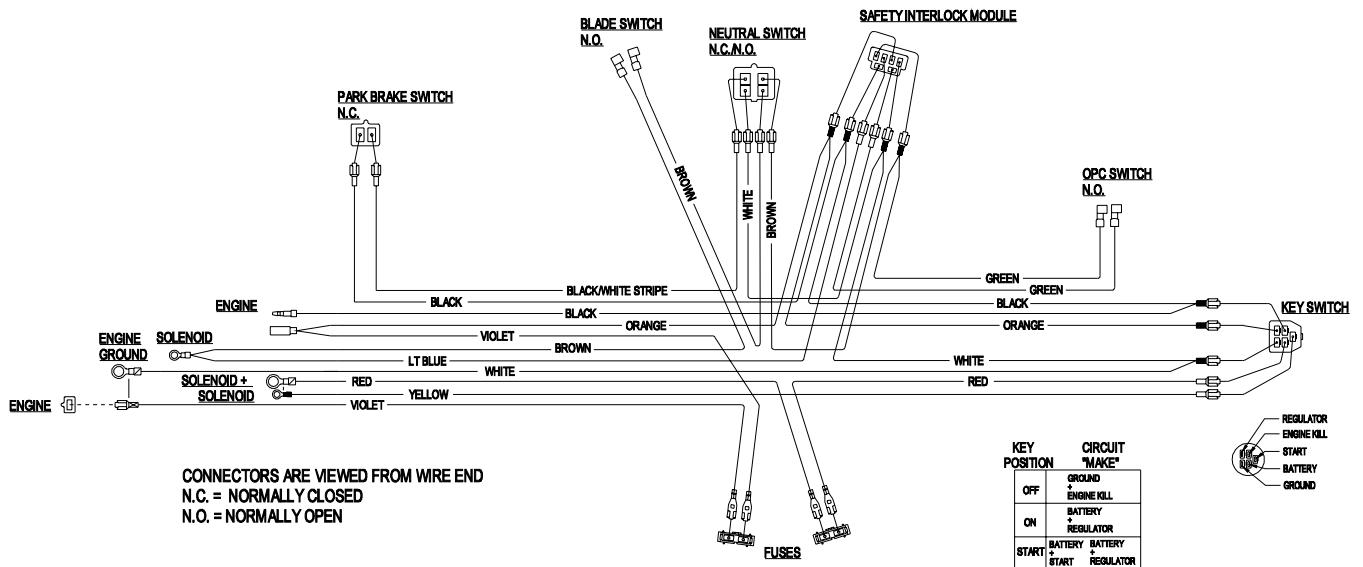

DECALS

Item	Part No.	Description	Qty.
1	103-2242	Decal, ECS Instruction LH.....	1
2	103-2243	Decal, ECS Instruction RH.....	1
3	1-303520	Decal, Trivantage.....	1
4	103-7491	Decal, Bolt Torque	1
5	1-303508	Decal, Discharge Warning.....	1
6	1-413421	Decal, Indicator	1
7	103-2103	Decal, Park Brake	1
8*	103-1976	Decal, Ecs Console.....	1
9	1-523552	Decal, Hydraulic Tank	1
10	103-2939	Decal, Tthp Model.....	1
11	103-1798	Decal, Throttle.....	1
12	103-2882	Decal, Exmark Logo.....	1
13	1-303517	Decal, Belt Drive	1
14◇	103-1977	Decal, Ecs Console.....	1
15	1-513746	Decal, Muffler.....	2

Item	Part No.	Description	Qty.
16	1-413214	Decal, Tracking.....	1
17	1-553049	Decal, Mower Deck.....	1
18	1-323411	Decal, Commercial 36.....	1
19	1-403131	Decal, Commercial 48.....	1
20	1-403132	Decal, Commercial 52.....	1
21	1-403143	Decal, Sulky Warning.....	1
22*	1-513747	Decal, Battery	1
23	103-4935	Decal, Drive Wheel Release	1
24	98-5954	Decal, Missing Cover (36").....	1
	98-5954	Decal, Missing Cover (48" & 52")	3
25	1-413206	Decal, Belt Routing (36").....	1
26	1-413327	Decal, Belt Routing (48" & 52")	1
27	1-403005	Decal, Danger.....	2
	103-2461	Decal Kit	

- ◇ Manual start only.
- * Electric start only.

DECALS

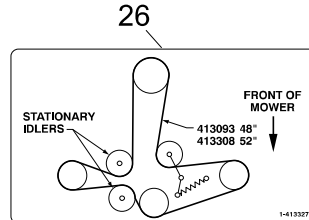
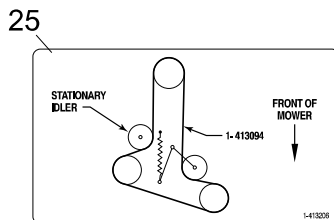
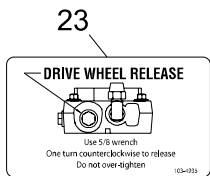
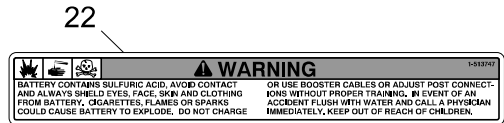
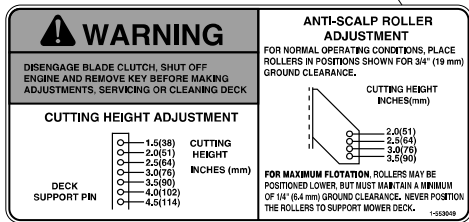
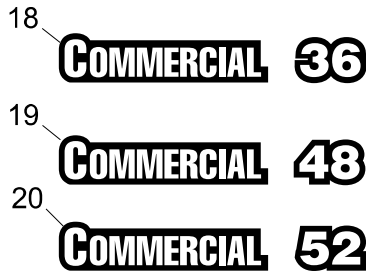
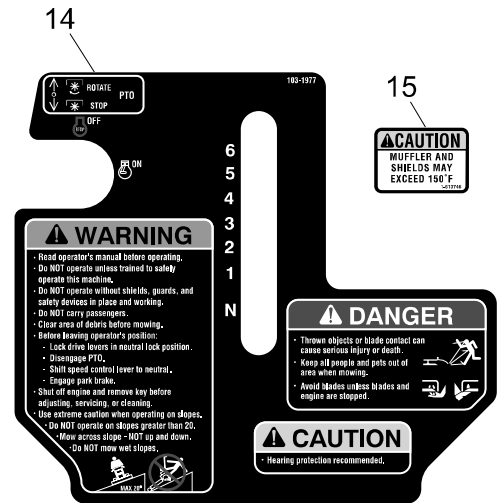
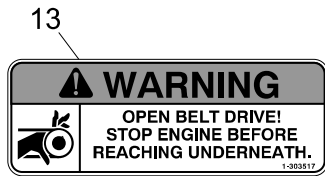
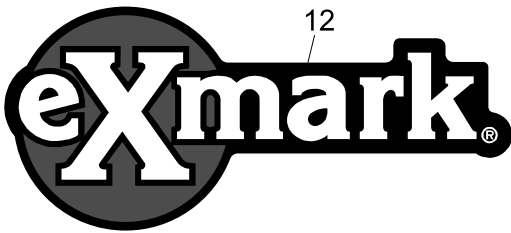
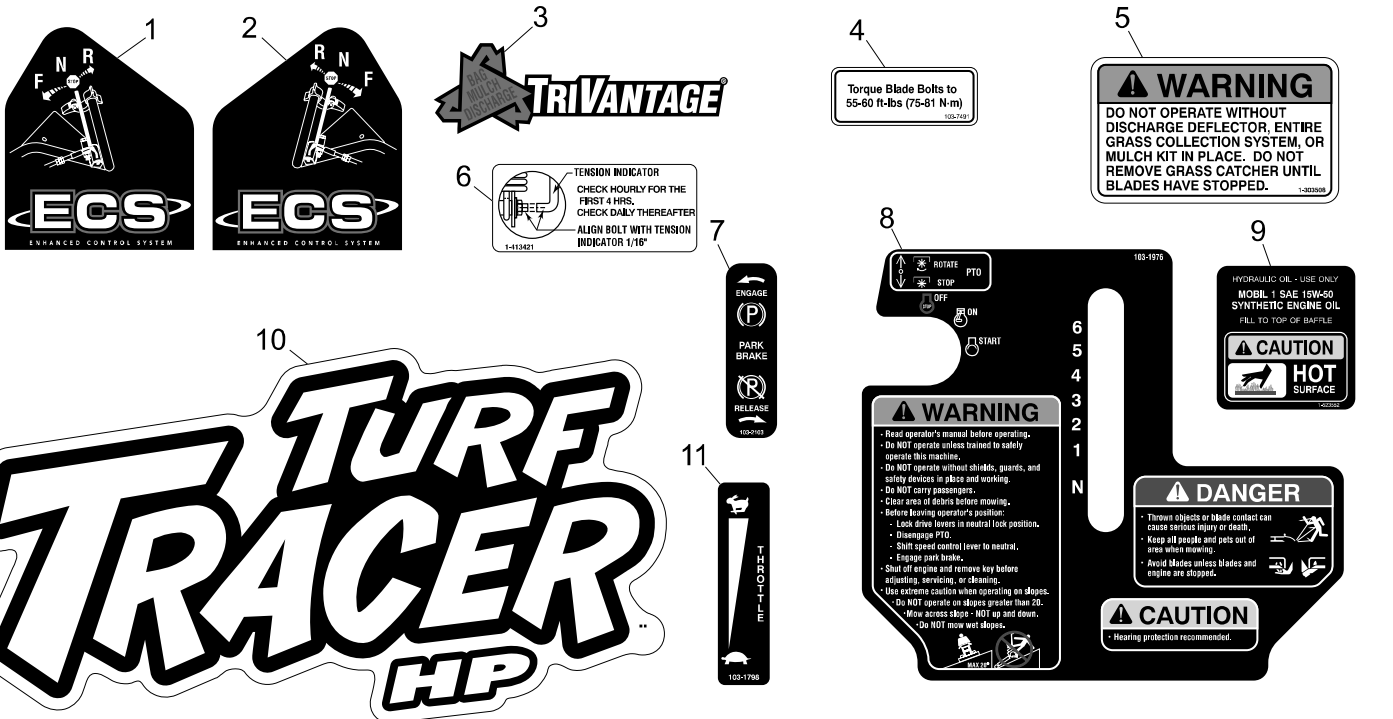

HYDRAULIC GROUP

Item	Part No.	Description	Qty.
1	1-603991	Fitting, Straight Connector.....	4
	1-603919	O-Ring	1
	1-603992	O-Ring	1
2	1-603718	Wheel Motor	2
	1-000138	Kit, Bearing	1
	1-000119	Kit, Seal	1
3	103-2191	Spacer, Hydraulic Tank.....	2
4	32128-33	Nut, Whizlock 1/4-20.....	2
5	1-603990	Adapter, Straight Thread.....	4
	1-603920	O-Ring	1
	1-603992	O-Ring	1
6	103-1799	Elbow, 90°.....	2
	1-603921	O-ring.....	1
7	103-1802	Elbow, 90°.....	2
	1-603921	O-ring.....	1
8	106-5490	Pump, Hydro.....	1
	103-2664	Kit, Input Shaft 10A	1
	94-6922	Kit, Thrust Bearing 10A	1
	103-2666	Kit, Cylinder Block 10A.....	1
	105-6184	Kit, Overhaul Seal	1
9	3290-357	Nut, Whizlock 3/8-16.....	4
10	3256-3	Washer, 5/16 Std	8
11	323-7	Screw, HH 3/8-16 x 1-1/4	4
12	1-613034	Hose, Hydro.....	2
13	1-323241	Hose, Hydro.....	2
14	103-3914	Asm, Charge Hose.....	1

Item	Part No.	Description	Qty.
15	103-4019	Asm, Case Drain Hose	1
16	1-513211	Element, Oil Filter	1
▲	1-523541	Element, Oil Filter(Winter).....	1
17	103-2889	Asm, Filter Head	1
	103-1912	Adapter, Straight.....	2
	1-603921	O-Ring	1
18	321-3	Screw, HH 1/4-20 x 5/8.....	2
19	1-805004	Washer, Lock 1/4 Heavy.....	2
20	103-4611	Pump, Hydro.....	1
	103-2664	Kit, Input Shaft 10A	1
	94-6922	Kit, Thrust Bearing 10A	1
	103-2666	Kit, Cylinder Block 10A	1
	105-6184	Kit, Overhaul Seal	1
21	321-15	Screw, HH 1/4-20 x 2 1/2.....	2
22	103-2959	Hose, Charge	1
23	103-1807	Elbow, 45°	1
	1-603921	O-Ring	1
24	3256-22	Washer, 1/4 SAE	2
25	103-1988	Clamp, Hose 11/16	3
26	103-1716	Clamp, Hose 17/32	3
27	103-1801	Adapter, Straight.....	1
	1-603921	O-Ring	1
28	103-1948	Cap, Hydraulic Reservoir	1
29	103-1949	Gasket, Reservoir Cap.....	1
30	103-1947	Asm, Reservoir W/Decal.....	1

Exmark black touch up spray paint – Gloss black.

▲ Use only for operation below 32°F (0°C).

HYDRAULIC GROUP

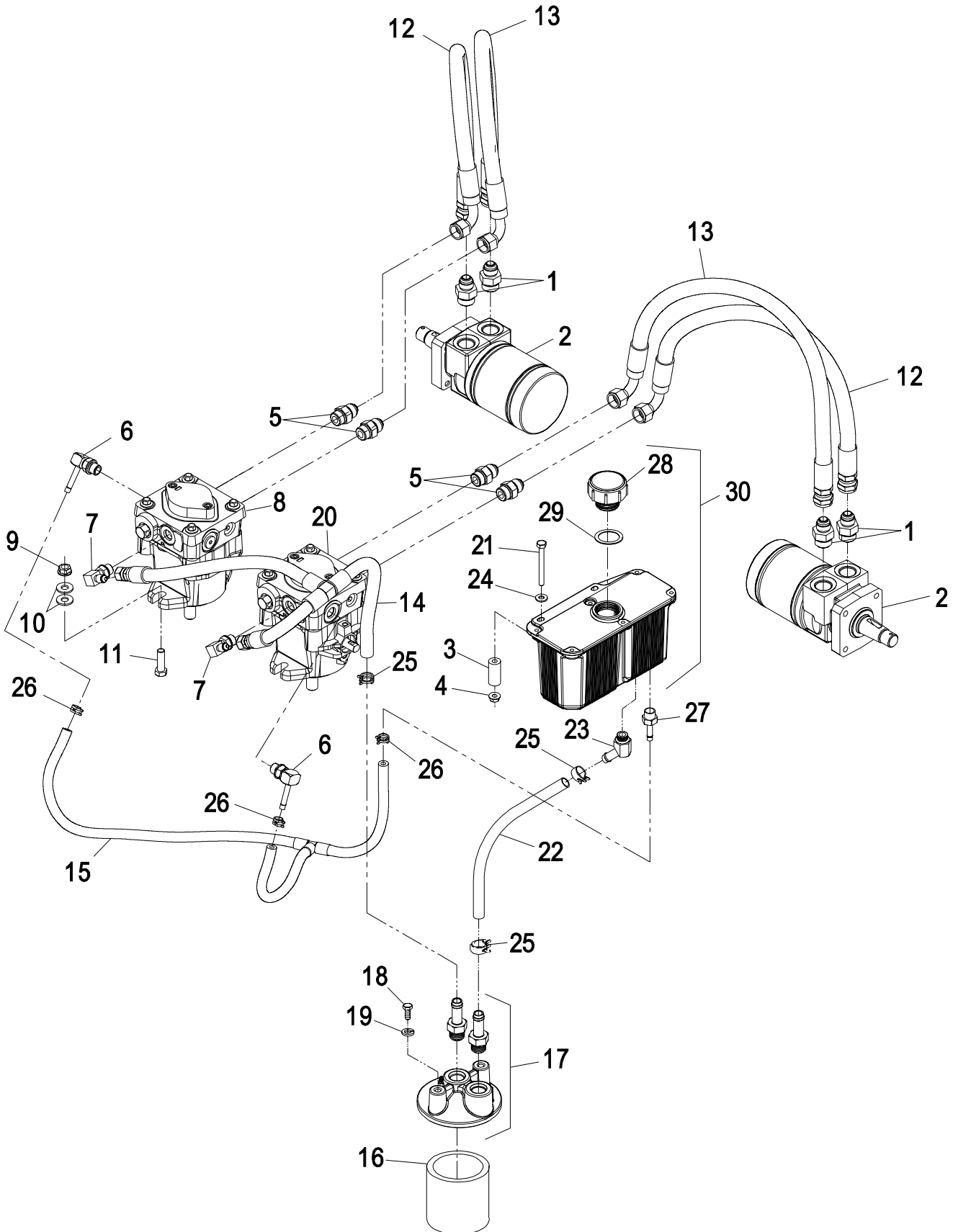

NOTES

SEE EXMARK'S COMPLETE LINE OF ACCESSORIES

RIDING ACCESSORIES

CUSTOM RIDE SEAT SUSPENSION SYSTEM
DECK LIFT ASSIST KIT
HITCH KIT
LIGHT KIT
MICRO-MULCH SYSTEM
ROLL OVER PROTECTION SYSTEM (ROPS)
SNOW BLADE
SUN SHADE
TRASH CONTAINER
TURF STRIPER
ULTRA VAC COLLECTION SYSTEM
ULTRA VAC QUICK DISPOSAL SYSTEM

WALK BEHIND ACCESSORIES

GRASS CATCHER
MICRO-MULCH SYSTEM
STEERABLE SULKY
SULKY HITCH KIT
TURF STRIPER
STANDON

Check us out on the Web:
www.exmark.com

© 1997-2005 EXMARK MFG. CO. INC.
INDUSTRIAL PARK BOX 808
BEATRICE, NE 68310

PART NO. 109-0490 Rev. A
(402) 223-6300
FAX (402) 223-5489

ALL RIGHTS RESERVED

PRINTED IN U.S.A.

