

For Serial Nos.  
540,000 & Higher



OPERATOR'S MANUAL

# TURF TRACER<sup>®</sup> HP

**CONGRATULATIONS** on the purchase of your new Exmark mower. This product has been carefully designed and manufactured to give you a maximum amount of dependability and years of trouble-free operation. If additional information is needed, or should you require trained mechanic service, contact your authorized Exmark equipment dealer or distributor. If you need to order replacement parts from your dealer, always give the model number and serial number of your mower as well as the part number, description and quantity of the part needed.

The Serial No. plate is located next to the fuel tank on the top left hand side of the fuel tank support. For ease of ordering and reference, we suggest that you record the information requested in the following identification table.

Place Model No. and Serial No. Label Here  
(Included in Literature Pack)  
or Fill in Below

Model No. \_\_\_\_\_

Serial No. \_\_\_\_\_

Engine Model No. and Spec. No. (Code) \_\_\_\_\_

Engine Serial No. (E/No) \_\_\_\_\_

Date Purchased \_\_\_\_\_

Part No. 103-9188

|  <b>WARNING</b>   |
|--|
| <b>POTENTIAL HAZARD</b> <ul style="list-style-type: none"><li>◆ This product is a piece of power equipment.</li></ul>  |
| <b>WHAT CAN HAPPEN</b> <ul style="list-style-type: none"><li>◆ Failure to follow safe operating practices can result in serious operator injury or even death.</li></ul>   |
| <b>HOW TO AVOID THE HAZARD</b> <ul style="list-style-type: none"><li>◆ Keep all shields, guards and safety devices (especially the grass discharge system) in place and in proper working condition.</li><li>◆ Stop engine and wait for all moving parts to stop. Remove spark plug wire(s) or remove key before adjusting, servicing, or performing maintenance.</li><li>◆ If mower deck becomes clogged, stop engine and wait for all moving parts to stop. Remove spark plug wire(s) or remove key before cleaning blockage.</li><li>◆ Keep hands, feet, and clothing away from power driven parts.</li><li>◆ Keep off mower unless seat platform is provided.</li><li>◆ Keep others off mower.</li></ul> |

|  <b>WARNING</b>  |
|---|
| <b>POTENTIAL HAZARD</b> <ul style="list-style-type: none"><li>◆ Gasoline is harmful or fatal if swallowed. Long-term exposure to vapors has caused cancer in laboratory animals.</li></ul>  |
| <b>WHAT CAN HAPPEN</b> <ul style="list-style-type: none"><li>◆ Failure to use caution may cause serious injury or illness.</li></ul>  |
| <b>HOW TO AVOID THE HAZARD</b> <ul style="list-style-type: none"><li>◆ Avoid prolonged breathing of vapors.</li><li>◆ Keep face away from nozzle and gas tank/container opening.</li><li>◆ Keep away from eyes and skin.</li><li>◆ Never siphon by mouth.</li></ul> |

**IMPORTANT**

When the mower is used or operated on any California forest, brush or grass covered land, a working spark arrester must be attached to the muffler. If not, the operator is violating state law, Section 4442 Public Resource Code. To acquire a spark arrester for your unit, see your Engine Service Dealer.

This spark ignition system complies with Canadian ICES-002

Ce système d'allumage par étincelle de véhicule est conforme à la norme NMB-002 du Canada

**The enclosed Engine Owner's Manual is supplied for information regarding The U.S. Environmental Protection Agency (EPA) and the California Emission Control Regulation of emission systems, maintenance and warranty.**

**Keep this engine Owner's Manual with your unit. Should this engine Owner's Manual become damaged or illegible, replace immediately. Replacements may be ordered through the engine manufacturer.**

Exmark reserves the right to make changes or add improvements to its products at any time without incurring any obligation to make such changes to products manufactured previously. Exmark, or its distributors and dealers, accept no responsibility for variations which may be evident in the actual specifications of its products and the statements and descriptions contained in this publication.

## EXMARK PARTS PLUS® PROGRAM

EFFECTIVE DATE: September 1, 1995

### Program

If your Exmark dealer does not have the Exmark part in stock, Exmark will get the parts to the dealer the next business day or the part will be FREE\* Guaranteed!!

### *How the Program Works*

1. If dealer does not have part in stock for a "down" unit at the time of request by customer, the dealer contacts his distributor by 1:00 p.m., local time, and requests Exmark Parts Plus® shipment of six (6) line items or less.
2. Distributor ships part(s) to dealer or customer, as requested by dealer, same day, overnight UPS  
Distributor bills dealer for part and freight charges where applicable.
3. If distributor does not have the part(s) in stock to satisfy Exmark Parts Plus® order, he contacts Exmark by 3:00 p.m., central time, with an Exmark Parts Plus® order of six (6) line items or less.
4. If order is received by 3:00 p.m. central time, Exmark ships part(s) direct to dealer or customer, as requested by distributor, same day, overnight UPS, Exmark bills the distributor for parts and shipping charges, where applicable.
5. The customer pays for the part and freight if it is shipped under the Exmark Parts Plus® and if it arrives in accordance to the program.
6. Who pays for the part and freight if it fails to arrive overnight in accordance to the program?
  - A. Under any circumstance the customer does not pay.
  - B. If the part does not arrive overnight due to:
    1. The dealer not submitting the Exmark Parts Plus® order to his Exmark distributor by 1:00 p.m., the dealer pays for the part and freight.
    2. The Distributor being unable to ship the part the same day or not submitting the Exmark Parts Plus® order to Exmark by 3:00 p.m., central time, the Distributor pays for the part and freight.
    3. Exmark being unable to ship the part and the Exmark parts order is received by 3:00 p.m., central time, Exmark pays for the part and freight.
    4. If the part does not arrive overnight due to the shipper (UPS), the shipper pays for the freight and Exmark pays for the part.

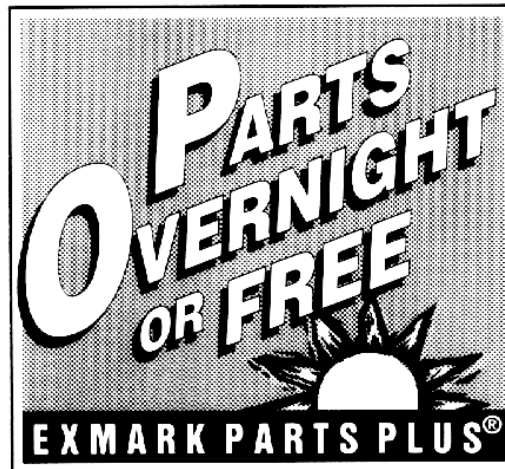

**The following restrictions apply** -- The Exmark Parts Plus® Program is available only through participating Exmark Dealers and applies only to orders submitted on this program Monday through Thursday. Parts Plus service is available only in the 48 contiguous United States. UPS has initiated a Saturday delivery program to many areas of the continental United States and can be requested for an overnight shipment on Friday to be delivered Saturday. The next day air charge, plus the Saturday delivery fee will be the responsibility of the purchaser. Exmark Mfg. will assume no responsibility for Saturday delivery shipments. To qualify, all Exmark Parts Plus® orders must be received by Exmark by 3:00 p.m., central time. Orders must be six (6) line items or less. Exclusions from the Exmark Parts Plus® Program are: Any wholegood or accessory in its entirety, engines and engine replacement parts, 5-speed Peerless transmissions and 5-speed transaxles, hydraulic or hydrostatic wheel motors, cutter decks and engine decks or any item exceeding United Parcel Service size and weight restrictions.

Due to UPS restrictions, aerosol spray paint is considered a hazardous material and cannot be shipped via UPS next day or Second Day Air.

Exmark Manufacturing stocks a limited supply of parts for transaxles, pumps, and wheel motors. These parts can be ordered for Next Day Air shipment but will not be guaranteed per the Parts Plus Program.

**CONGRATULATIONS** on the purchase of your Exmark Mower. This product has been carefully designed and manufactured to give you a maximum amount of dependability and years of trouble-free operation.

## **OPERATOR'S MANUAL**

This manual contains assembly, operating, maintenance, adjustment, and safety instructions for your Exmark mower.

**BEFORE OPERATING YOUR MOWER, CAREFULLY READ THIS MANUAL IN ITS ENTIRETY.**

By following the operating, maintenance and safety instructions, you will prolong the life of your mower, maintain its maximum efficiency, and promote safe operation.

If additional information is needed, or should you require trained mechanic service, contact your authorized Exmark equipment dealer or distributor.

All Exmark equipment dealers and distributors are kept informed of the latest methods of servicing and are equipped to provide prompt and efficient service in the field or at their service stations. They carry ample stock of service parts or can secure them promptly for you from the factory.

All Exmark parts are thoroughly tested and inspected before leaving the factory, however, attention is required on your part if you are to obtain the fullest measure of satisfaction and performance.

## TABLE OF CONTENTS

|   |             |
|---|-------------|
| <b>1. SAFETY</b> .....                  | <b>PAGE</b> |
| 1.1 Safety Alert Symbol.....            | 1           |
| 1.2 Training.....                       | 1           |
| 1.3 Preparation .....                   | 1-3         |
| 1.4 Operation.....                      | 3-6         |
| 1.5 Maintenance & Storage.....          | 6-7         |
| 1.6 Riding Attachments.....             | 7           |
| 1.7 Safety Signs.....                   | 7-10        |
| <b>2. SPECIFICATIONS</b>                |             |
| 2.1 Model Number .....                  | 10          |
| 2.2 Engine.....                         | 10          |
| 2.3 Fuel System .....                   | 10          |
| 2.4 Electrical System .....             | 10          |
| 2.5 Safety Interlock System .....       | 11          |
| 2.6 Steering/Brake Control.....         | 11          |
| 2.7 Transmission.....                   | 11          |
| 2.8 Wheel Drive System .....            | 11          |
| 2.9 Tires.....                          | 11          |
| 2.10 Deck.....                          | 11          |
| 2.11 Dimensions .....                   | 11-12       |
| 2.12 Torque Requirements .....          | 12          |
| <b>3. ASSEMBLY INSTRUCTIONS</b>         |             |
| 3.1 to 3.20 Assembly .....              | 12-16       |
| <b>4. OPERATION INSTRUCTIONS</b>        |             |
| 4.1 Controls .....                      | 16-18       |
| 4.2 Pre-Start .....                     | 18          |
| 4.3 Operation Instructions.....         | 18-21       |
| 4.4 Transporting.....                   | 22          |
| <b>5. MAINTENANCE &amp; ADJUSTMENTS</b> |             |
| 5.1 Periodic Maintenance.....           | 22-30       |
| 5.2 Adjustments .....                   | 31-36       |
| <b>6. WASTE DISPOSAL</b>                |             |
| 6.1 Motor Oil Disposal.....             | 36          |
| 6.2 Battery Disposal.....               | 36          |
| <b>7. TROUBLE SHOOTING</b>              |             |
| 7.1 Mower Tracks Left or Right.....     | 37          |
| 7.2 Mower Cuts Unevenly .....           | 37          |
| 7.3 Engine Will Not Start.....          | 37-38       |
| <b>8. WIRING DIAGRAM</b> .....          | 39          |
| <b>9. HYDRAULIC DIAGRAM</b> .....       | 40          |
| <b>10. WARRANTY</b> .....               | 41          |

## 1. SAFETY

### 1.1 SAFETY ALERT SYMBOL

This SAFETY ALERT SYMBOL  is used both in this manual and on the machine to identify important safety messages which must be followed to avoid accidents. This symbol means:

#### **ATTENTION! BECOME ALERT! YOUR SAFETY IS INVOLVED!**

The safety alert symbol appears above information which alerts you to unsafe actions or situations and will be followed by the word **DANGER**, **WARNING**, or **CAUTION**.

**DANGER:** White lettering/Red background. Indicates an imminently hazardous situation which, if not avoided, **WILL** result in death or serious injury.

**WARNING:** Black lettering/Orange background. Indicates a potentially hazardous situation which, if not avoided, **COULD** result in death or serious injury.

**CAUTION:** Black lettering/Yellow background. Indicates a potentially hazardous situation which, if not avoided, **MAY** result in minor or moderate injury.

### 1.2 TRAINING

- 1.2.1 Regard the Exmark mower as a piece of power equipment and teach this regard to all who operate this unit.
- 1.2.2 Read the instructions carefully. Familiarize yourself with the controls and the proper use of the equipment. If the operator(s) or mechanic(s) can not read English, it is the owner's responsibility to explain this material to them.
- 1.2.3 Do not allow operation of this machine by untrained personnel. Never allow children, teenagers, or people unfamiliar with these instructions to use the mower. Local regulations may restrict the age of the operator.
- 1.2.4 Avoid mowing while people, especially children, or pets, are nearby. Keep in mind that the operator or user is responsible for accidents or hazards occurring to other people or their property.

### 1.3 PREPARATION

- 1.3.1 Evaluate the terrain to determine what accessories and attachments are needed to properly and safely perform the job. Only use accessories and attachments approved by Exmark.
- 1.3.2 The use of personal protective equipment, such as (but not limited to) protection for the eyes, ears, feet, and head is recommended.

|  <b>CAUTION</b> |  |
|--|--|
| <b>POTENTIAL HAZARD</b>  | ◆ This machine produces sound levels in excess of 85 dBA at the operator's ear when in operation.  |
| <b>WHAT CAN HAPPEN</b>   | ◆ Exposure to sound levels of 85 dBA or above for extended periods of time can cause hearing loss. |
| <b>HOW TO AVOID THE HAZARD</b>   | ◆ Wear hearing protection when operating this machine.   |

- 1.3.3 While mowing, always wear substantial footwear and long trousers. Do not operate equipment when barefoot or when wearing open sandals.

- 1.3.4 Thoroughly inspect the area where the equipment is to be used and remove all stones, sticks, wires, bones and other foreign objects which may damage the equipment or cause personal injury to the operator or bystanders.

|  <b>WARNING</b>  |
|---|
| <b>POTENTIAL HAZARD</b> <ul style="list-style-type: none"><li>◆ Engine exhaust contains carbon monoxide, which is an odorless deadly poison.</li></ul>                                    |
| <b>WHAT CAN HAPPEN</b> <ul style="list-style-type: none"><li>◆ Carbon monoxide can kill you.</li></ul>  |
| <b>HOW TO AVOID THE HAZARD</b> <ul style="list-style-type: none"><li>◆ Do not run engine indoors or in a small confined area where dangerous carbon monoxide fumes can collect.</li></ul> |

|  <b>DANGER</b>  |
|--|
| <b>POTENTIAL HAZARD</b> <ul style="list-style-type: none"><li>◆ In certain conditions gasoline is extremely flammable and highly explosive.</li></ul>  |
| <b>WHAT CAN HAPPEN</b> <ul style="list-style-type: none"><li>◆ A fire or explosion from gasoline can burn you, others, and cause property damage.</li></ul>  |
| <b>HOW TO AVOID THE HAZARD</b> <ul style="list-style-type: none"><li>◆ <i>DO NOT</i> smoke while refueling, and stay away from an open flame or where gasoline fumes may be ignited by spark.</li><li>◆ Refuel only outdoors.</li><li>◆ Store gasoline in an approved container and keep it out of the reach of children.</li><li>◆ Add fuel before starting the engine. <i>Never</i> remove the cap of the fuel tank or add fuel when engine is running or when the engine is hot.</li><li>◆ Never fill the fuel tank so that the gasoline level rises above a level that is 1/2" (1.3 cm) below the bottom of the filler neck to allow for gasoline expansion and prevent fuel spillage.</li><li>◆ If fuel is spilled, <i>DO NOT</i> attempt to start the engine. Move away from the area of the spill and avoid creating any source of ignition until fuel vapors have dissipated.</li><li>◆ Do not operate without entire exhaust system in place and in proper working condition.</li></ul> |

|  <b>DANGER</b>  |
|--|
| <b>POTENTIAL HAZARD</b> <ul style="list-style-type: none"><li>◆ In certain conditions gasoline is extremely flammable and highly explosive.</li></ul>  |
| <b>WHAT CAN HAPPEN</b> <ul style="list-style-type: none"><li>◆ A static charge can ignite gasoline vapors. A fire or explosion from gasoline can burn you, others, and cause property damage.</li></ul>  |
| <b>HOW TO AVOID THE HAZARD</b> <ul style="list-style-type: none"><li>◆ Purchase and store gasoline only in an approved container.</li><li>◆ Always place gasoline containers on the ground away from your vehicle before filling.</li><li>◆ Do not fill gasoline containers inside a vehicle or on a truck or trailer bed because interior carpets or plastic truck bed liners may insulate the container and slow the loss of any static charge.</li><li>◆ When practical, remove gas-powered equipment from the truck or trailer and refuel the equipment with its wheels on the ground.</li><li>◆ If this is not possible, then refuel such equipment on a truck or trailer from a portable container, rather than from a gasoline dispenser nozzle.</li><li>◆ If a gasoline dispenser nozzle must be used, keep the nozzle in contact with the rim of the fuel tank or container opening at all times until fueling is complete.</li></ul> |

|  <b>WARNING</b>   |
|--|
| <b>POTENTIAL HAZARD</b> <ul style="list-style-type: none"><li>◆ Gasoline vapor can collect inside enclosed trailers and may be ignited by electrical sparks or hot engine/exhaust components.</li></ul>  |
| <b>WHAT CAN HAPPEN</b> <ul style="list-style-type: none"><li>◆ Explosion and fire may occur, resulting in property damage, personal injury, and/or death.</li></ul>  |
| <b>HOW TO AVOID THE HAZARD</b> <ul style="list-style-type: none"><li>◆ Provide adequate ventilation of any enclosed trailer to prevent build up of gasoline vapors, especially at floor level.</li><li>◆ Refuel only outdoors, never inside an enclosed trailer.</li><li>◆ Be sure all fuel tanks and gasoline storage containers have proper caps installed to prevent spillage and minimize vapor escaping into the trailer.</li><li>◆ Do not place any equipment that is leaking gasoline in an enclosed trailer.</li></ul> |

#### 1.4 OPERATION

***Although hazard control and accident prevention are partially dependent upon the design and configuration of the equipment, these factors are also dependent upon the awareness, concern, prudence and proper training of the personnel involved in the operation, transport, maintenance and storage of the equipment. It is essential that all Operator Safety Mechanisms be connected and in operating condition prior to use for mowing.***



|  <b>WARNING</b>  |
|---|
| <b>POTENTIAL HAZARD</b> <ul style="list-style-type: none"><li>◆ Operating engine parts, especially the muffler, become extremely hot.</li></ul>   |
| <b>WHAT CAN HAPPEN</b> <ul style="list-style-type: none"><li>◆ Severe burns can occur on contact.</li><li>◆ Debris, such as leaves, grass, brush, etc. can catch fire.</li></ul>  |
| <b>HOW TO AVOID THE HAZARD</b> <ul style="list-style-type: none"><li>◆ Allow engine parts, especially the muffler, to cool before touching.</li><li>◆ Remove accumulated debris from muffler and engine area.</li><li>◆ Install and maintain in working order a spark arrester before using equipment on forest-covered, grass-covered, or brush-covered unimproved land.</li></ul> |

|  <b>WARNING</b>   |
|--|
| <b>POTENTIAL HAZARD</b> <ul style="list-style-type: none"><li>◆ Hands, feet, hair, clothing, or accessories can become entangled in rotating parts.</li></ul>  |
| <b>WHAT CAN HAPPEN</b> <ul style="list-style-type: none"><li>◆ Contact with rotating parts can cause traumatic amputation or severe lacerations.</li></ul>   |
| <b>HOW TO AVOID THE HAZARD</b> <ul style="list-style-type: none"><li>◆ Do not operate the machine without guards, shields, and safety devices in place and working.</li><li>◆ Keep hands, feet, hair, jewelry, or clothing away from rotating parts.</li></ul> |

- 1.4.1 Give complete, undivided attention to the job at hand.
- 1.4.2 Mow only in daylight or good artificial light, keeping away from holes and hidden hazards. **Do Not** operate the mower when children or others are in the area!
- 1.4.3 When feasible, avoid operating the equipment in wet grass.
- 1.4.4 Use **EXTREME** caution when mowing and/or turning on slopes as loss of traction and/or control could occur.

|  <b>DANGER</b>  |
|--|
| <b>POTENTIAL HAZARD</b> <ul style="list-style-type: none"><li>◆ Mowing on wet grass or steep slopes can cause sliding and loss of control.</li></ul>   |
| <b>WHAT CAN HAPPEN</b> <ul style="list-style-type: none"><li>◆ Loss of control and/or loss of operator's footing could result in a fall with an arm or leg getting under the mower or engine deck, which may result in serious injury or death.</li></ul>  |
| <b>HOW TO AVOID THE HAZARD</b> <ul style="list-style-type: none"><li>◆ Mow across slopes, never up and down.</li><li>◆ Do not mow slopes when grass is wet.</li><li>◆ Do not mow near drop-offs or near water.</li><li>◆ Do not mow slopes greater than 20 degrees.</li><li>◆ Reduce speed and use extreme caution on slopes.</li><li>◆ Avoid sudden turns or rapid speed changes.</li></ul> |

- See inside the back cover to determine the approximate slope angle of the area to be mowed.
  - Progressively greater care is needed as the slope increases.
  - Always avoid sudden starting or stopping on a slope. If tires lose traction, disengage the blades and proceed slowly off the slope.
  - Be aware that loss of traction may occur going downhill. Weight transfer to the front wheels may cause drive wheels to slip and cause loss of braking and steering.
  - Watch for ditches, holes, rocks, dips, and rises that change the operating angle, as rough terrain could overturn the machine.
  - Remove or mark obstacles such as rocks, tree limbs, etc. from the mowing area. Tall grass can hide obstacles.
  - Use extreme care with grass catchers or attachments. These can change the stability of the machine and cause loss of control.
- 1.4.5 Use **EXTREME** caution when backing up. **LOOK BEHIND YOU!!**
- 1.4.6 Stop the blades when crossing surfaces other than grass, if mower must be tilted for transportation, and when transporting the mower to and from the area to be mowed.
- 1.4.7 Never operate the mower with defective guards, shields, or covers. Always have safety shields, guards, switches, and other devices in place and in proper working condition.
- 1.4.8 **Do Not** change the engine governor settings or over-speed the engine. Operating an engine at excessive speed may increase the hazard of personal injury.
- 1.4.9 Place speed control levers in neutral lock position, disengage PTO, and engage park brake before starting engine.
- 1.4.10 Start the engine carefully with feet well away from blades.
- 1.4.11 Keep hands, feet, and clothing away from rotating parts while the mower is being operated.
- 1.4.12 Stop the engine and wait for all moving parts to stop. Remove plug wire(s) or ignition key:
- Before checking, cleaning, or working on the mower.
  - After striking a foreign object (inspect the mower for damage and make repairs before restarting and operating the mower).
  - Before clearing blockages.
  - Whenever you leave the mower.
- 1.4.13 Stop the engine and wait for all moving parts to stop:
- Before removing the grass catcher.
  - Before refueling.
  - Before making height adjustments.
- 1.4.14 Before stopping the engine, place the throttle control **midway** between the “slow” and “fast” positions. Allow the engine to run a minimum of 15 seconds; then stop the engine.
- 1.4.15 The fuel system is provided with a shut-off valve. The fuel shut-off valve is used to shut off the fuel when:
- The machine will not be used for a few days.
  - During transport to and from the job.
  - When parking inside a building.

- 1.4.16 This mower was designed for one operator only. Keep all others away from mower during operation.
- 1.4.17 **Do Not** mow with the grass deflector raised, removed, or altered unless there is a grass collection system or a mulch kit in place and working properly.
- 1.4.18 Be aware of the mower discharge direction and direct discharge away from others.
- 1.4.19 **Do Not** operate the mower under the influence of alcohol or drugs.
- 1.4.20 Use care when approaching blind corners, shrubs, trees, or other objects that may obscure vision.
- 1.4.21 If jump starting is required: (Electric start units only)
  - a) connect the positive (+) power cable from the positive post on the booster battery to the positive terminal post on the starter solenoid switch (this post has the positive battery cable attached to it).
  - b) connect the negative or ground cable (-) from the negative post on the booster battery to the engine block as far away from the battery as possible.
  - c) disconnect battery cables in the reverse order after starting.

## 1.5 MAINTENANCE AND STORAGE

- 1.5.1 For engine maintenance, follow the engine manufacture's recommendations precisely as stated in the engine manual.
- 1.5.2 Disconnect the battery from the negative battery post when the unit will be allowed to sit for more than 30 days without use.
- 1.5.3 Allowing batteries to stand for an extended period of time without recharging them will result in reduced performance and service life. To preserve optimum battery performance and life, recharge batteries in storage when the open circuit voltage drops to 12.4 volts.

Note: To prevent damage due to freezing, battery should be fully charged before putting away for winter storage.
- 1.5.4 Keep engine and engine area free from accumulation of grass, leaves, excessive grease, or oil and other debris, which can accumulate in these areas. These materials can become combustible and may result in a fire.
- 1.5.5 Store fuel in a container specifically designed for this purpose in a cool, dry place.
- 1.5.6 Keep the mower and fuel container in locked storage to prevent children from playing or tampering with them.
- 1.5.7 Gasoline powered equipment or fuel containers should not be stored in a basement or any enclosed area, where open pilot lights or heat appliances are present.
- 1.5.8 Maximum mowing results and safety can only be achieved if the mower is properly maintained and operated correctly.
- 1.5.9 Check all bolts frequently to maintain proper tightness.
- 1.5.10 Keep all guards, shields, and all safety devices in place and in safe working condition.
- 1.5.11 Frequently check for worn or deteriorating components that could create a hazard.
- 1.5.12 All replacement parts must be the same as or equivalent to the parts supplied as original equipment.

|  <b>WARNING</b>  |
|---|
| <b>POTENTIAL HAZARD</b> <ul style="list-style-type: none"><li>◆ Hydraulic fluid escaping under pressure can penetrate skin and cause injury.</li></ul>  |
| <b>WHAT CAN HAPPEN</b> <ul style="list-style-type: none"><li>◆ Fluid accidentally injected into the skin must be surgically removed within a few hours by a doctor familiar with this form of injury or gangrene may result.</li></ul>  |
| <b>HOW TO AVOID THE HAZARD</b> <ul style="list-style-type: none"><li>◆ Make sure all hydraulic fluid hoses and lines are in good condition and all hydraulic connections and fittings are tight before applying pressure to hydraulic system.</li><li>◆ Keep body and hands away from pinhole leaks or nozzles that eject high pressure hydraulic fluid.</li><li>◆ Use cardboard or paper and not hands to find hydraulic leaks.</li><li>◆ Safely relieve all pressure in the hydraulic system, by locking drive levers in neutral and shutting off engine, before performing any work on the hydraulic system.</li></ul> |

## 1.6 RIDING ATTACHMENTS

- 1.6.1 Use only Exmark riding attachments. The use of other than Exmark riding attachments may create a hazardous condition resulting in injury.

## 1.7 SAFETY SIGNS

- 1.7.1 Keep all safety signs legible. Remove all grease, dirt, and debris from safety signs and instructional labels.
- 1.7.2 Safety signs must be replaced if they are missing or illegible.
- 1.7.3 When new components are installed, be sure that current safety signs are affixed to the replaced components.
- 1.7.4 New safety signs may be obtained from your authorized Exmark equipment dealer or distributor or from Exmark Mfg. Co. Inc.
- 1.7.5 Safety signs may be affixed by peeling off the backing to expose the adhesive surface. Apply only to a clean, dry surface. Smooth to remove any air bubbles.
- 1.7.6 Familiarize yourself with the following safety signs and instruction labels. They are critical to the safe operation of your Exmark commercial mower.

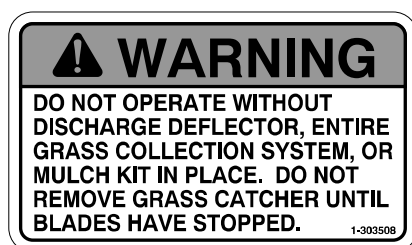

PART NO. 1-303508  
LOCATION: Right Front of Mower  
Deck Top Surface

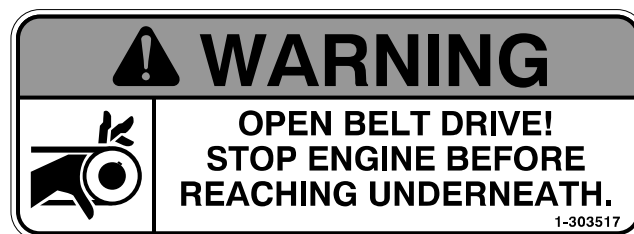

PART NO. 1-303517  
LOCATION: Left Side of Rear  
Surface of Engine Deck



PART NO. 1-403005  
 LOCATION: RH & LH Corners  
 of Mower Deck

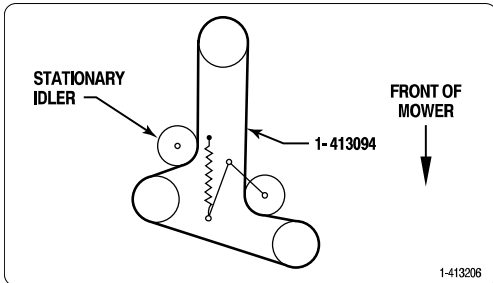

36" Decks  
 PART NO. 1-413206  
 LOCATION: Top of Cutter Deck  
 Under Center Belt Shield

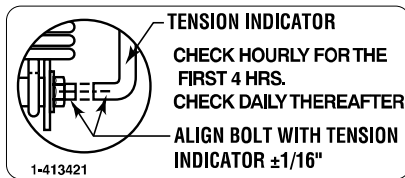

PART NO. 1-413421  
 LOCATION: Left Rear on Top of Engine Deck



19 HP Kawasaki Electric Start Only  
 PART NO. 1-513747  
 LOCATION: Battery Cover

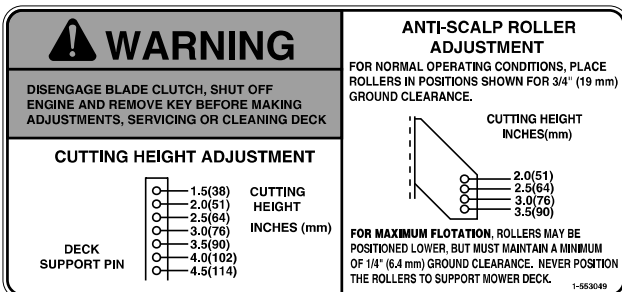

PART NO. 1-553049  
 LOCATION: Front of Mower  
 Deck Top Surface



PART NO. 1-403143  
 LOCATION: Right Side of Rear  
 Surface of Engine Deck



PART NO. 1-413214  
 LOCATION: Right Side of Hydro Control Crank Arm

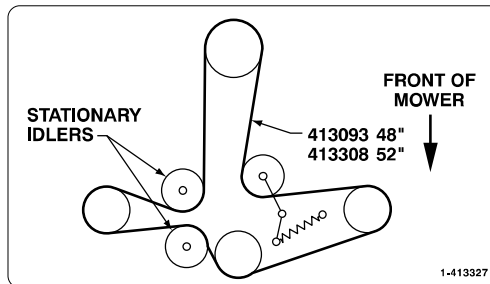

48" & 52" Decks  
 PART NO. 1-413327  
 LOCATION: Top Center of Cutter Deck  
 Under Center Belt Shield



PART NO. 1-513746  
 LOCATION: On Engine Blower  
 Housing Next to  
 Muffler and On  
 Center Belt Cover



PART NO. 1-523552  
 LOCATION: On Top of  
 Hydraulic Tank

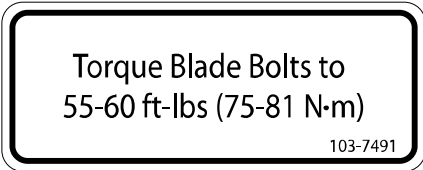

PART NO. 103-7491  
LOCATION: On Top LH Side of Mower Deck.



PART NO. 98-5954  
LOCATION: Under Mower Deck  
Belt Shield(s)



PART NO. 103-1798  
LOCATION: RH Side Console



PART NO. 103-2103  
LOCATION: Park Brake Lever



19 HP Kawasaki Electric Start  
PART NO. 103-1976  
LOCATION: Console

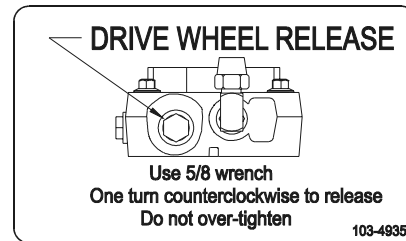

PART NO. 103-4935  
LOCATION: Rear Center of Top Surface of Engine Deck

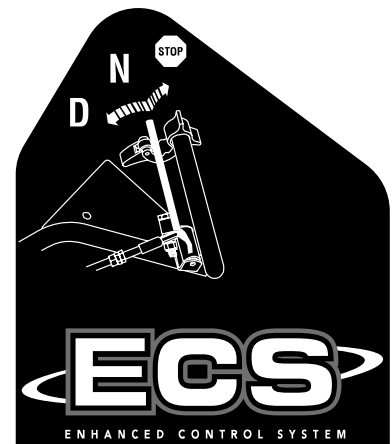

PART NO. 103-2242  
LOCATION: LH Side of Console

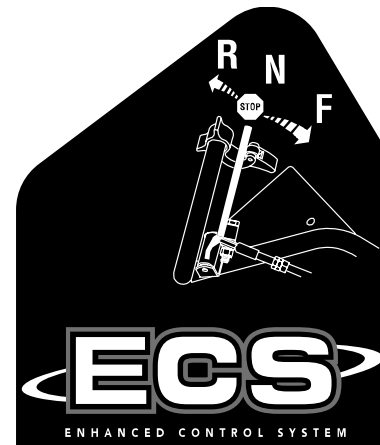

PART NO. 103-2243  
LOCATION: RH Side of Console

15 & 17 HP Kawasaki Manual Start  
PART NO. 103-1977  
LOCATION: Console

## SPECIFICATIONS

**2.1 MODEL NUMBER:** TT3615KAC; TT4817KAC; TT4819KAC; TT4819KAEC;  
TT5219KAC; TT5219KAEC

### 2.2 ENGINE

- 2.2.1 Engine Specifications: See your Engine Owner's Manual.
- 2.2.2 3600 RPM (No Load).

### 2.3 FUEL SYSTEM

- 2.3.1 Capacity: 5.0 gal.(18.9 L.)
- 2.3.2 Type of Fuel: Regular **unleaded** gasoline, 87 octane or higher. In countries using the research method, it should be a 90 octane *minimum*.
- 2.3.3 Fuel Filter: Replaceable in-line
- 2.3.4 Fuel Shut-Off Valve: 1/4 turn

### 2.4 ELECTRICAL SYSTEM

- 2.4.1 Charging System: Flywheel Alternator
- 2.4.2 Charging Capacity: 15 amps
- 2.4.3 Battery Type: BCI Group U1
- 2.4.4 Battery Voltage: 12 Volt; Polarity, negative ground
- 2.4.5 Fuses: Two 20 amp blade type

## 2.5 SAFETY INTERLOCK SYSTEM

Operator must have speed control lever in neutral, PTO disengaged, (and OPC levers depressed for electric start) to start engine. Release of OPC levers will cause the engine to stop if *speed control lever is **not** in neutral and/or PTO is **engaged**.*

## 2.6 STEERING CONTROL

Fingertip drive control levers provide independent speed control, braking, and neutral to each drive wheel for moving forward or reverse, stopping, and power turning.

## 2.7 TRANSMISSION:

Twin Hydrostatic Drive

2.7.1 Two Hydro Gear BDP-10A series variable displacement high efficiency pumps independently coupled to two high efficiency Parker/Ross wheel drive motors.

2.7.2 Hydraulic Filter is replaceable cartridge type.

P/N 1-513211: 10 microns, 18 psi bypass (Summer use above 32° F (0°C))

P/N 1-523541: 40 microns, 18 psi bypass (Winter use below 32° F (0°C))

2.7.3 Speed Range:            Forward    0 - 6.2 mph (10.0 km/h)  
    Reverse    0 - 2.2 mph (3.5 km/h)

## 2.8 WHEEL DRIVE SYSTEM

Drive wheels are direct coupled to Parker/Ross wheel drive motors with 1.0" (25.4 mm) tapered shaft.

| 2.9 TIRES  | 36" Drive              | 48" & 52" Drive        | Front Caster   |
|------------|------------------------|------------------------|----------------|
|            | Pneumatic (Air-Filled) | Pneumatic (Air-Filled) | Semi-Pneumatic |
| Size       | 16 x 6.50-8            | 16 x 7.50-8            | 9 x 3.50-4     |
| Quantity   | 2                      | 2                      | 2              |
| Tread      | Turf Master            | Turf Master            | Smooth         |
| Ply Rating | 4                      | 4                      |                |
| Pressure   | 14 psi (97 kPa)        | 14 psi (97 kPa)        |                |

## 2.10 DECK

2.10.1 Cutting Width:

Model 36 in. .... 35.25 in. (89.5 cm)

Model 48 in. .... 47.25 in. (120.0 cm)

Model 52 in. .... 52.00 in. (132.1 cm)

2.10.2 Discharge: Right Side

2.10.3 Blade Size:

Model 36 in. .... 18.00 in. (45.7 cm) ..... Qty. 2

Model 48 in. .... 16.25 in. (41.3 cm) ..... Qty. 3

Model 52 in. .... 18.00 in. (45.7 cm) ..... Qty. 3

2.10.4 Type of Drive: Manual engagement of belt with over-center lock. Belt tension is adjustable via turnbuckle.

2.10.5 Deck Mounting: Full floating deck is attached to out-front support frame, removable for service.

2.10.6 Cutting Height: Adjusts in 1/2" (1.3 cm) increments from 1.5" (3.8 cm) to 4 1/2" (11.4 cm).

## 2.11 DIMENSIONS

2.11.1 Overall Width:

|  | 36"                  | 48"                  | 52"                  |
|--|----------------------|----------------------|----------------------|
| <b>Discharge chute down</b>                    | 46.25"<br>(117.5 cm) | 58.25"<br>(148.0 cm) | 62.6"<br>(159.0 cm)  |
| <b>Discharge chute up<br/>(Transport only)</b> | 36.1"<br>(91.7 cm)   | 48.1"<br>(122.2 cm)  | 53.0"<br>(134.62 cm) |



|        |                 |                      |                     |                      |
|--------|-----------------|----------------------|---------------------|----------------------|
| 2.11.2 | Overall Length: | <b>36"</b>           | <b>48"</b>          | <b>52"</b>           |
|        |                 | 77.7"<br>(196 cm)    | 73.7"<br>(185 cm)   | 75.9"<br>(191 cm)    |
| 2.11.3 | Curb Weight:    | <b>36"</b>           | <b>48"</b>          | <b>52"</b>           |
|        |                 | 565 lbs.<br>(211 kg) | 610 lbs.<br>(277kg) | 644 lbs.<br>(292 kg) |

\* Weights will vary slightly depending on engine and electric start options.

2.11.4 Overall Height: 44.1" (112 cm) (all models)

2.11.5 Tread Width (to outside of tires):

- 36" Model ..... 35.0" (88.9 cm)
- 48" Model ..... 39.4" (100.1 cm)
- 52" Model ..... 39.4" (100.1 cm)

## 2.12 TORQUE REQUIREMENTS

| <u>BOLT LOCATION</u>                      | <u>TORQUE</u>                 |
|---|-------------------------------|
| Blade Mounting Bolt .....                 | 55-60 ft-lbs. (75-81 N-m)     |
| Cutter Housing Spindle Nut .....          | 140-145 ft-lbs. (190-197 N-m) |
| Anti-Scalp Roller Bolts.....              | 40-45 ft-lbs. (54-61 N-m)     |
| Mower Deck Support/Engine Deck Mount..... | 30-35 ft-lbs. (41-47 N-m)     |
| Engine Mounting Bolts .....               | 15-20 ft-lbs. (20-27 N-m)     |
| Wheel Lug Nuts .....                      | 90-95 ft-lbs. (122-129 N-m)   |
| Wheel Hub Slotted Nut.....                | minimum 100 ft-lbs. (136 N-m) |

## 3. ASSEMBLY INSTRUCTIONS

3.1 Uncrate Unit: Remove upper handle assembly, fuel tank, and linkages from the top of the crate.

3.2 Service Battery:

**WARNING:** Battery posts, terminals, and related accessories contain lead compounds, chemicals known to the State of California to cause cancer and reproductive harm. **Wash hands after handling.**

***The machine is shipped with a filled lead acid battery.***

3.2.1 Remove battery cover from the machine.

|   |
|---|
|  <b style="font-size: 1.2em; margin-left: 10px;">DANGER</b>  |
| <b>POTENTIAL HAZARD</b><br>♦ Charging the battery may produce explosive gasses  |
| <b>WHAT CAN HAPPEN</b><br>♦ Battery gasses can explode causing serious injury.  |
| <b>HOW TO AVOID THE HAZARD</b><br>♦ Keep sparks, flames, or cigarettes away from battery.<br>♦ Ventilate when charging or using battery in an enclosed space.<br>♦ Make sure venting path of battery is always open once battery is filled with acid. |

3.2.2 Check the voltage of the battery with a digital voltmeter. Locate the voltage reading of the battery in the table below and charge the battery for the recommended time interval to bring the charge up to a full charge of 12.6 volts or greater.

**IMPORTANT:** Make sure the negative battery cables are disconnected and the battery charger used for charging the battery has an output of 16 volts and 7 amps or less to avoid damaging the battery (see chart below for recommended charger settings).

| Voltage Reading | Percent Charge | Maximum Charger Settings | Charging Interval    |
|-----------------|----------------|--------------------------|----------------------|
| 12.6 or greater | 100%           | 16 volts/7 amps          | No Charging Required |
| 12.4 – 12.6     | 75 – 100%      | 16 volts/7 amps          | 30 Minutes           |
| 12.2 – 12.4     | 50 – 75%       | 16 volts/7 amps          | 1 Hour               |
| 12.0 – 12.2     | 25 – 50%       | 14.4 volts/4 amps        | 2 Hours              |
| 11.7 – 12.0     | 0 – 25%        | 14.4 volts/4 amps        | 3 Hours              |
| 11.7 or less    | 0%             | 14.4 volts/2 amps        | 6 Hours or More      |

**CAUTION**

|  |
|--|
| <b>POTENTIAL HAZARD</b><br>♦ If the ignition is in the “ON” position there is potential for sparks and engagement of components. |
| <b>WHAT CAN HAPPEN</b><br>♦ Sparks could cause an explosion or moving parts could accidentally engage causing personal injury.   |
| <b>HOW TO AVOID THE HAZARD</b><br>♦ Be sure ignition switch is in the “OFF” position before charging the battery.                |

3.2.3 Connect the negative battery cables.

**NOTE:** If the positive cable is also disconnected, connect the **positive (red) cable** to the positive terminal on the battery **first**, then connect the negative (black) cable to the negative terminal on the battery. Reinstall battery cover.

**NOTE:** If time does not permit charging the battery, or if charging equipment is not available, connect the negative battery cables and run the vehicle continuously for 20 to 30 minutes to sufficiently charge the battery.

|  |
|--|
| <b>WARNING</b>   |
| BATTERY CONTAINS SULFURIC ACID, AVOID CONTACT AND ALWAYS SHIELD EYES, FACE, SKIN AND CLOTHING FROM BATTERY. CIGARETTES, FLAMES OR SPARKS COULD CAUSE BATTERY TO EXPLODE. DO NOT CHARGE |
| OR USE BOOSTER CABLES OR ADJUST POST CONNECTIONS WITHOUT PROPER TRAINING. IN EVENT OF AN ACCIDENT FLUSH WITH WATER AND CALL A PHYSICIAN IMMEDIATELY. KEEP OUT OF REACH OF CHILDREN.    |

- 3.3 Remove and open the bolt bag.
- 3.4 Loosen the 5/16" hardware at the two (2) discharge chute hinge points so that the deflector is snug, but can be moved up and down freely.
- 3.5 Refer to Parts Manual to help you identify and locate parts and their proper position.
- 3.6 Apply retaining adhesive “Fel-Pro ProLock Retaining I or Retaining II” or “Loctite RC 609 or 680” on the two threaded studs from the bolt bag and install into the two left holes underneath fuel tank. Install the fuel tank on top of the fuel tank support with the studs going through the slots in the support. Install two 5/16 x 3/4 screws with a 5/16 SAE flat washer and 5/16 lock washer into the threaded holes in the right side of the fuel tank. **Do not over tighten.** Place a 5/16 SAE flat washer, then a spring, over each of the studs and fasten with a 5/16 nyloc nut. Tighten 5/16 nyloc nut fully then back off a 1/2 turn. This is to allow for normal fuel tank expansion and contraction with changes in temperature and fuel levels. **Do not over tighten.**
- 3.7 Attach the fuel tank hose to the tank fitting and secure with the clamp provided.
- 3.8 Position the lower end of the handle assembly on the outside of the upper rear section of the fuel tank and handle support. Install four 3/8-16 x 1" bolts (with four spring disk washers against the head of each bolt) from the outside in. Secure using four 3/8" whizlock nuts on the inside of each handle support and tighten until the spring disk washers are flat (See Figure 1).

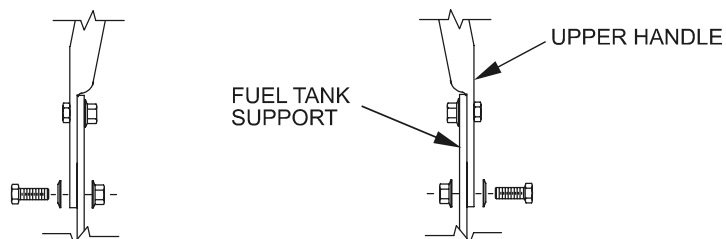

G0001

**FIGURE 1**  
**UPPER HANDLE MOUNTING**

3.9 Route the throttle cable along the right side of the upper handle, under the fuel tank support, and position the cable on the **left** side of the engine.

Attach throttle cable to engine:

- Position the throttle control lever (located on console)  $\frac{1}{4}$ " (6mm) from the upper end of the slot.
- Attach inner wire of the throttle cable to the top hole in the throttle control lever (See Figure 2).
- Loosen the clamp, place the cable behind it, and pull on the cable to move the throttle linkage to the full throttle position. Tighten the cable clamp screw.

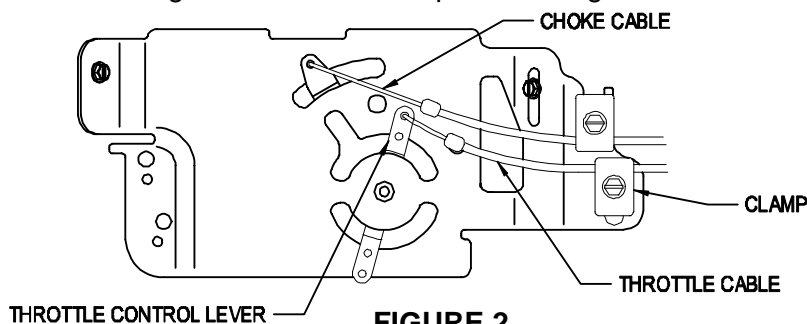

G0002

**FIGURE 2**  
**SPEED CONTROL**  
**(THROTTLE CABLE HOOK-UP)**

3.10 Connect the PTO engagement linkage (See Figure 3). Loosen jam nut and remove turnbuckle from lower linkage. Screw turnbuckle onto both upper and lower linkages simultaneously. Note that threads on upper linkage are left hand. See 5.2.2 for linkage adjustment.

**Note: Handles have the drive lever linkage on the inside of the blade engagement lever tab and the hairpin on the outside.**

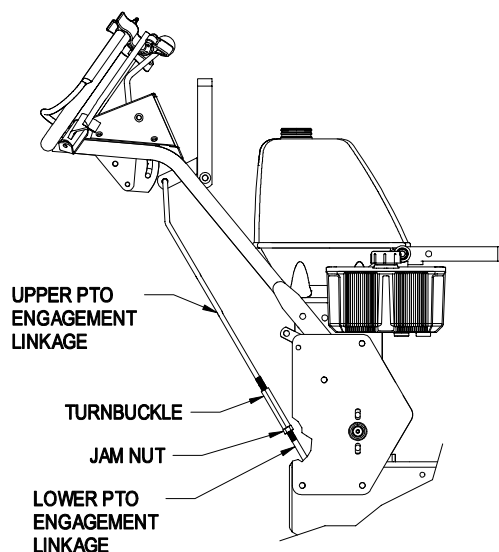

G0003

**FIGURE 3**  
**PTO ENGAGEMENT LINKAGE**

- 3.11 Install the speed control rod assembly (linkage with the yoke installed on one end) into the end of the speed control lever located underneath the center of the console. Insert the end of the linkage (opposite the yoke) into the end of the speed control lever from the right hand side and fasten with a hairpin from the bolt bag.
- 3.12 Connect the lower end of the speed control linkage to the speed control crank located at the top rear of the fuel tank support. Secure with clevis pin and hairpin from the bolt bag.
- 3.13 Install drive lever linkages (See Figure 4). Position the speed control lever in neutral. Position the drive levers in neutral and engage the neutral lock latches (See Figure 6 (b)). Drive lever linkages are shipped with upper ball joints installed. Thread a 3/8-24 LH jam nut, from the bolt bag, onto the lower end of each drive lever linkage. Identify the lower ball joints installed on hydro control arm weldments. Thread lower end of each drive lever linkage into the lower ball joint until hole in upper ball joint aligns with hole in drive lever.

Install 5/16-18 x 1 3/4 hex cap screws and 5/16-18 nyloc nuts from the bolt bag and tighten.

This will give an approximate setting for drive lever linkages; you will need to refer to Section 5.2.6 step d to complete the drive lever linkage adjustment.

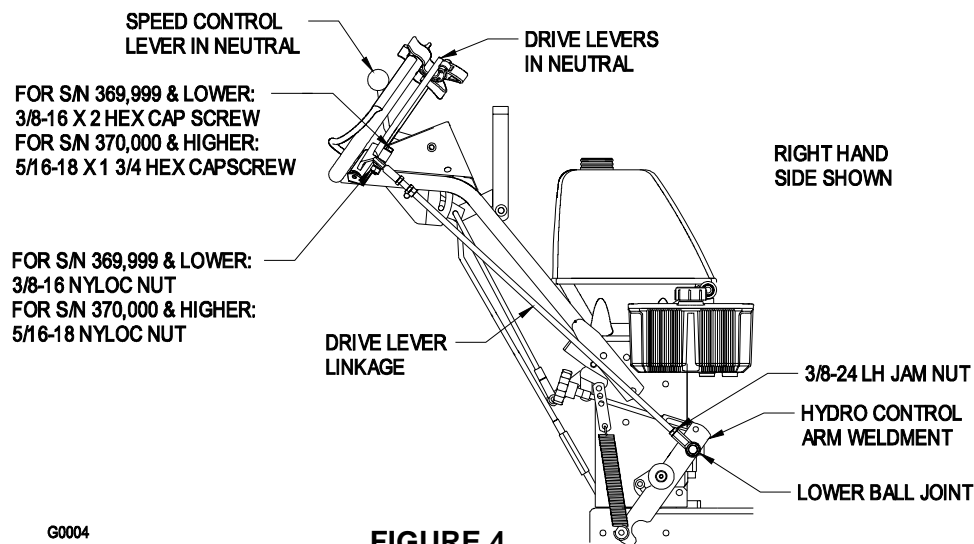

G0004

**FIGURE 4**  
**ECS HANDLES**  
**DRIVE LEVER LINKAGE INSTALLATION**

- 3.14 Connect wiring harness.

**For recoil start models:** Route the long unattached portion of the wiring harness up the left handle and under the console. Connect the connector on the end of the shorter lead to the key switch. Connect the two flag terminals that are in the longer lead to the OPC switch in any order. Continue routing this lead down the right side of the handle and connect the connector on the end of it to the park brake switch. Fasten the harness to the left hand side of the handle using two large ties from the bolt bag. Fasten the harness to the right hand side of the handle using two small ties from the bolt bag. On ECS models fasten the harness to the two small holes in the channel under the console using two small ties from the bolt bag.

**For electric start models:** Route the long unattached portion of the wiring harness up the left handle and under the console. Connect the two flag terminals to the OPC switch in any order. Connect the connector to the key switch. Fasten the harness to the left hand side of the handle using two large ties from the bolt bag. On ECS models fasten the leads connecting to the OPC switch to the small hole in the channel under the console using a small tie from the bolt bag.

3.15 If machine is shipped without muffler installed, install muffler with hardware provided.

3.16 **SERVICE ENGINE:** Refer to Engine Owner's Manual.

3.17 **SERVICE HYDRAULIC OIL**

The machine is shipped with hydraulic oil filled to the top of the baffle in the reservoir. Run the machine for approximately 15 minutes to allow any extra air to purge out of the hydraulic system. Check hydraulic reservoir and if necessary fill the reservoir to the appropriate level with Mobil 1 15W-50 synthetic motor oil. Replace hydraulic reservoir cap and tighten until snug. **Do not overtighten.**

The baffle is labeled "HOT" and "COLD". The oil level varies with the temperature of the oil. The "HOT" level shows the level of oil when it is at 225°F (107°C). The "COLD" level shows the level of the oil when it is a 75°F (24°C). Fill to the appropriate level depending upon the temperature of the oil. For example: If the oil is about 150°F (65°), fill to halfway between the "HOT" and "COLD" levels. If the oil is at room temperature (about 75°F (24°C)), fill only to the "COLD" level.

3.18 **GREASE UNIT: NOTE: UNIT IS NOT GREASED AT THE FACTORY.**

Refer to 5.1.14, for locations and grease amounts.

3.19 Follow pre-start instructions as outlined in Section 4.2.

**NOTE: After starting the engine and engaging the hydro drive, if either of the drive wheels acts sluggish or will not rotate at all, stop engine and refer to Section 5.1.10 on the Hydraulic System Air Purge procedure.**

3.20 Perform any needed adjustments as outlined in the Adjustment Section.

## 4. OPERATION INSTRUCTIONS

### 4.1 Controls

4.1.1 Familiarize yourself with the controls and operation of the unit.

*Carefully read the following information about the controls and their operation.*

4.1.2 Operator Presence Control (OPC) Levers: Located on the upper handle assembly directly above the handle grips. See Figure 5. **When these levers are depressed, the OPC system senses that the operator is in the normal operator's position. When the levers are released, the OPC system senses that the operator has moved from the normal operating position** and will kill the engine if either the speed control lever is **not in the neutral** position or the **PTO is engaged.**

4.1.3 Speed Control Lever: Located in middle of control console, it controls the maximum forward speed and is infinitely variable from neutral (0 mph) to 6.2 mph. Park brake must be disengaged before speed control lever is moved out of neutral or engine will kill.

4.1.4 Drive Levers: Located on each side of the upper handle assembly directly below the handle grips (See Figure 5). These levers individually control the speed and direction of each drive wheel. When the speed control lever is moved out of the neutral position and the neutral lock latches are moved into the drive position, as shown in Figure 5, and the drive levers are released, the drive wheels are engaged in the forward direction.

Squeezing the left hand and/or right hand lever causes the left hand and/or right hand drive wheel respectively to slow down, stop, or reverse, depending on how far each drive lever is "squeezed". Squeezing the drive levers beyond the neutral position causes the drive wheels to engage in the reverse direction regardless of the position of the neutral lock latches and the speed control lever.

- 4.1.5 **Neutral Lock Latch:** Located at the end of the handles. The purpose of these latches is to allow the operator to lock the drive levers in a "neutral" position where neither of the drive wheels are engaged in either a forward or reverse direction (See Figure 5).

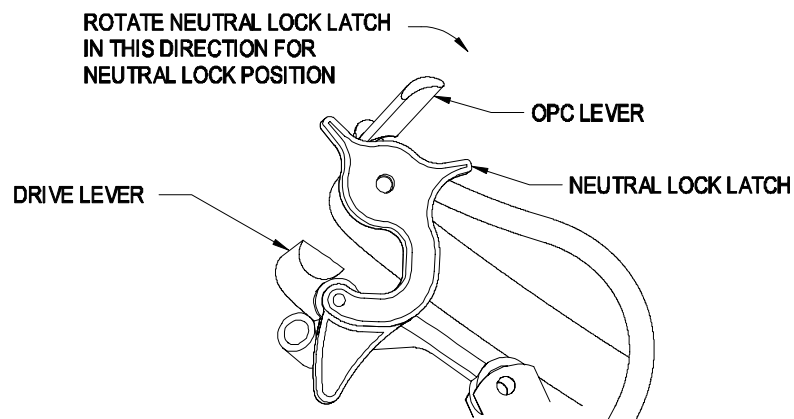

**FIGURE 5**

**DRIVE LEVER, NEUTRAL LOCK LATCH OPERATION**

- 4.1.6 **PTO Engagement:** Located on the left side of the upper handle. To engage the blades, push the lever forward, or away from the operator, until the linkage locks over-center. To disengage the blades, pull the lever to the rear, or towards the operator.

*For manual start engines:* The park brake must be disengaged before the PTO is engaged or the engine will kill.

- 4.1.7 **Choke Control:** Choke is used to aid in starting a cold engine.

The choke control is located on the front left corner of the fuel tank support and is activated by pulling the control outward.

Once the engine has started move the choke control to the off position and move the throttle to the medium or full throttle position.

- 4.1.8 **Throttle Control:** Located on the control console's right side. The throttle is used to control engine speed. Moving the throttle control forward will increase engine speed and moving it to the rear will decrease engine speed.

- 4.1.9 **"Off-Run" Switch (15, 17 & 19 HP Kawasaki Manual Start only):**

Located on the console. Turn key to the "Run" position to allow the engine to be started. Turn key to the "Off" position to shut engine off.

**Operator must have speed control lever in neutral and blade engagement lever fully disengaged to start engine.**

- 4.1.10 **Ignition Switch (19 HP Kawasaki Electric Start only):**

Located on the control console. The ignition switch starts and stops the engine. The switch has three positions "OFF", "ON", and "START". Insert key into switch and rotate clockwise to the "ON" position. Rotate clockwise to the next position to engage the starter (key must be held against spring pressure in this position). When engine starts, release key.

**Operator must have speed control lever in neutral, OPC levers depressed, and blade engagement lever fully disengaged to start engine.**

- 4.1.11 **Park Brake Lever:** Located on the right side of the unit above the hydraulic tank. The brake lever engages the park brake on the drive wheels.

**Pull** the lever **up** and **rearward** to engage the brake.

**Push** the lever **forward** and **down** to disengage the brake.

When parking on a steep slope, the wheels must be chocked or blocked in addition to the brake being engaged. The unit must be tied down and brake engaged when transporting.

Park brake must be disengaged before moving speed control out of neutral or engine will kill.

*For manual start engines:* The park brake must also be disengaged before the PTO is engaged or the engine will kill.

- 4.1.12 **Fuel Shut-Off Valve:** Installed in the fuel line midway between the tank and the engine. The fuel shut-off valve is used to shut off the flow of fuel when parking inside a building, during transportation to and from the job sites, and when the machine will not be used for a few days.

Rotate valve 1/4 turn clockwise to shut fuel off. Rotate valve 1/4 turn counterclockwise to turn fuel on.

- 4.1.13 **Drive Wheel Release Valves:** Located on the top rear corner of the hydrostatic pumps. Drive wheel release valves are used to release the hydro-static drive system to allow the machine to be moved by hand without the engine running. Turn valves one turn counterclockwise to release the drive system.

Turn clockwise to reset the drive system. **Do Not over-tighten.**

- 4.1.14 **Cold Start Kit:** (Manual start units only) Located on the right hand side of engine deck, below the hydro control shield. The cold start kit is used to ease the starting of the unit in cold weather or when the unit has not been operated for a period of time. The cold start kit moves the idler pulley away from the pump belt releasing the tension on the belt, which allows the engine to turn over with less resistance. See Section 4.3.2.

- 4.1.15 **Tracking Adjustment Knob:** Located on the right-hand side of the rear of the fuel tank support. The tracking knob can be turned to adjust the drive so that machine will "track" straight ahead with drive levers released.

## 4.2 Pre-Start

- 4.2.1 Refer to Maintenance and Adjustment Section 5 and perform all of the necessary inspection and maintenance steps.

- 4.2.2 Fill fuel tank. For best results use only clean fresh regular grade **unleaded** gasoline with an octane rating of 87 or higher. Regular grade leaded gasoline may also be used; however, combustion chamber and cylinder head will require more frequent service. See Engine Owner's Manual.

Do not add oil to gasoline.

Do not overfill fuel tank. Never fill the fuel tank so that the fuel level rises above a level that is 1/2" (1.3 cm) below the bottom of the filler neck to allow for fuel expansion and prevent fuel spillage.

- 4.2.3 Make sure you understand the controls, their locations, their functions, and their safety requirements.

## 4.3 OPERATING INSTRUCTIONS

- 4.3.1 Read the Engine Owner's Manual carefully for detailed operating instructions regarding the engine.

Before attempting to operate the unit, refer to Section 1 (Safety) and follow all safety, operating and preparation guidelines as stated in that section.

- 4.3.2 **Starting Engine:** Operator must have **OPC lever depressed, PTO disengaged** and **speed control lever in neutral.**

Lock drive levers in neutral and engage park brake.

**Open** fuel shut-off valve.

**NOTE: A cold weather starting kit has been added for ease of starting in either cold weather or when the unit has not been run for a period of time.**

To use cold start kit: (Manual start units only)

- a) Pull split ring straight out the side of the unit, and hook the ring over the lower rear hydro control shield bolt.
- b) Start engine. Refer to the following guidelines for further starting suggestions.

To engage pump drive (disengage cold start kit)

- a) Pull chain straight out from the side of the unit until the split ring can be removed from the bolt.

**SLOWLY** release tension on chain.

On a cold engine, pull out the choke control.

*For a 15, 17 & 19 HP Kawasaki manual start engine, turn key to “Run” position. Pull recoil rope to start engine.*

*For a 19 HP Kawasaki Electric start engine, OPC levers must be depressed, turn ignition switch to the “start” position. Release the switch when the engine starts.*

After the engine starts and warms up, gradually push down on the choke control and place the throttle control in the full throttle position

**IMPORTANT:** For electric start models, do not crank the engine continuously for more than ten (10) seconds at a time. If the engine does not start, allow a 60 second starter cool-down period between starting attempts. Failure to follow these guidelines can burn out the starter motor.

On a warm engine, place the throttle control **midway** between the “Slow” and “Fast” positions.

After engine warms up, gradually push in the choke control. **DO NOT** run a warm engine with the choke in the “ON” position.

**NOTE: Kawasaki engines generally need to be “choked” even when warm.**

- 4.3.3 Stopping Engine: Lock the drive levers in neutral, disengage PTO, position speed control lever in neutral, and engage the park brake. Place the throttle control **midway** between the “slow” and “fast” positions. Allow the engine to run a minimum of 15 seconds; then turn the key to the “Off” position.

Close the fuel shut off valve if machine will **not** be used for a few days; when parking inside a building; or when transporting the unit.

- 4.3.4 Drive Lever/Neutral Lock Latch Operation:

To lock the drive levers in “**neutral lock**”, squeeze the drive levers back to the “*neutral*” position (See Figure 6 (a)). (**Do Not** squeeze the drive levers all the way back as this will cause the drive wheels to go into full reverse direction). Place thumbs on the inner thumb lobe of the neutral lock latches and rotate them to the “neutral lock” position (See Figure 6 (b)). Release drive levers.



|  <b>CAUTION</b> |  |
|--|--|
| <b>POTENTIAL HAZARD</b>  | <ul style="list-style-type: none"> <li>◆ If the neutral lock latches are not completely engaged the drive levers could unexpectedly slip into the forward drive position.</li> </ul> |
| <b>WHAT CAN HAPPEN</b>   | <ul style="list-style-type: none"> <li>◆ If the drive levers slip into the drive position, the unit could lurch forward and cause injury or property damage.</li> </ul>              |
| <b>HOW TO AVOID THE HAZARD</b>   | <ul style="list-style-type: none"> <li>◆ Be sure the drive levers are past the roller and securely seated at the bottom of the neutral lock latches.</li> </ul>                      |

To place the drive levers in the “**forward**” position, slightly squeeze the drive levers while placing thumbs on the outer thumb lobe of the neutral lock latches (or the index finger on the inner lobe) and rotate them from under the drive levers. **Slowly** and **carefully** release the drive levers (See Figure 6 (d)).

To place the drive levers in the “**reverse**” position, squeeze the drive levers past the neutral position (See Figure 6 (c)).

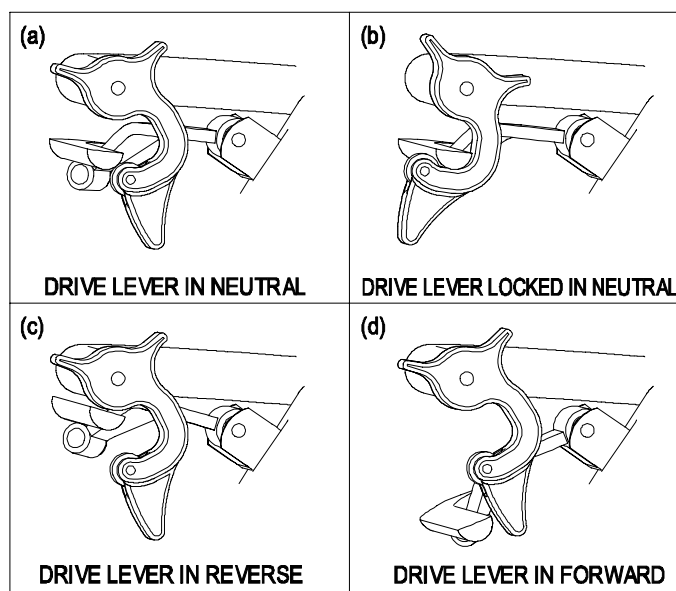

G0176

**FIGURE 6**  
**DRIVE LEVER, NEUTRAL LOCK LATCH OPERATION**

4.3.5 Drive Wheel Engagement/Turning: With drive levers locked in “neutral”, shift speed control lever to desired forward speed.

Note: The park brake must be disengaged before the speed control lever is moved out of neutral or the engine will kill.

Slowly squeeze and hold both drive levers in the neutral position and move both neutral lock latches from the neutral lock position. **Do Not** squeeze both drive levers all the way back, this will cause the drive wheels to be engaged in the reverse direction.

**For Straight Ahead Motion:** Smoothly release both drive levers to engage drive wheels.

**For Turning:** Squeeze the right hand drive lever to turn right and the left hand drive lever to turn left.



To make a “zero turn”, squeeze either the left hand or the right hand drive lever back into the reverse position while the opposite drive lever is in a forward position at an equal but opposite speed.

**For Reverse:** Squeeze both drive levers into the reverse position.

For smooth operation of this machine, avoid quick, jerky movements of the drive levers. Move the drive levers smoothly and deliberately.

4.3.6 **To Stop:** Squeeze drive levers back to the “neutral” position. Move neutral lock latches into the “neutral lock” position and release drive levers. Move the speed control lever to the neutral position.

4.3.7 **PTO Engagement:**

|  <b>DANGER</b>  |  |
|--|--|
| <b>POTENTIAL HAZARD</b>  |  |
| <ul style="list-style-type: none"> <li>◆ The rotating blades under the mower deck are dangerous.</li> </ul>  |  |
| <b>WHAT CAN HAPPEN</b>   |  |
| <ul style="list-style-type: none"> <li>◆ Blade contact can cause serious injury or kill you.</li> </ul>  |  |
| <b>HOW TO AVOID THE HAZARD</b>   |  |
| <ul style="list-style-type: none"> <li>◆ <i>DO NOT</i> put hands or feet under the mower or mower deck when the PTO is engaged.</li> </ul>   |  |
|  <b>DANGER</b>  |  |
| <b>POTENTIAL HAZARD</b>  |  |
| <ul style="list-style-type: none"> <li>◆ An uncovered discharge opening will allow objects to be thrown in an operator’s or bystander’s direction. Also, contact with the blade could occur.</li> </ul>                    |  |
| <b>WHAT CAN HAPPEN</b>   |  |
| <ul style="list-style-type: none"> <li>◆ Thrown objects or blade contact can cause serious injury or death.</li> </ul>   |  |
| <b>HOW TO AVOID THE HAZARD</b>   |  |
| <ul style="list-style-type: none"> <li>◆ Never operate the mower with the discharge deflector raised, removed, or altered unless there is a grass collection system or mulch kit in place and working properly.</li> </ul> |  |

Be sure that all persons are clear of mower deck and discharge area before engaging the PTO. Set throttle to “midway” position. Push the PTO engagement arm forward and down to engage blades. Accelerate to full throttle to begin mowing (See Section 4.1.5).

*For manual start engines:* The park brake must be disengaged before the PTO is engaged or the engine will kill.

4.3.8 **PTO Disengagement:** Pull upward and back completely on the PTO engagement arm to disengage the blades (See Section 4.1.6).

#### 4.4 TRANSPORTING

|  <b>WARNING</b>  |
|---|
| <b>POTENTIAL HAZARD</b> <ul style="list-style-type: none"><li>◆ Loading the mower onto a trailer without strong enough or properly supported ramps could be dangerous.</li></ul>  |
| <b>WHAT CAN HAPPEN</b> <ul style="list-style-type: none"><li>◆ The ramps could collapse causing the unit to fall, which could cause injury.</li></ul>   |
| <b>HOW TO AVOID THE HAZARD</b> <ul style="list-style-type: none"><li>◆ Use proper ramps that are secured to the truck or trailer.</li><li>◆ Keep feet and legs out from under the unit when loading and unloading.</li><li>◆ If necessary, use assistance when loading.</li></ul> |

Be sure fuel shut-off valve is closed.

Use a heavy duty trailer to transport the machine. Engage neutral lock latches and park brake, then block wheels. Securely fasten the machine to the trailer with straps, chains, cables, or ropes. Be sure that the trailer has all necessary lighting and marking as required by law and use a safety chain.

**Note: When transporting machine, be sure to engage the park brakes. Failure to do so can result in damage and/or premature wear to drive train.**

***Do not rely solely on parking brake to hold machine on trailer.***

#### 5. MAINTENANCE & ADJUSTMENTS

|  <b>WARNING</b>   |
|--|
| <b>POTENTIAL HAZARD</b> <ul style="list-style-type: none"><li>◆ While maintenance or adjustments are being made, someone could start the engine.</li></ul>   |
| <b>WHAT CAN HAPPEN</b> <ul style="list-style-type: none"><li>◆ Accidental starting of the engine could seriously injure you or other bystanders.</li></ul>   |
| <b>HOW TO AVOID THE HAZARD</b> <ul style="list-style-type: none"><li>◆ Remove the key from the ignition switch and/or pull the wire(s) off the spark plug(s) before you do any maintenance. Also push the wire(s) aside so it does not accidentally contact the spark plug(s).</li></ul> |

|  <b>WARNING</b>  |
|---|
| <b>POTENTIAL HAZARD</b> <ul style="list-style-type: none"><li>◆ The engine can become very hot.</li></ul>   |
| <b>WHAT CAN HAPPEN</b> <ul style="list-style-type: none"><li>◆ Touching a hot engine can cause severe burns.</li></ul>  |
| <b>HOW TO AVOID THE HAZARD</b> <ul style="list-style-type: none"><li>◆ Allow the engine to cool completely before service or making repairs around the engine area.</li></ul> |

## 5.1 PERIODIC MAINTENANCE

### 5.1.1 Check engine oil level.

Service Interval: **See Engine Owner's Manual**

- a) Make sure mower is on a level surface. Stop engine and wait for all moving parts to stop.
- b) Check with engine cool.
- c) Clean area around dipstick. Remove dipstick and wipe oil off. Reinsert the dipstick (**DO NOT** screw into place). Remove dipstick and check oil level.
- d) If the oil level is low, add oil as specified in the Engine Owner's Manual to bring the oil level up to the "FULL" mark on the dipstick.

**DO NOT OVERFILL.**

**IMPORTANT: DO NOT operate the engine with oil level below the "LOW" (or "ADD") mark or over the "FULL" mark.**

### 5.1.2 Clean engine air cooling system.

Service Interval: **See Engine Owner's Manual**

- a) Stop engine and wait for all moving parts to stop. Remove ignition key or spark plug wire(s).
- b) Clean all debris from engine air intake screen and from around engine shrouding.

### 5.1.3 Clean grass build-up under deck.

**Service Interval: Daily**

- a) Stop engine, wait for all moving parts to stop, and remove key.
- b) Raise deck to the highest position. Lift the front of unit and support unit using jack stands or equivalent support.

|  <b>CAUTION</b> |   |
|--|---|
| <b>POTENTIAL HAZARD</b>  | ◆ Raising the mower deck for service or maintenance relying solely on mechanical or hydraulic jacks could be dangerous.               |
| <b>WHAT CAN HAPPEN</b>   | ◆ The mechanical or hydraulic jacks may not be enough support or may malfunction allowing the unit to fall, which could cause injury. |
| <b>HOW TO AVOID THE HAZARD</b>   | ◆ <b>DO NOT</b> rely solely on mechanical or hydraulic jacks for support. Use adequate jack stands or equivalent support.             |

- c) Clean out any grass build-up from underside of deck and in discharge chute.

### 5.1.4 Check mower blades.

**Service Interval: Daily**

- a) Stop engine, wait for all moving parts to stop, and remove key.
- b) Lift deck and secure in raised position as stated in Section 5.1.3.
- c) Inspect blades and sharpen or replace as required.
- d) Re-install the blades (if they were removed) in the following order (See Figure 7):
  - 1) Install bushing through blade with bushing flange on bottom (grass) side of blade.

- 2) Install bushing/blade combo into spindle.
- 3) Install blade bolt and spring disc washer. Be sure the spring disc washer cone is installed towards the bolt head. Place a block of wood between front or rear baffles and the blade then torque the blade bolts to 55-60 ft-lbs. (75-81 N-m).

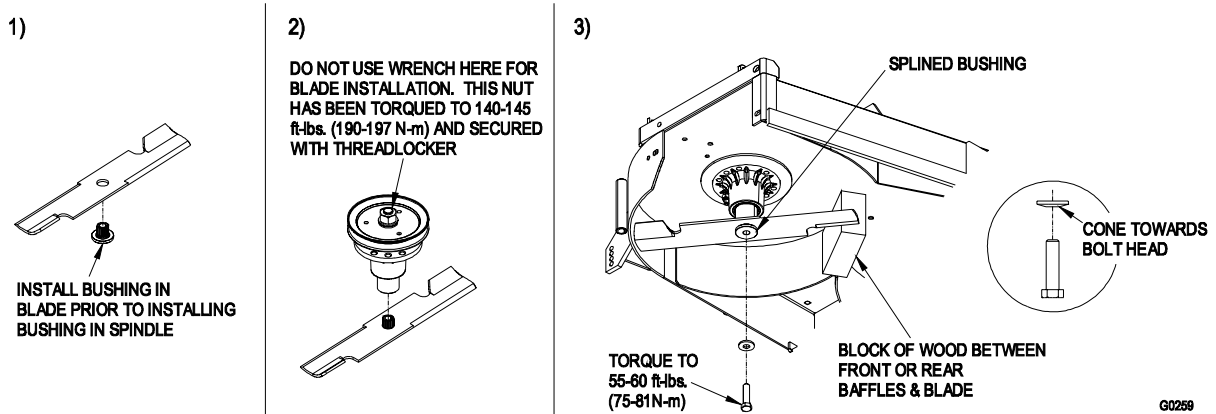

**FIGURE 7**  
**BLADE BOLT INSTALLATION**

**IMPORTANT: DO NOT** use components other than the original blade, blade bushing, spring disc washer, and blade bolt supplied with the unit. Failure to use all original components and assembled as shown will increase the risk of a blade bolt becoming loose or weak after striking a foreign object.

|  <b>CAUTION</b> |   |
|---|---|
| <b>POTENTIAL HAZARD</b>   | ◆ Operating a mower deck with loose or weakened blade bolts can be dangerous.   |
| <b>WHAT CAN HAPPEN</b>  | ◆ A loose or weakened blade bolt could allow a blade rotating at a high speed to come out from under the deck, causing serious injury or property damage. |
| <b>HOW TO AVOID THE HAZARD</b>  | ◆ Always re-install original Exmark blades, blade bushings, spring disc washers, and blade bolts in the correct positions as shown.                       |

5.1.5 Check safety interlock system.

Service Interval: **Daily**

- a) For your safety, your Exmark mower is equipped with Operator Presence Controls (OPC). When either the PTO is engaged, or the speed control lever is not in neutral and both hands are removed from the handles, the mower engine **MUST stop**.
- b) **For Electric Start Units Only:** Check starting circuit. Starter should crank with: *Operator Presence Control levers **depressed**, speed control lever in **neutral**, and PTO **disengaged**.*

Try to start the engine with *OPC levers **disengaged**, speed control lever in **neutral** and PTO **disengaged** - starter **MUST NOT** crank.*

Try to start with, *OPC levers **depressed**, speed control lever in any speed but **neutral** and PTO **disengaged** - starter **MUST NOT** crank.*

Try to start with *OPC levers depressed*, speed control lever in **neutral** and **PTO engaged-starter MUST NOT crank**.

- c) Check OPC circuits. Clear the area. Disengage park brake. Run engine at one-third throttle, then with drive levers and neutral lock latches in "**neutral lock**" position, move the speed control lever out of neutral and release OPC levers - **engine MUST stop**.

Again, run engine at one-third throttle, move the speed control lever to **neutral**, engage blade clutch and release OPC levers - **engine MUST stop**.

Note: Park brake must be disengaged before the speed control lever is moved out of neutral or engine will kill.

*For manual start engines:* The park brake must also be disengaged before the PTO is engaged or the engine will kill.

- d) If machine does not pass any of these tests, **DO NOT** operate. Contact your authorized **EXMARK SERVICE DEALER**.

**IMPORTANT: It is essential that all Operator Safety Mechanisms, be in place and in proper operating condition prior to mowing.**

#### 5.1.6 Check for loose hardware.

Service Interval: **Daily**

- a) Stop engine and wait for all moving parts to stop. Remove ignition key or spark plug wire(s).
- b) Visually inspect machine for any loose hardware or any other possible problem. Tighten hardware or correct the problem before operating.

#### 5.1.7 Service pre-cleaner element and air cleaner.

Service Interval: **See Engine Owner's Manual**

- a) Stop engine and wait for all moving parts to stop. Remove key or spark plug wire(s).
- b) See engine owner's manual for cleaning instructions.

#### 5.1.8 Change engine oil.

Service Interval: **See Engine Owner's Manual**

**NOTE: Change oil after first five (5) hours of operation. Follow engine manufacturer's recommendations for future oil changes.**

- a) Disengage PTO.
- b) Stop engine and wait for all moving parts to stop. Remove ignition key or spark plug wire(s).
- c) Drain oil while engine is warm from operation.
- d) Oil drain valve is located on left hand side of engine. Place pan under machine to catch oil and open valve with 10 mm wrench. Allow oil to drain then close valve.
- e) Replace the oil filter as per Engine Owner's Manual. Clean around oil filter and unscrew filter to remove.

Before reinstalling new filter, apply a thin coating of oil on the surface of the rubber seal. Turn filter clockwise until rubber seal contacts the filter adapter, then tighten filter an additional 2/3 to 3/4 turn.

- f) Clean around oil fill cap and remove cap. Fill to the specified capacity and replace cap. Use oil as specified in Engine Owners Manual. **Do not overfill.**
- g) Start the engine and check for leaks. Stop engine and recheck oil levels.

5.1.9 Check hydraulic oil level.

Service Interval: **40 hr.**

- a) Stop engine and wait for all moving parts to stop.
- b) Clean area around hydraulic reservoir cap and remove cap. Oil level should be to the top of the baffle inside the tank. If not, add oil. **Use only Mobil 1 15W-50 synthetic motor oil.** Replace hydraulic reservoir cap and tighten until snug. **Do not overtighten.**

The baffle is labeled "HOT" and "COLD". The oil level varies with the temperature of the oil. The "HOT" level shows the level of oil when it is at 225° F (107°C). The "COLD" level shows the level of the oil when it is a 75°F (24°C). Fill to the appropriate level depending upon the temperature of the oil. For example: If the oil is about 150°F (65°), fill to halfway between the "HOT" and "COLD" levels. If the oil is at room temperature (about 75°F (24°C)), fill only to the "COLD" level.

5.1.10 Change hydraulic system filter.

Service Interval: **After First 250 hrs, then yearly thereafter.**

Note: Use only Exmark Part No. 1-513211 for Summer use above 32° F (0° C) or Part No. 1-523541 for Winter use below 32° F (0° C). Refer to 2.7.2 for filter specifications.

- a) Place unit on a level surface, stop engine and wait for all moving parts to stop. Remove ignition key or spark plug wire(s).
- b) Carefully clean area around filter. It is important that no dirt or contamination enters the hydraulic system.
- c) Unscrew filter to remove and allow oil to drain from reservoir.

**IMPORTANT:** Before re-installing new filter, fill it completely with Mobil 1 15W-50 and apply a thin coat of oil on the surface of the rubber seal. Turn filter clockwise until rubber seal contacts the filter adapter. Do not tighten yet.

- d) Fill reservoir as stated in Section 5.1.9.
- e) Loosen filter 1/2 turn and allow a small amount of oil to leak from the oil filter (this allows air to be purged from the oil filter and supply hose from the hydraulic reservoir). Turn filter clockwise until rubber seal contacts the filter adapter. Then tighten the filter an additional 2/3 to 3/4 turn.
- f) Raise the rear of the machine up onto jack stands high enough to raise the drive wheels off of the ground. Run machine to allow any other air to be purged from the hydraulic system and recheck the oil level.
- g) If either drive wheel does not rotate, one or both of the charge pumps (located on the top of the main pump as shown in Figure 11) may have lost their "prime". Refer to Section 5.1.11.
- h) **DO NOT** change hydraulic system oil (*except what can be drained when changing filter*) unless it is felt that oil has been contaminated. **Changing oil unnecessarily could damage the hydraulic system by introducing contaminants into the system.**

5.1.11 Hydraulic system air purge procedure.

Air must be purged from the hydraulic system when any hydraulic components, including the oil filter, are removed or any of the hydraulic lines are disconnected.

The critical area for purging air from the hydraulic system is between the oil reservoir and each charge pump located on the top of each variable displacement pump (See Figure 8).

Air in other parts of the hydraulic system will be purged through normal operation once the charge pumps are "primed".

- a) Stop engine and wait for all moving parts to stop. Raise the rear of the machine up onto jack stands high enough to raise the drive wheels off the ground.
- b) Check oil level as stated in Section 5.1.9.
- c) Start engine and move throttle control ahead to full throttle position. Move the speed control lever to the middle speed position and place the drive levers in the “drive” position.

If either drive wheel does not rotate, it is possible to assist the purging of the charge pump by carefully rotating the tire in the forward direction.

**NOTE: It is necessary to lightly touch the charge pump cap with your hand to check the pump temperature. If the cap is too hot to touch, turn off engine. The pumps may be damaged if the pump becomes too hot.**

If either drive wheel still does not rotate continue with step (d).

- d) Thoroughly clean the area around each of the charge pump housings.

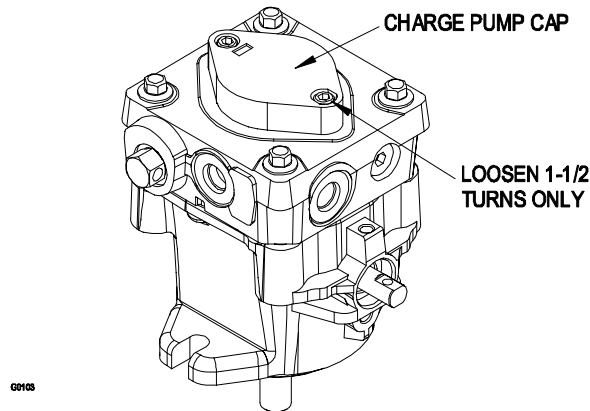

**FIGURE 8  
CHARGE PUMP LOCATION**

- e) To “prime” charge pump, loosen two hex socket head capscrews (shown in Figure 11) **1-1/2 turns only**. **Make sure engine is not running**. Lift charge pump housing upward and wait for a steady flow of oil to flow out from under housing. **Retighten capscrews**. Do this for both pumps. Note: Hydraulic reservoir can be pressurized to up to 5 psi (35 kPa) to speed this process.
- f) If either drive wheel still does not rotate, stop and repeat Steps (d) through (e) above for the respective pump. If tires rotate slowly, the system may prime after additional running. Check oil level as stated in Section 5.1.9.
- g) Allow unit to run several minutes after the charge pumps are “primed” with drive system in the full speed position.  
Check oil level as stated in Section 5.1.9.
- h) Check hydro drive linkage adjustment as stated in Section 5.2.6.

#### 5.1.12 Check tire pressures.

Service Interval: **Pneumatic (air-filled) Drive Tires- 40 hrs.**

**Semi-pneumatic Caster Tires – No maintenance**

- a) Stop engine and wait for all moving parts to stop. Remove ignition key or spark plug wire(s). Check air pressure in drive tires; recommended tire pressure is 12-16 psi (83-110 kPa).
- b) Inflate tires to pressures stated above. Measure the circumference of each drive tire. Adjust tire pressures within the above range to try to make tire circumferences match as closely as possible.



5.1.13 Inspect Belt wear.

Service Interval: **40 hrs.**

- a) Stop engine and wait for all moving parts to stop. Remove ignition key or spark plug wire(s).
- b) Remove deck support belt shield to check mower deck drive belt condition.
- c) Look under engine deck to check the pump drive and clutching belt condition.

5.1.14 Inspect PTO Clutching Belt Tension.

Service Interval: **Check every 2 hrs. for first 8 hrs. operation then check every 40 hrs. thereafter.**

- a) Stop engine and wait for all moving parts to stop.
- b) Engage PTO lever.
- c) Look through the round hole in the left rear corner of the engine deck to inspect blade clutching belt tension. Bolt on blade engagement linkage bellcrank and indicator arm should align within 1/16" (.16 cm) (See Figure 13). Refer to section 5.2.2 for adjustment.

5.1.15 Lubrication

Service Interval: **Refer to Chart.**

- a) Stop engine and wait for all moving parts to stop. Remove ignition key or spark plug wire(s).
- b) Lubricate fittings with one to two pumps of NGLI grade #2 multi-purpose gun grease.

Refer to the following chart for fitting locations and lubrication schedule.

**GREASE LUBRICATION CHART**

| FITTING LOCATIONS           | INITIAL PUMPS | QUANTITY |     |     | SERVICE INTERVAL |
|-----------------------------|---------------|----------|-----|-----|------------------|
|                             |               | 36"      | 48" | 52" |                  |
| 1. Caster Wheel Bearings    | 12            | 2        | 2   | 2   | 8 hours          |
| 2. Caster Pivots            | 2             | 2        | 2   | 2   | 8 hours          |
| 3. PTO Engagement Bellcrank | 1             | 1        | 1   | 1   | 40 hours         |
| 4. Idler Pivot (Pump Drive) | 2             | 1        | 1   | 1   | Yearly           |
| 5. Clutch Arm Pivot         | 1             | 1        | 1   | 1   | 40 hours         |
| 6. Mower Deck Idler Pivots  | 2             | 1        | 1   | 1   | Yearly           |
| 7. Pump Control Bearings    | 2             | 2        | 2   | 2   | 40 hours         |

No. 4 (Idler Pivot)  
Located Under Engine Deck

No. 5 (Clutch Arm Pivot)  
Located Under Engine Deck

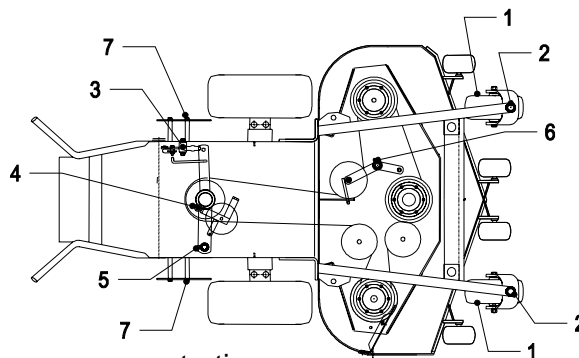

- c) Lubricate pivot points with a spray penetrating lubricant as directed below.

### SPRAY LUBRICANT CHART

| PIVOT POINT  | NO. OF PLACES | SERVICE INTERVAL |
|--------------|---------------|------------------|
| 1. PTO Lever | 1             | Weekly           |

5.1.16 Check spark plugs.

Service Interval: **160 hrs.**

- a) Stop engine and wait for all moving parts to stop.
- b) Remove spark plugs, check condition and adjust plug gap or replace with new plugs. See Engine Owner's Manual.

5.1.17 Remove engine shrouds and clean cooling fins.

Service Interval: **See Engine Owner's Manual**

- a) Stop engine and wait for all moving parts to stop. Remove ignition key or spark plug wire(s).
- b) Remove cooling shrouds from engine and clean cooling fins. Also clean dust, dirt, and oil from external surfaces of engine, which can cause improper cooling.
- c) Make sure cooling shrouds are properly reinstalled. Operating the engine without cooling shrouds will cause engine damage due to overheating.

5.1.18 Change fuel filter.

Service Interval: **As Required**

- a) A fuel filter is installed in the fuel line between the fuel tank and the engine. Replace when necessary.

5.1.19 Refer to Engine Operators Manual for detailed maintenance regarding the engine.

5.1.20 Wheel hub - slotted nut torque specification.

When tightening the slotted nut on the wheel motor tapered shaft:

- a) Torque the slotted nut to 100 ft. lbs (136 N-m).
- b) Further tighten the nut until the next set of slots line up with the cross hole in the shaft.
- c) Replace cotter pin.

Note: Do not use anti-seize compound on the wheel hub

5.1.21 Thread locking adhesives such as "Loctite 242" or "Fel-Pro, Pro-Lock Nut-Type" are used on the following fasteners:

- a) Pump drive sheave setscrews.
- b) Square head setscrews on Hydro pump control arms.
- c) OPC lever setscrews.
- d) Sheave retaining bolt in end of engine crankshaft.
- e) Lower Sheave retaining bolt on clutch arm.
- f) Shoulder bolts in ends of speed control crank.
- g) Fuel tank bulkhead fitting threads.
- h) Cutter housing spindle nut.

Adhesives such as "Loctite RC/609 or RC/680" or "Fel-Pro Pro-Lock Retaining I or Retaining II" are used on the following:

- a) OPC lever hubs and cross-shaft

**NOTE: Care must be used not to bond the bearing, next to each OPC hub, to the cross shaft which could cause binding of the OPC levers and erratic operation.**

- b) Fuel tank studs, where studs are inserted into tank.

5.1.22 An anti-seize compound is used on the following locations:

- a) Between engine crankshaft and pump and blade drive sheaves.
- b) On clutch arm assembly between bearings and shaft and between lower sheave and shaft.
- c) Between pump shafts and sheaves.

5.1.23 Mobil HTS grease (or food-grade antisieze) is used in the following locations:

- a) Between the cutter housing spindle and bearings.
- b) Between the cutter housing spindle and sheave.
- c) Under top cutter housing bearing guard.

5.1.24 Dielectric grease is used on all blade type electrical connections to prevent corrosion and loss of contact.

5.1.25 Check battery charge: (Electric start units only)

Service Interval: **Monthly**

Allowing batteries to stand for an extended period of time without recharging them will result in reduced performance and service life. To preserve optimum battery performance and life, recharge batteries in storage when the open circuit voltage drops to 12.4 volts.

Note: To prevent damage due to freezing, battery should be fully charged before putting away for winter storage.

- a) Check the voltage of the battery with a digital voltmeter. Locate the voltage reading of the battery in the table below and charge the battery for the recommended time interval to bring the charge up to a full charge of 12.6 volts or greater.

**IMPORTANT:** Make sure the negative battery cables are disconnected and the battery charger used for charging the battery has an output of 16 volts and 7 amps or less to avoid damaging the battery (see chart below for recommended charger settings).

| Voltage Reading | Percent Charge | Maximum Charger Settings | Charging Interval    |
|-----------------|----------------|--------------------------|----------------------|
| 12.6 or greater | 100%           | 16 volts/7 amps          | No Charging Required |
| 12.4 – 12.6     | 75 – 100%      | 16 volts/7 amps          | 30 Minutes           |
| 12.2 – 12.4     | 50 – 75%       | 16 volts/7 amps          | 1 Hour               |
| 12.0 – 12.2     | 25 – 50%       | 14.4 volts/4 amps        | 2 Hours              |
| 11.7 – 12.0     | 0 – 25%        | 14.4 volts/4 amps        | 3 Hours              |
| 11.7 or less    | 0%             | 14.4 volts/2 amps        | 6 Hours or More      |

## 5.2 ADJUSTMENTS

### 5.2.1 Cutting height and anti-scalp roller adjustment.

|  <b>WARNING</b>  |  |
|---|--|
| <b>POTENTIAL HAZARD</b> <ul style="list-style-type: none"><li>◆ When the two front support rod hairpins are removed from the mower deck, the weight of the tractor section may cause the front frame to rise suddenly</li></ul> |  |
| <b>WHAT CAN HAPPEN</b> <ul style="list-style-type: none"><li>◆ If the unit rises suddenly, injury may occur.</li></ul>  |  |
| <b>HOW TO AVOID THE HAZARD</b> <ul style="list-style-type: none"><li>◆ Securely hold down the front of the unit when the front support rod hairpins are removed.</li></ul>  |  |

- a) Stop engine and wait for all moving parts to stop.
- b) Install hairpin clips in the holes for the desired cutting height (See Figure 9).

**IMPORTANT: To maintain correct cutting height and rake, check the following for proper adjustment.**

1. The front and rear hairpins are in the same holes with the proper spacers under the hair pins (See Figure 9).
2. The tire pressures are set as directed in Section 5.1.12.
3. The length of the rear deck support link assemblies should average 6.89" (approximately 6 7/8") (17.5 cm) from the center of the ball joint to the center of the furthest hole (See Figure 9).

**NOTE:** All (4) pins must equally support the weight of the deck. Adjustment in the length of the rear deck support assemblies may be necessary. If one side is longer than 6.89" (17.5 cm), than the opposite side must be shorter by the same amount.

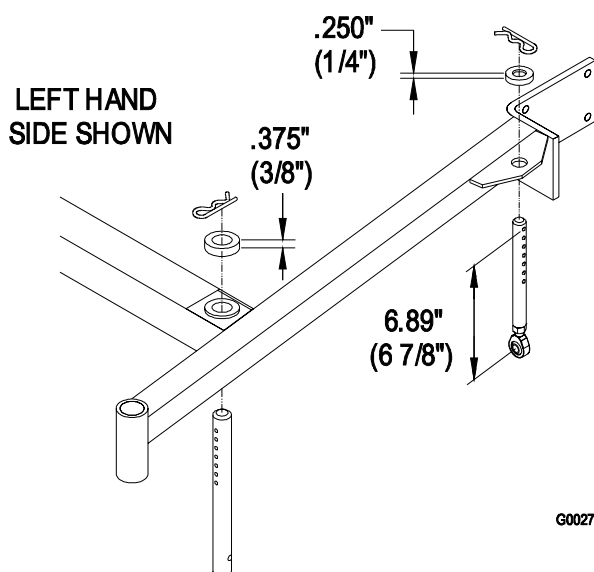

**FIGURE 9**  
**CUTTING HEIGHT ADJUSTMENT**

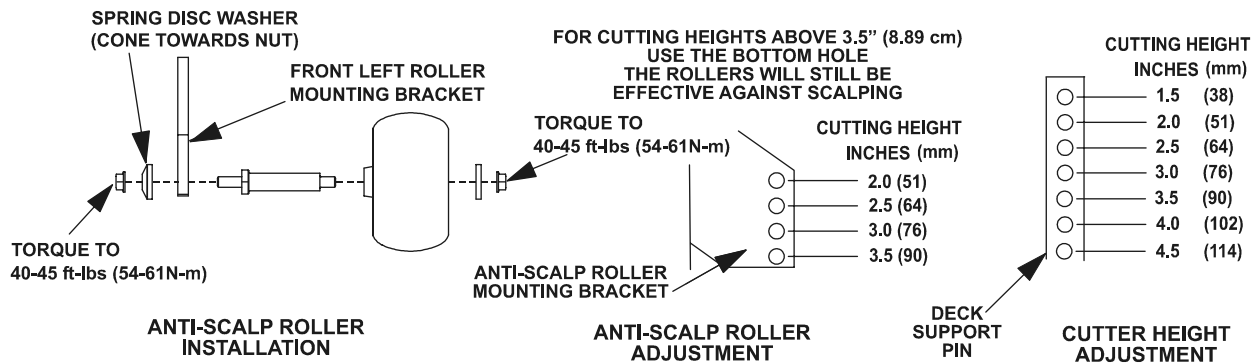

G0280

**FIGURE 10**  
**ANTI-SCALP ROLLER BOLT INSTALLATION**  
**ANTI-SCALP ROLLER AND CUTTING HEIGHT ADJUSTMENT**

c) Adjust anti-scalp rollers For Normal Operating Conditions. Stop engine and wait for all moving parts to stop. Place rollers in one of the positions shown in Figure 10. Rollers will maintain 3/4 in. (1.9 cm) clearance to the ground to minimize gouging and roller wear or damage. **For Maximum Deck Flotation**, place rollers one hole position lower. Rollers should maintain 1/4 in. (.64 cm) minimum clearance to ground.

**Do Not** adjust rollers to support the deck. Be sure spring disc washer is installed with the cone towards the nut. Tighten nuts properly.

d) When operating in extremely rough conditions it may be necessary to position the anti-scalp rollers one or two holes higher than described in "c" to prevent damage to the rollers and/or bolt failure (See Figure 10).

**NOTE:** When anti-scalp rollers are placed in these positions, reduced deck flotation will result.

5.2.2 **PTO Engagement Linkage:** Located between the PTO engagement lever on the left handle and the left rear corner of the engine deck.

- a) Stop engine and wait for all moving parts to stop.
- b) With PTO engaged, adjust the linkage length by loosening the locknut on the turnbuckle and adjusting the turnbuckle so that the bolt on the bellcrank and the indicator arm align with each other within 1/16" (.16 cm) (See Figure 11). Tighten locknut against turnbuckle.

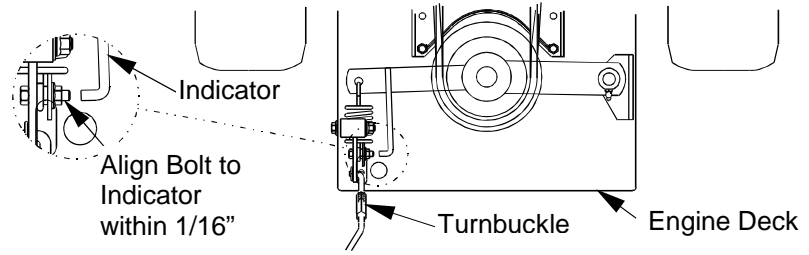

**FIGURE 11**  
**BLADE ENGAGEMENT LINKAGE**

5.2.3 **PTO Safety Switch:** Mounted to a tab on the inside left side of the fuel tank support.

- a) Stop engine and wait for all moving parts to stop. Remove ignition key or spark plug wire(s).
- b) With PTO disengaged and the bellcrank touching the rear of the slot in the engine deck, adjust the PTO safety switch (if needed) until the bellcrank arm is 5/16" from the switch body.
- c) Be sure the bellcrank **DOES NOT** touch the switch body or damage to the switch could occur.

d) Retighten PTO switch mounting hardware.

5.2.4 Engine to Mower Deck Belt:

**No adjustment necessary.**

5.2.5 Pump Drive Belt Tension Adjustment:

**No adjustment necessary.**

5.2.6 Hydro Drive Linkage Adjustment:

a) Adjust Speed Control Linkage and Neutral Safety Switch

1. Stop engine and wait for all moving parts to stop.
2. Move the speed control lever (located on the console) to the full forward position and check the orientation of the tabs on the ends of the speed control crank (See Figure 12). These tabs should be pointing straight down at the 6 o'clock position or slightly forward. Adjust the threaded yoke at the bottom of the speed control linkage (See Figure 12) until the tabs are positioned correctly.
3. Pull the speed control lever back to neutral. Check that the neutral safety switch actuating tab has depressed the plunger of the switch so that there is about 5/16" (.79 cm) between the tab and the switch (See Figure 12). If necessary, move the switch fore and aft.

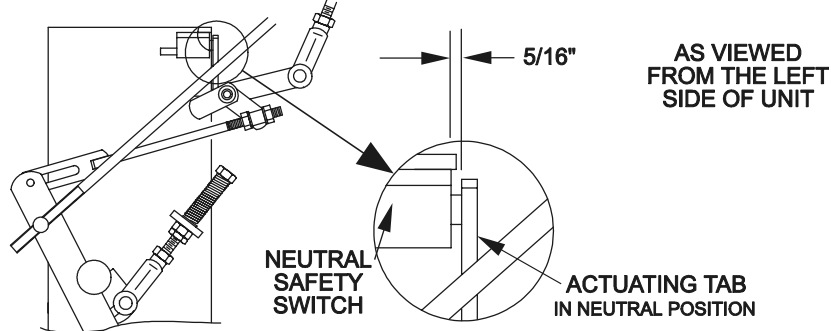
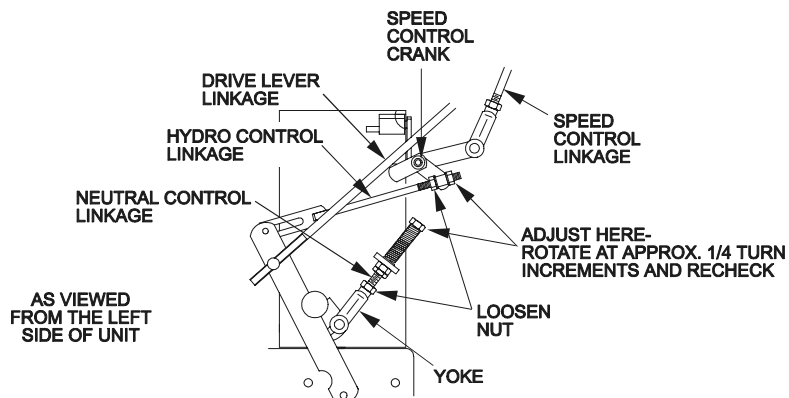

**FIGURE 12**  
**NEUTRAL SAFETY SWITCH ADJUSTMENT**

b) Adjust Neutral Control Linkages

1. Raise the rear of the machine up onto jack stands high enough to raise the drive wheels off of the ground.
2. Start the engine and move the throttle ahead to the full throttle position. Place the neutral lock latches in the "forward" position as shown in Figure 6 and move the speed control lever to the "mid-speed" position.  
Note: The OPC levers must be held down whenever the speed control lever is out of the neutral position or the engine will kill.
3. Squeeze the respective drive lever until an increased resistance is felt, this is where neutral should be.

If the wheel turns while holding the drive lever in neutral, the neutral control linkages need to be adjusted. If wheels stop then go to step 7.



**FIGURE 13**

**HYDRO DRIVE LINKAGE ADJUSTMENT**

4. Loosen the nut against the neutral control linkage yoke (See Figure 13).
  5. Adjust the neutral control linkage until the respective drive wheel stops when the lever is pulled against the neutral spring (neutral position). Turn the adjusting bolt approximately 1/4 turn clockwise if the wheel is turning in reverse or turn the bolt approximately 1/4 turn counter-clockwise if the wheel is turning forward. Release the drive lever to the forward drive position and squeeze back into the neutral position. Check to see if the wheel stops. If not, repeat the above adjustment procedure.
  6. Make this adjustment on both sides.
  7. After adjustments are made and the wheels stop when the drive levers are in the neutral position, tighten the nuts against the yokes.
- c) Adjust Hydro Control Linkages:

1. Place the speed control lever in the “neutral” position.

*Note: Neutral lock latches should still be “unlocked” and in the “forward” position.*

This adjustment is again made with rear of machine on jack stands and engine running at full throttle. OPC levers will have to be held down whenever speed control lever is moved out of the neutral position.

2. Loosen the front nut on **left** hydro control linkage as shown in Figure 13. Turn the rear control linkage adjusting nut counter-clockwise until wheel rotates forward. Turn the rear nut of left control link clockwise 1/4 of a turn at a time, stopping to move the speed control forward and back to neutral, until left wheel stops rotating forward. Turn the rear nut an additional 1/2 turn and tighten the front nut making sure not to put a bind on the linkage. Make sure flat part of linkage is perpendicular to pin part of swivel (See Figure 14).

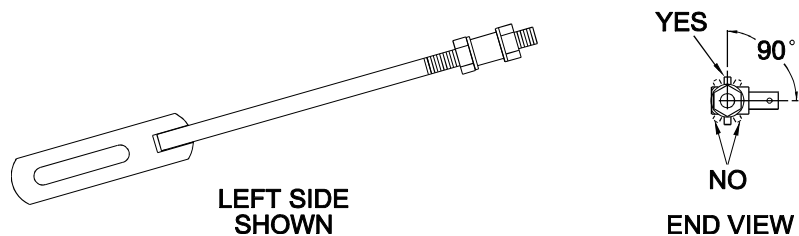

**FIGURE 14**

**HYDRO CONTROL LINK/SWIVEL ADJUSTMENT**

After adjusting the left hydro control linkage, move the speed control lever to the mid-speed position and then back to the neutral position.

Recheck the left drive wheel rotation to see if further adjustment is necessary - be sure the speed control lever is in the neutral position.

***If inconsistent neutral occurs, check to be sure both springs are properly tightened on the speed control lever under the console - especially the rear pivot spring.***

Repeat above adjustments if necessary.

3. Place the speed control lever in neutral. Adjust the right side linkage by turning the quick track knob counter-clockwise until the tire begins to rotate forward. Begin to retighten the knob clockwise about 1/4 turn at a time, stopping to move the speed control forward and back to neutral. Recheck the drive wheel rotation to see if further adjustment is necessary.
4. The spring that keeps tension on the knob should normally not need adjustment. However if adjustment is needed, adjust to where length of spring is about 1" (25.4 mm) between the washers. Adjust spring length by turning nut at front of spring.

d) Drive Lever Linkage Adjustment

1. With rear of machine still on jack stands and engine running at full throttle, disengage the park brake and move the speed control lever to the midway position. Move the respective drive lever upward until it reaches the **neutral** position and engage neutral lock latches (See Figure 15). If the tire rotates in either direction, the length of the drive lever link will need to be adjusted.
2. Adjust the linkage length by loosening the jam nuts at both ends of the linkage and rotating the linkage in the ball joints. Lengthen the linkage if the tire is turning in reverse and shorten the linkage if the tire is creeping forward. Tighten the jam nuts at both ends. Release and re-engage the neutral lock latch checking that the tire stops. Continue this process until the tire is at a dead stop.

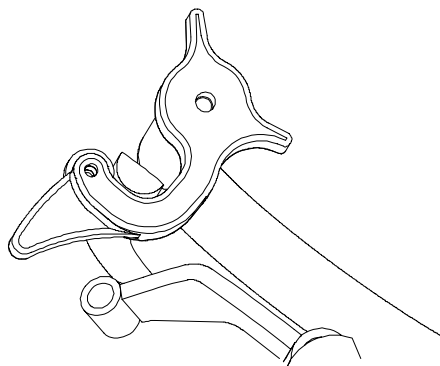

**FIGURE 15**

**DRIVE LEVER AND LATCH IN NEUTRAL POSITION**

3. Make this adjustment for both sides.

e) Tracking Adjustment

1. Stop engine and wait for all moving parts to stop. Raise the rear of the machine, remove jack stands and carefully lower the machine to the ground. (Check the drive tire pressure and tire circumference (See Section 5.1.12.)
2. Run the unit and observe the tracking on a level, smooth, hard surface such as concrete or asphalt.
3. If the unit tracks to one side or the other, turn the quick track knob. Turn the knob right to "steer" right; turn the knob left to "steer" left.



### 5.2.7 Hydro Pump Spring Tension Setting

- a) For medium or heavy duty drive conditions such as operation with a sulky on steep slopes, a higher spring force may be required on the hydro pump control arms to prevent the drive system from stalling.
- b) For a heavier drive setting, relocate the spring anchor link to either the “medium” or “heavy duty” positions as shown in Figure 16. The spring anchor links are attached to the upper rear corner of the hydro drive shields on the left and right hand sides of the machine.

**Note: In the “medium” or “heavy duty” positions, the drive lever forces at the upper handle will also be increased.**

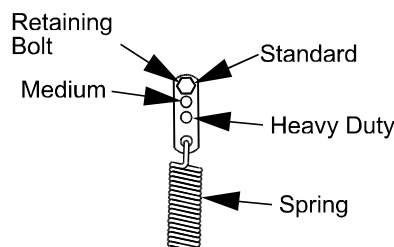

**FIGURE 16**  
**HYDRO PUMP SPRING TENSION SETTING**

### 5.2.8 Park Brake Adjustment:

- a) Shut off engine and wait for all moving parts to stop.
- b) Disengage the park brake.
- c) Remove the hairpin in the park brake linkage. Turn the linkage in the yoke until there is 3/16” (.48 cm) to 1/4” (.64 cm) clearance between the park brake tire bars and the tires with the park brake disengaged. Re-install the hairpin.

## 6. WASTE DISPOSAL

### 6.1 MOTOR OIL DISPOSAL

Engine oil and hydraulic oil are both pollutants to the environment. Dispose of used oil at a certified recycling center or according to your state and local regulations.

### 6.2 BATTERY DISPOSAL

|  <b>DANGER</b>               |  |
|---|--|
| <b>POTENTIAL HAZARD</b>   |  |
| ◆ Battery electrolyte contains sulfuric acid, which is poisonous and can cause severe burns                     |  |
| <b>WHAT CAN HAPPEN</b>  |  |
| ◆ Swallowing electrolyte can be fatal or if it touches skin can cause severe burns.                             |  |
| <b>HOW TO AVOID THE HAZARD</b>  |  |
| ◆ Wear safety glasses to shield eyes, and rubber gloves to protect skin and clothing when handling electrolyte. |  |
| ◆ Do not swallow electrolyte.   |  |

Federal law states that batteries should not be placed in the garbage. Management and disposal practices must be within relevant federal, state, or local laws.

If a battery is being replaced or if the unit containing the battery is no longer operating and is being scrapped, take the battery to a local certified recycling center. If no local recycling is available return the battery to any certified battery reseller.

## 7. TROUBLE SHOOTING

### 7.1 MOWER TRACKS TO LEFT OR RIGHT.

- a) Check the drive tire pressure and tire circumference (See Section 5.1.12).
- b) Turn knob on the right hydro control linkage in the direction that the mower needs to be adjusted to. Turn the knob in 1/4 turn increments until the mower tracks correctly.

### 7.2 MOWER CUTS UNEVENLY.

- a) Check the drive tire pressure and tire circumference (See Section 5.1.12).  
A more uniform cutting height may be obtained with higher tire pressure on rough terrain. A lower tire pressure provides more flotation.
- b) Check deck support pins. Hairpin clips must be in the same hole position on each support pin (See Section 5.2.1).
- c) Check deck support alignment and check mounting brackets to be sure all bolts are tight.
- d) Check blades tip to tip for straightness. (They should be within 3/16", or one blade width from being in line.)

### 7.3 ENGINE WILL NOT START.

- a) Make sure battery has a full charge (Electric start only). (See Section 5.1.25)
- b) Check that choke is in the "ON" position for a cold engine or in the "OFF" position for a warm engine (See Section 4.3.2).

**NOTE: Kawasaki engines may need to be choked even when warm.**

- c) Make sure the key switch is in the "ON" position (15, 17 & 19 HP Kawasaki Manual start).
- d) Make sure the speed control lever is in the "true neutral" position (See Section 5.2.6).
- e) Check that the PTO is disengaged and the PTO switch is depressed.
- f) Make sure the OPC levers are depressed. (Electric start only)
- g) Check that there is fuel in the tank and that the fuel valve is open.
- h) Check that the spark plug wire(s) are properly connected.
- i) Check for loose or faulty wiring connections. If it is necessary to disconnect wire connectors, **Do Not** pull on the wires while disconnecting.
- j) Check for corrosion at all wiring connections. Even minor corrosion may cause a faulty connection. Clean connector terminals thoroughly with electrical contact cleaner, apply dielectric grease and reconnect.

**IMPORTANT: It is essential that all operator safety mechanisms be connected and in proper operating condition prior to mower use.**

**NOTE: After carefully checking the above steps, attempt to start the engine. If it does not start, contact your authorized Exmark service dealer.**

### ENGINE TROUBLESHOOTING

When a problem occurs, do not overlook the simple causes. For example, starting problems could be caused by an empty fuel tank.

The following table lists some of the common causes of trouble.

Do not attempt to service or replace major items or any items that call for special timing or adjustment procedures (such as valves, governor, etc.). Have this work done by your **Engine Service Dealer**.

### ENGINE TROUBLESHOOTING TABLE

| <b>PROBLEM</b>        | <b>NO FUEL</b> | <b>IMPROPER FUEL</b> | <b>DIRT IN FUEL LINE</b> | <b>DIRTY AIR FILTER</b> | <b>FAULTY SPARK PLUG</b> | <b>ENGINE OVERLOADED</b> | <b>BLOCKED FUEL FILTER</b> | <b>INCORRECT OIL LEVEL</b> | <b>DIRTY AIR SCREEN</b> |
|-----------------------|----------------|----------------------|--------------------------|-------------------------|--------------------------|--------------------------|----------------------------|----------------------------|-------------------------|
| Will not start        | X              |                      | X                        | X                       | X                        | X                        | X                          |                            |                         |
| Hard starting         | X              | X                    | X                        | X                       | X                        | X                        | X                          |                            |                         |
| Stops suddenly        | X              |                      | X                        | X                       |                          | X                        | X                          | X                          | X                       |
| Lacks power           |                | X                    | X                        | X                       | X                        | X                        | X                          | X                          | X                       |
| Operates erratically  |                | X                    | X                        | X                       | X                        | X                        | X                          |                            | X                       |
| Knocks or pings       |                | X                    |                          |                         |                          | X                        |                            |                            | X                       |
| Skips or misfires     |                | X                    | X                        | X                       | X                        |                          |                            |                            | X                       |
| Backfires             |                |                      | X                        | X                       | X                        | X                        |                            |                            | X                       |
| Overheats             |                |                      | X                        | X                       |                          | X                        |                            | X                          | X                       |
| High fuel consumption |                |                      |                          | X                       | X                        | X                        |                            |                            | X                       |

## 8. WIRING DIAGRAMS

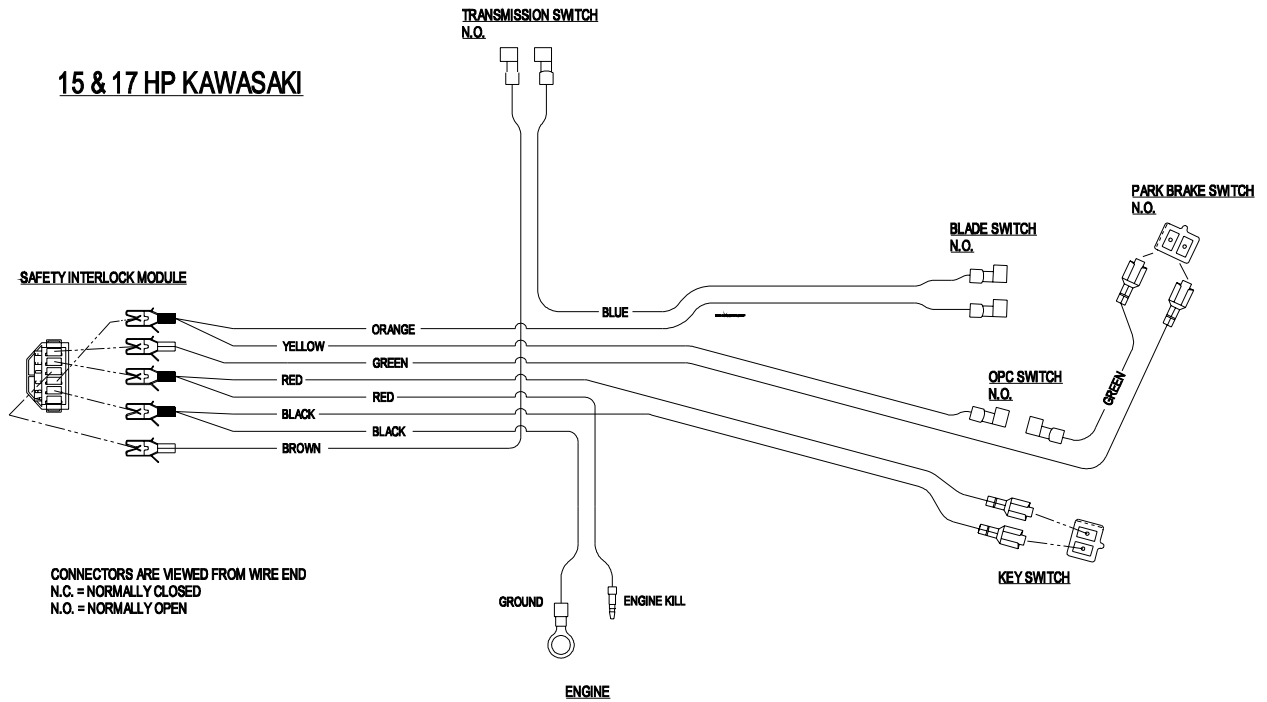

### 17 HP KAWASAKI ELECTRIC START

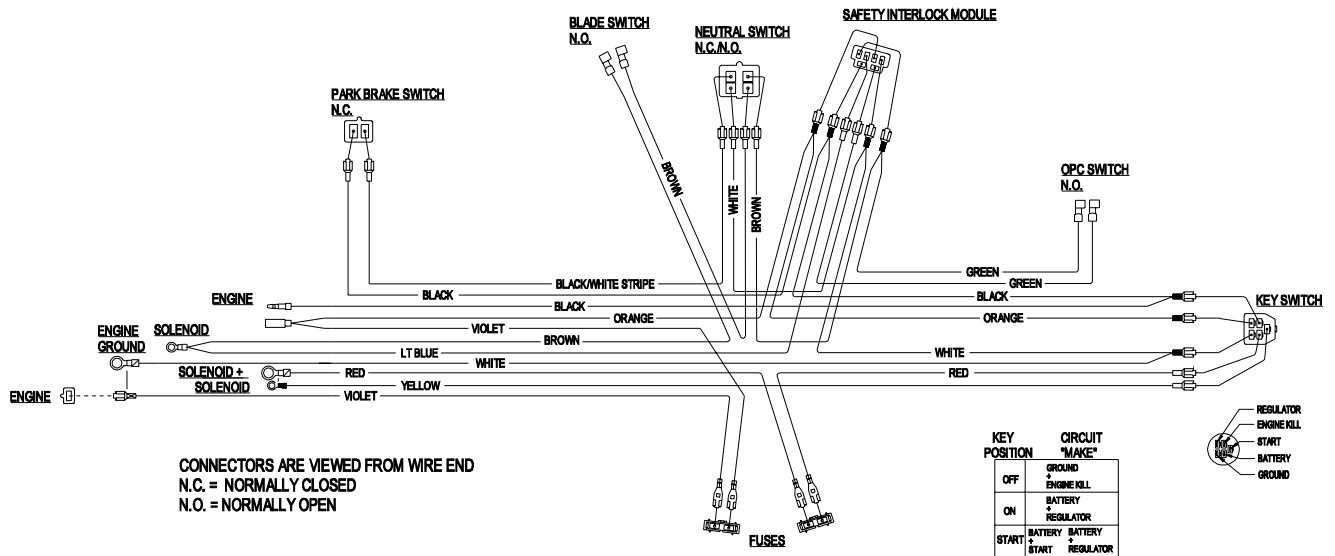

### 9. HYDRAULIC DIAGRAM

G0175

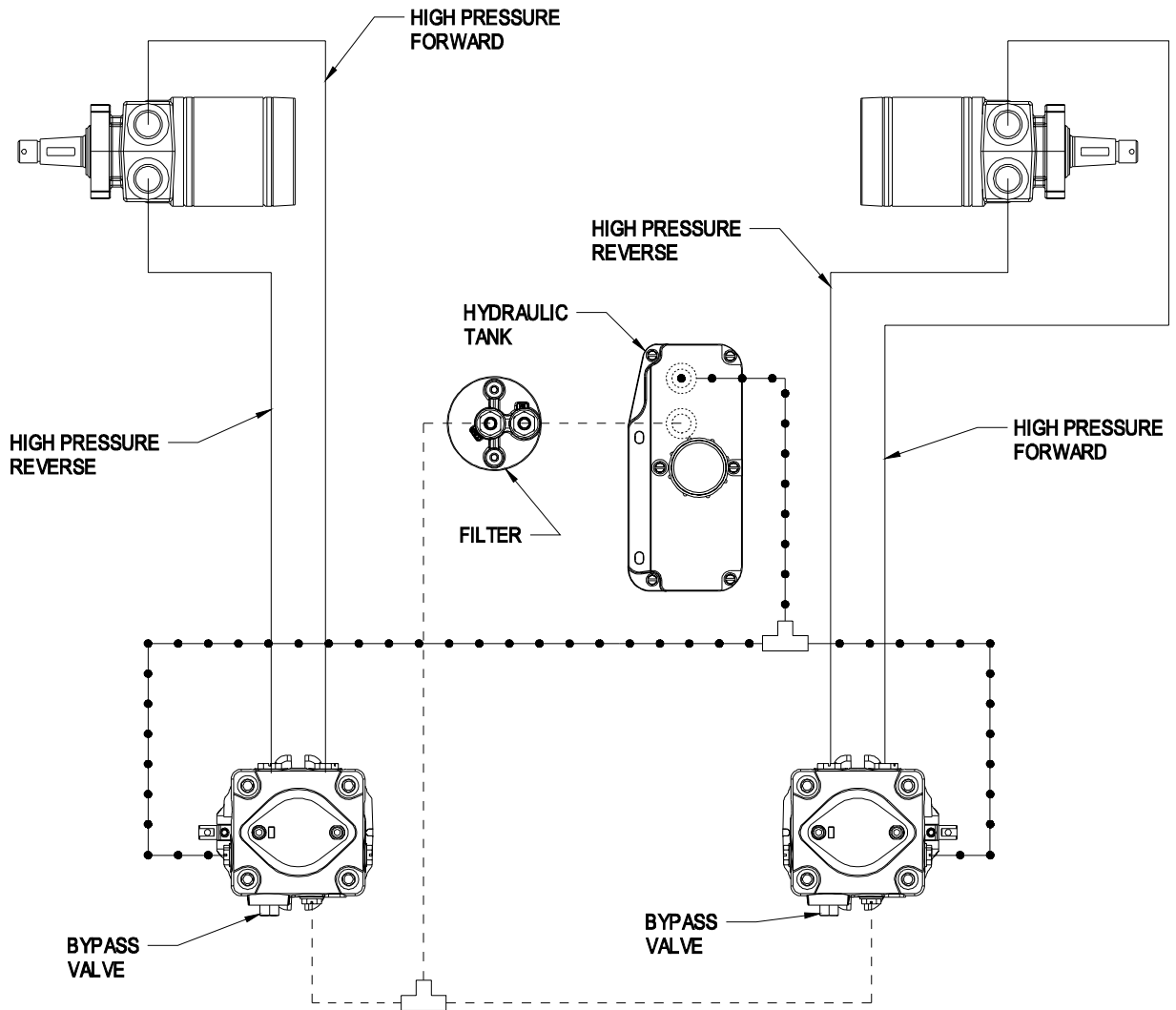

- HIGH PRESSURE
- - - CHARGE PUMP INLET
- CASE DRAIN

↑  
FRONT  
OF UNIT

10.

**2-Year Limited Warranty  
Exmark Turf Equipment**

(For units purchased on or after October 1, 2004)

**Conditions and Products Covered**

Exmark Mfg. Co. Inc. and its affiliate, Exmark Warranty Company, pursuant to an agreement between them, jointly warrant on the terms and conditions herein, that we will repair, replace or adjust any part manufactured by Exmark and found by us (in the exercise of our reasonable discretion) to be defective in factory materials or workmanship for a period of two years.

This warranty applies to Exmark turf equipment purchased on or after October 1, 2004 sold in the US or Canada. This warranty may only be assigned or transferred to a second (or third) owner by an authorized Exmark dealer. The warranty period commences upon the date of the original retail purchase.

Products

Warranty Period

- |  |  |
|--|--|
| • All Products (except as noted below) | 2 years                                    |
| • All Attachments and Accessories      | 1 year                                     |
| • Metro 21 Series                      | 1 year                                     |
| • Belts and Tires                      | 90 days                                    |
| • Battery                              | 1 Year Prorated                            |
| • Engine*                              | Warranty is covered by engine manufacturer |

\*Please refer to the engine manufacturer's warranty statement that is included in the literature packet. We are not authorized to handle warranty adjustments on engines.

This warranty only includes the cost of parts and labor.

**Items and Conditions Not Covered**

This warranty does not cover the following:

- Pickup and delivery charges to and from any authorized Exmark Service Dealer.
- Any damage or deterioration due to normal use, wear and tear, or exposure.
- Cost of regular maintenance service or parts, such as filters, fuel, lubricants, tune-up parts, and adjustments.
- Any product or part which has been altered or misused or required replacement or repair due to normal wear, accidents, or lack of proper maintenance.
- Any repairs necessary due to use of parts, accessories or supplies, including gasoline, oil or lubricants, incompatible with the turf equipment or other than as recommended in the operator's manual or other operational instructions provided by Exmark.

All warranty work must be performed by an authorized Exmark Service Dealer using Exmark approved replacement parts.

**Instructions for Obtaining Warranty Service**

1. Contact any Exmark Service Dealer to arrange service at their dealership. To locate a dealer convenient to you, access our website at [www.exmark.com](http://www.exmark.com). U.S. Customers may also call 402-223-6375.
2. Bring the product and your proof of purchase (sales receipt) to the Exmark Service Dealer.

If for any reason you are dissatisfied with the Service Dealer's analysis or with the assistance provided, contact us at:

Exmark Customer Service Department  
The Exmark Warranty Company  
2101 Ashland Avenue  
Beatrice, NE 68310  
402-223-6375 or  
[service@exmark.com](mailto:service@exmark.com)

**Owner's Responsibilities**

The Exmark turf equipment, including any defective part, must be returned to an authorized Exmark service dealer within the warranty period. This warranty extends only to turf equipment operated under normal conditions. You must properly service and maintain your Exmark product as described in the operator's manual. Such routine maintenance, whether performed by a dealer or by you, is at your expense.

As a condition to this warranty, customer shall have read the operator's manual and shall have completed and submitted to Exmark Warranty Company, within the prescribed time, the Exmark warranty registration.

**General Conditions**

The sole liability of Exmark and Exmark Warranty Company with respect to this warranty shall be repair and replacement as set forth herein. **Neither Exmark nor Exmark Warranty Company shall have any liability for any other cost, loss or damage, including but not limited to, any incidental or consequential loss or damage.**

In particular, we shall have no liability or responsibility for:

- Expenses related to gasoline, oil or lubricants.
- Travel time, overtime, after hours time or other extraordinary repair charges or charge relating to repairs or replacements outside of normal business hours at the place of business of the authorized Exmark service dealer.
- Rental of like or similar replacement equipment during the period of any warranty, repair or replacement work.
- Any telephone or telegram charges or travel charges.
- Loss or damage to person or property other than that covered by the terms of this warranty.
- Any claims for lost revenue, lost profit or additional cost as a result of a claim of breach of warranty.
- Attorney's fees.

No Claim of breach of warranty shall be cause for cancellation or rescission of the contract of sale of any Exmark mower.

There are no understandings, agreements, representations, or warranties, express or implied, including but not limited to any regarding the merchantability (that product is fit for ordinary use) or fitness for use (that product is fit for a particular purpose), not specified herein, respecting the equipment which is the subject of this warranty.

**Some states do not allow exclusions of incidental or consequential damages, or limitations on how long an implied warranty lasts, so the above exclusions and limitations may not apply to you.**

This warranty gives you specific legal rights, and you may also have other rights which vary from state to state.

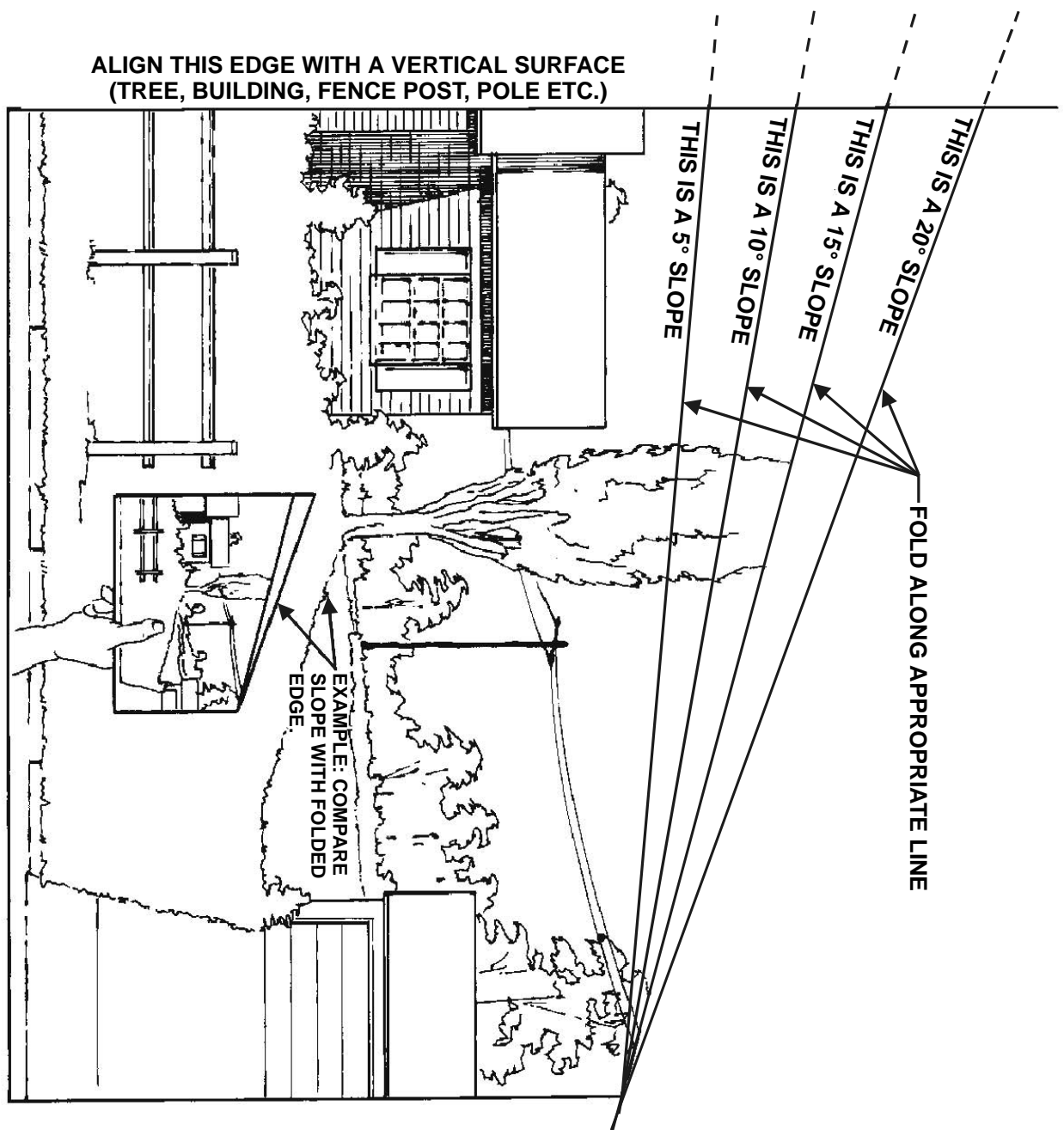

## SEE EXMARK'S COMPLETE LINE OF ACCESSORIES

### RIDING ACCESSORIES

CUSTOM RIDE SEAT SUSPENSION SYSTEM  
DECK LIFT ASSIST KIT  
HITCH KIT  
LIGHT KIT  
MICRO-MULCH SYSTEM  
ROLL OVER PROTECTION SYSTEM (ROPS)  
SNOW BLADE  
SUN SHADE  
TRASH CONTAINER  
TURF STRIPER  
ULTRA VAC COLLECTION SYSTEM  
ULTRA VAC QUICK DISPOSAL SYSTEM

### WALK BEHIND ACCESSORIES

GRASS CATCHER  
MICRO-MULCH SYSTEM  
STEERABLE SULKY  
SULKY HITCH KIT  
TURF STRIPER

Check us out on the Web:

**[www.exmark.com](http://www.exmark.com)**



#### WARNING

The engine exhaust from this product contains chemicals known to the State of California to cause cancer, birth defects, or other reproductive harm.

©1997-2005  
EXMARK MFG. CO. INC.  
INDUSTRIAL PARK BOX 808  
BEATRICE, NE 68310  
ALL RIGHTS RESERVED

PART NO. 103-9188  
(402) 223-6300  
FAX (402) 223-5489

PRINTED IN U.S.A.

