

---

---



## FOREWORD

---

This Arctic Cat Service Manual contains service, maintenance, and troubleshooting information for the 2010 Arctic Cat ATV 150. This manual is designed to aid service personnel in service-oriented applications.

This manual is divided into sections. Each section covers a specific ATV component or system and, in addition to the standard service procedures, includes disassembling, inspecting, and assembling instructions. When using this manual as a guide, the technician should use discretion as to how much disassembly is needed to correct any given condition.

The service technician should become familiar with the operation and construction of each component or system by carefully studying this manual. This manual will assist the service technician in becoming more aware of and efficient with servicing procedures. Such efficiency not only helps build consumer confidence but also saves time and labor.

All Arctic Cat ATV publications and decals display the words Warning, Caution, Note, and At This Point to emphasize important information. The symbol  **WARNING** identifies personal safety-related information. Be sure to follow the directive because it deals with the possibility of severe personal injury or even death. A **CAUTION** identifies unsafe practices which may result in ATV-related damage. Follow the directive because it deals with the possibility of damaging part or parts of the ATV. The symbol  **NOTE:** identifies supplementary information worthy of particular attention. The symbol  **AT THIS POINT** directs the technician to certain and specific procedures to promote efficiency and to improve clarity.

At the time of publication, all information, photographs, and illustrations were technically correct. Some photographs used in this manual are used for clarity purposes only and are not designed to depict actual conditions. Because Arctic Cat Inc. constantly refines and improves its products, no retroactive obligation is incurred.

All materials and specifications are subject to change without notice.

Keep this manual accessible in the shop area for reference.

**Product Service and  
Warranty Department  
Arctic Cat Inc.**

**ARCTIC CAT**<sup>®</sup>

**TABLE OF CONTENTS**

Click on blue text to go.

**8ad SdV**

<b>1. General Information/Specifications</b>	<b>1</b>
<b>2. Periodic Maintenance/Tune-Up</b>	<b>2</b>
<b>3. Engine/Transmission</b>	<b>3</b>
<b>4. Fuel/Lubrication/Cooling</b>	<b>4</b>
<b>5. Electrical System</b>	<b>5</b>
<b>6. Drive System</b>	<b>6</b>
<b>7. Suspension</b>	<b>7</b>
<b>8. Steering/Frame</b>	<b>8</b>
<b>9. Controls/Indicators</b>	<b>9</b>

150

**ATV**  
**Service Manual**

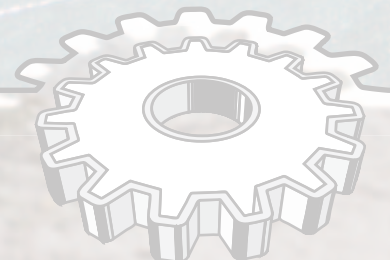

# SECTION 1 - GENERAL INFORMATION

---

---

## TABLE OF CONTENTS

---

General Specifications .....	1-2
Torque Specifications .....	1-2
Torque Conversions (ft-lb/N-m) .....	1-3
Tightening Torque (General Bolts) .....	1-3
Break-In Procedure .....	1-3
Gasoline - Oil - Lubricant .....	1-3
Genuine Parts .....	1-4
Preparation For Storage .....	1-4
Preparation After Storage.....	1-5

## General Specifications\*

CHASSIS	
Dry Weight (approx)	157.9 kg (349 lb)
Length (overall)	177.8 cm (69.9 in.)
Height (overall)	103.8 cm (40.9 in.)
Width (overall)	95.0 cm (37.4 in.)
Brake Type	Double Drum w/Parking Brake (Front) Hydraulic Disc (Rear)
Tire Size	(Front) AT21 x 7-10 (Rear) AT22 x 10-10
Tire Inflation Pressure	(Front) 27.6 kPa (4 psi) (Rear) 24.1 kPa (3.5 psi)
MISCELLANY	
Gas Tank Capacity	8.7 L (2.3 U.S. gal.)
Engine Oil Capacity	1.0 L (1.06 U.S. qt)
Transmission Lubricant Capacity	(Overhaul) 400 ml (13.5 fl/oz) (Change) 300 ml (10.0 fl/oz)
Gasoline (recommended)	87 Octane Regular Unleaded
Engine Oil (recommended)	Arctic Cat ACX All Weather (Synthetic)
Brake Fluid	DOT 4
Taillight/Brakelight	12V/5W/21W (2)
Parking Lights	12V/5W (2)
Headlight	12V/35W/35W (2)
Starting System	Electric w/Kick Start (Emergency)

\* Specifications subject to change without notice.

## Torque Specifications

DRIVE TRAIN COMPONENTS			
Part	Part Bolted To	Torque	
		ft-lb	N-m
Engine Mounting Through Bolt	Frame	29	39
Engine Mounting Bracket Cap Screw	Frame	29	39
Gear Case	Swing Arm	50	68
Wheel Lug Nut	Hub	32	44
Hub Nut	Axle	50	68
Rear Axle Nut*	Axle	86	117
EXHAUST COMPONENTS			
Exhaust Pipe	Cylinder Head	25	34
ELECTRICAL COMPONENTS			
Starter Motor Lead Nut	Starter	36 in.-lb	5
Starter Motor Mounting Cap Screw	Crankcase	7	10



STEERING COMPONENTS			
Part	Part Bolted To	Torque	
		ft-lb	N-m
Handlebar Clamp Cap Screw	Steering Head	15	20
Steering Post Support Block	Frame	15	20
Steering Post Nut	Steering Post	50	68
Steering Knuckle	Steering Knuckle	32	44
Tie Rod End Nut	Steering Arm	29	40
Tie Rod End Nut	Steering Knuckle	32	44
Tie Rod Lock Nut	Tie Rod	22	30
BRAKE COMPONENTS			
Brake Hose Union Bolt	Master Cylinder	24	33
Brake Bleed Screw	Caliper	56 in.-lb	5
Brake Caliper Mounting Cap Screw	Swing Arm Housing	24	33
Master Cylinder	Handlebar	9	12
Brake Pad Alignment Pin (Rear)	Brake Caliper	13	18
Brake Caliper (Rear)	Swing Arm Housing	24	33
SUSPENSION COMPONENTS (Front)			
A-Arm Pivot Nut	Frame	32	44
Front Shock Absorber Mounting Nut* (Upper/Lower)	Frame/A-Arm	29	39
SUSPENSION COMPONENTS (Rear)			
Swing Arm Pivot Nut	Frame	50	68
Rear Shock Absorber Mounting Nut (Upper/Lower)	Frame/Swing Arm	29	39
Axle Housing Cap Screw	Swing Arm	50	68
ENGINE/TRANSMISSION			
Cylinder Head Nut	Cylinder	14	19
Cylinder Head Cap Screw	Crankcase	7	10
Rotor/Flywheel Nut	Crankshaft	40	55
Drive Sprocket Lock Plate	Driveshaft	40	55
Crankcase Cap Screw	Crankcase	7	10
Engine Oil Screen/Filter Cap	Crankcase	11	15
Shift Detent Bolt	Transmission Case	35	48
Camshaft Chain Tensioner Cover Bolt	Cam Chain Tensioner	36 in.-lb	4
Camshaft Chain Tensioner Mount	Cylinder Head	9	12
Centrifugal Clutch Housing*	Driveshaft	40	54
Driven Pulley Retaining Nut	Driven Shaft (Transmission)	43	59
Drive Plate Nut*	Fixed Drive Face	43	59
Drive Pulley Nut	Crankshaft	43	59
Transmission Drain Plug	Transmission	21	29
Balancer Nut*	Balancer Shaft	32	45
Oil Pump	Crankcase	7	10
Oil Pump Baffle	Crankcase	7	10
Oil Pump Driven Gear*	Oil Pump	7	10
Starter One-Way Drive Nut*	Crankshaft	68	92
Magneto Cover	Crankcase	7	10
Outer Magneto Cover	Magneto Cover	7	10
CVT Cover Cap Screw	Crankcase	7	10

\* w/Red Loctite #271

## Torque Conversions (ft-lb/N-m)

ft-lb	N-m	ft-lb	N-m	ft-lb	N-m	ft-lb	N-m
1	1.4	26	35.4	51	69.4	76	103.4
2	2.7	27	36.7	52	70.7	77	104.7
3	4.1	28	38.1	53	72.1	78	106.1
4	5.4	29	39.4	54	73.4	79	107.4
5	6.8	30	40.8	55	74.8	80	108.8
6	8.2	31	42.2	56	76.2	81	110.2
7	9.5	32	43.5	57	77.5	82	111.5
8	10.9	33	44.9	58	78.9	83	112.9
9	12.2	34	46.2	59	80.2	84	114.2
10	13.6	35	47.6	60	81.6	85	115.6
11	15	36	49	61	83	86	117
12	16.3	37	50.3	62	84.3	87	118.3
13	17.7	38	51.7	63	85.7	88	119.7
14	19	39	53	64	87	89	121
15	20.4	40	54.4	65	88.4	90	122.4
16	21.8	41	55.8	66	89.8	91	123.8
17	23.1	42	57.1	67	91.1	92	125.1
18	24.5	43	58.5	68	92.5	93	126.5
19	25.8	44	59.8	69	93.8	94	127.8
20	27.2	45	61.2	70	95.2	95	129.2
21	28.6	46	62.6	71	96.6	96	130.6
22	29.9	47	63.9	72	97.9	97	131.9
23	31.3	48	65.3	73	99.3	98	133.3
24	32.6	49	66.6	74	100.6	99	134.6
25	34	50	68	75	102	100	136

## Tightening Torque (General Bolts)

Type of Bolt	Thread Diameter A (mm)	Tightening Torque
(Conventional or 4 Marked Bolt) 	5	12-36 in.-lb
	6	36-60 in.-lb
	8	7-11 ft-lb
	10	16-25 ft-lb
(7 Marked Bolt) 	5	24-48 in.-lb
	6	6-8 ft-lb
	8	13-20 ft-lb
	10	29-43 ft-lb

## Break-In Procedure

A new ATV and an overhauled ATV engine require a “break-in” period. The first 10 hours (or 200 miles) are most critical to the life of this ATV. Proper operation during this break-in period will help assure maximum life and performance from the ATV.

During the first 10 hours (or 200 miles) of operation, always use less than 1/2 throttle. Varying the engine RPM during the break-in period allows the components to “load” (aiding the mating process) and then “unload” (allowing components to cool). Although it is essential to place some stress on the engine components during break-in, care should be taken not to overload the engine too often. Do not pull a trailer or carry heavy loads during the 10-hour break-in period.

When the engine starts, allow it to warm up properly. Idle the engine several minutes until the engine has reached normal operating temperature. Do not idle the engine for excessively long periods of time.

During the break-in period, a maximum of 1/2 throttle is recommended; however, brief full-throttle accelerations and variations in driving speeds contribute to good engine break-in.

After the completion of the break-in period, the engine oil and oil filter should be changed. Other maintenance after break-in should include checking of all prescribed adjustments and tightening of all fasteners.

## Gasoline - Oil - Lubricant

### RECOMMENDED GASOLINE

The recommended gasoline to use is 87 minimum octane regular unleaded. In many areas, oxygenates (either ethanol or MTBE) are added to the gasoline. Oxygenated gasolines containing up to 10% ethanol, 5% methane, or 5% MTBE are acceptable gasolines.

When using ethanol blended gasoline, it is not necessary to add a gasoline antifreeze since ethanol will prevent the accumulation of moisture in the fuel system.

### CAUTION

**Do not use white gas. Only Arctic Cat approved gasoline additives should be used.**

## RECOMMENDED ENGINE OIL

### CAUTION

Any oil used in place of the recommended oil could cause serious engine damage. Do not use oils which contain graphite or molybdenum additives. These oils can adversely affect clutch operation. Also, not recommended are racing, vegetable, non-detergent, and castor-based oils.

The recommended oil to use is Arctic Cat ACX All Weather synthetic engine oil, which has been specifically formulated for use in this Arctic Cat engine. Although Arctic Cat ACX All Weather synthetic engine oil is the only oil recommended for use in this engine, use of any API certified SM 5W-50 oil is acceptable.

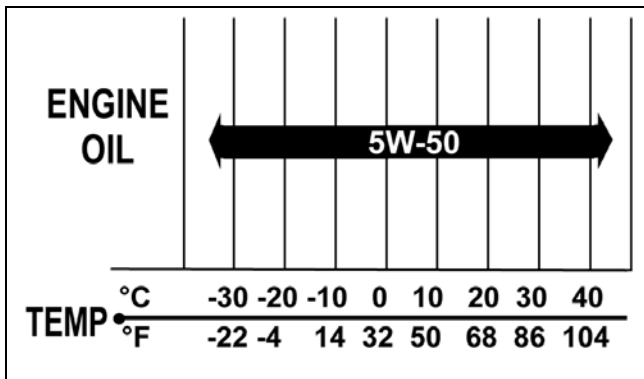

## RECOMMENDED TRANSMISSION LUBRICANT

The recommended lubricant is Arctic Cat Gear Lube or an equivalent gear lube which is SAE approved 80W-90 hypoid. This lubricant meets all the lubrication requirements of the Arctic Cat ATV front differential and rear drive.

## FILLING GAS TANK

### ⚠ WARNING

Always fill the gas tank in a well-ventilated area. Never add fuel to the ATV gas tank near any open flames or with the engine running. DO NOT SMOKE while filling the gas tank.

Since gasoline expands as its temperature rises, the gas tank must be filled to its rated capacity only. Expansion room must be maintained in the tank particularly if the tank is filled with cold gasoline and then moved to a warm area.

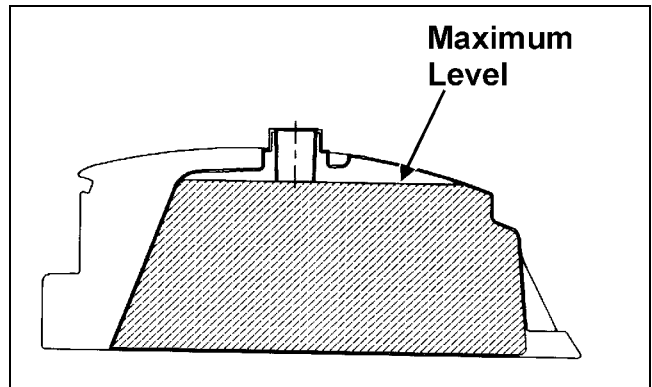

ATV0049B

### ⚠ WARNING

Do not overflow gasoline when filling the gas tank. A fire hazard could materialize. Always allow the engine to cool before filling the gas tank.

### ⚠ WARNING

Do not over-fill the gas tank.

Tighten the gas tank cap securely after filling the tank.

## Genuine Parts

When replacement of parts is necessary, use only genuine Arctic Cat ATV parts. They are precision-made to ensure high quality and correct fit. Refer to the appropriate Illustrated Parts Manual for the correct part number, quantity, and description.

## Preparation For Storage

### CAUTION

Prior to storing the ATV, it must be properly serviced to prevent rusting and component deterioration.

Arctic Cat recommends the following procedure to prepare the ATV for storage.

1. Clean the seat cushion (cover and base) with a damp cloth and allow it to dry.
2. Clean the ATV thoroughly by washing dirt, oil, grass, and other foreign matter from the entire ATV. Allow the ATV to dry thoroughly. DO NOT get water into any part of the engine or air intake.

3. Either drain the gas tank or add Fuel Stabilizer to the gas in the gas tank. Remove the air filter housing cover and air filter. Start the engine and allow it to idle; then using Arctic Cat Engine Storage Preserver, slowly inject the preserver into the air filter opening for a period of 10 to 20 seconds; then stop the engine. Install the air filter and housing cover.

**CAUTION**

Rapid induction of oil or any liquid into a four-cycle engine can cause "hydraulic-lock" resulting in severe engine damage.

**CAUTION**

If the interior of the air filter housing is dirty, clean the area before starting the engine.

4. Drain the carburetor float chamber.
5. Plug the exhaust hole in the exhaust system with a clean cloth.
6. Apply light oil to the upper steering post bushing and plungers of the shock absorbers.
7. Tighten all nuts, bolts, cap screws, and screws. Make sure rivets holding components together are tight. Replace all loose rivets. Care must be taken that all calibrated nuts, cap screws, and bolts are tightened to specifications.
8. Disconnect the battery cables; then remove the battery, clean the battery posts and cables, and store in a clean, dry area.

**CAUTION**

This maintenance-free battery should be charged at the recommended rate every 30 days or permanent damage may occur if the battery completely discharges.

9. Store the ATV indoors in a level position.

**CAUTION**

Avoid storing outside in direct sunlight and avoid using a plastic cover as moisture will collect on the ATV causing rusting.

## Preparation After Storage

Taking the ATV out of storage and correctly preparing it will assure many miles and hours of trouble-free riding. Arctic Cat recommends the following procedure to prepare the ATV.

1. Clean the ATV thoroughly.
2. Clean the engine. Remove the cloth from the exhaust system.
3. Check all control wires and cables for signs of wear or fraying. Replace if necessary.
4. Change the engine oil and filter.
5. Charge the battery; then install. Connect the battery cables.

**CAUTION**

The ignition switch must be in the OFF position prior to installing the battery or damage may occur to the ignition system.

**CAUTION**

Connect the positive battery cable first; then the negative.

6. Check the entire brake systems (fluid level, pads, etc.), all controls, headlights, taillight, brakelight, and headlight aim; adjust or replace as necessary.
7. Tighten all nuts, bolts, cap screws, and screws making sure all calibrated nuts, cap screws, and bolts are tightened to specifications.
8. Check tire pressure. Inflate to recommended pressure as necessary.
9. Make sure the steering moves freely and does not bind.
10. Check the spark plug. Clean or replace as necessary.

1



# SECTION 2 - PERIODIC MAINTENANCE/TUNE-UP

---

---

## TABLE OF CONTENTS

---

Periodic Maintenance Chart.....	2-2
Periodic Maintenance.....	2-3
Lubrication Points.....	2-3
Air Filter.....	2-3
Valve/Tappet Clearance.....	2-4
Testing Engine Compression.....	2-5
Spark Plug.....	2-5
Muffler/Spark Arrester.....	2-6
Engine Oil - Filter.....	2-6
Transmission Lubricant.....	2-7
Drive Chain.....	2-8
Headlight/Taillight-Brakelight.....	2-8
Shift Lever.....	2-9
Brake Systems.....	2-10
Burnishing Brake Pads (Rear).....	2-12
Checking/Replacing V-Belt.....	2-12



## Periodic Maintenance Chart

A = Adjust    I = Inspect  
 C = Clean    L = Lubricate  
 D = Drain    R = Replace  
 T = Tighten

Item	Initial Service After Break-In (First Mo or 100 Mi)	Every Day	Every Month or Every 100 Miles	Every 3 Months or Every 300 Miles	Every 6 Months or Every 500 Miles	Every Year or Every 1500 Miles	As Needed
Battery	I		I				C
Air Filter/Drain Tube	I	I	C*				R
Valve/Tappet Clearance	I				I		A
Spark Plug	I			I			R (4000 Mi or 18 Mo)
Muffler/Spark Arrester					C		R
Gas/Vent Hoses	I	I					R (2 Yrs)
Gas Tank Valve						I	C
Throttle Cable	I	I			C-L		A-R
Carb Float Chamber				D*			
Engine RPM (Idle)	I				I		A
Engine Oil Level		I					A
Engine Oil - Screen	C				C*		C
Drive Chain	I	I					C-L
Transmission Lubricant	I			I		R	A
Tires/Air Pressure	I	I					A-R
Steering Components	I	I		I			R
V-Belt	I					I	R
Suspension (Ball joint boots, tie rods)	I	I		I*			R
Nuts/Cap Screws/Screws	I		I				T
Ignition Timing						I	
Headlight/Taillight-Brakelight	I	I					R
Switches	I	I					R
Shift Lever					I		A-L
Choke Cable		I			C-L		R
Handlebar Grips		I					R
Handlebar	I	I					R
Gauges/Indicators	I	I					R
Frame/Welds/Racks	I		I		I		
Electrical Connections					I		C
Complete Brake System	I	I		C			L-R
Brake Pads/Shoes	I			I*			R
Brake Fluid	I			I			R (2 Yrs)
Brake Hoses	I			I			R (4 Yrs)

\* Service/Inspect more frequently when operating in adverse conditions.



## Periodic Maintenance

This section has been organized into sub-sections which show common maintenance procedures for the Arctic Cat ATV.

■NOTE: Arctic Cat recommends the use of new gaskets, lock nuts, and seals and lubricating all internal components when servicing the engine/transmission.

■NOTE: Some photographs and illustrations used in this section are used for clarity purposes only and are not designed to depict actual conditions.

■NOTE: Critical torque specifications are located in Section 1.

### SPECIAL TOOLS

A number of special tools must be available to the technician when performing service procedures in this section. Refer to the current Special Tools Catalog for the appropriate tool description.

Description	p/n
Compression Tester Kit	0444-213
Tappet Adjuster	0444-189

■NOTE: Special tools are available from the Arctic Cat Service Parts Department.

## Lubrication Points

It is advisable to lubricate certain components periodically to ensure free movement. Apply light oil to the components using the following list as reference.

- A. Throttle Lever Pivot/Cable Ends
- B. Brake Lever Pivot
- C. Front Brake Pivot/Clevis
- D. Choke Cable Upper End
- E. Shift Lever/Ball Joints
- F. Idle RPM Screw (Carburetor)

## Air Filter

Use the following procedure to remove the filter and inspect and/or clean it.

## CLEANING AND INSPECTING FILTER

### CAUTION

Failure to inspect the air filter frequently if the vehicle is used in dusty, wet, or muddy conditions can damage the engine.

1. Remove the seat.
2. Remove the cap screws securing the air filter housing cover.

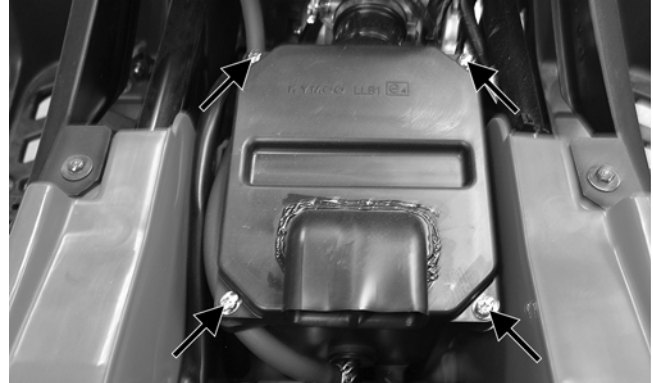

TR003A

3. Remove the filter element and screens from the filter housing.



TR020A

4. Fill a wash pan larger than the filter with a non-flammable cleaning solvent; then dip the filter in the solvent and wash it.

■NOTE: Foam Filter Cleaner and Foam Filter Oil are available from Arctic Cat.

5. Dry the filter.
6. Put the filter in a plastic bag; then pour in air filter oil and work the filter.

### CAUTION

A torn air filter can cause damage to the ATV engine. Dirt and dust may get inside the engine if the element is torn. Carefully examine the element for tears before and after cleaning it. Replace the element with a new one if it is torn.

7. Clean any dirt or debris from inside the air cleaner. Make sure no dirt enters the carburetor.
8. Place the filter in the air filter housing making sure it is properly seated and secure with the clamp.
9. Install the air filter housing cover and secure with the retaining clips; then install the seat making sure it locks securely.

### CHECKING/DRAINING DRAIN TUBE

Periodically check the drain tube for gasoline or oil accumulation. If noticed, remove the drain tube cap from beneath the housing and drain the gasoline or oil into a suitable container; then install and secure the tube cap.

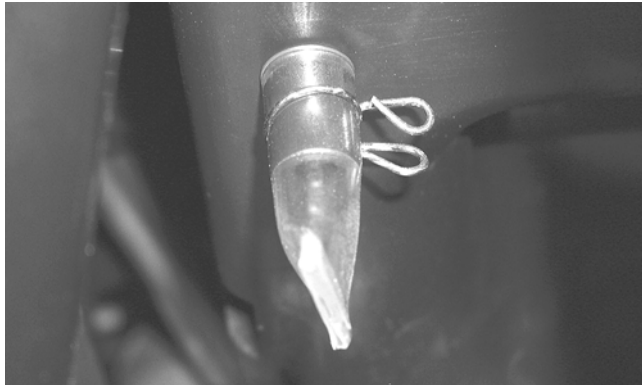

KM114

---

## Valve/Tappet Clearance

---

To check and adjust valve/tappet clearance, use the following procedure.

■NOTE: The seat assembly, side panels, and gas tank must be removed for this procedure.

1. Remove the timing inspection plug; then remove the cylinder head cover (see Section 3 - Removing Top-Side Components).
2. Remove the outer magneto cover from the right side; then remove the oil through and spring.

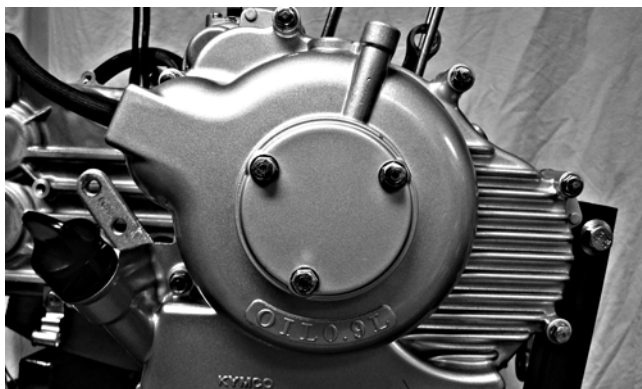

TR198



TR047

3. Using a socket and ratchet on the flywheel nut, rotate the crankshaft so the "T" mark on the flywheel aligns with the index mark on the right-side crankcase cover.

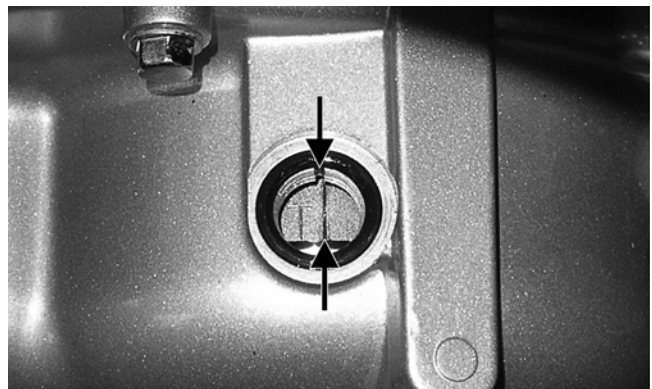

TR043A

■NOTE: At this point, the round hole in the camshaft gear should be up.

4. Check intake and exhaust tappets for proper clearance using an appropriate thickness gauge. If clearance is within specifications, proceed to step 7.

■NOTE: Refer to the appropriate specifications in Section 3 for the proper valve/tappet clearance.

5. On the tappet to be adjusted, loosen the jam nut; then using Tappet Adjuster, turn the tappet to obtain the specified clearance (clockwise to decrease, counterclockwise to increase).



TR045

6. Holding the tappet adjuster at the proper clearance, tighten the jam nut securely; then recheck tappet clearance.
7. Place the cylinder head cover with a new O-ring into position; then tighten the cover securely.



KM703

8. Install the timing inspection plug; then install the oil through and spring into the crankshaft.



TR197

9. Install the crankcase cover aligning the oil hole with the oil passage in the crankcase.

## Testing Engine Compression

To test engine compression, use the following procedure.

1. Remove the high tension lead from the spark plug.
2. Using compressed air, blow any debris from around the spark plug.

### **⚠ WARNING**

**Always wear safety glasses when using compressed air.**

3. Remove the spark plug; then attach the high tension lead to the plug and ground the plug on the cylinder head well away from the spark plug hole.
4. Attach the Compression Gauge.

**NOTE:** The engine must be warm and the battery must be fully charged for this test.

5. While holding the throttle lever in the full-open position, crank the engine over with the electric starter until the gauge shows a peak reading (five to 10 compression strokes).

**NOTE:** The compression should be within a range of 210-230 psi in the full-open throttle position.

6. If compression is abnormally low, verify the following items.
  - A. Starter cranks engine over.
  - B. Gauge functions properly.
  - C. Throttle lever in the full-open position.
  - D. Valve/tappet clearance correct.
  - E. Valve not bent or discolored.
  - F. Valve seat not discolored.

**NOTE:** To service valves, see Section 3.

7. Pour approximately 30 ml (1 fl oz) of oil into the spark plug hole, attach the gauge, and test compression.
8. If compression is now evident, service the piston rings (see Section 3).

## Spark Plug

A light brown insulator indicates that the plug is correct. A white or dark insulator indicates that the engine may need to be serviced or the carburetor may need to be adjusted. To maintain a hot, strong spark, keep the plug free of carbon.

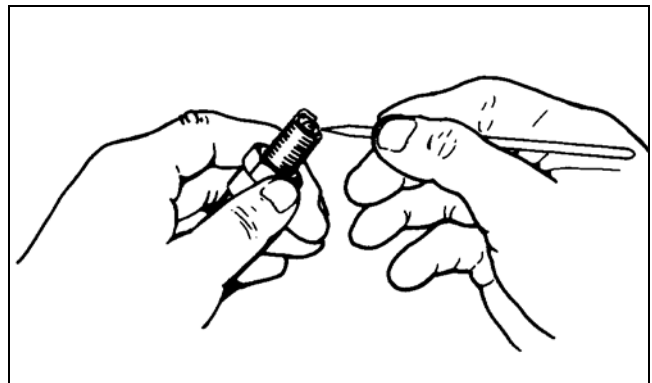

ATV-0051

### **CAUTION**

**Before removing the spark plug, make sure to clean the area around the spark plug. Dirt could enter engine when removing or installing the spark plug.**

Adjust the gap to 0.6 mm (0.024 in.) for proper ignition. Use a wire feeler gauge to check the gap.

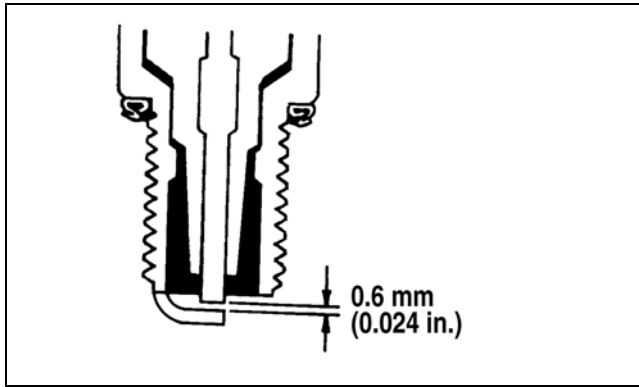

ATV0052D

When installing the spark plug, make sure to tighten it securely. A new spark plug should be tightened 1/2 turn once the washer contacts the cylinder head. A used spark plug should be tightened 1/8-1/4 turn once the washer contacts the cylinder head.

## Muffler/Spark Arrester

The muffler has a spark arrester which must be periodically cleaned. At the intervals shown in the Periodic Maintenance Chart, clean the spark arrester using the following procedure.

### **⚠ WARNING**

**Wait until the muffler cools to avoid burns.**

1. Remove the cap screw (1) securing the spark arrester (2) to the muffler assembly; then carefully remove the spark arrester.



KM139A

2. Using a soft wire brush, clean the carbon from the screen (3) taking care not to tear or damage the screen.

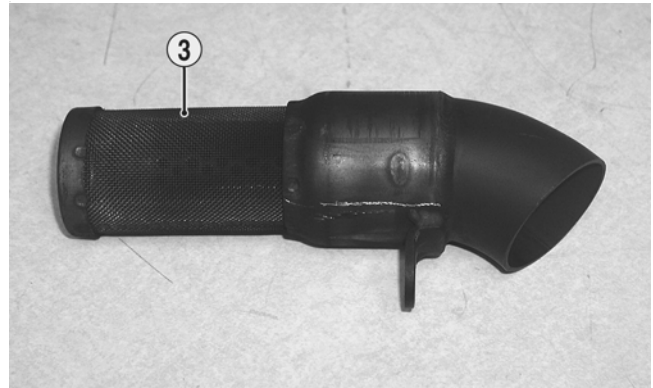

KM140B

3. Install the spark arrester and secure with the cap screw. Tighten securely.

## Engine Oil - Filter

Replace the engine oil and clean the screen/filter at the scheduled intervals. The engine should always be warm when the oil is changed so the oil will drain easily and completely.

1. Park the ATV on level ground.
2. Loosen the oil fill plug.

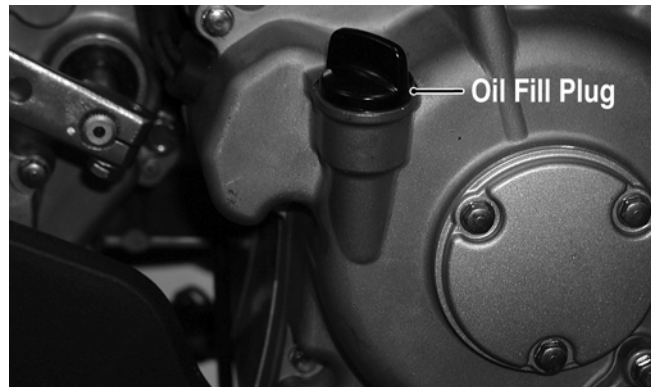

KM126A

3. Remove the screen/filter cap from the bottom of the engine and drain the oil into a drain pan. Account for a spring, O-ring, and screen/filter.

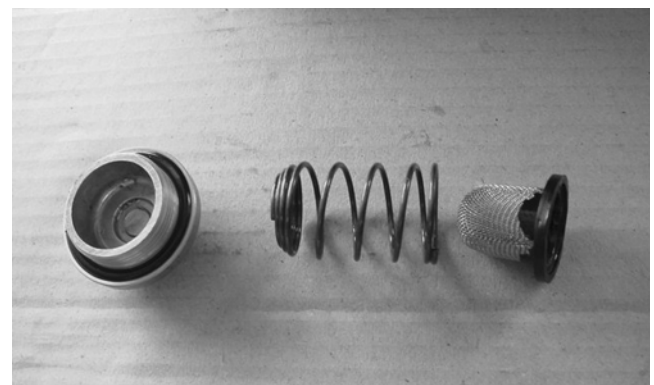

DSC02248

4. Clean the screen/filter in parts-cleaning solvent; then inspect the O-ring and replace if damaged.
5. Install the screen/filter, spring, and screen/filter cap into the crankcase and tighten to 11 ft-lb.
6. Remove the oil fill plug and pour in 1.0 L (1.06 U.S. qt) of the recommended oil into the fill hole; then install the oil fill plug.

**CAUTION**

Any oil used in place of the recommended oil could cause serious engine damage. Do not use oils which contain graphite or molybdenum additives. These oils can adversely affect clutch operation. Also, not recommended are racing, vegetable, non-detergent, and castor-based oils.

7. Start the engine (while the ATV is outside on level ground) and allow it to idle for a few minutes.
8. Turn the engine off and wait approximately one minute. Check the oil level in the engine oil inspection window. The oil level should be visible through the window. If oil is not visible, add recommended oil until the oil level is visible between the lines of the window.

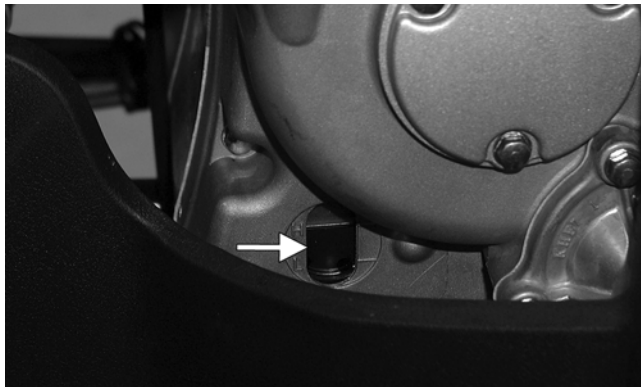

KM127A

9. Inspect the area around the screen/filter cap for leaks.

## Transmission Lubricant

Change the lubricant according to the Periodic Maintenance Chart. When changing the lubricant, use approved SAE 80W-90 hypoid gear lube.

To change the lubricant, use the following procedure.

1. Place the ATV on level ground.
2. Loosen the fill plug; then remove the transmission drain plug and drain the transmission lubricant.

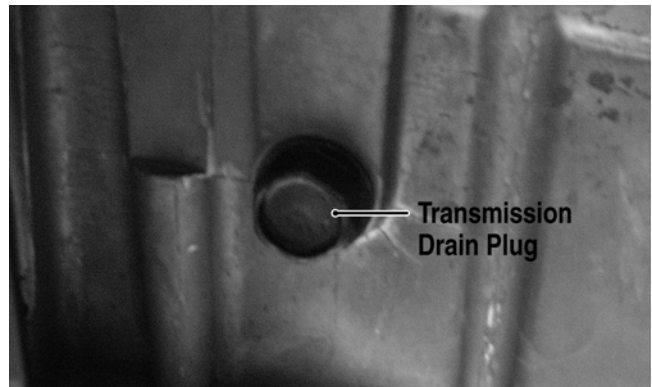

KM851A

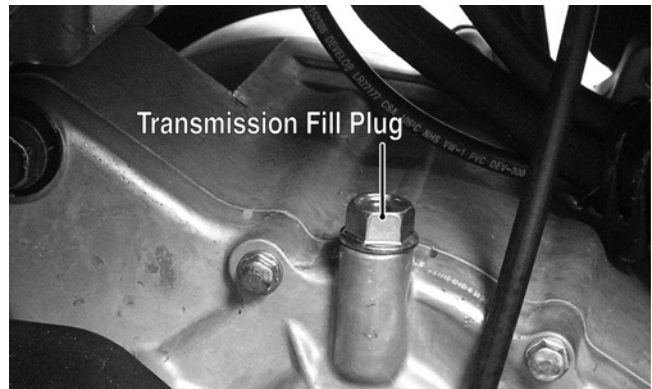

KM845A

3. Install the drain plug and tighten to 21 ft-lb; then remove the transmission level plug and the fill plug.

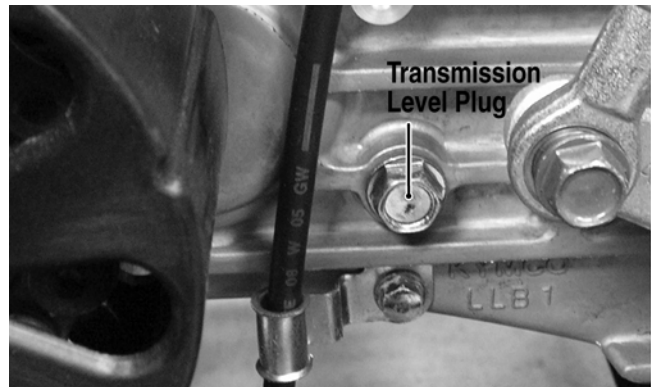

TR028A

4. Pour in the appropriate amount of recommended lubricant into the fill hole while observing the level hole. When correctly filled, transmission lubricant should just be visible on the bottom threads of the level hole.
5. Install the level plug and fill plug and tighten securely; then check for leakage around the drain plug.

## Drive Chain

Drive chain condition and adjustment should be inspected each day before the ATV is operated. Always follow the following guidelines for inspecting and servicing the drive chain.

### **⚠ WARNING**

Failure to inspect and maintain the drive chain can be hazardous. Operating the ATV with the drive chain in poor condition or improperly adjusted can cause an accident resulting in possible injury.

### INSPECTING

Inspect the drive chain for any of the following conditions.

- A. Loose pins.
- B. Loose or cracked rollers.
- C. Dry or rusted links.
- D. Kinked or binding links.
- E. Excessive wear.

The presence of any of the conditions requires drive chain replacement.

■NOTE: If the drive chain is worn or damaged, the sprockets may also be worn or damaged. Inspect the sprockets for worn, broken, or damaged teeth. Always inspect the sprockets when a new drive chain is being installed.

### CLEANING AND LUBRICATING

The drive chain should be cleaned and lubricated frequently to prolong chain and sprocket life. Use the following procedure to clean and lubricate the chain.

■NOTE: This ATV is equipped with an O-ring type roller chain. Each link incorporates small O-rings to seal out water and dirt. Care should be taken to choose cleaning solutions and lubricants that are suitable for O-ring type chains.

1. Using a suitable, nonflammable cleaning solution, thoroughly wash the chain and sprockets.
2. Allow the chain to dry; then apply a dry, graphite-based lubricant to the chain.

■NOTE: The drive chain should be lubricated with a dry, graphite-based chain lubricant. By using a dry, graphite-based chain lubricant, dirt build-up on the drive chain will be minimized.

## ADJUSTING TENSION

1. Loosen the four cap screws (1) on the axle housing; then loosen the nuts (2) on the adjuster bolt.

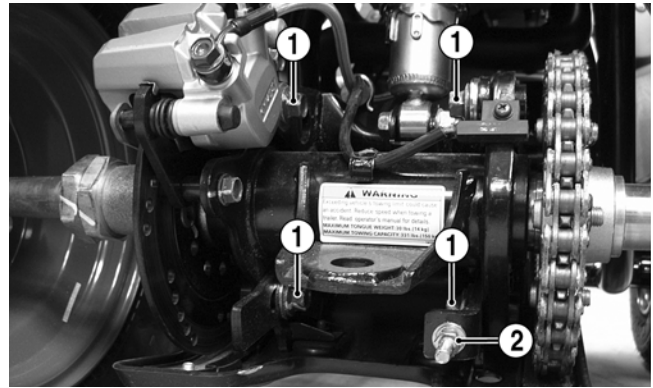

TR018A

2. Adjust the chain slack using the nuts on the adjuster bolt to obtain 10-20 mm movement at the mid-point of the chain.
3. Tighten the four cap screws to 50 ft-lb and the nuts on the adjuster bolt securely.

## Headlight/Taillight-Brakelight

Each time the ATV is used, lights should be checked for proper function. Turn the ignition switch to the LIGHTS position; the headlights and taillight should illuminate. Test the brakelight by compressing the brake lever. The brakelight should illuminate.

### HEADLIGHT

■NOTE: The bulb portion of the headlight is fragile. HANDLE WITH CARE. When replacing the headlight bulb, do not touch the glass portion of the bulb. If the glass is touched, it must be cleaned with a dry cloth before installing. Skin oil residue on the bulb will shorten the life of the bulb.

### **⚠ WARNING**

Do not attempt to remove the bulb when it is hot. Severe burns may result.

To replace the headlight bulb, use the following procedure.

1. Remove the boot from the back of the headlight housing; then remove the three-wire connector from the bulb.
2. Using care not to bend or deform the spring clip, release the two ends of the spring clip from the light housing; then remove the bulb from the headlight housing.

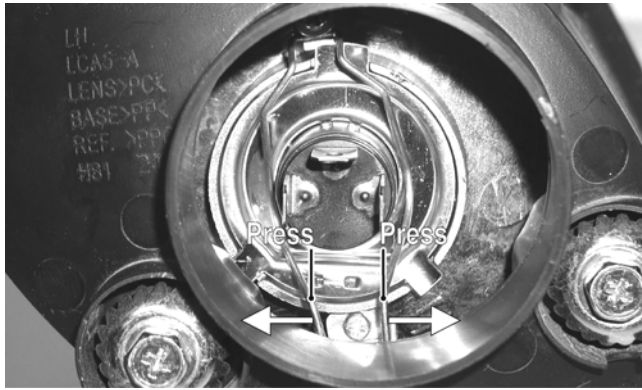

KM192A

3. Install the new bulb into the headlight housing; then secure with the spring clip.
4. Connect the three-wire connector to the bulb; then install the boot.

### TAILLIGHT-BRAKELIGHT

To replace the taillight-brakelight bulb, use the following procedure.

1. Remove the two screws and remove the lens cover.
2. Push the bulb in and turn it counterclockwise.
3. Install the new bulb by turning it clockwise while pushing in.
4. Install the lens cover.

#### CAUTION

Tighten the lens cover screws only until they are snug.

## Shift Lever

### CHECKING ADJUSTMENT



TR222

Stop the ATV completely and shift the transmission into the R position. The reverse gear indicator light should be illuminated.

#### ⚠ WARNING

Never shift the ATV into reverse gear when the ATV is moving as it could cause the ATV to stop suddenly throwing the operator from the ATV.

If the reverse gear indicator light does not illuminate when shifted to the reverse position, the switch may be faulty, the fuse may be blown, the bulb may be faulty, a connection may be loose or corroded, or the lever may need adjusting. To adjust, proceed to Adjusting Shift Lever.

### ADJUSTING SHIFT LEVER

1. Place the shift lever in the N (neutral) position; then set the engine stop switch to the STOP position and turn the ignition switch to the RUN position. The neutral indicator light should illuminate.

2

■NOTE: If the neutral indicator light does not illuminate, adjustment of the shift linkage will be required. To adjust, proceed to step 2.

2. Loosen the jam nuts on both ends of the shift rod and turn the shift rod until the neutral light illuminates. Tighten the jam nuts securely.

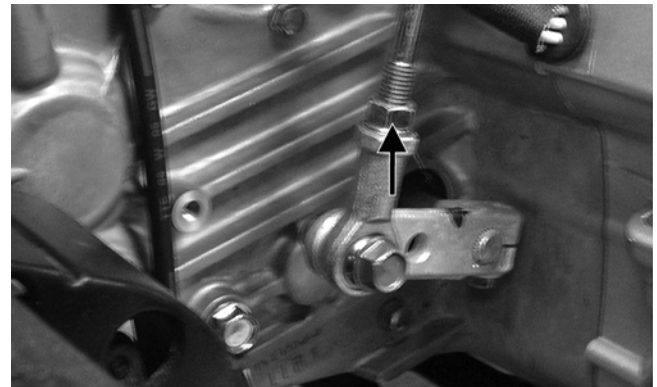

TR037A

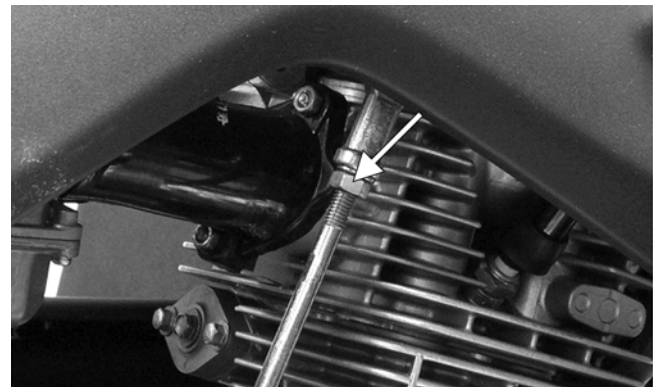

TR038A



## Brake Systems

### ⚠ WARNING

After servicing components that are brake-related, ALWAYS check and adjust brakes as necessary before operating the ATV.

Although the brake systems have been adjusted at the factory, the brakes should be checked for proper operation. The brakes must be maintained to be fully functional.

### CHECKING FRONT WHEEL BRAKE

1. With the engine off, compress the right-hand (front) brake lever and attempt to move the ATV.
2. If the front wheels are locked, it is adjusted properly.
3. If the front wheels are not locked or if only one wheel locks, adjustment is necessary.

### CHECKING REAR WHEEL BRAKE

1. With the engine off, compress the left-hand (rear) brake lever and engage the brake lever lock; then attempt to move the ATV.
2. If the rear wheels are locked, it is serviceable.
3. If the rear wheels are not locked, bleed the brake system or replace the pads as necessary.

### ADJUSTING FRONT WHEEL BRAKE

1. Raise the ATV enough to allow the front wheels to spin freely.
2. Loosen both jam nuts on the right-hand (front) brake lever. Turn both cable adjusters counter-clockwise until both front wheels do not spin freely.

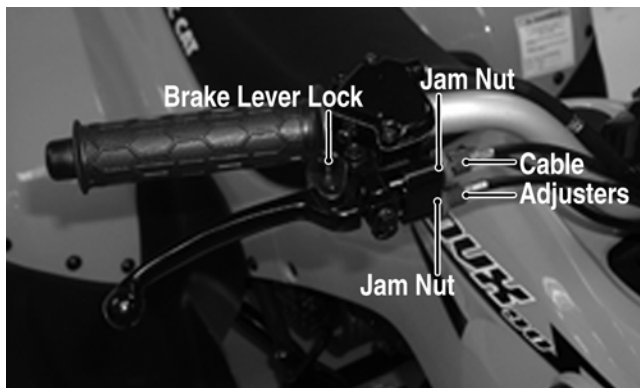

KM024B

3. Turn both cable adjusters in 1/4 turn increments (clockwise) until the wheels spin with a very slight amount of drag.

4. Lower ATV; then push it forward and compress the brake lever.
5. If the front wheels lock evenly, adjustment is correct.
6. If the front wheels do not lock evenly, additional adjustment is necessary.
7. Once proper adjustment is obtained, tighten the jam nuts.

### MEASURING/REPLACING BRAKE SHOES/PADS

#### Removing Front Brake Shoes

1. Support the ATV on a support stand.
2. Remove both front wheels and account for the cap screws.
3. Remove the cotter pins, castle nuts, and washers; then remove the brake drums/wheel hubs.
4. Loosen the brake shoe return spring; then remove the brake shoes.



MD2042

#### Removing Rear Brake Pads

1. Remove the two brake pad alignment pins (A); then remove the mounting cap screws (B).

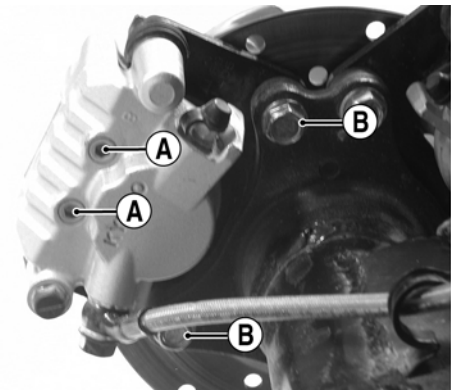

KM273A

2. Remove the caliper from the disc; then compress the caliper holder and remove the brake pads.

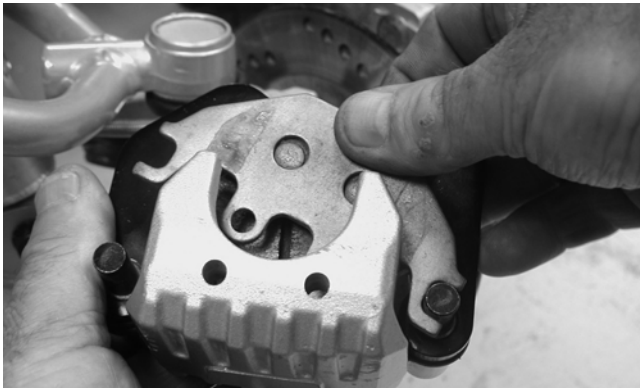

KM267

### Inspecting and Measuring

1. Inspect the pads for gouges, chips, or wear.
2. Inspect the disc for gouges, grooves, cracks, and warpage.
3. Using a calipers, measure the thickness of each brake pad.
4. If the thickness of either brake pad is less than 1.0 mm (0.039 in.), the brake pad must be replaced.

■NOTE: The brake pads should be replaced as a set.

### Installing Front Brake Shoes

1. Place the brake shoes onto the backing plate over the stationary pivot pin and rotating cam.
2. Install the brake return spring.

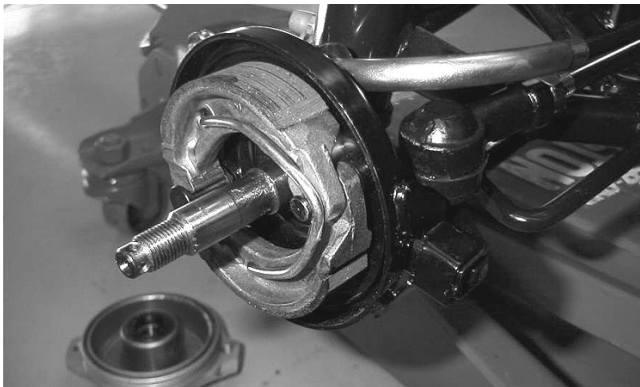

MD2044

3. Install the wheel hub, washer, and castle nut. Tighten the castle nut to 50 ft-lb; then install a new cotter pin.
4. Install the wheel. Tighten to 32 ft-lb.
5. Repeat this procedure for the other side; then adjust the brake (see Adjusting Front Wheel Brake in this sub-section).
6. Remove the ATV from the support stand.

### Installing Rear Brake Pads

1. Install new brake pads; then install the two brake pad alignment pins.
2. Spread the brake pads and place the brake caliper over the disc; then secure with the mounting cap screws (B). Tighten the cap screws to 24 ft-lb; then tighten the alignment pins (A) to 13 ft-lb.

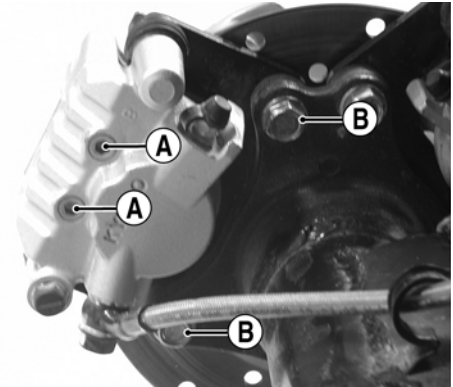

KM273A

■NOTE: Whenever installing new pads, the new pads must be burnished (see Burnishing Brake Pads in this section).

### BLEEDING

1. Remove the brake fluid reservoir cover and fill the reservoir with DOT 4 Brake Fluid.
2. Install and secure the cover.
3. Remove the protective cap from the bleed screw and connect one end of a clear hose to the bleed screw and direct the other end into a suitable container.

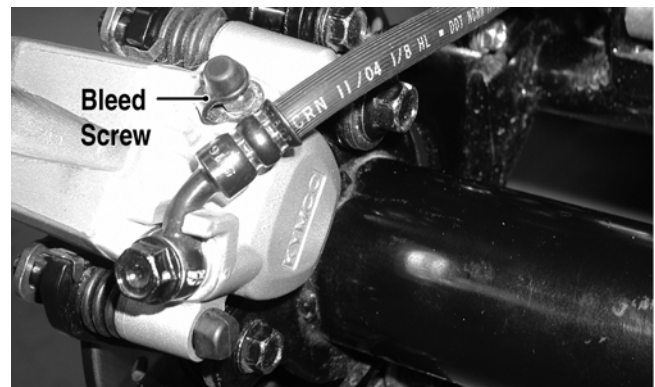

KM207A



AF637D

4. Slowly compress the left brake lever several times; then while holding slight pressure on the brake lever, open the bleed screw and watch for air bubbles in the hose. Close the bleed screw before releasing the brake lever. Repeat this procedure until no air bubbles are present.

■ **NOTE:** During the bleeding procedure, watch the reservoir sight glass to make sure there is always a sufficient amount of brake fluid in the reservoir. Failure to maintain sufficient amount of fluid in the reservoir will result in air being in the system.

5. Repeat step 4 until the brake lever is firm.

---

---

## Burnishing Brake Pads (Rear)

---

Brake pads must be burnished to achieve full braking effectiveness. Braking distance will be extended until brake pads are properly burnished. To properly burnish the brake pads, use the following procedure.

### **WARNING**

Failure to properly burnish the brake pads could lead to premature brake pad wear or brake loss. Brake loss can result in severe injury.

1. Choose an area large enough to safely accelerate the ATV to 30 mph and to brake to a stop.
2. Accelerate to 30 mph; then compress brake lever or apply the auxiliary brake to decelerate to 0-5 mph.
3. Repeat procedure on each brake system five times until brake pads are burnished.
4. Verify that the brakelight illuminates when the hand lever is compressed or the brake pedal is depressed.

---

---

## Checking/Replacing V-Belt

---

### REMOVING

1. Remove the left footwell.

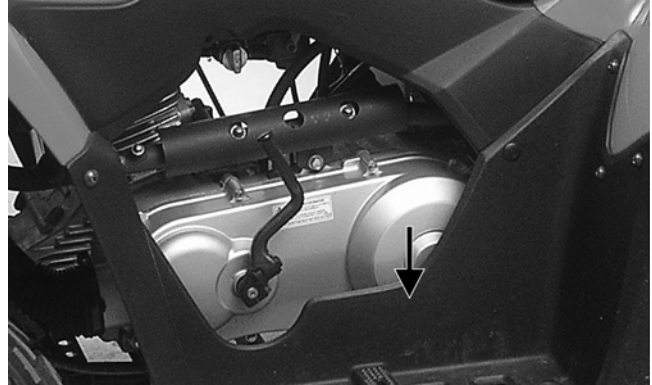

KM885B

2. Remove the front and rear V-belt housing cooling ducts.
3. Remove the cap screws securing the V-belt cover noting the location of the different-lengthed cap screws for installing purposes; then using a rubber mallet, gently tap on the cover tabs to loosen the cover. Remove the cover. Account for two alignment pins and one gasket.



KM253

4. Remove the nut securing the movable drive face; then remove the face. Account for the stepped washer and spacer.



KM276

5. Remove the nut securing the driven pulley; then remove the splined bushing, centrifugal clutch, pulley, and V-belt.

## INSTALLING

1. Using a rubber mallet, spread the driven pulley sheaves by driving the V-belt down between the sheaves; then slide the driven pulley and V-belt into position.



KM262

2. Install the centrifugal clutch housing onto the driven shaft; then install the splined bushing and secure with the driven pulley retaining nut. Tighten to 43 ft-lb.



KM276

3. Install the movable drive face onto the crankshaft making sure to “bottom” the sheave out against the center bushing. The crankshaft splines should be visible and the stepped washer should sit over the splines.

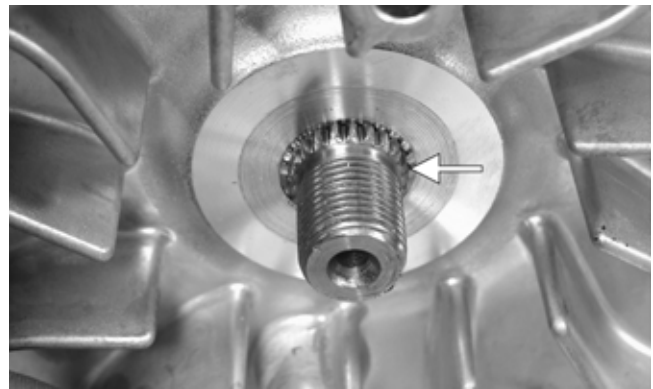

KM263A

### CAUTION

If the splines are not protruding as shown, the V-belt may be too deep in the drive sheaves. This would cause the drive pulley to be under-tightened and severe drive sheave or crankshaft damage could occur.

4. Secure the movable drive face to the crankshaft with the drive pulley nut and tighten to 43 ft-lb.
5. Install the V-belt cover and tighten the cap screws securely; then connect the cooling boots and tighten the clamps securely.
6. Install the footwell assembly. Tighten all hardware securely.

2

# SECTION 3 - ENGINE/TRANSMISSION

---

---

## TABLE OF CONTENTS

---

Engine/Transmission .....	3-2
Specifications .....	3-2
Table of Contents .....	3-3
Troubleshooting .....	3-35

## Engine/Transmission

This section has been organized into sub-sections which show a progression for the complete servicing of the Arctic Cat ATV engine/transmission.

To service the center crankcase halves, the engine/transmission must be removed from the frame.

To service top-side, left-side, and right-side components, the engine/transmission does not have to be removed from the frame.

■NOTE: Arctic Cat recommends the use of new gaskets, lock nuts, and seals and lubricating all internal components when servicing the engine/transmission.

■NOTE: Some photographs and illustrations used in this section are used for clarity purposes only and are not designed to depict actual conditions.

■NOTE: Critical torque specifications are located in Section 1.

### SPECIAL TOOLS

A number of special tools must be available to the technician when performing service procedures in this section. Refer to the current Special Tools Catalog for the appropriate tool description.

Description	p/n
Crankcase Separator/Crankshaft Remover	0444-152
Piston Pin Puller	0644-328
Spanner Wrench	0444-192
Flywheel Holder	0444-193
Magneto Rotor Remover	0444-187
Tappet Adjuster	0444-189
Surface Plate	0644-016
Driven Pulley Compressor	0444-195
V Blocks	0644-022
Ring Compressor	0644-378
Valve Spring Compressor	0444-197
Ball Hone	0644-290
Crankshaft Bearing Puller	0444-194
Blind Bearing Puller Kit	0444-196
Bearing/Seal Driver Kit	0444-190

■NOTE: Special tools are available from the Arctic Cat Service Parts Department.

## Specifications\*

VALVES AND GUIDES		
Valve/Tappet Clearance (cold engine)	(intake/exhaust)	0.06 mm
Valve Guide/Stem Clearance (max)	(intake) (exhaust)	0.06 mm 0.08 mm
Valve Spring Free Length (min)	(intake) (exhaust)	38.2 mm 44.3 mm
Valve Spring Tension @ 33.7 mm	(intake)	7.7-8.9 kg
Valve Spring Tension @ 38.4 mm	(exhaust)	(22.5-38.4 lb)
CAMSHAFT AND CYLINDER HEAD		
Cam Lobe Height (min)	(intake) (exhaust)	31.40 mm 31.13 mm
Rocker Arm/Shaft Clearance	(max)	0.1 mm
Cylinder Head/Cover Distortion	(max)	0.05 mm
CYLINDER, PISTON, AND RINGS		
Piston Skirt/Cylinder Clearance	(max)	0.1 mm
Cylinder Bore		62.030-62.045 mm
Piston Diameter 18 mm from Skirt End	(min)	61.9 mm
Bore x Stroke		62 x 49.5 mm
Cylinder Trueness	(max)	0.05 mm
Piston Ring to Groove Clearance (max)	(1st/2nd)	0.09 mm
Piston Ring End Gap - Installed (min)	(top) (middle) (oil)	0.10 mm 0.10 mm 0.20 mm
Piston Pin Bore	(max)	15.04 mm
Piston Pin Outside Diameter	(min)	14.96 mm
CRANKSHAFT		
Connecting Rod (small end inside diameter)	(max)	15.06 mm
Connecting Rod (big end side-to-side)	(max)	0.55 mm
Crankshaft Runout	(max)	0.1 mm
Oil Pressure at 60°C (140°F) @ 3000 RPM	(above) (below)	0.3 kg/cm <sup>2</sup> (4.3 psi) 0.7 kg/cm <sup>2</sup> (10 psi)
TRANSMISSION		
Clutch Wheel Inside Diameter	(max)	130.5 mm
Centrifugal Clutch Shoe Lining Thickness		2.0 mm
Clutch Engagement RPM		3250
Clutch Lock-Up RPM		4700
Movable Drive Face Bushing I.D.	(max)	27.06 mm
Drive Face Collar	(min)	26.94 mm
Drive Belt Width	(min)	19.0 mm
Drive Pulley Weight Rollers	(min)	20.42 mm
Movable Driven Face Spring Free Length	(min)	83.20 mm
Fixed Driven Face Hub O.D.	(min)	33.94 mm
Movable Driven Face Bushing I.D.	(max)	34.06 mm

\* Specifications subject to change without notice.

## Table of Contents

Removing Engine/Transmission .....	3-3
Top-Side Components.....	3-5
Removing Top-Side Components .....	3-6
Servicing Top-Side Components.....	3-7
Installing Top-Side Components .....	3-12
Left-Side Components .....	3-13
Removing Left-Side Components .....	3-14
Servicing Left-Side Components .....	3-15
Installing Left-Side Components .....	3-19
Right-Side Components.....	3-20
Removing Right-Side Components.....	3-20
Servicing Right-Side Components.....	3-22
Installing Right-Side Components.....	3-23
Disassembling Crankcase Half .....	3-26
Servicing Center Crankcase Components.....	3-28
Assembling Crankcase Half .....	3-30
Installing Engine/Transmission .....	3-32

## Removing Engine/Transmission

Many service procedures can be performed without removing the engine/transmission from the frame. Closely observe the note introducing each sub-section for this important information.

### AT THIS POINT

If the technician's objective is to service/replace left-side cover oil seals, the engine/transmission does not have to be removed from the frame.

Secure the ATV on a support stand to elevate the wheels.

### WARNING

Make sure the ATV is solidly supported on the support stand to avoid injury.

1. Remove the seat; then remove the left and right side covers and footwells.
2. Remove the gas tank (see Section 4).
3. Move the battery cover and disconnect the negative battery cable.



TR022A

4. Remove the crankcase breather hose from the crankcase ventilator valve; then loosen the intake boot clamp and remove the air filter assembly.

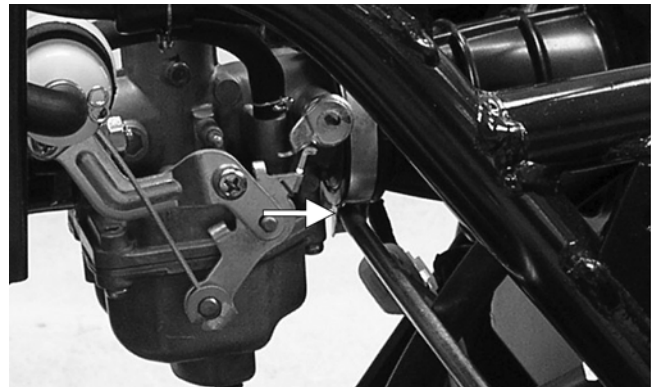

TR050A

5. Remove the nuts securing the intake to the cylinder head; then remove the intake pipe/carburetor assembly leaving the throttle cable and choke cable connected. Set the assembly aside.

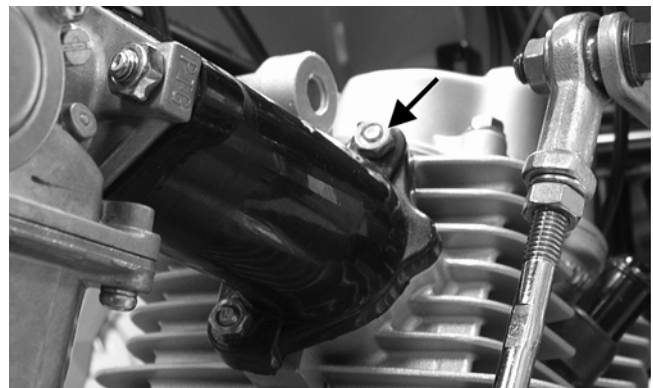

TR054A

6. From the right side, remove the spark plug cap and starter lead; then disconnect the shift rod from the lower shift arm.

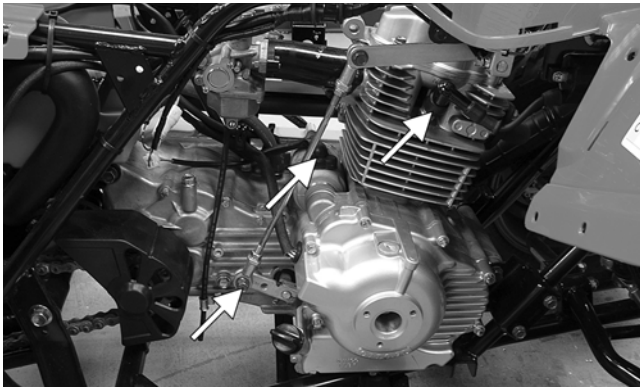

TR059A

7. Disconnect the AC generator plug; then mark the location of the cable tie and remove the tie.



TR061

9. Disconnect the signal coil, trigger coil, and gear shift position switch connectors.

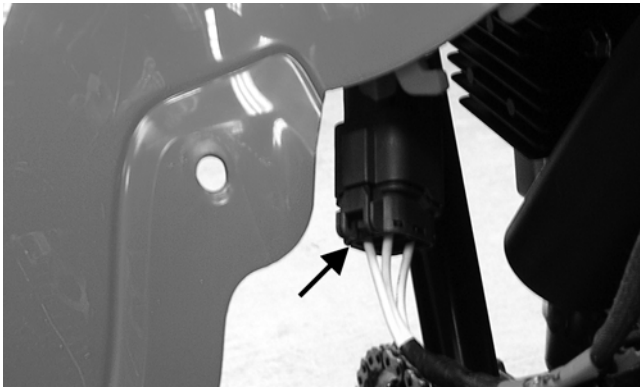

TR071A

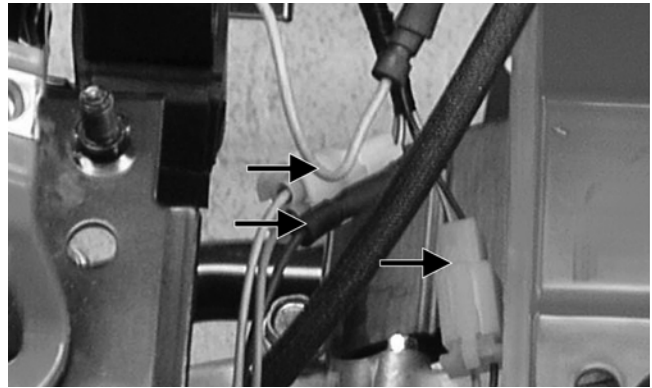

TR070A

10. Remove the two nuts and two cap screws securing the exhaust pipe/muffler assembly and remove the exhaust assembly. Account for the exhaust flange and two sealing wedges.

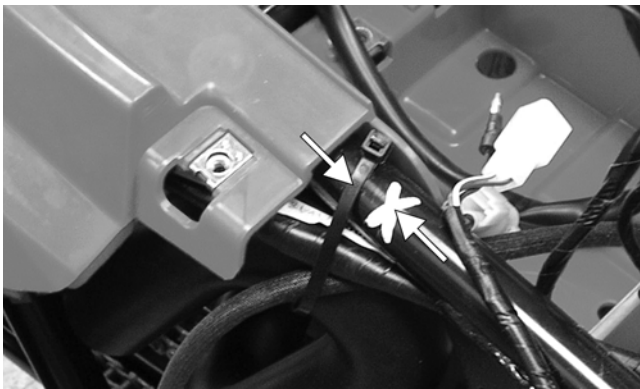

TR072A

8. From the left side, remove the CVT cooling duct clamps; then remove the cooling ducts.

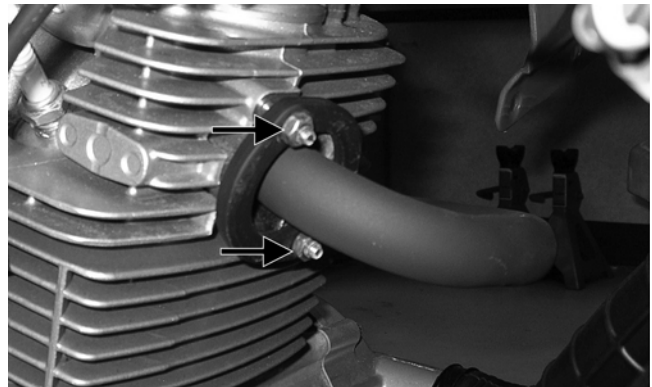

TR067A

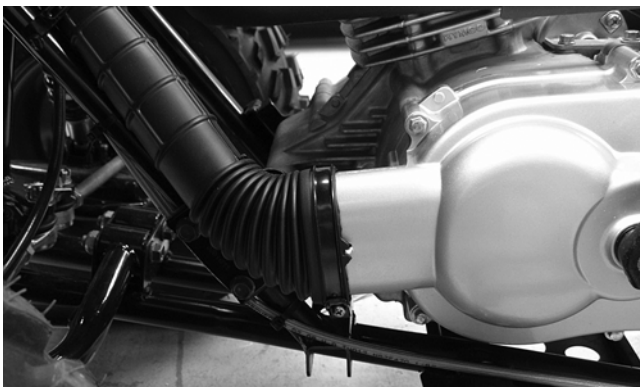

TR063

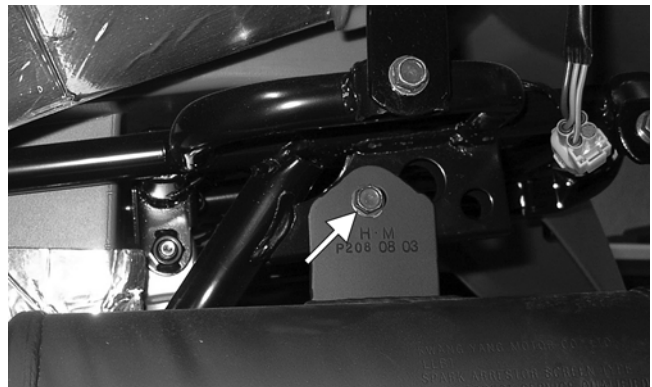

TR073A



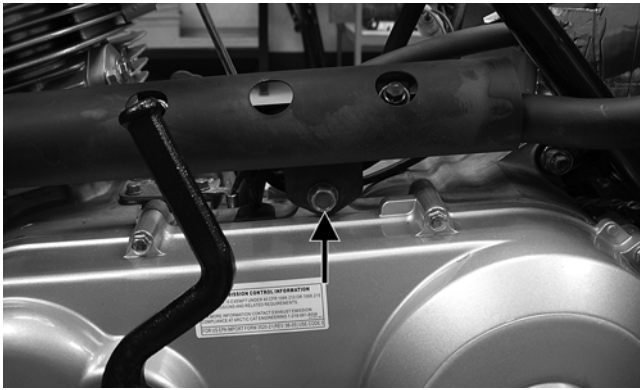

TR062A

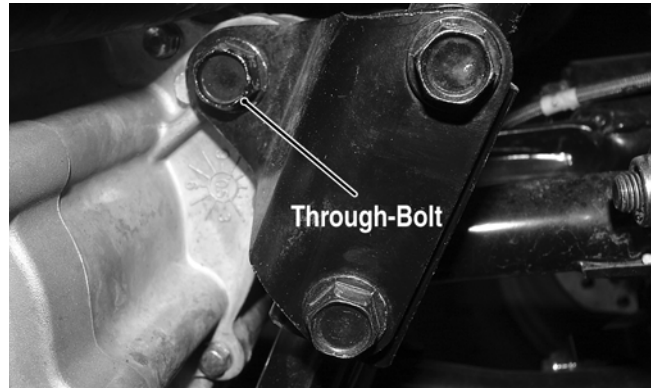

KM414A

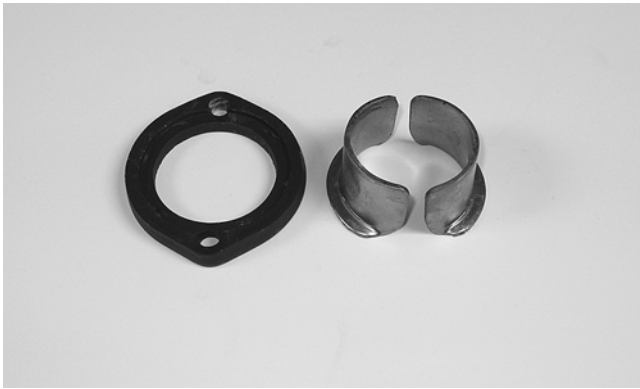

TR041

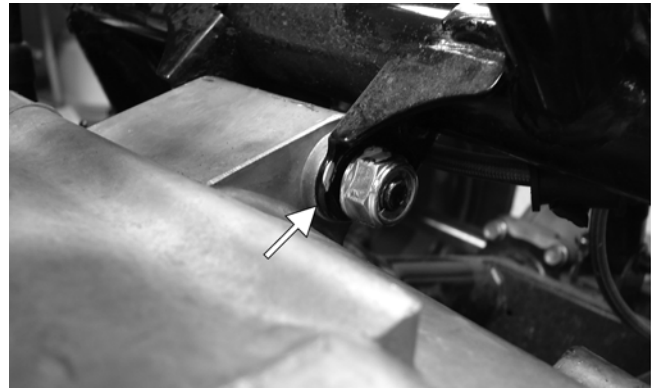

KM333A

11. Remove the drive sprocket guard; then remove the two cap screws and retainer securing the drive sprocket to the driveshaft. Remove the drive sprocket.

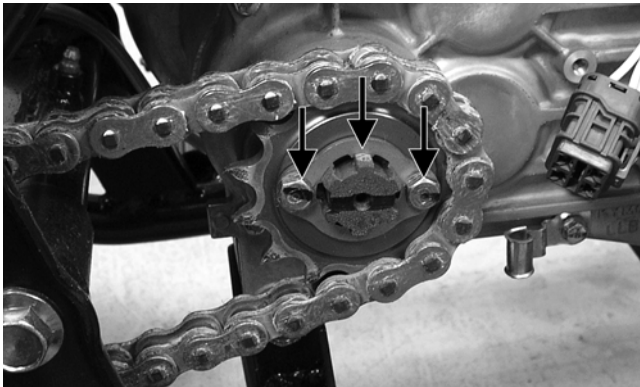

TR075A

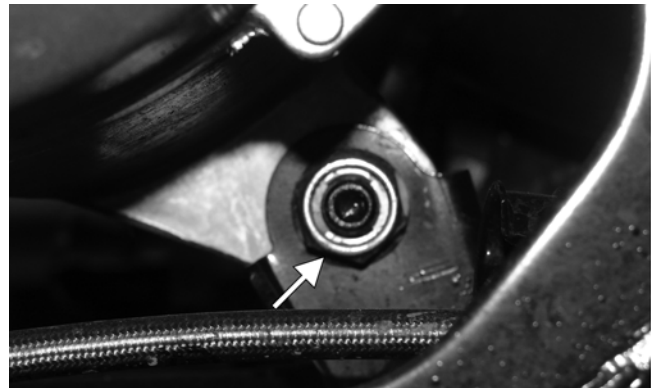

KM325A

13. Remove the engine/transmission assembly from the frame tilting the rear of the assembly upwards and lifting out the left side.

■NOTE: It may be necessary to loosen the drive chain to remove the sprocket (see Drive Chain in Section 2).

12. Remove the three through bolts securing the engine to the frame; then remove the left front mounting bracket from the frame.

## Top-Side Components

■NOTE: For efficiency, it is preferable to remove and disassemble only those components which need to be addressed and to service only those components. The technician should use discretion and sound judgment.

### 👉 AT THIS POINT

To service any one specific component, only limited disassembly of components may be necessary. Note the AT THIS POINT information in each sub-section.

■NOTE: The engine/transmission does not have to be removed from the frame for this procedure.

## Removing Top-Side Components

- A. Valve Cover
- B. Cylinder Head

■NOTE: Remove the spark plug and timing inspection plug; then rotate the crankshaft to top-dead-center of the compression stroke.

1. Remove the cap screws securing the cylinder head cover. Account for the O-ring.



KM703

■NOTE: Keep the mounting hardware with the cover for assembly purposes.

2. Remove the plug from the cam chain tensioner; then turn the cam chain tensioner screw clockwise to release the chain tension.

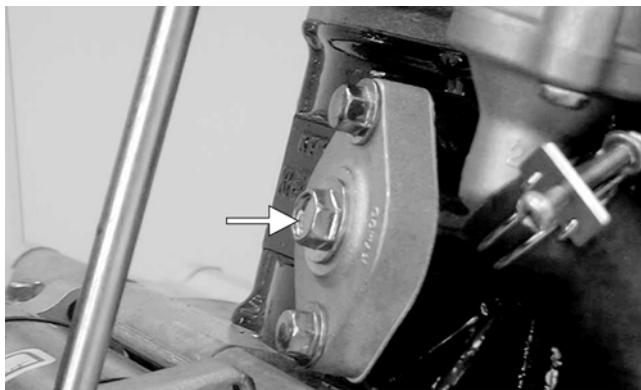

KM704A

3. Using a crisscross pattern, loosen the four nuts securing the camshaft holder to the cylinder head. Use 2-3 steps until the nuts are all free; then remove the camshaft holder. Account for four washers and two alignment pins.

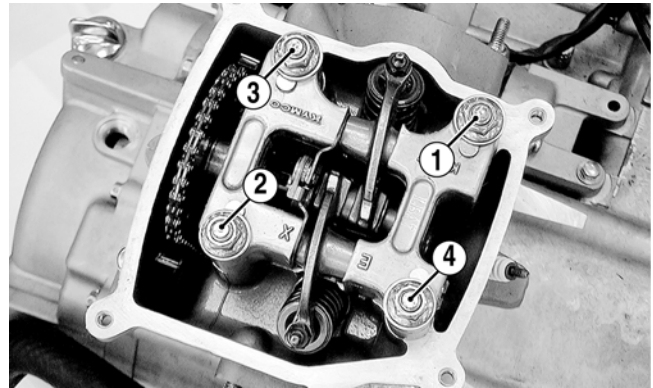

KM706A

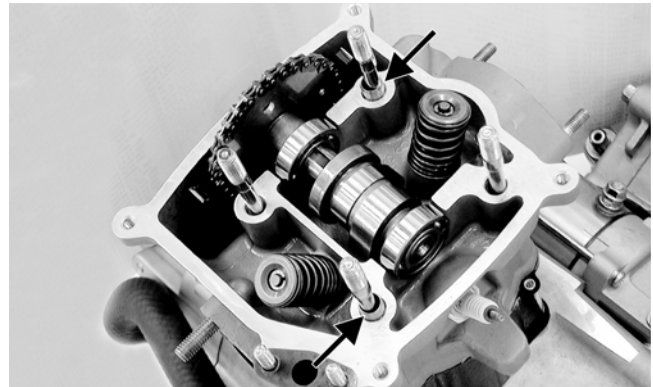

KM707A

4. Remove the camshaft gear from the cam chain; then secure the timing chain so it will not fall into the engine. Remove the camshaft.
5. Remove the two cap screws securing the cylinder head to the cylinder; then remove the cylinder head. Account for two alignment pins and a cylinder head gasket.

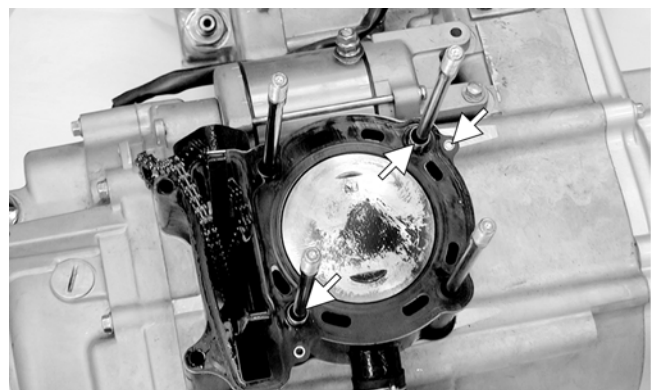

KM718A

6. Remove the cam chain guide; then remove the cylinder. Support the piston with rubber bands or other suitable supports. Account for two dowel pins and the cylinder gasket.

### 👉 AT THIS POINT

To service valves and cylinder head, see Servicing Top-Side Components sub-section.

### 👉 AT THIS POINT

To inspect cam chain guide, see Servicing Top-Side Components sub-section.

**C. Cylinder**  
**D. Piston**

■NOTE: Steps 1-6 in the preceding sub-section must precede this procedure.

**AT THIS POINT**  
To service cylinder, see Servicing Top-Side Components sub-section.

**CAUTION**  
When removing the cylinder, be sure to support the piston to prevent damage to the crankcase and piston.

- Using a needle nose pliers, remove one piston pin circlip. Take care not to drop it into the crankcase.



KM451

- Using Piston Pin Puller, remove the piston pin. Account for the opposite-side circlip. Remove the piston.

■NOTE: It is advisable to remove the opposite-side circlip prior to using the puller.

■NOTE: Support the connecting rod with rubber bands to avoid damaging the rod or install a connecting rod holder.

**CAUTION**  
Do not allow the connecting rod to go down inside the crankcase. If the rod is down inside the crankcase and the crankshaft is rotated, severe damage will result.

■NOTE: If the existing rings will not be replaced with new rings, note the location of each ring for proper installation. When replacing with new rings, replace as a complete set only. If the piston rings must be removed, remove them in this sequence.

- Starting with the top ring, slide one end of the ring out of the ring-groove.

- Remove each ring by working it toward the dome of the piston while rotating it out of the groove.

**AT THIS POINT**  
To service piston, see Servicing Top-Side Components sub-section.

**AT THIS POINT**  
To service center crankcase components only, proceed to Removing Left-Side Components.

## Servicing Top-Side Components

■NOTE: Whenever a part is worn excessively, cracked, or damaged in any way, replacement is necessary.

### VALVE ASSEMBLY

When servicing valve assembly, inspect valve seats, valve stems, valve faces, and valve stem ends for pits, discoloration, or other signs of abnormal wear.

■NOTE: Whenever a valve is out of tolerance, it must be replaced.

### Cleaning/Inspecting Camshaft Holder

- Remove the rocker arm shafts, rocker arms, and stop plate from the camshaft holder.

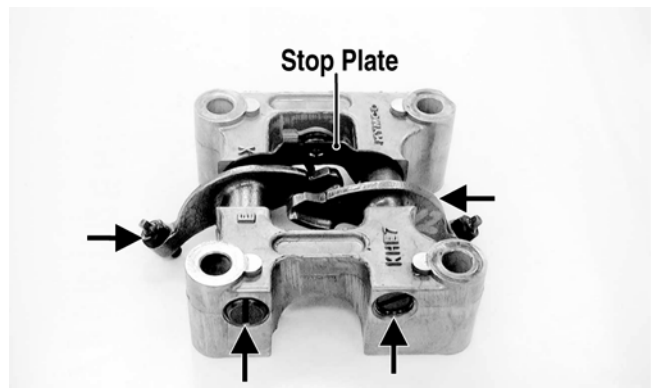

KM708A

- Inspect the camshaft holder for cracks, distortion, or galling.
- Inspect the rocker arm shafts for blue discoloration or scoring.
- Inspect the rocker arms for excessive wear, loose adjusters, or scored camshaft followers.

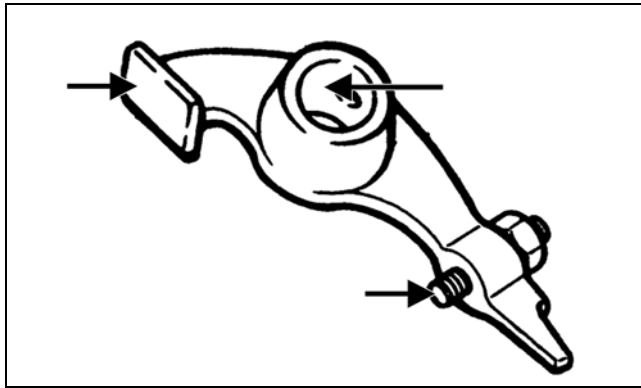

KM710A

## Removing Valves

■NOTE: Keep all valves and valve components as a set. Note the original location of each valve set for use during installation. Return each valve set to its original location during installation.

1. Using a valve spring compressor, compress the valve springs and remove the valve cotters. Account for an upper spring retainer.

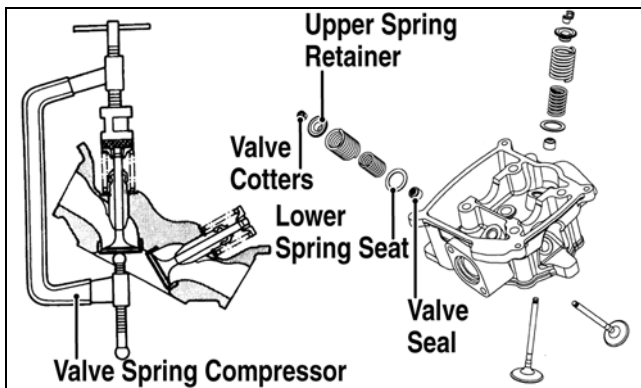

KM717A

2. Remove the valve seal, valve springs, and the lower remaining spring seat. Discard the valve seal.

■NOTE: The valve seals must be replaced.

3. Invert the cylinder head and remove the valves.

## Measuring Valve Stem/ Valve Guide Clearance

1. Using a micrometer, measure the valve stem outside diameter; then using a suitable snap gauge and micrometer, measure the valve guide inside diameter
2. Acceptable clearance must be within specifications.

## Inspecting Valve Face

Inspect the valve face for pitting, grooving, or discoloration. Replace any valve that is damaged.

## CYLINDER HEAD ASSEMBLY

■NOTE: If the cylinder head cannot be trued, it must be replaced.

## Cleaning/Inspecting Cylinder Head

1. Using a non-metallic carbon removal tool, remove any carbon build-up from the combustion chamber making sure not to nick, scrape, or damage the combustion chamber or the sealing surface.
2. Inspect the spark plug hole for any damaged threads. Repair damaged threads using a "heli-coil" insert.
3. Place the cylinder head on the surface plate covered with #400 grit wet-or-dry sandpaper. Using light pressure, move the cylinder head in a figure eight motion. Inspect the sealing surface for any indication of high spots. A high spot can be noted by a bright metallic finish. Correct any high spots before assembly by continuing to move the cylinder head in a figure eight motion until a uniform bright metallic finish is attained.

### CAUTION

Water or parts-cleaning solvent must be used in conjunction with the wet-or-dry sandpaper or damage to the sealing surface may result.

## Measuring Cylinder Head Distortion

1. Remove any carbon buildup in the combustion chamber.
2. Lay a straightedge across the cylinder head; then using a feeler gauge, check the distortion factor between the head and the straightedge.
3. Maximum distortion must not exceed specifications.



CC141D

## Measuring Camshaft Lobe Height

1. Using a calipers, measure each cam lobe height.

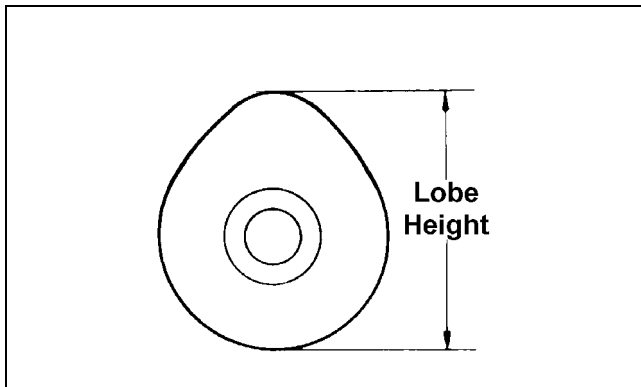

ATV1013A

- The lobe heights must not be less than minimum specifications.

### Inspecting Camshaft Bearing Journal

- Inspect the bearing journal for scoring, seizure marks, or pitting.
- If excessive scoring, seizure marks, or pitting is found, the cylinder head assembly must be replaced.

### Measuring Rocker Arm/ Shaft Clearance

- Using a dial calipers, measure the inside diameter of the rocker arm; then measure the outside diameter of the rocker arm shaft.
- Acceptable clearance must not exceed specifications.

### Installing Valves

- Apply grease to the inside surface of the valve seals; then place a lower spring seat and valve guide seal over each valve guide.
- Insert each valve into its original valve location.
- Install the valve springs with the closest coils toward the cylinder head.

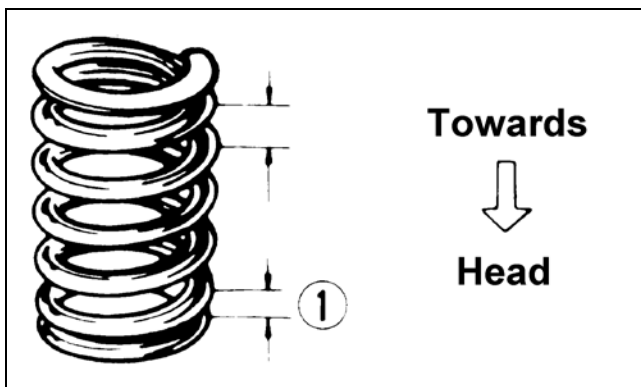

ATV-1011A

- Place a spring retainer over the valve springs; then using the valve spring compressor, compress the valve springs and install the valve cotters.

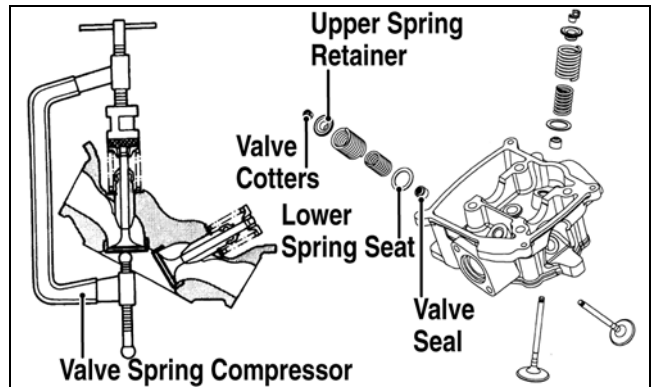

KM717A

### PISTON ASSEMBLY

■NOTE: Whenever a piston, rings, or pin are out of tolerance, they must be replaced.

### Cleaning/Inspecting Piston

- Using a non-metallic carbon removal tool, remove any carbon buildup from the dome of the piston.
- Inspect the piston for cracks in the piston pin, dome, and skirt areas.
- Inspect the piston for seizure marks or scuffing. Repair with #400 grit wet-or-dry sandpaper and water or honing oil.

■NOTE: If scuffing or seizure marks are too deep to correct with the sandpaper, replace the piston.

- Inspect the perimeter of each piston for signs of excessive "blowby." Excessive "blowby" indicates worn piston rings or an out-of-round cylinder.

### Removing Piston Rings

- Starting with the top ring, slide one end of the ring out of the ring-groove.



CC400D

- Remove each ring by working it toward the dome of the piston while rotating it out of the groove.

■NOTE: If the existing rings will not be replaced with new ones, note the location of each ring for proper installation. When installing new rings, install as a complete set only.

3

## Cleaning/Inspecting Piston Ring Grooves

1. Take an old piston ring and snap it into two pieces; then grind the end of the old ring to a 45° angle and to a sharp edge.
2. Using the sharpened ring as a tool, clean carbon from the ring-grooves.

### CAUTION

Improper cleaning of the ring-grooves by the use of the wrong type of ring-groove cleaner will result in severe damage to the piston.

## Measuring Piston-Ring End Gap (Installed)

1. Place each piston ring in the wear portion of the cylinder. Use the piston to position each ring squarely in the cylinder.
2. Using a feeler gauge, measure each piston-ring end gap. Acceptable ring end gap must not exceed specifications.

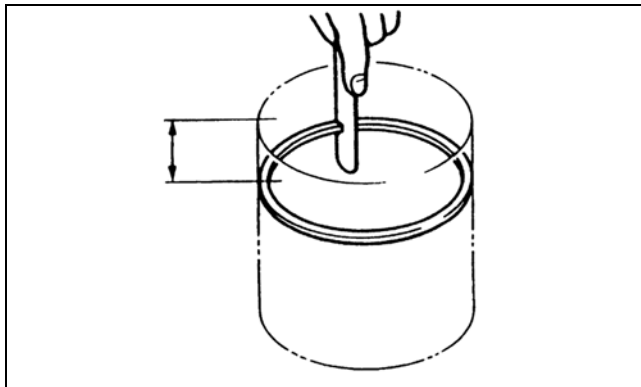

KM452

## Measuring Piston Pin (Outside Diameter) and Piston-Pin Bore

1. Measure the piston pin outside diameter at each end and in the center. If measurement is not within specifications, the piston pin must be replaced.

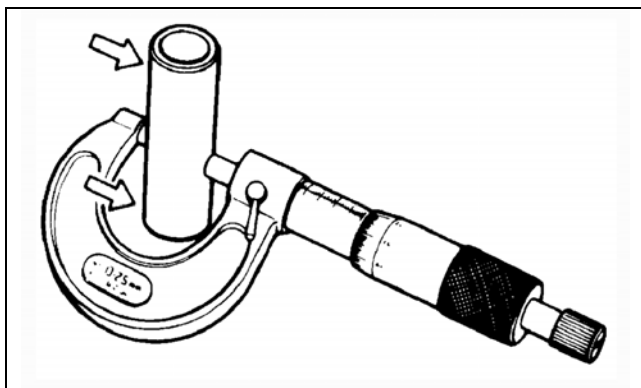

ATV-1070

2. Inspect and measure the connecting rod small end. If the measurement exceeds specifications, the connecting rod must be replaced (see Servicing Center Crankcase Components in this section).
3. Insert an inside dial indicator into the piston-pin bore. The diameter must not exceed specifications. Take two measurements to ensure accuracy.

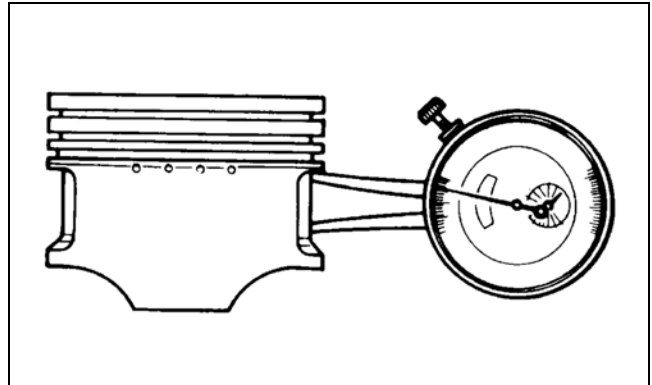

ATV-1069

## Measuring Piston Skirt/ Cylinder Clearance

1. Measure the cylinder front to back in six places.

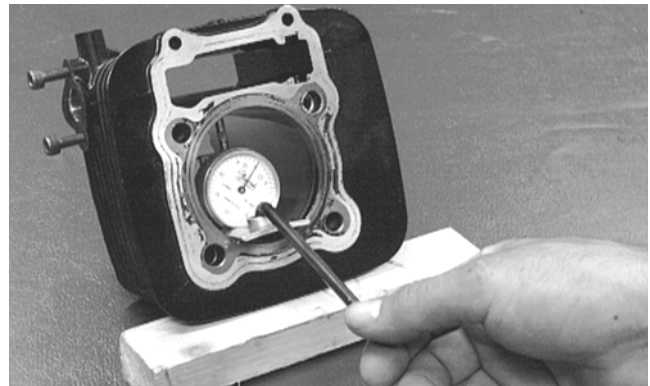

CC397D

2. Measure the corresponding piston diameter at a point 18 mm above the piston skirt at a right angle to the piston-pin bore. Subtract this measurement from the measurement in step 1. The difference (clearance) must be within specifications.

## Installing Piston Rings

1. Install ring expander (4) in the bottom groove of the piston; then install the thin oil rings (3) over the expander making sure the expander ends do not overlap. Stagger the end gaps of the upper and lower thin oil rings according to the illustration.

■NOTE: Note the direction of the exhaust side of the piston (5) for correct ring end gap orientation.

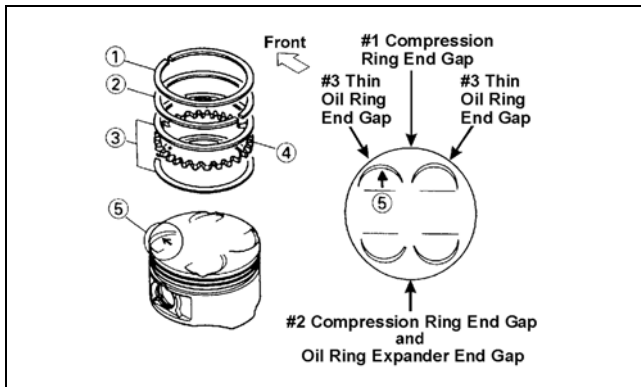

ATV-1085B

2. Install the compression rings (1 and 2) so the letter on the top surface of each ring faces the dome of the piston. Rotate the rings until the ring end gaps are on directly opposite sides of the piston according to the illustration.

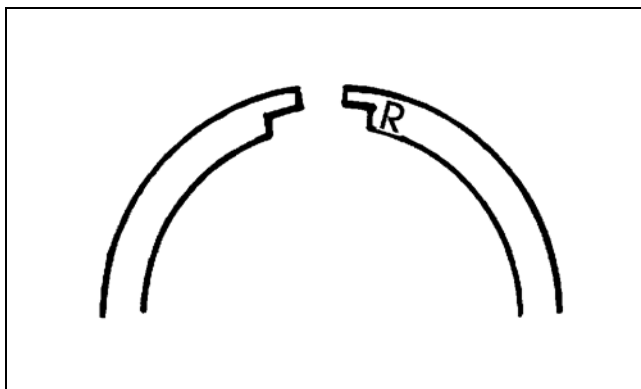

726-306A

### CAUTION

Incorrect installation of the piston rings will result in engine damage.

## CYLINDER ASSEMBLY

■NOTE: If the cylinder cannot be trued, it must be replaced.

### Cleaning/Inspecting Cylinder

1. Wash the cylinder in parts-cleaning solvent.
2. Inspect the cylinder for pitting, scoring, scuffing, warpage, and corrosion. If marks are found, repair the surface using a cylinder hone (see Honing Cylinder in this sub-section).

3. Place the cylinder on the surface plate covered with #400 grit wet-or-dry sandpaper. Using light pressure, move the cylinder in a figure eight motion. Inspect the sealing surface for any indication of high spots. A high spot can be noted by a bright metallic finish. Correct any high spots before assembly by continuing to move the cylinder in a figure eight motion until a uniform bright metallic finish is attained.

### CAUTION

Water or parts-cleaning solvent must be used in conjunction with the wet-or-dry sandpaper or damage to the sealing surface may result.

### Inspecting Cam Chain Guide

1. Inspect cam chain guide for cuts, tears, breaks, or chips.
2. If the chain guide is damaged, it must be replaced.

### Honing Cylinder

1. Using a slide gauge and a dial indicator or a snap gauge, measure the cylinder bore diameter in three locations from top to bottom and again from top to bottom at 90° from the first measurements for a total of six measurements. The trueness (out-of-roundness) is the difference between the highest and lowest reading. Maximum trueness (out-of-roundness) must not exceed specifications.

3

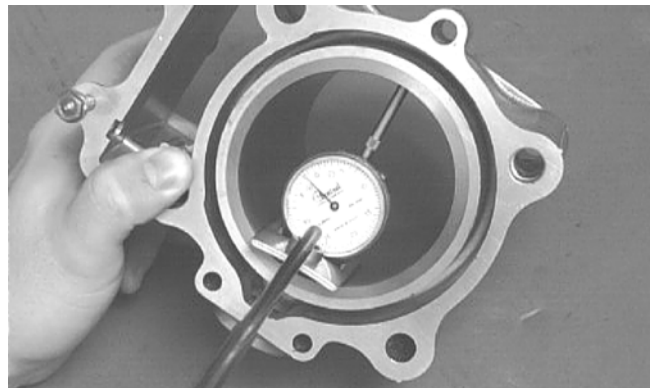

CC127D

2. Wash the cylinder in parts-cleaning solvent.
3. Inspect the cylinder for pitting, scoring, scuffing, and corrosion. If marks are found, repair the surface using a #320 grit ball hone.

■NOTE: To produce the proper 60° cross-hatch pattern, use a low RPM drill (600 RPM) at the rate of 30 strokes per minute. If honing oil is not available, use a lightweight petroleum-based oil. Thoroughly clean cylinder after honing using soap and hot water. Dry with compressed air; then immediately apply oil to the cylinder bore. If the bore is severely damaged or gouged, replace the cylinder.

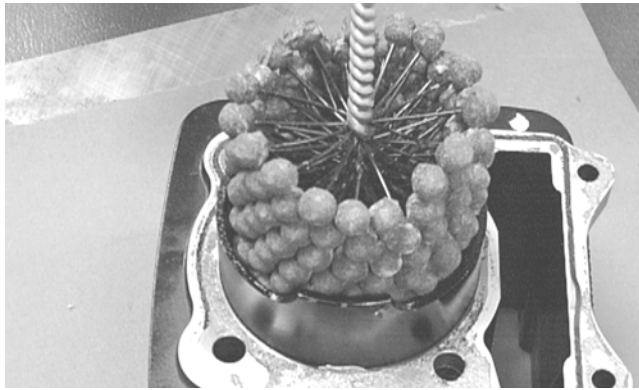

CC390D

4. If any measurement exceeds the limit, replace the cylinder.

## Installing Top-Side Components

### A. Piston

### B. Cylinder

1. Install the piston on the connecting rod making sure there is a circlip on each side and the open end of the circlip is directed upwards or downwards.

■NOTE: The piston should be installed so the IN mark is toward the intake (rear) side of the cylinder.

2. Place the two alignment pins into position. Place the cylinder gasket into position; then place a piston holder (or suitable substitute) beneath the piston skirt and square the piston in respect to the crankcase.
3. Lubricate the inside wall of the cylinder; then using a ring compressor or the fingers, compress the rings and slide the cylinder over the piston. Route the cam chain up through the cylinder cam chain housing; then remove the piston holder and seat the cylinder firmly on the crankcase.

### CAUTION

The cylinder should slide on easily. Do not force the cylinder or damage to the piston, rings, cylinder, or crankshaft assembly may occur.

4. Turn the cam chain tensioner screw clockwise to retract the tensioner spring.

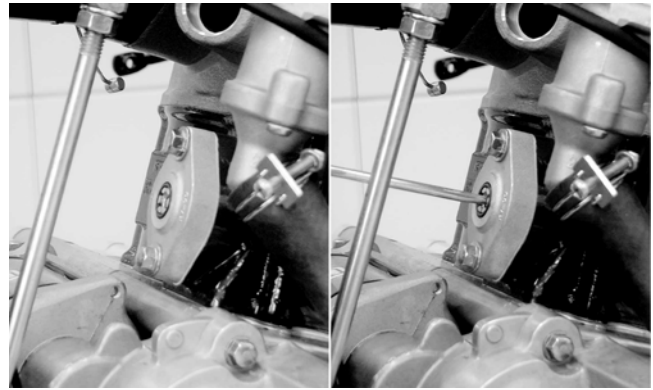

KM705

### C. Cylinder Head

### D. Valve Cover

■NOTE: Steps 1-4 in the preceding sub-section must precede this procedure.

5. While keeping tension on the cam chain, place the front cam chain guide into the cylinder.

### CAUTION

Care should be taken that the bottom of the chain guide is secured in the crankcase boss.

6. Place the head gasket into position on the cylinder. Place the alignment pins into position; then place the head assembly into position on the cylinder making sure the cam chain is routed through the chain cavity.

### CAUTION

Keep tension on the cam chain to avoid damaging the crankcase boss.

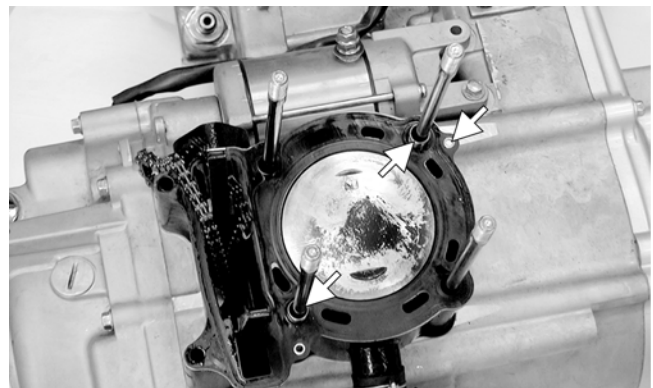

KM718A

7. Turn the crankshaft as required to align the "T" mark on the rotor/flywheel with the index mark on the right-side crankcase cover.





TR043A

8. With the index hole in the camshaft gear directed away from the cylinder head and the two punch marks aligned with the cylinder head surface, install the timing gear into the cam chain and seat the camshaft into the camshaft journals.

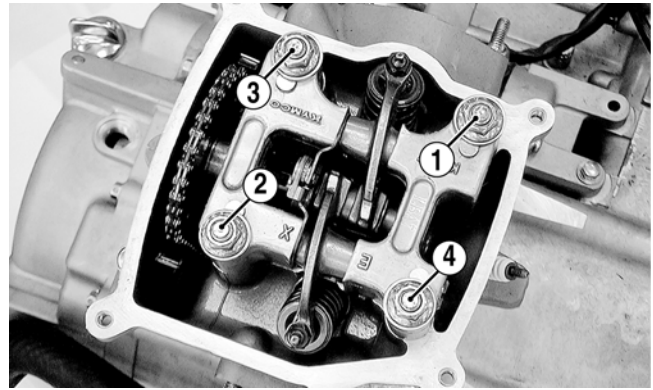

KM706A

10. Install the cam chain tensioner assembly and tighten the mounting cap screws to 9 ft-lb; then turn the tensioner screw counterclockwise to tension the cam chain.

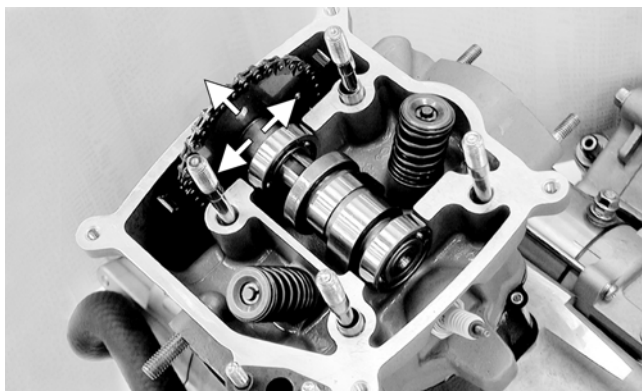

KM715A

9. Install the two alignment pins; then install the camshaft holder and secure with the four cylinder head nuts and washer. Using a crisscross pattern, tighten to 14 ft-lb.

■NOTE: Threads must be clean with fresh engine oil applied to ensure correct torque.

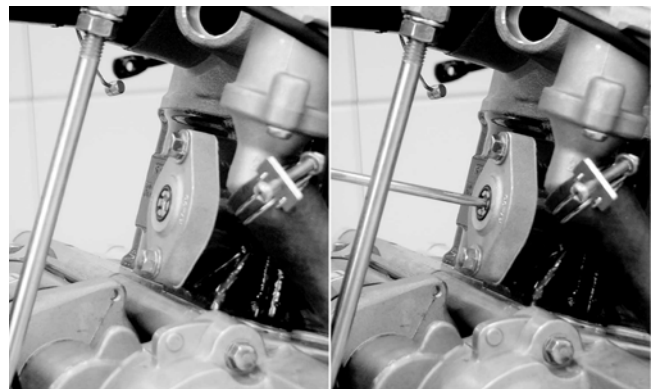

KM705

11. Install the cam chain tensioner cover bolt and tighten to 36 in.-lb.

12. Check that the cam gear alignment marks are correctly oriented; then install and tighten the internal cylinder head to cylinder cap screws to 7 ft-lb.

13. Install the cylinder head cover with a new O-ring and tighten securely.

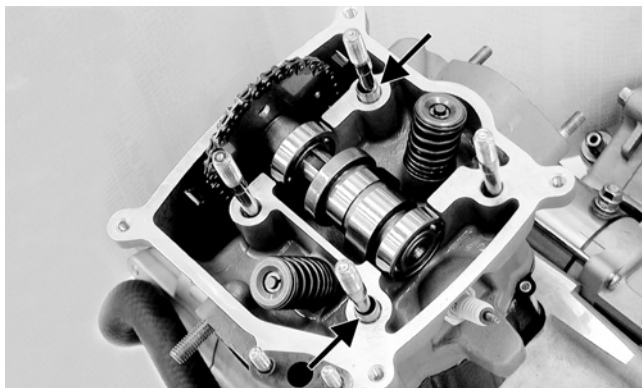

KM707A

3

## Left-Side Components

■NOTE: For efficiency, it is preferable to remove and disassemble only those components which need to be addressed and to service only those components. The technician should use discretion and sound judgment.

### 👉 AT THIS POINT

To service any one specific component, only limited disassembly of components may be necessary. Note the AT THIS POINT information in each sub-section.

■NOTE: The engine/transmission does not have to be removed from the frame for this procedure.

---

---

## Removing Left-Side Components

---

---

- A. Kick Starter**
- B. V-Belt Cover**
- C. Drive Pulley**
- D. Driven Pulley/Centrifugal Clutch Assembly**

1. Mark and remove the kick starter lever.



2. Remove the cap screws securing the V-belt cover; then remove the cover noting the location of the two dowel pins. Note the condition of the V-belt cover gasket. Replace if damaged.

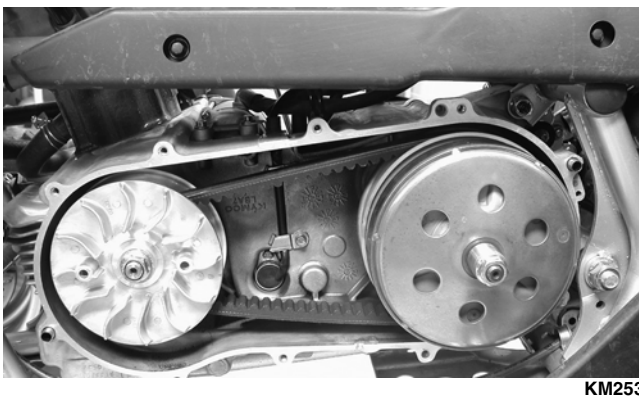

3. Using a suitable holder to prevent the drive pulley from turning, remove the drive pulley nut and starter ratchet; then remove the drive pulley face.



4. Hold the centrifugal clutch with a suitable holder; then remove the clutch retaining nut and clutch collar.



5. Remove the outer clutch housing; then remove the centrifugal clutch, driven pulley, and V-belt.



6. Remove the wire guides securing the switch harness; then remove the gear shift position switch. Account for an O-ring.

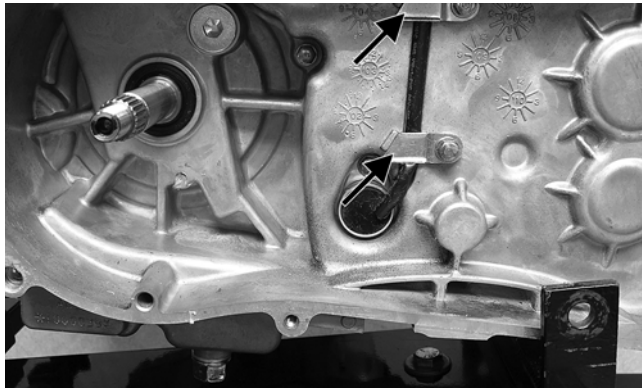

TR087A

■NOTE: It is very important to note the position of the roll pin on the gear shift position switch for assembly purposes. The switch can be installed with the pin 180° from correct position. The indicator lights will not illuminate.

## Servicing Left-Side Components

### KICK STARTER

■NOTE: The kick starter is a non-serviceable component. If parts are worn excessively, the CVT cover assembly must be replaced.

### V-BELT COVER

1. Inspect the bearing for excessive wear, rough or binding when turning, seal condition, and secure mounting in the V-belt cover.

■NOTE: If the bearing is worn excessively, turns roughly, or bearing seals are loose, the bearings must be replaced.



KM254

2. Inspect the V-belt cover for cracks, distortion, and loose alignment pins.

■NOTE: If the V-belt cover is cracked or distorted or if the bearing is loose in the cover, the cover must be replaced.

### DRIVE PULLEY

1. Remove the ramp plate from the movable drive face; then inspect the ramp plate guides and weight roller for damage or excessive wear.



KM256

2. Inspect the face surfaces of the fixed and movable drive faces for grooving, nicks, or discoloration.



KM394A

3. Inspect the drive pulley collar for wear or damage. Measure the outside diameter of the drive pulley collar sliding surface. The minimum service limit is 26.94 mm.



KM389

3

## DRIVEN PULLEY/CENTRIFUGAL CLUTCH ASSEMBLY

### Disassembling

#### **WARNING**

This procedure involves relaxing a compressed spring assembly. **DO NOT** attempt disassembling without the proper tools.

1. Place the driven pulley on a suitable spring compressor; then mark the pulley faces and centrifugal clutch for alignment during assembling.

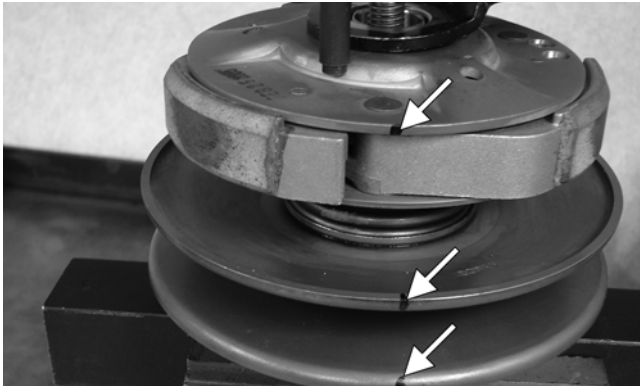

KM374A

2. Secure the centrifugal clutch with the spring compressor; then remove the drive plate nut.

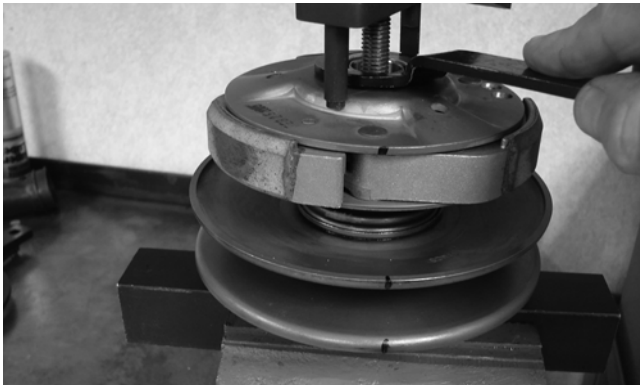

KM373

3. Release the spring pressure and remove the centrifugal clutch assembly from the driven pulley.



KM375

4. Remove the spring and spring seat; then remove the hub collar.



KM385

5. Remove four pins and bushings from the fixed face hub; then remove the movable face.



KM384



KM380

### Inspecting

1. Inspect the pulley faces for wear, galling, or grooving.



KM394A

2. Inspect the O-rings on the movable face for nicks, tears, or swelling.

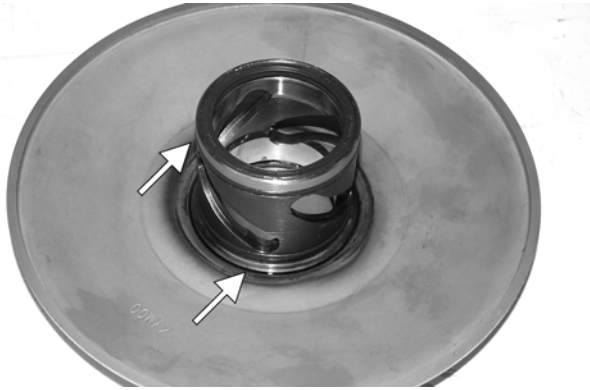

KM380A

3. Inspect two grease seals in the movable face for nicks, cuts, or damage.



KM380B

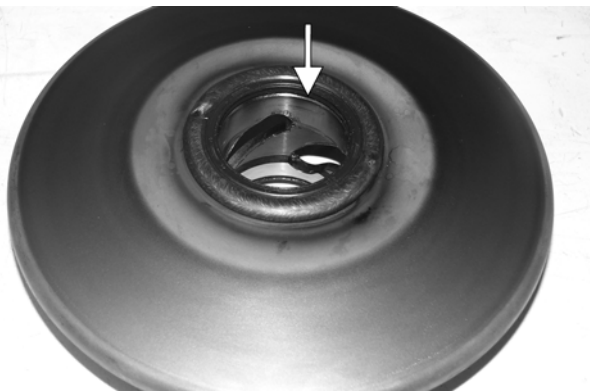

KM382A

4. Inspect the pins and bushings for wear, flat spots, looseness, or cracking; then measure the inside diameter of the movable driven face bushing. Maximum allowable service limit is 34.06 mm



KM379

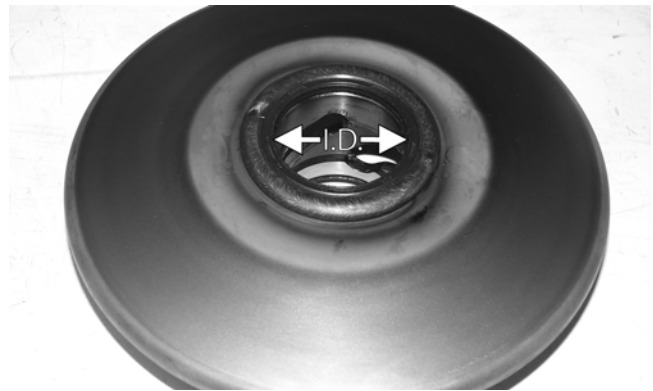

KM382B

5. Measure the driven face spring free length. If the free length is less than 83.20 mm, the spring must be replaced.

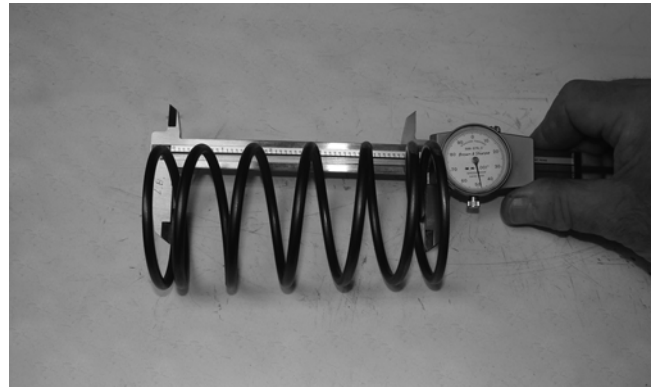

KM376

6. Measure the fixed driven face hub outside diameter using a calipers. The minimum service limit is 33.94 mm.



KM378

3

7. Measure the thickness of the centrifugal clutch shoe lining. The minimum service limit for the lining is 2.0 mm.

■NOTE: If any shoe lining is below the service limit, the complete set must be replaced.

### Assembling

1. Place the fixed face of the driven pulley on the pulley compressor base.

■NOTE: Make sure the spacer is on the base or damage to the fixed face will occur when the spring is compressed.

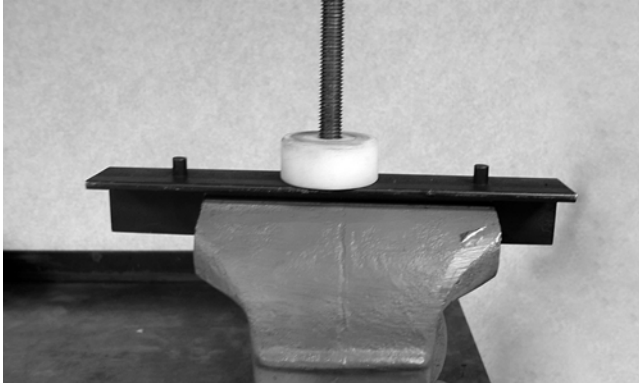

KX571

2. Apply multi-purpose grease to the O-rings and grease seals on the movable face; then install on the fixed face making sure the alignment marks are properly aligned.

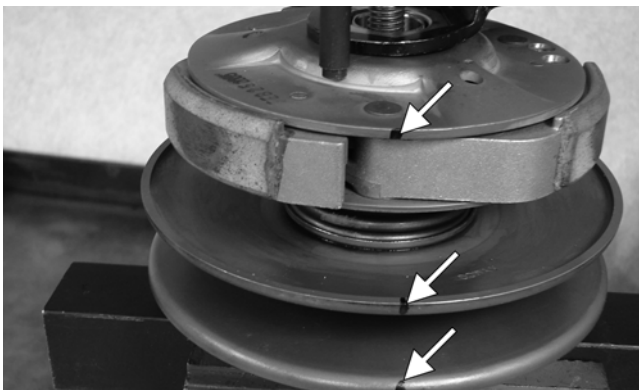

KM374A

3. Install the pins and spacers into the fixed face hub; then pack the cam slots in the movable face with multi-purpose grease.



KM384

4. Install the spring seat over the hub and movable face hub.



KM385

5. Place the spring holder on the spring; then install the spring on the pulley assembly.



KM386

6. Place the centrifugal clutch assembly, drive plate nut, and clutch compressor adapter in position; then using the clutch compressor wing nut, compress the clutch spring and install the nut (lightly coated with red Loctite #271).

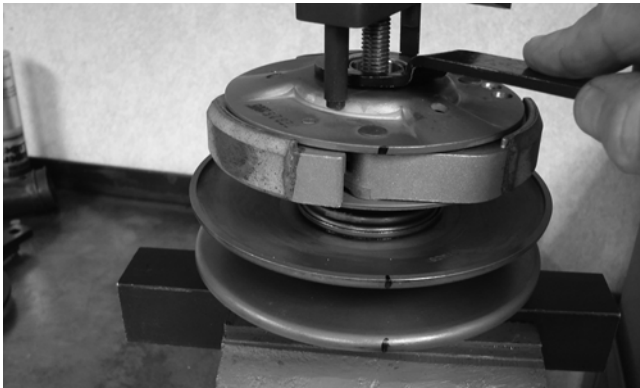

KM373

- Using a suitable holding fixture, tighten the drive plate nut to 43 ft-lb.

## Installing Left-Side Components

- Drive Pulley
- Driven Pulley/Centrifugal Clutch Assembly
- V-Belt Cover

### AT THIS POINT

If the gear shift position switch was removed, install it into the crankcase using a new O-ring. Tighten the cap screw securely.

### CAUTION

Make sure to orient the roll-pin with the longer end directed to the rear. Failure to properly orient the switch will result in failure of the neutral and reverse lights to illuminate.



TR088

- Install the movable drive face and drive pulley collar on the crankshaft.
- Open the faces of the driven pulley; then insert a suitable wedge between the faces to hold them apart.

- Place the V-belt around the pulley and push the belt down between the pulley faces; then install the driven pulley/centrifugal clutch assembly onto the driveshaft. Loop the V-belt over the drive pulley collar.



KM262



KM369

- Place the fixed drive face into position on the crankshaft and engage the splines making sure the splines extend beyond the pulley face hub.

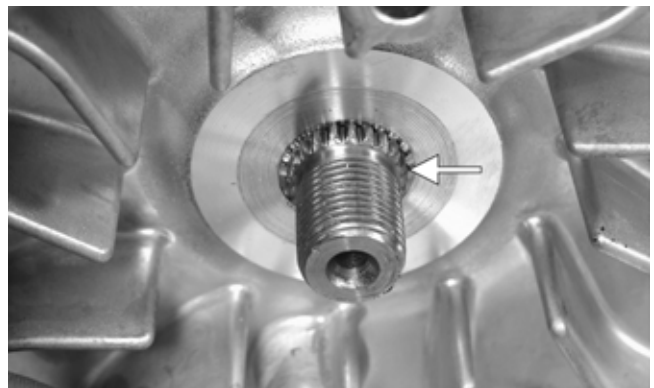

KM263A

- Install the starter ratchet on the crankshaft making sure to engage the splines; then secure with the drive pulley nut and tighten to 43 ft-lb.

3



KM365

6. Install the centrifugal clutch housing and clutch collar; then secure with the flange nut (coated with red Loctite #271) and tighten to 40 ft-lb.



KM253

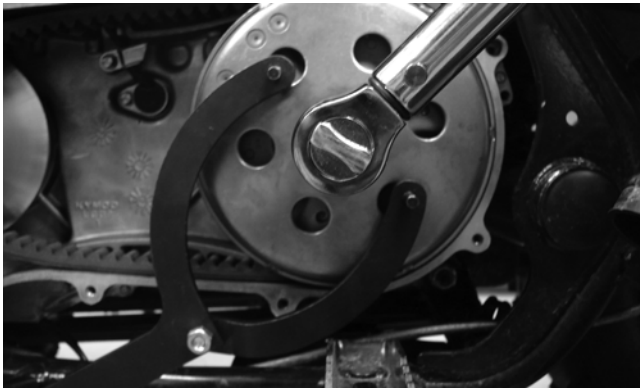

KM368

7. Install the alignment pins and a new gasket on the crankcase; then install the CVT cover and secure with the cap screws. Tighten to 7 ft-lb.

## Right-Side Components

### AT THIS POINT

To service center crankcase components only, proceed to Removing Right-Side Components.

NOTE: For efficiency, it is preferable to remove and disassemble only those components which need to be addressed and to service only those components. The technician should use discretion and sound judgment.

### AT THIS POINT

To service any one specific component, only limited disassembly of components may be necessary. Note the AT THIS POINT information in each sub-section.

NOTE: The engine/transmission does not have to be removed from the frame for this procedure.

## Removing Right-Side Components

- A. Rotor/Flywheel
- B. Stator Coil/Signal Coil
- C. Trigger Coil
- D. Starter One-Way Clutch
- E. Starter Gears
- F. Oil Pump/Oil Pump Drive
- G. Countershaft Drive Gear
- H. Crankshaft Gear

1. Remove the magneto cover noting the location of one short cap screw. Account for a gasket, oil through, and two alignment pins.

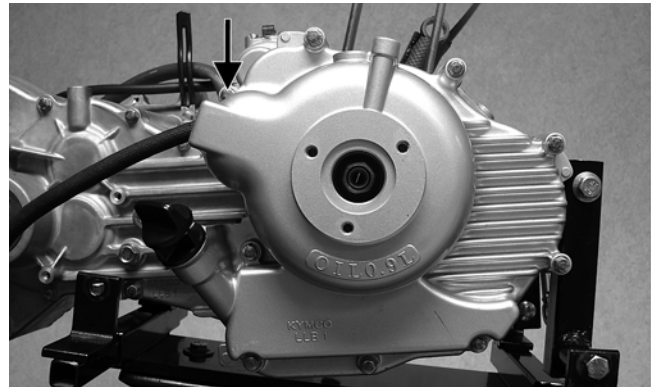

TR089A

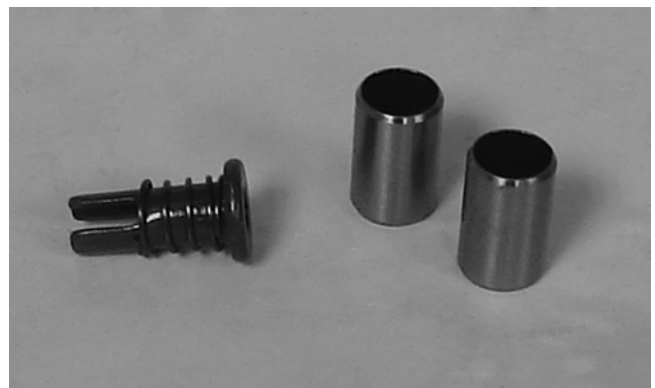

TR150



2. Remove the rotor/flywheel nut. Account for a flat washer.
3. Using the appropriate rotor/flywheel puller, remove the rotor/flywheel. Account for the key.

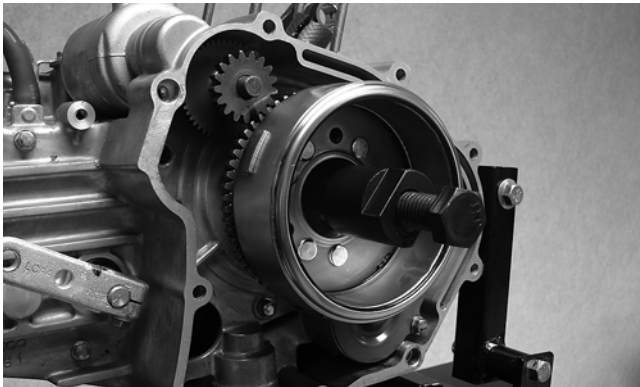

TR090

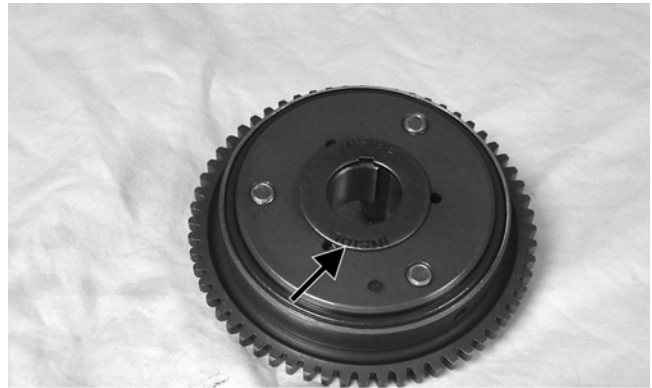

TR167A

4. Using a spanner wrench or appropriate socket, remove the nut (left-hand thread) securing the starter gear and starter one-way clutch assembly to the crankshaft. Account for stepped washer noting that the word INSIDE is directed toward the clutch assembly.

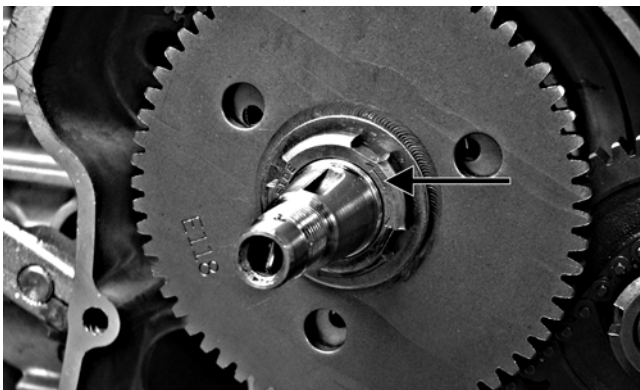

TR191A



TR096

6. Remove the starter countershaft gears; then remove the countershaft.
7. Remove the balancer shaft drive gear nut (left-hand thread). Account for a stepped washer with the stepped side directed toward the drive gear.



TR144



TR094

5. Remove the starter gear/starter one-way clutch assembly. Account for a key and stepped washer noting that the word INSIDE is directed toward the crankcase and the washer has a keyway.

8. Remove the oil pump driven gear nut; then remove the oil pump drive gear, drive chain, and driven gear. Account for a key and spacer.

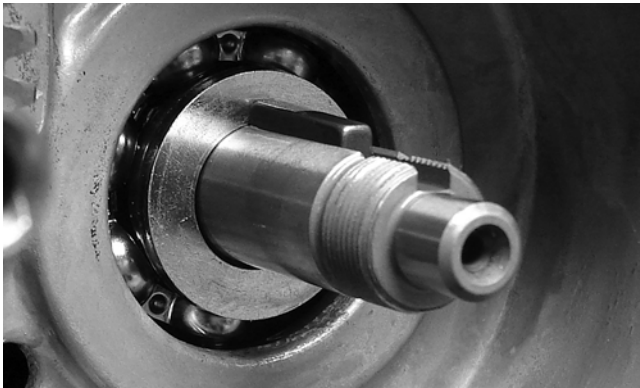

TR095

9. Remove the two oil pump mounting cap screws; then remove the oil pump assembly noting the directional arrow.



TR104

10. Remove the crankshaft drive gear. Account for a key.



TR100

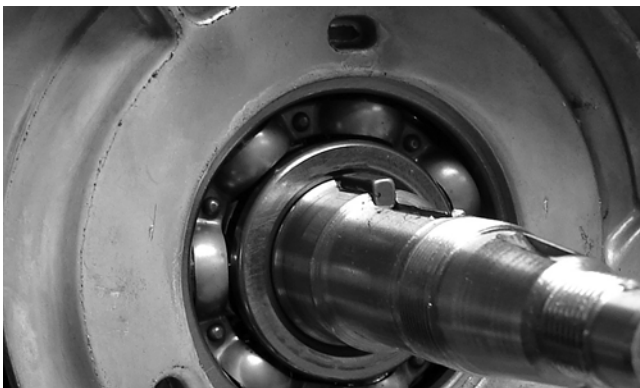

TR099

■NOTE: The crankshaft gear is not a press-fit gear and can be removed by hand.

## Servicing Right-Side Components

### INSPECTING

1. Inspect wires, wire routing, and gromets in the magneto cover.

■NOTE: Magneto components may be serviced if required (see Section 5).

2. Inspect starter gears, starter one-way clutch, and starter countershaft and gears. Confirm that starter one-way clutch only turns one direction.

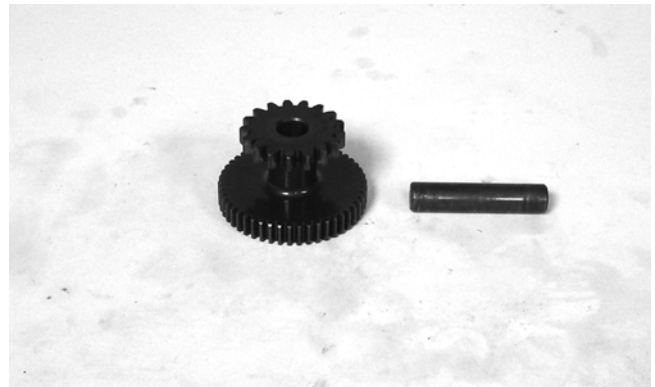

TR154

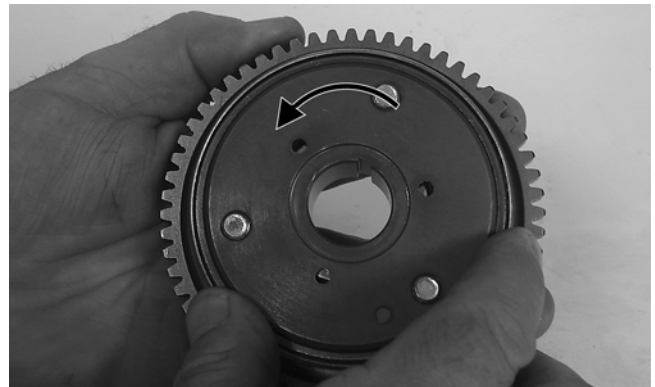

TR149A

3. Check all keys for signs of shearing or chaffing.
4. Inspect the oil pump drive sprockets, chain, and oil pump assembly for excessive wear, discoloration, or oil pump binding internally.



TR170

5. Inspect the crankshaft drive gear, balancer shaft drive gear, and keyways for wear, chipping, or discoloration.



TR168

6. Look for any signs of metal particles on the rotor/flywheel which might indicate internal parts failure.



TR147A

7. Inspect the rotor/flywheel for cracks, loose rivets, or worn keyway.

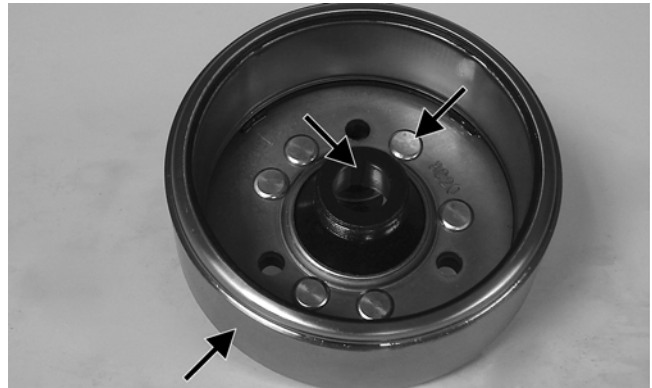

TR146A

## Installing Right-Side Components

■NOTE: When assembling components, always use new gaskets, O-rings, and seals. Coat all moving parts with fresh, clean motor oil.

3

1. Install the oil pump assembly into the crankcase making sure the arrow is directed upward; then secure with the two cap screws and tighten to 7 ft-lb.



TR104A



TR182

2. Install a square key into the crankshaft; then install the crankshaft drive gear onto the crankshaft.



TR183



TR184

3. Install a spacer and square key on the balancer shaft; then align the timing mark on the balancer driven gear to the timing mark on the drive gear and slide the driven gear into place.



TR185



TR186

4. Install the oil pump drive gear, chain, and driven gear as an assembly; then apply red Loctite #271 to the oil pump shaft and secure with oil pump driven gear nut. Tighten to 7 ft-lb.



TR188

5. Install the washer with the word INSIDE toward the gear; then apply red Loctite #271 to the threads and install the balancer nut (left-hand thread). Tighten to 32 ft-lb.



TR144



TR189

6. Install the starter drive countershaft and countershaft gears.

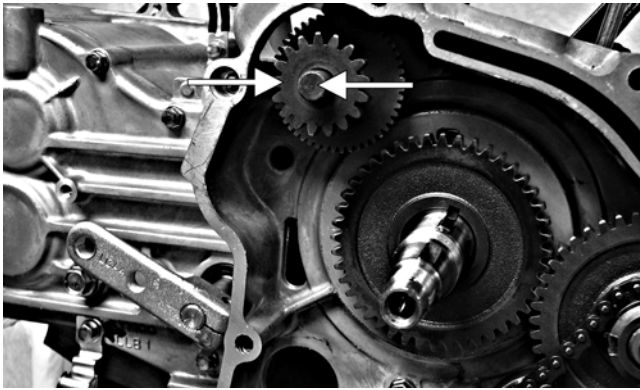

TR190A

7. Install the inner starter one-way drive washer with the word INSIDE directed toward the crankshaft drive gear; then install a key and the starter one-way drive assembly.



TR144



TR096

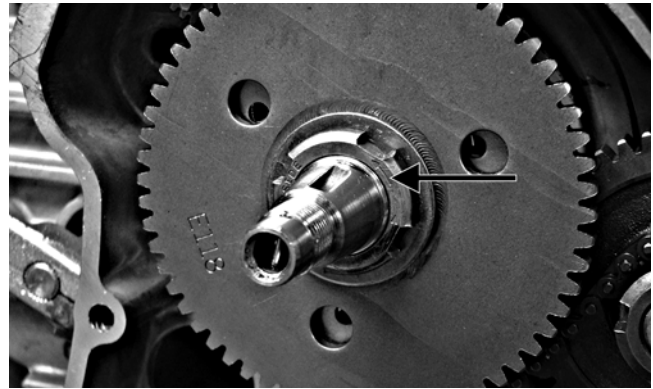

TR191A

9. Install the oil pump baffle and secure with two cap screws. Tighten to 7 ft-lb.



TR190B

8. Install the outer starter one-way drive washer with the word INSIDE directed toward the starter one-way drive assembly; then coat the crankshaft threads with red Loctite #271 and secure with the nut (left-hand thread). Tighten to 68 ft-lb.



TR193

10. Install the starter motor (if removed) and tighten the mounting screws to 7 ft-lb.
11. Install a key in the crankshaft; then install the rotor/flywheel and flat washer and secure with the rotor/flywheel nut. Tighten to 40 ft-lb.



TR192

12. Place the two alignment pins and a new gasket onto the crankcase; then install the magneto cover assembly and secure with the cap screws. Tighten in a crisscross pattern to 7 ft-lb.

■NOTE: Account for the position of the short cap screw.

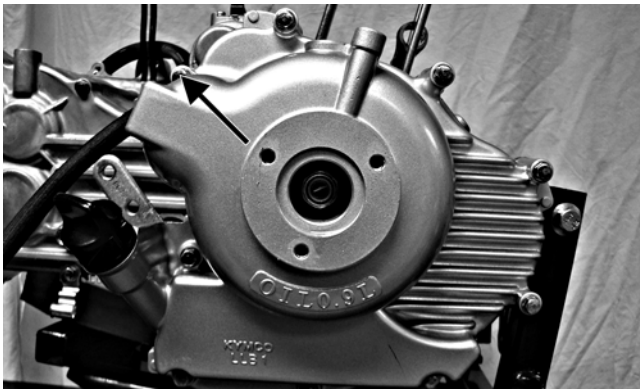

TR196A

13. Place the oil through into the end of the crankshaft; then install the magneto cover and secure with three cap screws. Tighten to 7 ft-lb.



TR047



TR197

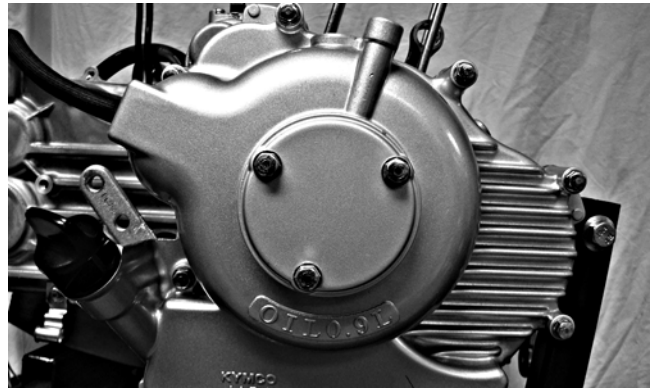

TR198

■NOTE: The cover can only be installed one way as the holes are drilled off-set.

---

## Disassembling Crankcase Half

---

- A. Crankshaft
- B. Crankshaft Balancer Shaft
- C. Timing Chain
- D. Secondary Transmission

■NOTE: Prior to disassembling the crankcase, the left-side, right-side, and top-side components must be removed.

1. Make match marks on the shift lever and shaft; then remove the cap screw and remove the shift arm.

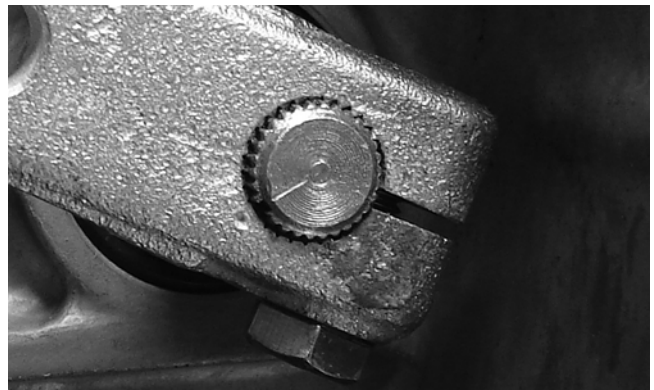

TR107

- Remove the starter motor. Account for two cap screws and one O-ring.
- Remove nine right-side cap screws and one left-side cap screw securing the crankcase halves together; then using a plastic mallet, tap the right-side case from the left-side case leaving all components in the left-side case. Account for two alignment pins and a gasket.

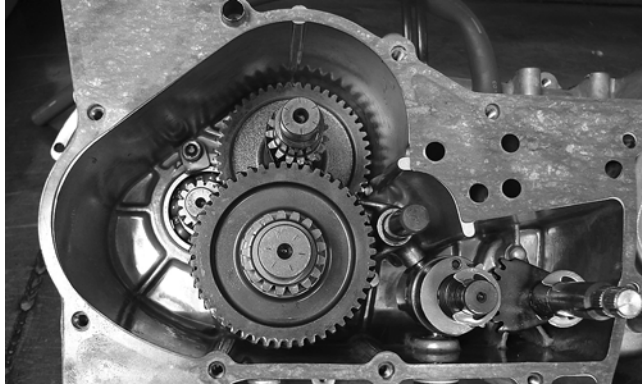

TR115

- Remove the balancer shaft; then remove the crankshaft assembly and camshaft drive chain.



TR112

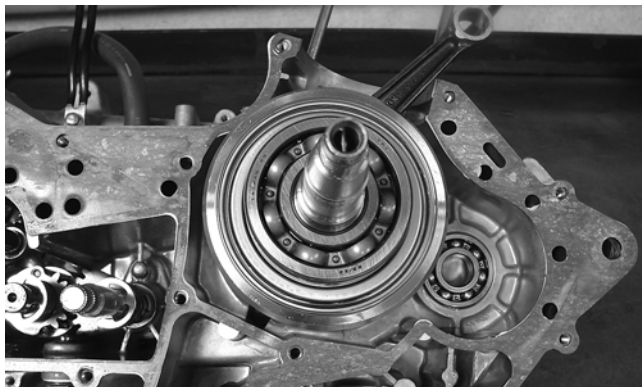

TR113

- Remove the shift detent bolt, spring, and detent ball.

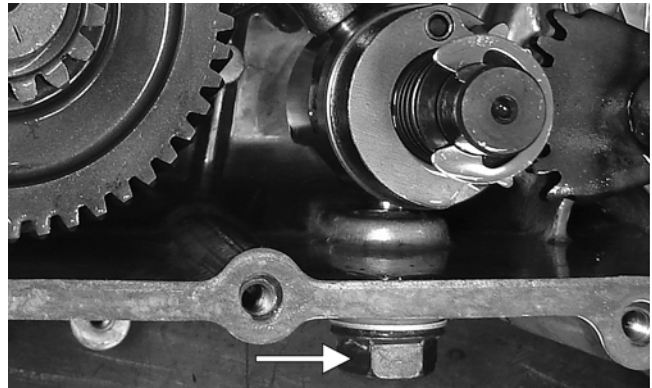

TR116A

■NOTE: For steps 6-9, use photo TR115A.

- Remove the shift shaft (A); then remove the shift fork shaft (B) and holding the shift fork away from the shift cam (C), remove the shift cam.

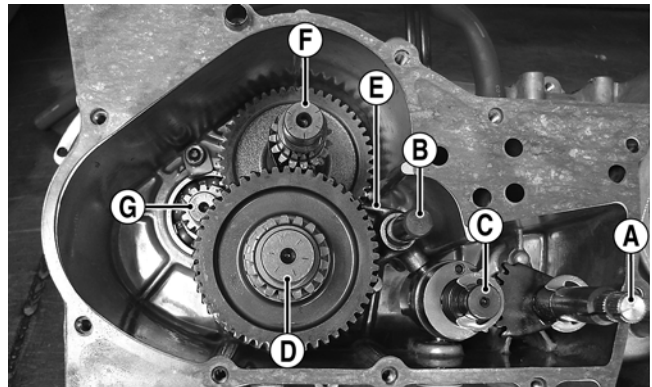

TR115A

- Remove the main shaft assembly (D) along with the shift fork (E). Account for a spacer and washer.
- Remove the countershaft (F).
- Remove two cap screws securing the bearing retainers to the crankcase; then using a press or plastic mallet, remove the driveshaft assembly (G) from the crankcase.

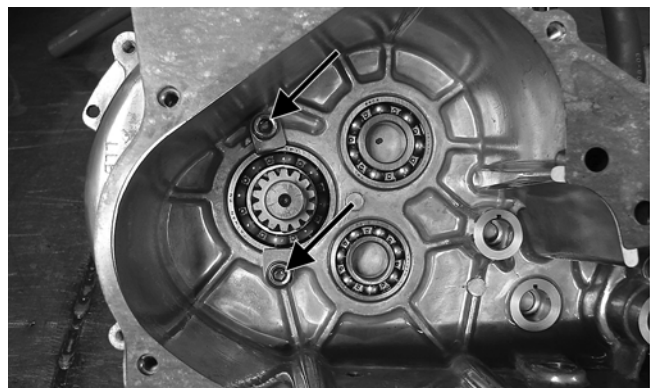

TR120A

- Using the appropriate bearing puller or driver, remove the required bearings from the crankcase halves.

3

## Servicing Center Crankcase Components

To disassemble the main shaft, use the following procedure.

1. Remove the spacer (A), washer (B), forward gear (C), and forward gear bushing (D).

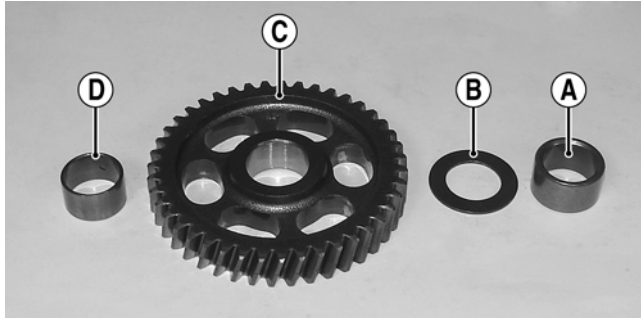

TR130A

2. Remove the forward/reverse shift dog (E); then remove the snap ring (F).

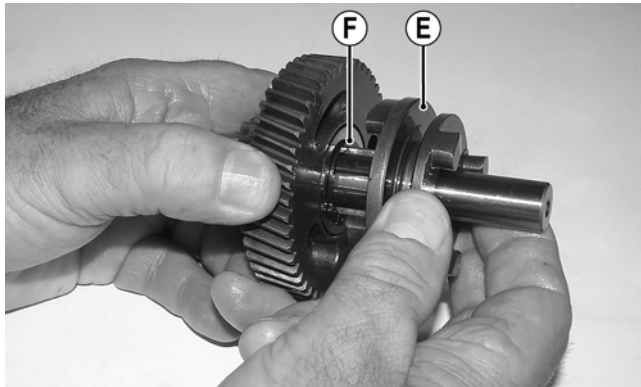

TR133A

3. Remove the splined washer (G); then remove the reverse gear (I), reverse gear bearing (H), and thrust washer (J). The main shaft is now disassembled for inspection of components.

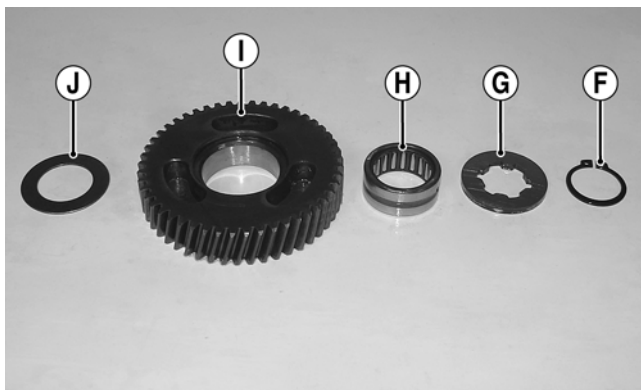

TR131A

### INSPECTING

1. Inspect all gear teeth and shift dog lugs for excessive wear or chipping.

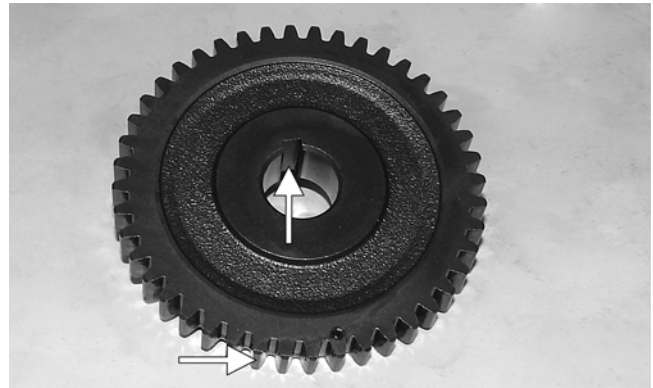

TR145A

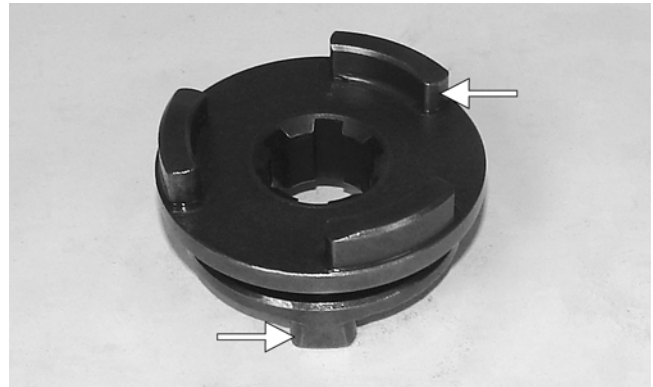

TR142A

2. Inspect the transmission shafts, bushings, and bearings for excessive wear or discoloration.

3. Check splines for excessive wear or twisting.

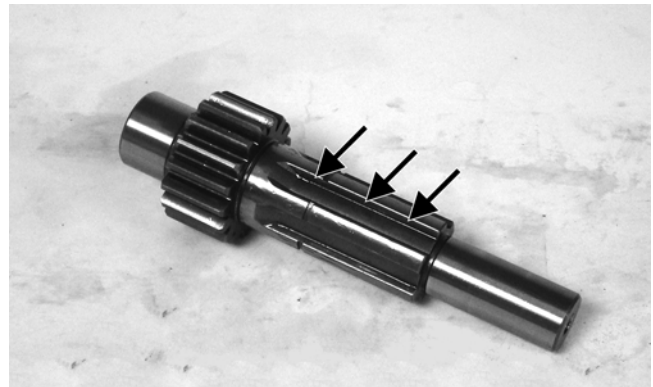

TR162A

4. Check shift fork for excessive wear or discoloration.

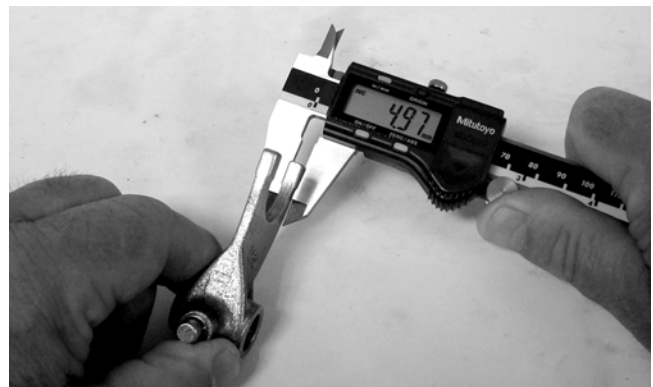

TR153



5. Check shift fork shaft for distortion. Maximum distortion (runout) must not exceed specifications.

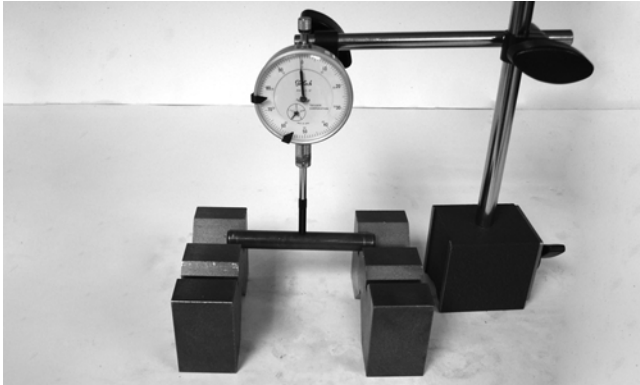

TR155

6. Inspect crankshaft bearings for smoothness of turning and any signs of discoloration.



TR160

7. Using V-blocks and a dial gauge, check crankshaft runout. Maximum runout must not exceed specifications.

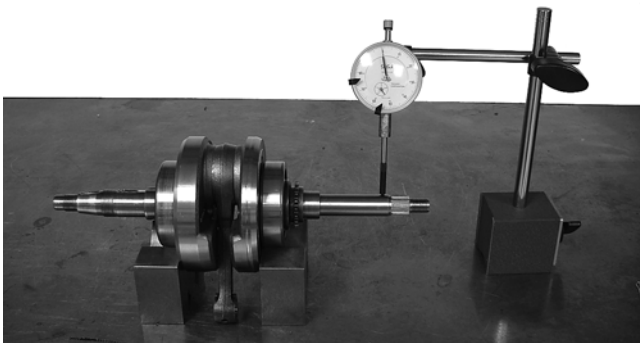

TR121

8. Check connecting rod small-end deflection. Maximum deflection must not exceed specifications.

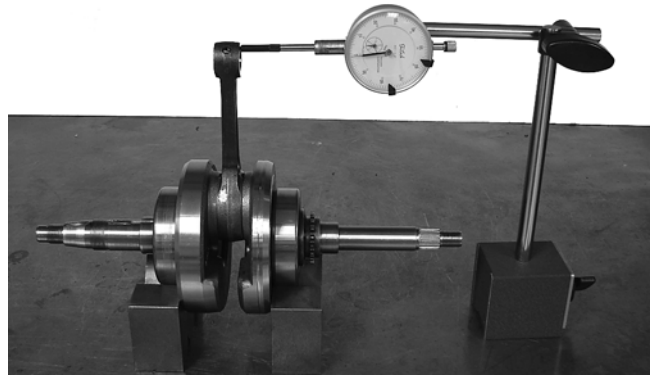

TR122

9. Measure the connecting rod to crankshaft clearance using a thickness gauge. The measurement must not exceed specifications.



TR124

10. Using a snap gauge and micrometer, measure the connecting rod small-end inside diameter. The measurement must not exceed specifications.

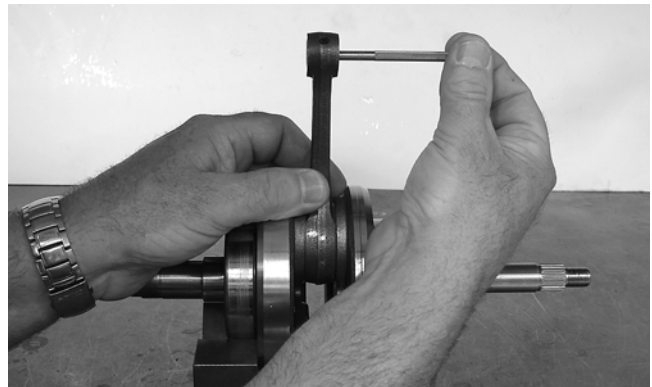

TR128



TR129

3

11. Using an appropriate micrometer or caliper, measure the crankshaft web-to-web width. If the measurement exceeds specifications, the crankshaft must be repaired or replaced.



TR140

12. Check all case bearings for smoothness of rotation, tightness in case, and discoloration. If bearings are loose in the case or discolored, the crankcase assembly must be replaced.

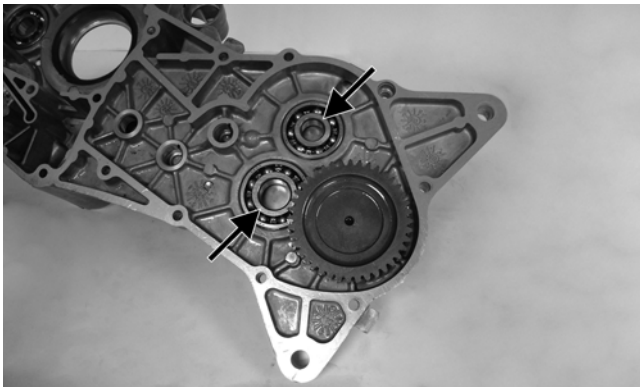

TR159A

13. Inspect the shift cam for excessive wear or broken springs.

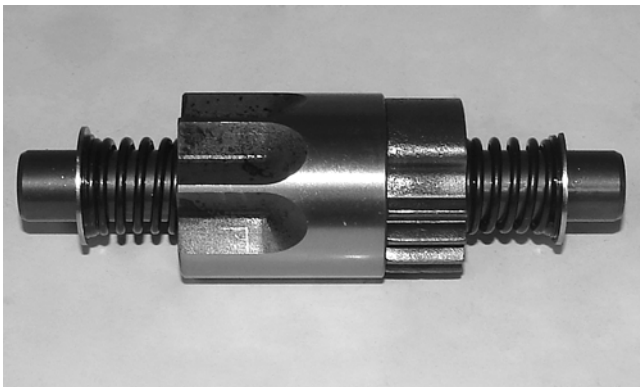

TR139

1. Coat the lips of the seal and bearings with gear oil; then using a press or suitable driver, install the driveshaft and bearing into the left-side crankcase half.

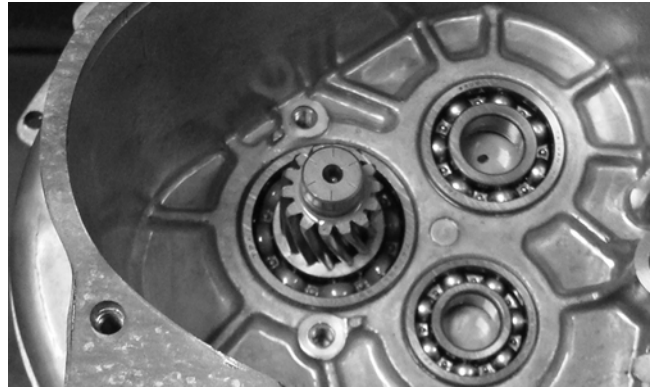

TR165

2. Coat the bearing retainer cap screw threads with blue Loctite #242 and secure the bearing retainers. Tighten securely.

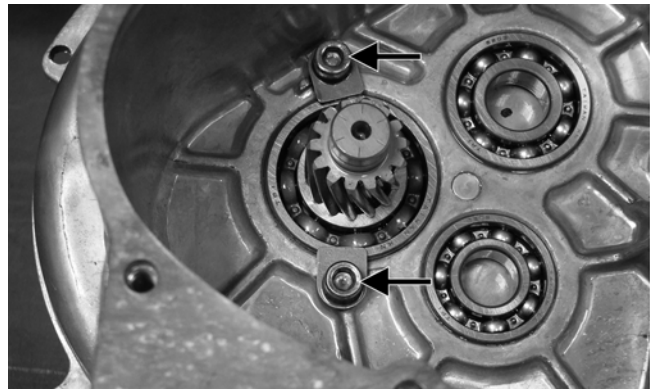

TR164A

### CAUTION

Make sure the bearing retainers are properly seated against the retainer stops or damage to the transmission will occur.



TR163A

3. Install the countershaft; then install the assembled main shaft into the case making sure the bushing and washer are in place on the main shaft.

## Assembling Crankcase Half

■NOTE: Coat all bearings, shafts, gears, and seals with gear lubricant when installing.

[www.mymowerparts.com](http://www.mymowerparts.com)

Back

Back to TOC

Back to Section TOC

Next

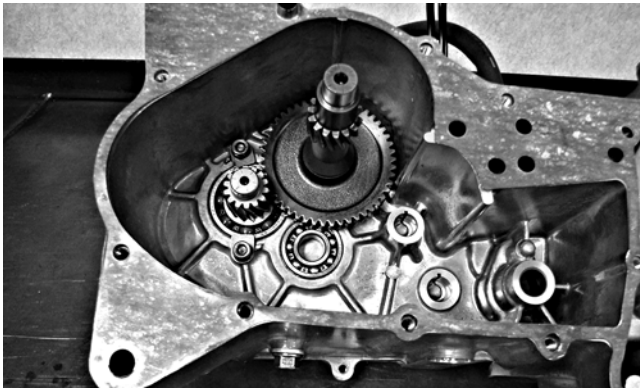

TR175

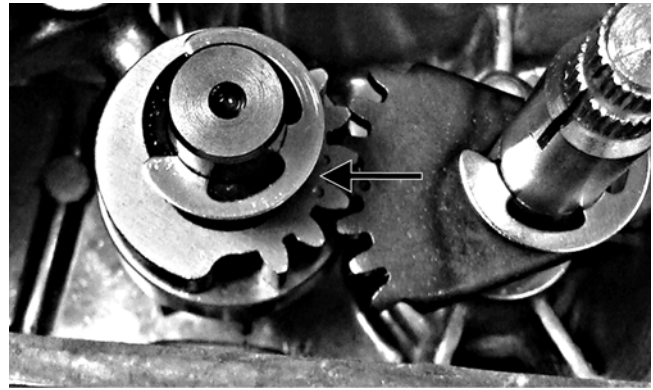

TR179A



TR176

4. Install the shift fork; then install the shift cam and shift fork shaft.

6. Install the timing chain into the case; then apply grease to the lips of the crankshaft seal and install the crankshaft.



TR180

■NOTE: To simplify holding the timing chain in position on the lower end, pack a small amount of all-purpose grease into the case and “stick” the chain in place.

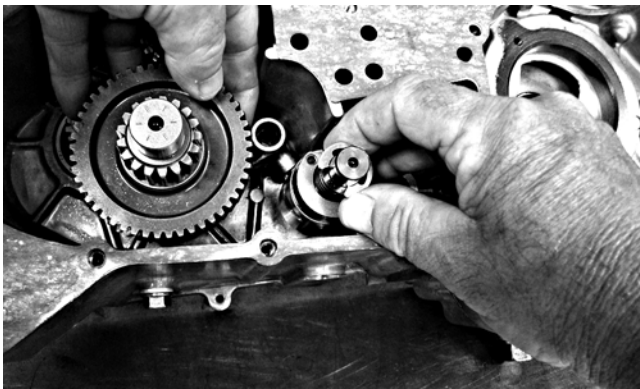

TR177

7. Install the balancer shaft; then install the right-side crankcase half with a new gasket.



TR178

5. Install the shift shaft making sure the timing marks are matched.

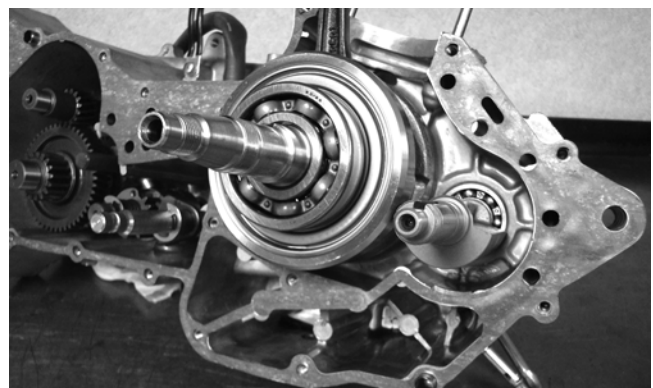

TR181

8. Lightly tap the case halves together until fully seated; then secure with nine right-side cap screws and one left-side cap screw.

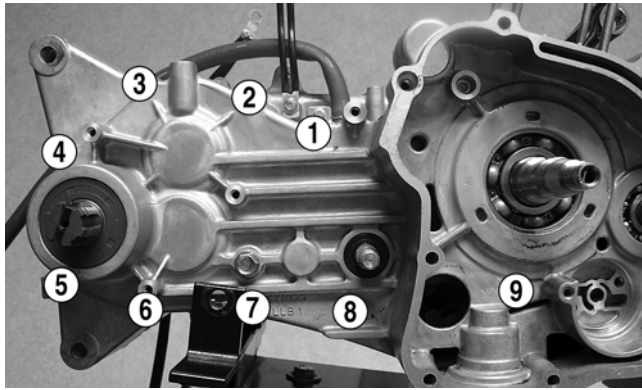

TR108A

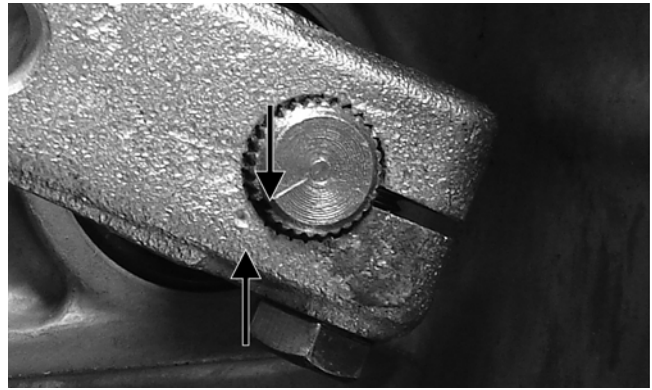

TR107A

## Installing Engine/Transmission

1. From the left side of the frame, install the engine/transmission assembly.
2. Install the left front engine mounting bracket onto the frame and tighten the cap screws to 29 ft-lb; then install the three through bolts and nuts and tighten to 29 ft-lb.
3. Install the drive sprocket, retainer, and retainer cap screws. Tighten to 40 ft-lb. Install the drive sprocket guard.



TR110A

### CAUTION

**Do not draw the case halves together with the crankcase cap screws. Damage to the case may occur.**

9. Tighten the cap screws (from step 8) in a criss-cross pattern to 7 ft-lb.
10. Install the shift detent ball, spring, and shift detent bolt. Tighten to 35 ft-lb.

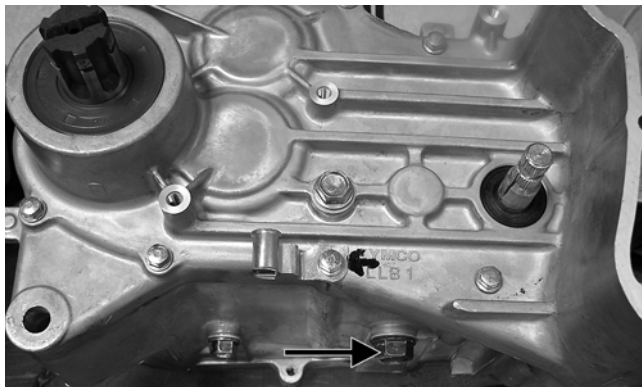

TR109A

11. Install the shift lever aligning the match marks; then install the cap screw and tighten securely.

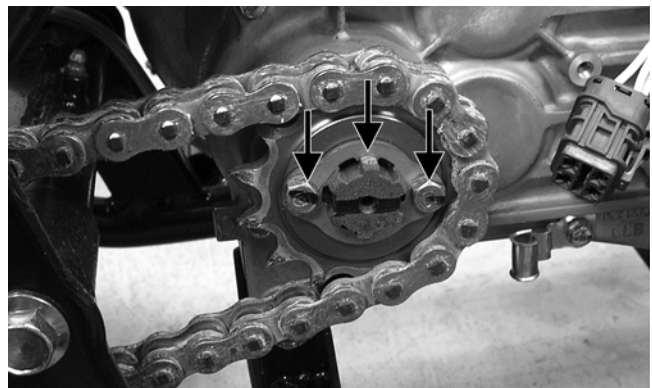

TR075A

■ **NOTE:** If the drive chain was loosened to remove the sprocket, adjust drive chain (see Section 2).

4. Using a new grafoil gasket, install the exhaust pipe/muffler assembly and loosely secure with the mounting cap screws.

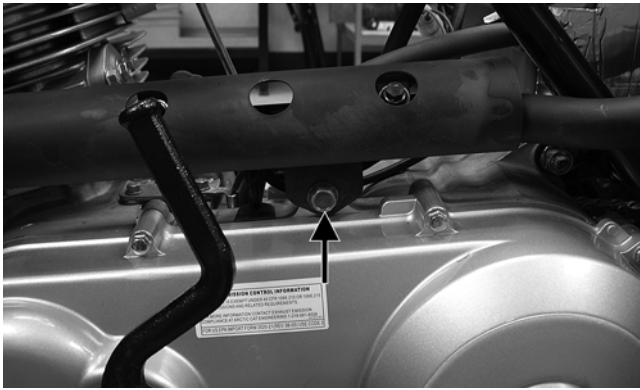

TR062A

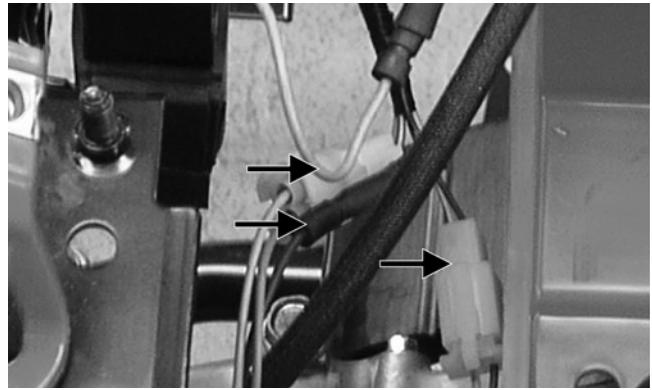

TR070A

7. Install the CVT cooling ducts making sure to align the notches in the boots with the location lugs. Tighten the clamps securely.

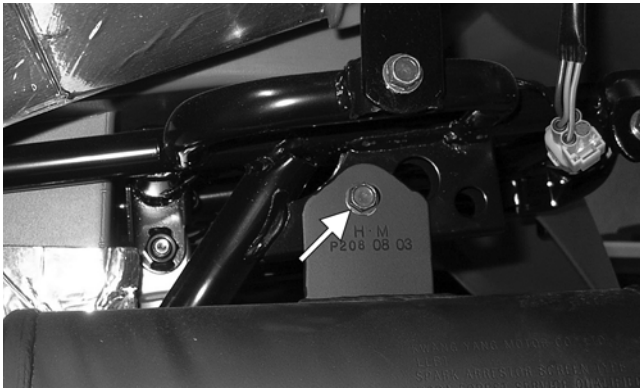

TR073A

5. Place the two sealing wedges (A) into the cylinder head and secure with the exhaust flange (B). Secure with the two nuts and tighten to 25 ft-lb.

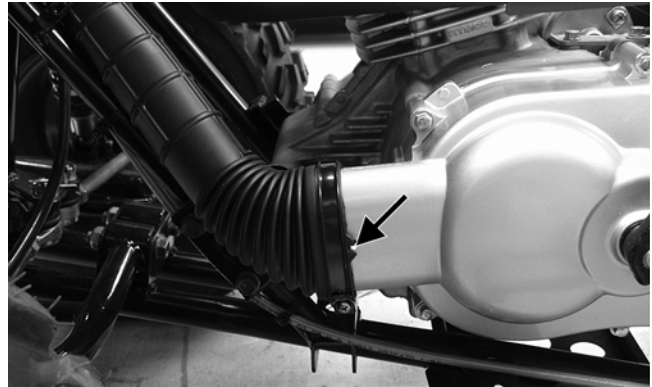

TR063A

3

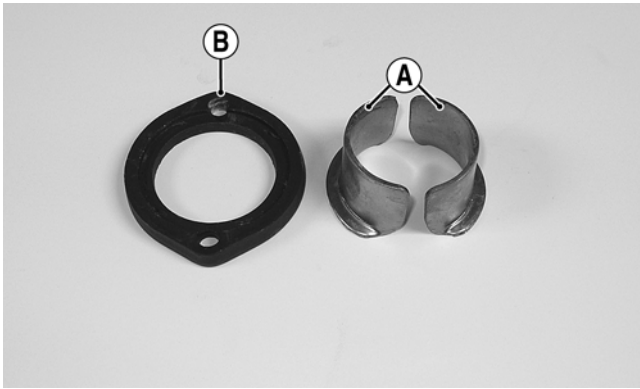

TR041A

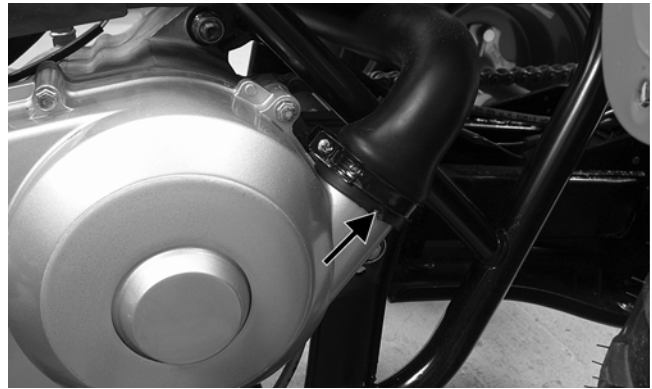

TR061A

8. Connect the AC generator plug; then install a cable tie at marked location.

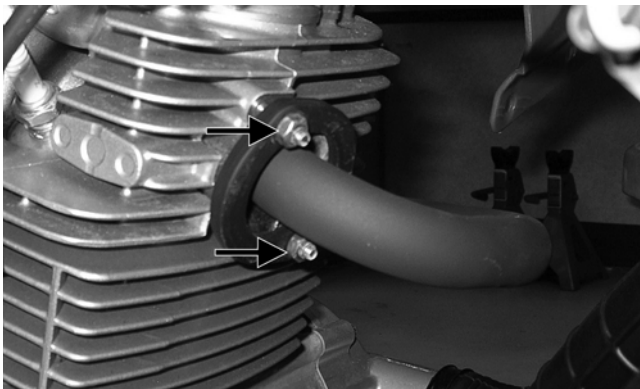

TR067A

6. Connect the gear shift position switch, trigger coil, and signal coil connectors.

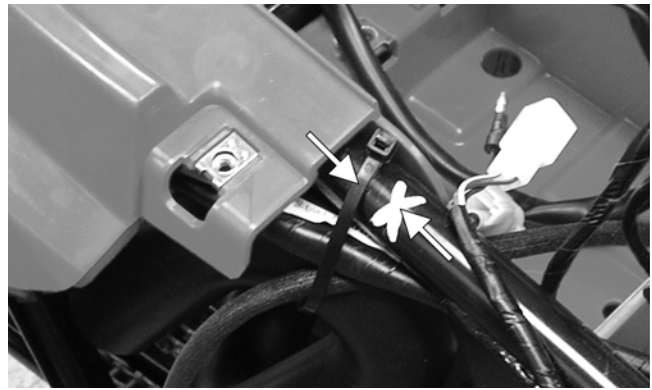

TR072A

9. From the right-side, connect the shift rod to the lower shift arm, then connect the starter lead and install the spark plug cap.



TR059A

10. Install the carburetor assembly and secure the intake pipe to the cylinder with two nuts. Tighten securely.

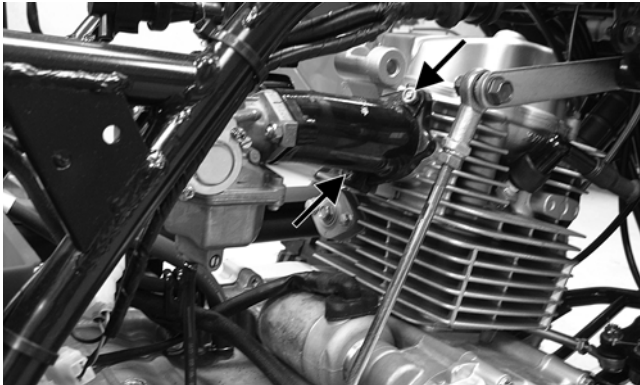

TR058A

11. Install the air filter assembly; then connect the crankcase breather hose to the crankcase ventilator valve.



TR049

12. Install the gas tank (see Section 4); then install the left-side and right-side footwells and side covers.
13. Connect the battery and install the seat.
14. Pour in the proper quantities of engine/transmission oil; then start the engine and warm up to operating temperature.
15. Check for leaks; then shut off engine and check levels (see Section 2).

## Troubleshooting

<b>Problem: Engine will not start or is hard to start (Compression too low)</b>	
<b>Condition</b>	<b>Remedy</b>
<ol style="list-style-type: none"> <li>1. <b>Valve clearance</b> out of adjustment</li> <li>2. <b>Valve guides</b> worn - seated poorly</li> <li>3. <b>Valves</b> mistimed</li> <li>4. <b>Piston rings</b> worn excessively</li> <li>5. <b>Cylinder bore</b> worn</li> <li>6. <b>Spark plug</b> seating poorly</li> <li>7. <b>Starter motor</b> cranks too slowly - does not turn</li> </ol>	<ol style="list-style-type: none"> <li>1. Adjust clearance</li> <li>2. Repair - replace guides</li> <li>3. Adjust valve timing</li> <li>4. Replace rings</li> <li>5. Replace cylinder</li> <li>6. Tighten plug</li> <li>7. See Section 5</li> </ol>
<b>Problem: Engine will not start or is hard to start (No spark)</b>	
<b>Condition</b>	<b>Remedy</b>
<ol style="list-style-type: none"> <li>1. <b>Spark plug</b> fouled</li> <li>2. <b>Spark plug</b> wet</li> <li>3. <b>Magneto</b> defective</li> <li>4. <b>CDI unit</b> defective</li> <li>5. <b>Ignition coil</b> defective</li> <li>6. <b>High-tension lead</b> open - shorted</li> </ol>	<ol style="list-style-type: none"> <li>1. Clean - replace plug</li> <li>2. Clean - dry plug</li> <li>3. Replace magneto</li> <li>4. Replace CDI unit</li> <li>5. Replace ignition coil</li> <li>6. Replace high tension lead</li> </ol>
<b>Problem: Engine will not start or is hard to start (No fuel reaching the carburetor)</b>	
<b>Condition</b>	<b>Remedy</b>
<ol style="list-style-type: none"> <li>1. <b>Gas tank vent hose</b> obstructed</li> <li>2. <b>Carburetor inlet needle</b> defective</li> <li>3. <b>Fuel hose</b> obstructed</li> <li>4. <b>Fuel screens</b> obstructed</li> </ol>	<ol style="list-style-type: none"> <li>1. Clean vent hose</li> <li>2. Replace needle</li> <li>3. Clean - replace hose</li> <li>4. Clean - replace inlet screen - valve screen</li> </ol>
<b>Problem: Engine stalls easily</b>	
<b>Condition</b>	<b>Remedy</b>
<ol style="list-style-type: none"> <li>1. <b>Spark plug</b> fouled</li> <li>2. <b>Magneto</b> defective</li> <li>3. <b>CDI unit</b> defective</li> <li>4. <b>Carburetor jets</b> obstructed</li> <li>5. <b>Valve clearance</b> out of adjustment</li> </ol>	<ol style="list-style-type: none"> <li>1. Clean plug</li> <li>2. Replace magneto</li> <li>3. Replace CDI unit</li> <li>4. Clean jets</li> <li>5. Adjust clearance</li> </ol>
<b>Problem: Engine noisy (Excessive valve chatter)</b>	
<b>Condition</b>	<b>Remedy</b>
<ol style="list-style-type: none"> <li>1. <b>Valve clearance</b> too large</li> <li>2. <b>Valve spring(s)</b> weak - broken</li> <li>3. <b>Rocker arm</b> - rocker arm shaft worn</li> <li>4. <b>Camshaft</b> worn</li> </ol>	<ol style="list-style-type: none"> <li>1. Adjust clearance</li> <li>2. Replace spring(s)</li> <li>3. Replace arm - shaft</li> <li>4. Replace camshaft</li> </ol>
<b>Problem: Engine noisy (Noise seems to come from piston)</b>	
<b>Condition</b>	<b>Remedy</b>
<ol style="list-style-type: none"> <li>1. <b>Piston - cylinder</b> worn</li> <li>2. <b>Combustion chamber carbon</b> buildup</li> <li>3. <b>Piston pin - piston pin bore</b> worn</li> <li>4. <b>Piston rings - ring groove(s)</b> worn</li> </ol>	<ol style="list-style-type: none"> <li>1. Replace - service piston - cylinder</li> <li>2. Clean chamber</li> <li>3. Replace - service pin - bore</li> <li>4. Replace rings - piston</li> </ol>
<b>Problem: Engine noisy (Noise seems to come from timing chain)</b>	
<b>Condition</b>	<b>Remedy</b>
<ol style="list-style-type: none"> <li>1. <b>Chain</b> stretched</li> <li>2. <b>Sprockets</b> worn</li> <li>3. <b>Tension adjuster</b> malfunctioning</li> </ol>	<ol style="list-style-type: none"> <li>1. Replace chain</li> <li>2. Replace sprockets</li> <li>3. Repair - replace adjuster</li> </ol>

<b>Problem: Engine noisy (Noise seems to come from crankshaft)</b>	
<b>Condition</b>	<b>Remedy</b>
<ol style="list-style-type: none"> <li>1. <b>Bearing</b> worn - burned</li> <li>2. <b>Lower rod-end bearing</b> worn - burned</li> <li>3. <b>Connecting rod side clearance</b> too large</li> </ol>	<ol style="list-style-type: none"> <li>1. Replace bearing</li> <li>2. Replace bearing</li> <li>3. Replace thrust washer(s)</li> </ol>
<b>Problem: Engine noisy (Noise seems to come from transmission)</b>	
<b>Condition</b>	<b>Remedy</b>
<ol style="list-style-type: none"> <li>1. <b>Gears</b> worn - rubbing</li> <li>2. <b>Splines</b> worn</li> <li>3. <b>Primary gears</b> worn - rubbing</li> <li>4. <b>Bearings</b> worn</li> <li>5. <b>Bushing</b> worn</li> </ol>	<ol style="list-style-type: none"> <li>1. Replace gears</li> <li>2. Replace shaft(s)</li> <li>3. Replace gears</li> <li>4. Replace bearings</li> <li>5. Replace bushing</li> </ol>
<b>Problem: Engine noisy (Noise seems to come from secondary-transmission/right-side cover)</b>	
<b>Condition</b>	<b>Remedy</b>
<ol style="list-style-type: none"> <li>1. <b>Gears - shaft(s)</b> worn</li> <li>2. <b>Bearing(s)/bushing(s)</b> damaged</li> </ol>	<ol style="list-style-type: none"> <li>1. Replace gears - shafts</li> <li>2. Replace bearing(s)/bushing(s)</li> </ol>
<b>Problem: Engine noisy (Noise seems to come from secondary bevel gear and final driven shaft)</b>	
<b>Condition</b>	<b>Remedy</b>
<ol style="list-style-type: none"> <li>1. <b>Drive - driven bevel gears</b> damaged - worn</li> <li>2. <b>Backlash</b> excessive</li> <li>3. <b>Tooth contact</b> improper</li> <li>4. <b>Bearing</b> damaged</li> <li>5. <b>Gears</b> worn - rubbing</li> <li>6. <b>Splines</b> worn</li> <li>7. <b>Final driven shaft thrust clearance</b> too large</li> </ol>	<ol style="list-style-type: none"> <li>1. Replace gears</li> <li>2. Adjust backlash</li> <li>3. Adjust contact</li> <li>4. Replace bearing</li> <li>5. Replace gears</li> <li>6. Replace shaft(s)</li> <li>7. Replace thrust washer(s)</li> </ol>
<b>Problem: Centrifugal clutch slipping</b>	
<b>Condition</b>	<b>Remedy</b>
<ol style="list-style-type: none"> <li>1. <b>Clutch shoes</b> worn</li> <li>2. <b>Clutch housing</b> excessively worn</li> <li>3. <b>Drive belt</b> slipping - worn</li> </ol>	<ol style="list-style-type: none"> <li>1. Replace shoes</li> <li>2. Replace clutch housing</li> <li>3. Replace drive belt</li> </ol>
<b>Problem: Secondary-transmission will not shift or shift back</b>	
<b>Condition</b>	<b>Remedy</b>
<ol style="list-style-type: none"> <li>1. <b>Sliding dog</b> broken - worn</li> <li>2. <b>Gearshift fork</b> broken - worn</li> <li>3. <b>Shift lever</b> out of adjustment</li> <li>4. <b>Gearshift cam</b> worn</li> <li>5. <b>Cam stopper spring</b> weak</li> <li>6. <b>Gearshift fork shaft</b> worn</li> <li>7. <b>Engine idle</b> too high</li> <li>8. <b>Shift linkage</b> out of adjustment</li> </ol>	<ol style="list-style-type: none"> <li>1. Replace dog</li> <li>2. Replace fork</li> <li>3. Adjust lever</li> <li>4. Replace cam</li> <li>5. Replace spring</li> <li>6. Replace shaft</li> <li>7. Adjust engine idle</li> <li>8. Adjust shift linkage</li> </ol>
<b>Problem: Engine idles poorly</b>	
<b>Condition</b>	<b>Remedy</b>
<ol style="list-style-type: none"> <li>1. <b>Valve clearance</b> out of adjustment</li> <li>2. <b>Valve seating</b> poor</li> <li>3. <b>Valve guides</b> defective</li> <li>4. <b>Rocker arms - arm shaft</b> worn</li> <li>5. <b>Magneto</b> defective</li> <li>6. <b>CDI unit</b> defective</li> <li>7. <b>Spark plug</b> fouled - gap too wide</li> <li>8. <b>Ignition coil</b> defective</li> <li>9. <b>Float</b> out of adjustment</li> <li>10. <b>Jets</b> obstructed</li> <li>11. <b>Pilot screw</b> setting improper</li> </ol>	<ol style="list-style-type: none"> <li>1. Adjust clearance</li> <li>2. Replace - service seats - valves</li> <li>3. Replace guides</li> <li>4. Replace arms - shafts</li> <li>5. Replace magneto</li> <li>6. Replace CDI unit</li> <li>7. Adjust gap - replace plug</li> <li>8. Replace ignition coil</li> <li>9. Adjust float height</li> <li>10. Clean jets</li> <li>11. Adjust pilot screw</li> </ol>



<b>Problem: Engine runs poorly at high speed</b>	
<b>Condition</b>	<b>Remedy</b>
<ol style="list-style-type: none"> <li>1. <b>High RPM "cut out"</b> against RPM limiter</li> <li>2. <b>Valve springs</b> weak</li> <li>3. <b>Valve timing</b> out of adjustment</li> <li>4. <b>Cams - rocker arms</b> worn</li> <li>5. <b>Spark plug gap</b> too narrow</li> <li>6. <b>Ignition coil</b> defective</li> <li>7. <b>Float level</b> too low</li> <li>8. <b>Air cleaner element</b> obstructed</li> <li>9. <b>Fuel hose</b> obstructed</li> </ol>	<ol style="list-style-type: none"> <li>1. Shift into higher gear - decrease speed</li> <li>2. Replace springs</li> <li>3. Adjust timing</li> <li>4. Replace cams - arms</li> <li>5. Adjust gap</li> <li>6. Replace ignition oil</li> <li>7. Adjust float height</li> <li>8. Clean element</li> <li>9. Clean - prime hose</li> </ol>
<b>Problem: Exhaust smoke dirty or heavy</b>	
<b>Condition</b>	<b>Remedy</b>
<ol style="list-style-type: none"> <li>1. <b>Oil (in the engine)</b> overfilled - contaminated</li> <li>2. <b>Piston rings - cylinder</b> worn</li> <li>3. <b>Valve guides</b> worn</li> <li>4. <b>Cylinder wall</b> scored - scuffed</li> <li>5. <b>Valve stems</b> worn</li> <li>6. <b>Stem seals</b> defective</li> <li>7. <b>Air cleaner element</b> obstructed</li> <li>8. <b>Float level</b> too high</li> </ol>	<ol style="list-style-type: none"> <li>1. Drain excess oil - replace oil</li> <li>2. Replace - service rings - cylinder</li> <li>3. Replace guides</li> <li>4. Replace - service cylinder</li> <li>5. Replace valves</li> <li>6. Replace seals</li> <li>7. Clean element</li> <li>8. Adjust float level</li> </ol>
<b>Problem: Engine lacks power</b>	
<b>Condition</b>	<b>Remedy</b>
<ol style="list-style-type: none"> <li>1. <b>Valve clearance</b> incorrect</li> <li>2. <b>Valve springs</b> weak</li> <li>3. <b>Valve timing</b> out of adjustment</li> <li>4. <b>Piston ring(s) - cylinder</b> worn</li> <li>5. <b>Valve seating</b> poor</li> <li>6. <b>Spark plug</b> fouled</li> <li>7. <b>Rocker arms - shafts</b> worn</li> <li>8. <b>Spark plug gap</b> incorrect</li> <li>9. <b>Carburetor jets</b> obstructed</li> <li>10. <b>Float level</b> out of adjustment</li> <li>11. <b>Air cleaner element</b> obstructed</li> <li>12. <b>Oil (in the engine)</b> overfilled - contaminated</li> <li>13. <b>Intake manifold</b> leaking air</li> <li>14. <b>Cam chain</b> worn</li> </ol>	<ol style="list-style-type: none"> <li>1. Adjust clearance</li> <li>2. Replace springs</li> <li>3. Adjust timing</li> <li>4. Replace - service rings - cylinder</li> <li>5. Repair seats</li> <li>6. Clean - replace plug</li> <li>7. Replace arms - shafts</li> <li>8. Adjust gap - replace plug</li> <li>9. Clean jets</li> <li>10. Adjust float height</li> <li>11. Clean element</li> <li>12. Drain excess oil - change oil</li> <li>13. Tighten - replace manifold</li> <li>14. Replace cam chain</li> </ol>
<b>Problem: Engine overheats</b>	
<b>Condition</b>	<b>Remedy</b>
<ol style="list-style-type: none"> <li>1. <b>Carbon deposit (piston crown)</b> excessive</li> <li>2. <b>Oil</b> low</li> <li>3. <b>Octane</b> low - gasoline poor</li> <li>4. <b>Oil pump</b> defective</li> <li>5. <b>Oil circuit</b> obstructed</li> <li>6. <b>Gasoline level (in float chamber)</b> too low</li> <li>7. <b>Intake manifold</b> leaking air</li> </ol>	<ol style="list-style-type: none"> <li>1. Clean piston</li> <li>2. Add oil</li> <li>3. Drain - replace gasoline</li> <li>4. Replace pump</li> <li>5. Clean circuit</li> <li>6. Adjust float height</li> <li>7. Tighten - replace manifold</li> </ol>

3



# SECTION 4 - FUEL/LUBRICATION/COOLING

---

---

## TABLE OF CONTENTS

---

Carburetor Specifications .....	4-2
Carburetor .....	4-2
Throttle Cable Free-Play .....	4-6
Engine RPM (Idle) .....	4-6
Gas Tank .....	4-6
Gas Tank Valve .....	4-7
Gas/Vent Hoses .....	4-8
Oil Flow Chart .....	4-8
Oil Pump .....	4-8
Troubleshooting .....	4-9

## Carburetor Specifications

Type	Keihin PTG 22
Main Jet	98
Slow Jet	35
Pilot Screw Setting (turns)	1 7/8
Needle Jet	3.6/2.5
Jet Needle	2MKNN
Idle RPM	1600-1800
Float Arm Height	14.8 mm
Throttle Cable Free-Play (at lever)	1-4 mm (1/16-3/16 in.)

## Carburetor

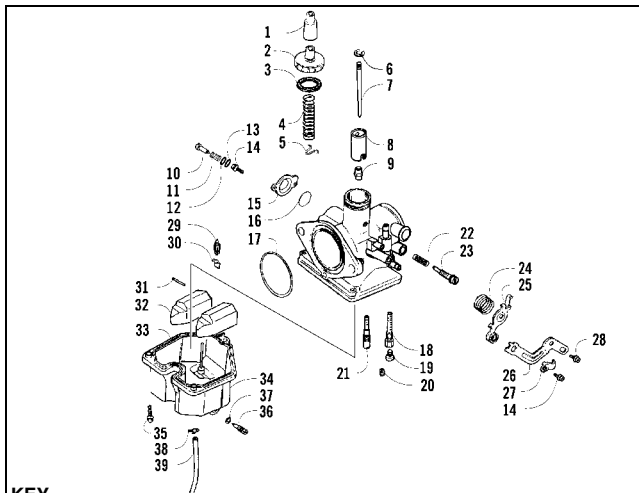

### KEY

1. Cap Seal	14. Machine Screw	27. Retaining Clamp
2. Cable Adjuster	15. Cover Plate	28. Machine Screw
3. Gasket	16. O-Ring	29. Float Valve
4. Spring	17. O-Ring	30. Float Valve Clip
5. Needle Clip	18. Needle Jet Holder	31. Float Arm Pin
6. E-Clip	19. Main Jet	32. Float
7. Jet Needle	20. Main Jet Holder	33. Float Chamber Gasket
8. Throttle Valve	21. Slow Jet	34. Float Chamber
9. Needle Jet	22. Spring	35. Machine Screw
10. Pilot Screw	23. Idle Adjust Screw	36. Drain Screw
11. Spring	24. Spring	37. O-Ring
12. Washer	25. Choke Lever	38. Hose Clamp
13. O-Ring	26. Choke Cable Bracket	39. Drain Tube

0743-813

### WARNING

Whenever any maintenance or inspection is performed on the fuel system during which there may be fuel leakage, there should be no welding, smoking, open flames, etc., in the area.

### REMOVING

1. Remove the seat; then remove the left-side heat shield and turn the gas tank shut-off valve to the

2. Remove the cap screws securing the air filter housing to the frame; then loosen the clamp securing air inlet boot to the carburetor and remove the air filter.



TR022B

3. Remove the choke assembly from the carburetor leaving the choke cable attached to the choke plunger.
4. Loosen the screw securing the choke cable to the carburetor; then disconnect the choke cable.
5. Remove the nuts securing the carburetor to the intake pipe; then remove the carburetor from the intake pipe.
6. Remove the gasoline hose from the carburetor.
7. Remove the throttle valve cap and throttle cable/throttle valve from the carburetor and remove the carburetor from the ATV. Secure the cable and throttle valve so the valve and needle will not be damaged.

### DISASSEMBLING

1. Remove the Phillips-head screws securing the float chamber; then remove the chamber. Account for the O-ring.

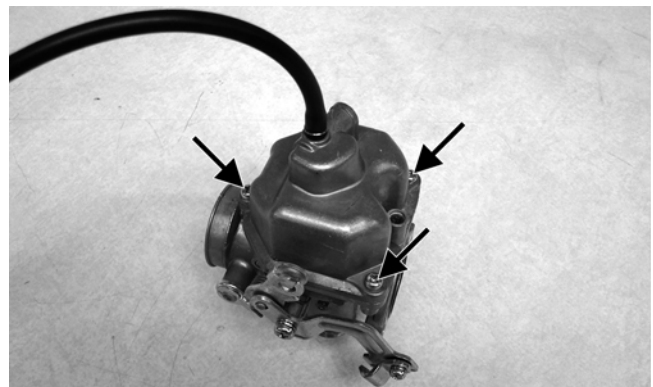

TR203A

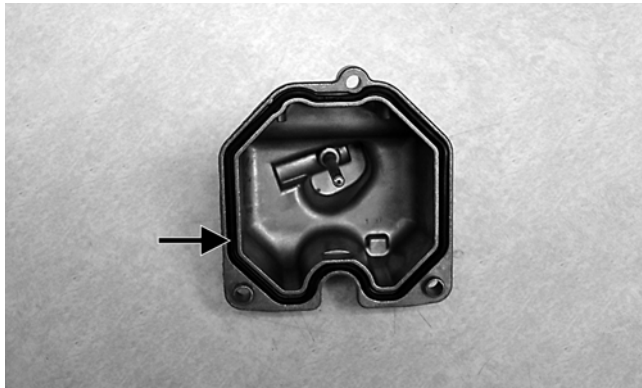

TR204A

2. Remove the float pin.

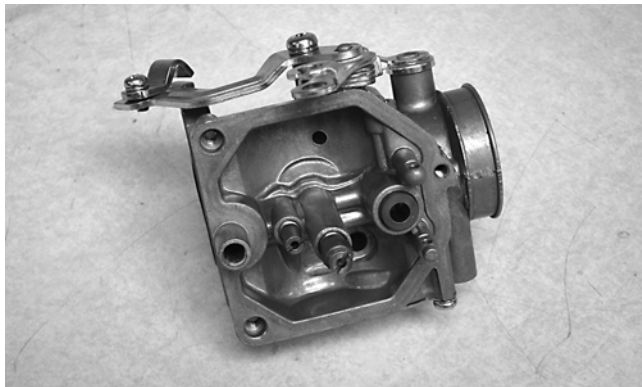

TR207

3. Lift the float assembly from the carburetor. Account for the float valve.

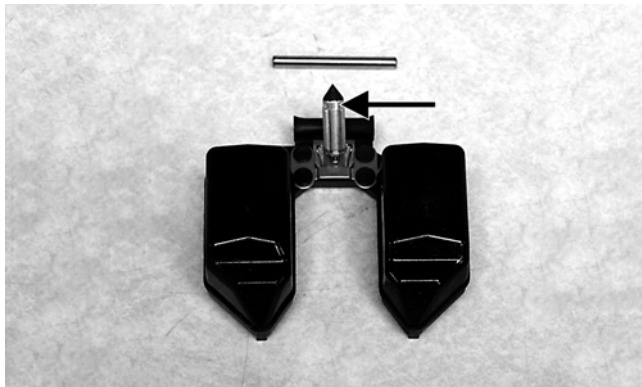

TR206A

■NOTE: Note the locations of the jets, pilot screw, and holder for disassembling procedures.

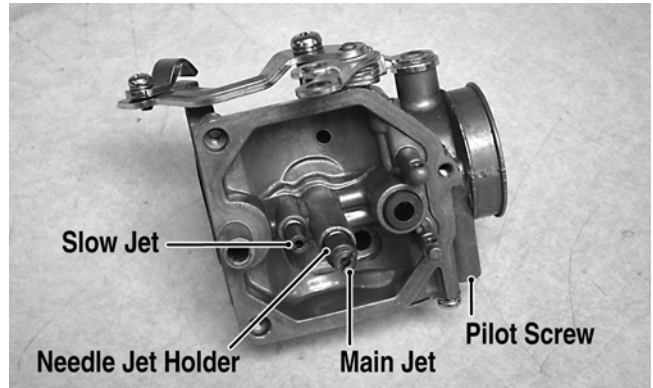

TR207A

4. Secure the needle jet holder with a wrench; then remove the main jet.

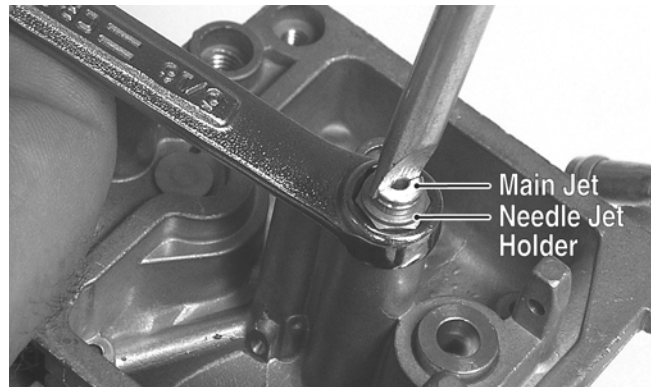

KC0030A

5. Remove the needle jet holder; then remove the slow jet.

6. Remove the pilot screw. Account for a spring, washer, and an O-ring.



TR211

4

### CLEANING AND INSPECTING

■NOTE: Whenever a part is worn excessively, cracked, or damaged in any way, replacement is necessary.

#### ⚠ WARNING

When drying components with compressed air, always wear safety glasses.

### CAUTION

**DO NOT** place any non-metallic components in parts-cleaning solvent because damage or deterioration will result.

1. Place all metallic components in a wire basket and submerge in carburetor cleaner.
2. Soak for 30 minutes; then rinse with clean, hot water.
3. Wash all non-metallic components with soap and water. Rinse thoroughly.
4. Dry all components with compressed air only making sure all holes, orifices, and channels are unobstructed.
5. Inspect the carburetor body for cracks, nicks, stripped threads, and any imperfections in the casting.
6. Inspect float for damage.
7. Inspect gasket and O-rings for distortion, tears, or noticeable damage.
8. Inspect tips of the jet needle, pilot screw, and the needle jet for wear, damage, or distortion.
9. Inspect the slow jet and main jet for obstructions or damage.

**NOTE:** If the slow jet is obstructed, the mixture will be extremely lean at idle and part-throttle operation.

10. Inspect the float valve for wear or damage.
11. Inspect the carburetor mounting flange for damage and tightness.

### ASSEMBLING

1. Install the pilot screw, spring, washer, and O-ring.

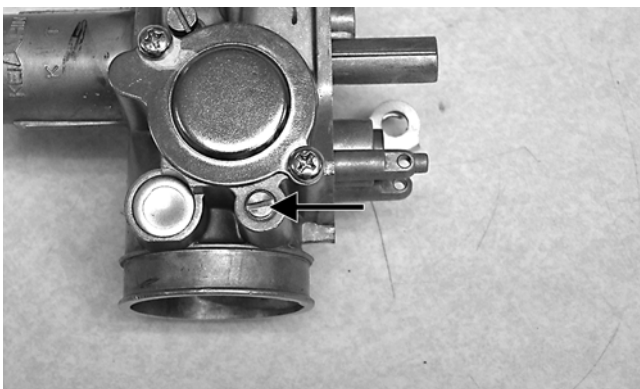

**NOTE:** Turn the pilot screw clockwise until it is lightly seated; then turn it counterclockwise the recommended number of turns as an initial setting.

**NOTE:** Note the locations of the jets and holder during assembling procedures.

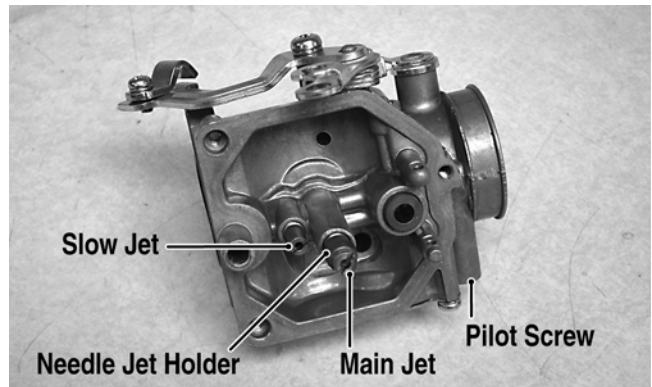

2. Install the slow jet. Tighten securely.
3. Install the main jet into the needle jet holder and tighten securely; then install the needle jet holder assembly into the carburetor and tighten securely.
4. Place the float assembly (with float valve) into position and secure to the carburetor with the float pin.

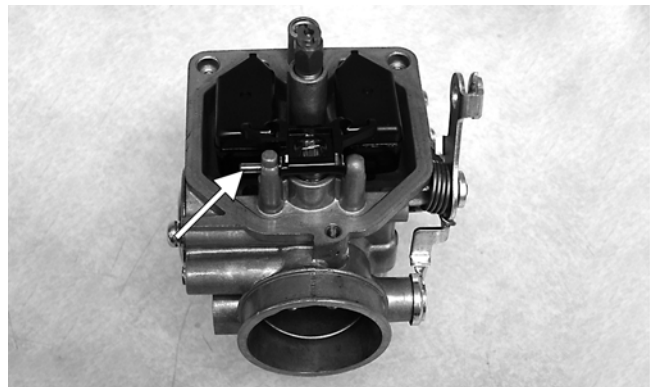

**NOTE:** Check float arm height by placing the carburetor on its side w/float contacting the needle; then measure with a caliper the height when the float arm is in contact with the needle valve. Float arm height should be 14.8 mm.

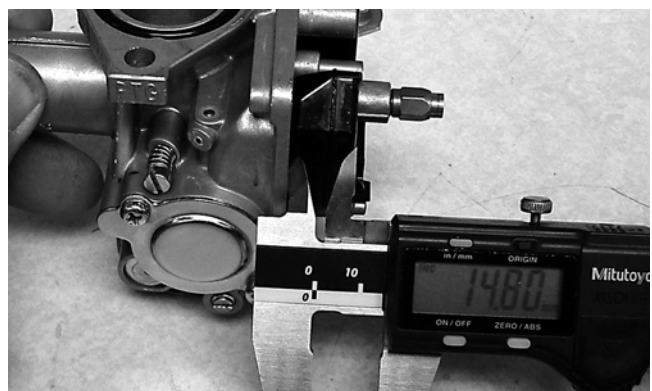

5. Place the float chamber into position making sure the O-ring is properly positioned; then secure with the Phillips-head screws.

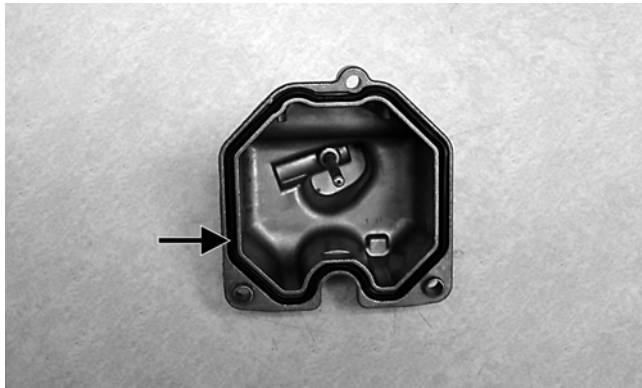

TR204A

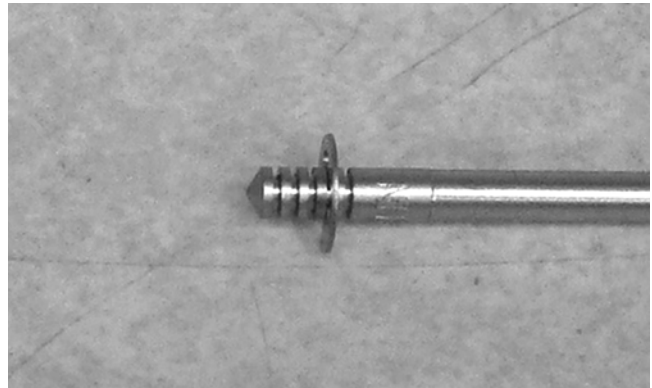

TR216

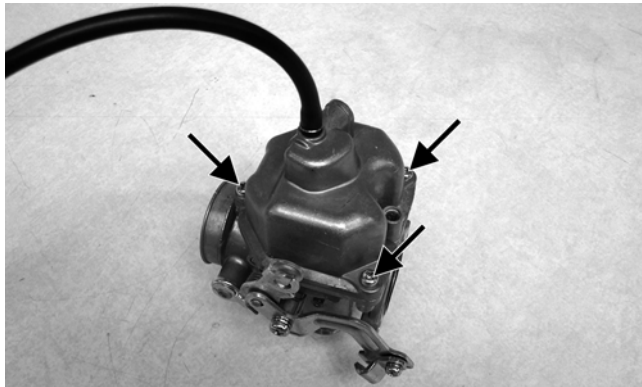

TR203A



TR214

4

## INSTALLING

1. If removed, connect the vent hose onto the carburetor.
2. If the throttle valve was removed, install the jet needle (C), needle holder (B), and spring (A) into the throttle valve (D) making sure the E-clip on the needle is in the fourth groove (counting from the top); then connect it to the throttle cable.

3. Slide the throttle valve into the carburetor making sure the alignment pin in the carburetor engages in the throttle valve groove; then secure the assembly into the carburetor with the cap and tighten securely.

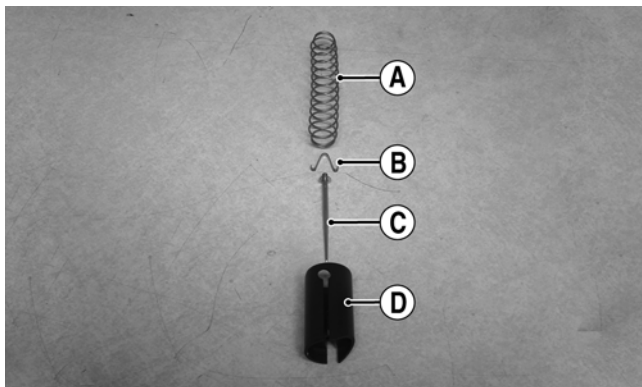

TR215A

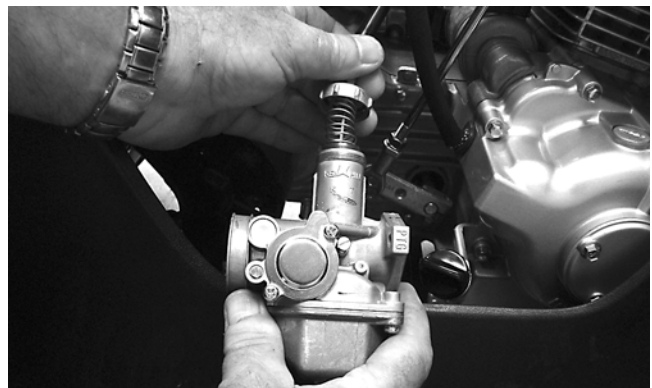

TR202

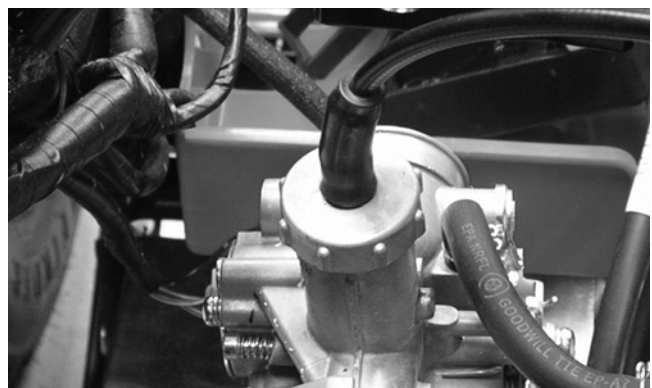

TR053

4. Connect the gasoline hose to the carburetor and secure with the clamp; then connect the choke cable and tighten the screw securely.
5. Making sure the O-ring is in position on the carburetor, position the carburetor onto the intake pipe and secure with two nuts. Tighten securely.
6. Install the air filter and secure the inlet boot to the carburetor with the clamp; then install two cap screws to secure the air filter housing to the frame and tighten securely.
7. Turn the gas tank shut-off valve to the ON position and check for leaks; then start the engine and adjust the idle as required (see Engine RPM (Idle) in this section).
8. Install the left-side heat shield and seat.

3. Tighten the jam nut against the throttle cable adjuster securely; then slide the rubber boot over the adjuster.

---

---

## Engine RPM (Idle)

---

To properly adjust the idle RPM, a tachometer is necessary. To adjust idle RPM, use the following procedure.

■ **NOTE:** The idle adjustment screw is located on the right side of the carburetor.



TR030

---

---

## Throttle Cable Free-Play

---

To adjust throttle cable free-play, use the following procedure.

1. Slide the rubber boot away from the adjuster; then loosen the jam nut (1) from the throttle cable adjuster (2).

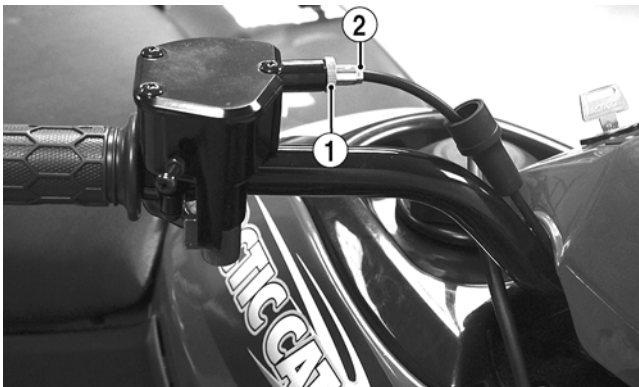

KM111A

2. Turn the adjuster until the throttle cable has proper free-play of 1-4 mm (1/16-3/16 in.) at the lever.

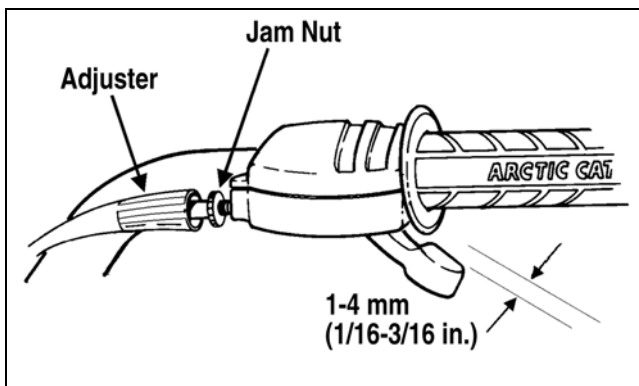

ATV-0047B

1. With the transmission in neutral, start the engine and warm it up to normal operating temperature.
2. Turn the idle adjustment screw clockwise one turn past the recommended RPM setting; then turn it counterclockwise to the correct setting of 1600-1800 RPM.

### **⚠ WARNING**

Adjust the idle to the correct RPM. Make sure the engine is at normal operating temperature before adjusting the idle RPM.

---

---

## Gas Tank

---

### **⚠ WARNING**

Whenever any maintenance or inspection is made on the fuel system during which there may be fuel leakage, there should be no welding, smoking, open flames, etc., in the area.

### REMOVING

1. Turn the gas tank valve to the OFF position.
2. Remove the seat.
3. Disconnect the hose from the carburetor to the gas tank at the carburetor; then remove the gas tank cover.

- Remove the cap screws securing the gas tank to the frame.

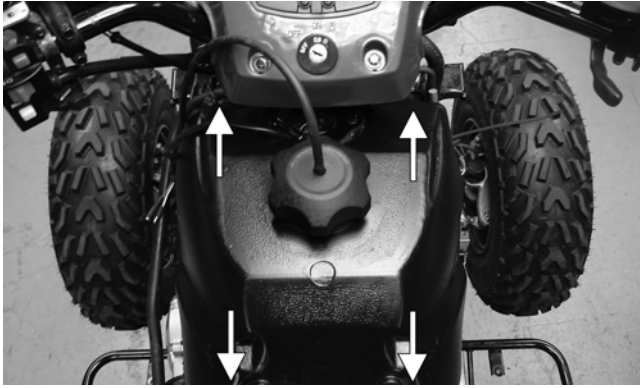

KM327A

- Remove the vent hose; then remove the gas tank.

### CLEANING AND INSPECTING

**NOTE:** Whenever a part is worn excessively, cracked, or damaged in any way, replacement is necessary.

- Clean all gas tank components with parts-cleaning solvent.
- Inspect all hoses for cracks or leaks.
- Inspect gas tank valve, tank cap, and tank for leaks, holes, and damaged threads.
- Inspect the gas gauge for proper operation.

### INSTALLING

- Place the gas tank into position on the frame; then install the cap screws. Tighten securely.
- Connect the gas hose from the carburetor.
- Install the vent hose; then fill the gas tank with gasoline.
- Turn the gas tank valve to the ON position and inspect for leakage.
- Install the seat.

---

## Gas Tank Valve

---

The ATV has a valve attached to the gas tank. There are three positions: ON, RES, and OFF.

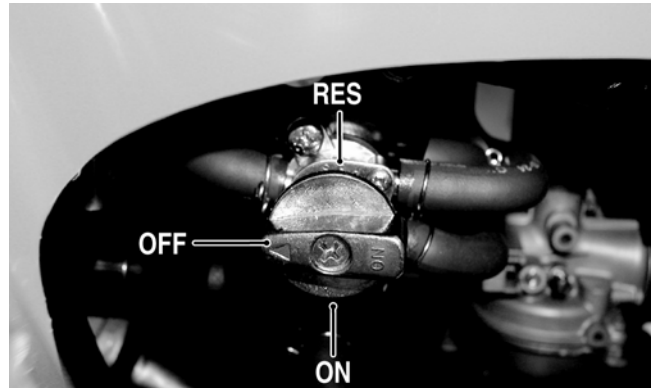

KM043A

In the OFF position, the valve will not allow gasoline to flow to the carburetor. In the ON position (the normal operating position), gasoline will flow from the tank to the carburetor. In this position 4.54 L (1.2 U.S. gal.) will remain in the tank as a reserve quantity. Moving the valve to the RES position will allow the operator to use the remaining gasoline in the tank. When turning the valve to any of the three positions, make sure the indicator is pointed directly at the position desired.

### REMOVING/INSPECTING

#### **WARNING**

**Drain the gas tank prior to this procedure.**

- Remove the gas hose from the valve by releasing the clamp.
- Remove the two machine screws securing the valve; then remove the valve. Account for the gasket.
- Inspect the gasket and valve/tank mating surfaces for damage or deterioration.
- Inspect for and remove any obstructions in the valve.

### INSTALLING

- Place the valve and gasket into position on the tank and secure with the machine screws. Tighten securely.
- Install the gas hose onto the valve with the clamp.

---

## Gas/Vent Hoses

---

Replace the gas hose every two years. Damage from aging may not always be visible. Do not bend or obstruct the routing of the carburetor vent hose. Make sure the vent hose is securely connected to the carburetor and the opposite end is always open.



---

---

## Oil Flow Chart

---

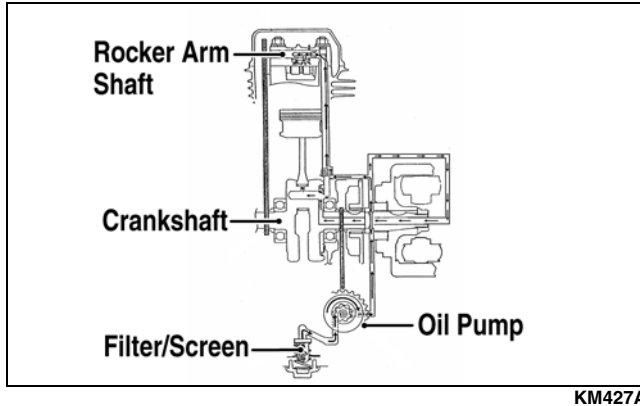

---

---

## Oil Pump

---

■NOTE: Whenever internal engine components wear excessively or break and whenever oil is contaminated, the oil pump should be disassembled, cleaned, and inspected.

■NOTE: The oil pump is not a serviceable component. If the pump is defective, the oil pump must be replaced.

### REMOVING/DISASSEMBLING

1. Remove the oil pump from the engine (see Right-Side Components in Section 3).
2. Remove the Phillips-head screw on the back side of the pump and separate the pump housing and cover. Note the position of the inner and outer rotors and alignment pin for assembly.
3. Remove oil pump components.

### CLEANING AND INSPECTING

■NOTE: If any part is worn excessively, cracked, or damaged in any way, the oil pump must be replaced.

1. Clean all oil pump components.
2. Inspect the rotors for scoring and gouges.
3. Inspect the alignment pin, driveshaft, and driven sprocket for damage.
4. Inspect the pump housing and cover for cracks or damage.

### ASSEMBLING/INSTALLING

1. Place the rotors into the pump housing making sure the alignment pin is in the groove of the rotor.
2. Place the cover onto the pump housing.
3. Secure the pump with the Phillips-head screw coated with red Loctite #271.
4. Install the oil pump into the engine (see Right-Side Components in Section 3).

## Troubleshooting

<b>Problem: Starting impaired</b>	
<b>Condition</b>	<b>Remedy</b>
<ol style="list-style-type: none"> <li>1. <b>Slow jet</b> obstructed</li> <li>2. <b>Slow jet passage</b> obstructed</li> <li>3. <b>Carburetor</b> leaking air</li> <li>4. <b>Choke valve</b> not operating properly</li> </ol>	<ol style="list-style-type: none"> <li>1. Clean jet</li> <li>2. Clean passage</li> <li>3. Tighten - adjust - replace gasket</li> <li>4. Check - adjust choke/choke cable</li> </ol>
<b>Problem: Idling or low speed impaired</b>	
<b>Condition</b>	<b>Remedy</b>
<ol style="list-style-type: none"> <li>1. <b>Slow jet</b> obstructed - loose</li> <li>2. <b>Slow jet outlet</b> obstructed</li> <li>3. <b>Pilot screw setting</b> incorrect</li> <li>4. <b>Choke valve</b> not fully open</li> <li>5. <b>Float height</b> incorrect</li> </ol>	<ol style="list-style-type: none"> <li>1. Clean - tighten jet</li> <li>2. Clean outlet</li> <li>3. Adjust screw</li> <li>4. Adjust choke</li> <li>5. Adjust float height</li> </ol>
<b>Problem: Medium or high speed impaired</b>	
<b>Condition</b>	<b>Remedy</b>
<ol style="list-style-type: none"> <li>1. <b>High RPM "cut out"</b> against RPM limiter</li> <li>2. <b>Main jet</b> obstructed</li> <li>3. <b>Needle jet</b> obstructed</li> <li>4. <b>Filter</b> obstructed</li> <li>5. <b>Float height</b> incorrect</li> <li>6. <b>Starter valve</b> not fully open</li> </ol>	<ol style="list-style-type: none"> <li>1. Shift into higher gear - decrease RPM speed</li> <li>2. Clean main jet</li> <li>3. Clean needle jet</li> <li>4. Clean filter</li> <li>5. Adjust float height</li> <li>6. Adjust choke/choke cable</li> </ol>
<b>Problem: Overflow and fuel level fluctuations</b>	
<b>Condition</b>	<b>Remedy</b>
<ol style="list-style-type: none"> <li>1. <b>Float valve</b> worn - damaged</li> <li>2. <b>Float valve spring</b> broken</li> <li>3. <b>Float</b> fuel logged</li> <li>4. <b>Float valve</b> dirty</li> <li>5. <b>Float height</b> too high - too low</li> </ol>	<ol style="list-style-type: none"> <li>1. Replace valve</li> <li>2. Replace spring</li> <li>3. Replace float</li> <li>4. Clean valve</li> <li>5. Adjust float height</li> </ol>

4

# SECTION 5 - ELECTRICAL SYSTEM

---

---

## TABLE OF CONTENTS

---

Electrical System.....	5-2
Specifications .....	5-2
RPM Limiter .....	5-2
Testing Electrical Components.....	5-2
Electrical Connections.....	5-2
Switches.....	5-2
Battery.....	5-3
Brakelight Switch (Front Brake).....	5-4
Brakelight Switch (Rear Brake) .....	5-4
Fuse Holder.....	5-4
Ignition Coil .....	5-5
LCD Gauge Assembly.....	5-5
Ignition Switch .....	5-6
Handlebar Control Switches.....	5-7
Magneto Coils .....	5-7
Starter Motor .....	5-8
Starter Relay .....	5-8
CDI Unit.....	5-9
Regulator/Rectifier .....	5-9
Start-in-Gear Relay .....	5-9
Headlights .....	5-10
Taillight - Brakelight .....	5-10
Ignition Timing.....	5-11
Troubleshooting.....	5-11

## Electrical System

This section has been organized into sub-sections which show procedures for the complete servicing of the Arctic Cat ATV electrical system.

**NOTE:** Some photographs and illustrations used in this section are used for clarity purposes only and are not designed to depict actual conditions.

### SPECIAL TOOLS

A number of special tools must be available to the technician when performing service procedures in this section. Refer to the current Special Tools Catalog for the appropriate tool description.

Description	p/n
Fluke Model 77 Multimeter	0644-559
MaxiClips	0744-041
Peak Voltage Reading Adapter	0644-307
Tachometer	0644-275
Timing Light	0644-296

**NOTE:** Special tools are available from the Arctic Cat Service Parts Department.

## Specifications

IGNITION	
Ignition Timing	15° BTDC ("F" mark) @ 1700 RPM
Spark Plug Type	NGK DR8EA
Spark Plug Gap	0.6 mm (0.024 in.)
Spark Plug Cap	4200-5200 ohms
Ignition Coil Resistance (primary)	0.2-0.3 ohms (terminal to ground)
(secondary)	3200-4800 ohms (high tension to ground)
Ignition Coil Peak Voltage (primary/CDI)	85 DC volts (black to ground)
MAGNETO	
Magneto Coil Resistance (trigger)	105-110 ohms (blue to green)
(charging)	Less than 1 ohm (yellow to yellow)
(signal)	720 ohms (black to ground)
Peak Voltage (trigger)	1.1-1.4 DC volts (blue to green)
(signal)	220 DC volts (black to ground)
Magneto Output (approx)	220W @ 5000 RPM
Charging Coil Output (no load)	40-60 AC volts @ 3500 RPM (yellow to yellow)

## RPM Limiter

**NOTE:** The ATV is equipped with a CDI unit that retards ignition timing when maximum RPM is approached. When the RPM limiter is activated, it could be misinterpreted as a high-speed misfire.

## Testing Electrical Components

All of the electrical tests should be made using the Fluke Model 77 Multimeter and when testing peak voltage, the Peak Voltage Reading Adapter must be used. If any other type of meter is used, readings may vary due to internal circuitry. When troubleshooting a specific component, always verify first that the fuse(s) are good, that the bulb(s) are good, that the connections are clean and tight, that the battery is fully charged, and that all appropriate switches are activated.

**NOTE:** For absolute accuracy, all tests should be made at room temperature of approximately 68° F.

## Electrical Connections

The electrical connections should be checked periodically for proper function. In case of an electrical failure, check fuses, connections (for tightness, corrosion, damage), and/or bulbs.

## Switches

Each time the ATV is used, switches should be checked for proper operation. Use the following list for reference.

- A. Ignition switch — engine will start.
- B. Emergency stop switch — engine will stop.
- C. Reverse switch — reverse indicator light will illuminate.
- D. Hi/Lo switch — headlight high beam or low beam will illuminate.
- E. Brake switches — rear brakelight will illuminate.

## Battery

The battery is located under the seat.

After being in service, batteries require regular cleaning and recharging in order to deliver peak performance and maximum service life. The following procedure is recommended for cleaning and maintaining a sealed battery. Always read and follow instructions provided with battery chargers and battery products.

### WARNING

Anytime service is performed on a battery, the following must be observed: keep sparks, open flame, cigarettes, or any other flame away. Always wear safety glasses. Protect skin and clothing when handling a battery. When servicing battery in enclosed space, keep the area well-ventilated.

1. Remove the battery hold-down; then disconnect the battery cables (negative cable first).
2. Remove the battery from the battery compartment; then thoroughly wash the battery and battery compartment with soap and water.

■NOTE: If battery posts, cable ends, or the battery case has a build-up of white/green powder residue, apply water and baking soda to neutralize acid; then flush off with warm soapy water.

3. Using a wire brush, clean the battery posts and cable ends removing all corrosive buildup. Replace damaged cables or cable ends.

### CAUTION

Do not remove seal strip.

### WARNING

Battery acid is harmful if it contacts eyes, skin, or clothing. Care must be taken whenever handling a battery.

4. Using a multimeter, test the battery voltage. The meter must read at least 12.5 DC Volts for a fully charged battery.

■NOTE: At this point if the meter reads as specified, the battery may be returned to service (see step 8).

5. If the meter reads less than specified voltage, charge the battery using the following guidelines.

A. When using an automatic battery charger, always follow the charger manufacturer's instructions.

B. When using a constant-current battery charger, use the following Battery Charging Chart.

### CAUTION

Never exceed the standard charging rate.

### WARNING

An overheated battery could explode causing severe injury or death. Always monitor charging times and charge rates carefully. Stop charging if the battery becomes very warm to the touch. Allow it to cool before resuming charging.

#### Battery Charging Chart (Constant-Current Charger)

Battery Voltage (DC)	Charge State	Charge Time Required (at 1.5-2.0 Amps)
12.5 or more	100%	None
12.2-12.4	75%-99%	3-6 hours
12.0-12.2	50%-74%	5-11 hours
11.0-11.9	25%-49%	13 hours (minimum)
11.5 or less	0-24%	20 hours (minimum)

■NOTE: If the battery voltage is 11.5 DC Volts or less, some chargers may “cut off” and fail to charge. If this occurs, connect a fully charged booster battery in parallel (positive to positive and negative to negative) for a short period of time with the charger connected. After 10-15 minutes, disconnect the booster battery leaving the charger connected and the charger should continue to charge. If the charger “cuts off,” replace the battery.

6. After charging the battery for the specified time, remove the battery charger and allow the battery to sit for 1-2 hours.
7. Connect the multimeter and test the battery voltage. The meter should read at least 12.5 DC Volts. If the voltage is as specified, the battery is ready for service.

■NOTE: If voltage in step 7 is below specifications, charge the battery an additional 1-5 hours; then retest.

8. Place the battery in the battery compartment; then coat the battery posts and cable ends with a light coat of multi-purpose grease.

### CAUTION

Before installing the battery, make sure the ignition switch is in the OFF position.

9. Connect the battery cables (positive cable first); then install the battery hold-down.

### CAUTION

Connecting cables in reverse (positive to negative and negative to positive) can cause serious damage to the electrical system.

## Brakelight Switch (Front Brake)

The switch pigtail connects to the main wiring harness with two separate bullet-type connectors directly in front of the upper steering shaft bearing.



TR228

■NOTE: The ignition switch must be in the ON position.

### VOLTAGE (Wiring Harness Side)

1. Set the meter selector to the DC Voltage position.
2. Connect the red tester to the black wire; then connect the black tester lead to ground.
3. The meter must show battery voltage.

■NOTE: If the meter shows no battery voltage, troubleshoot the battery, fuse, switch, or the main wiring harness.

■NOTE: If the meter shows battery voltage, the main wiring harness is good; proceed to test the switch/component, the connector, and the switch wiring harness for resistance.

### RESISTANCE (Switch Connector)

#### CAUTION

Always disconnect the battery when performing resistance tests to avoid damaging the multimeter.

1. Set the meter selector to the OHMS position.
2. Connect the red tester lead to the black wire; then connect the black tester lead to the green/yellow wire.
3. When the brake lever is compressed, the meter must show less than 1 ohm.

■NOTE: If the meter shows more than 1 ohm of resistance, replace the switch.

## Brakelight Switch (Rear Brake)

The switch has spade-type connectors which engage the harness connectors at the switch.

■NOTE: The ignition switch must be in the ON position.

### VOLTAGE (Wiring Harness Connector)

1. Set the meter selector to the DC Voltage position.
2. Connect the red tester lead to the black wire; then connect the black tester lead to ground.
3. The meter must show battery voltage.

■NOTE: If the meter shows no battery voltage, troubleshoot the battery, fuse, switch, or the main wiring harness.

■NOTE: If the meter shows battery voltage, the main wiring harness is good; proceed to test the switch/component, the connector, and the switch wiring harness for resistance.

### RESISTANCE (Switch)

#### CAUTION

Always disconnect the battery when performing resistance tests to avoid damaging the multimeter.

■NOTE: The brake lever must be compressed for this test. Also, the ignition switch must be in the OFF position.

1. Set the meter selector to the OHMS position.
2. Connect the red tester lead to one spade terminal; then connect the black tester lead to the other spade terminal.
3. When the lever is compressed, the meter must show less than 1 ohm.

■NOTE: If the meter shows more than 1 ohm of resistance, replace the switch.

## Fuse Holder

The main (20 amp) fuse is located under the batter cover under the seat.

■NOTE: To remove the fuse, compress the locking tabs on either side of the fuse case and lift out.

If the fuse is blown, the fuse element will be visibly burned and separated. Attempt to determine the cause of the blown fuse and install a new fuse of the same amperage.

### CAUTION

Always replace a blown fuse with a fuse of the same type and rating. Replacing a blown fuse with a different rating can cause severe electrical wiring damage or fire could occur.

## Ignition Coil

The ignition coil is on the right side of the frame in front of the engine.

### PEAK VOLTAGE (Primary/CDI Side)

■NOTE: All of the peak voltage tests should be made using the Fluke Model 77 Multimeter with Peak Voltage Reading Adapter. If any other type of tester is used, readings may vary due to internal circuitry.

■NOTE: The battery must be at full charge for these tests.

■NOTE: The ignition switch must be in the ON position; the emergency stop switch must be in the RUN position. Also, the black wire must be disconnected from the coil.

1. Set the meter selector to the DC Voltage position.
2. Connect the red tester lead to the black/white wire; then connect the black tester lead to the green/gray wire.
3. The meter reading must show greater than 85 volts.

■NOTE: If the voltage is not as specified in the above test, inspect the main wiring harness, main fuse, ignition switch, or engine stop switch.

### RESISTANCE

### CAUTION

Always disconnect the battery when performing resistance tests to avoid damaging the multimeter.

■NOTE: For these tests, the meter selector must be set to the OHMS position.

### Primary Winding

1. Remove the primary connector from the coil; then connect the red tester lead to the primary terminal and the black tester lead to ground.
2. The meter reading must be within specification.

### Secondary Winding

1. Connect the red tester lead to the high tension lead; then connect the black tester lead to ground.
2. The meter reading must be within specification.

■NOTE: If the meter does not show as specified, replace ignition coil.

### Spark Plug Cap

1. Connect the red tester lead to one end of the cap; then connect the black tester lead to the other end of the cap.

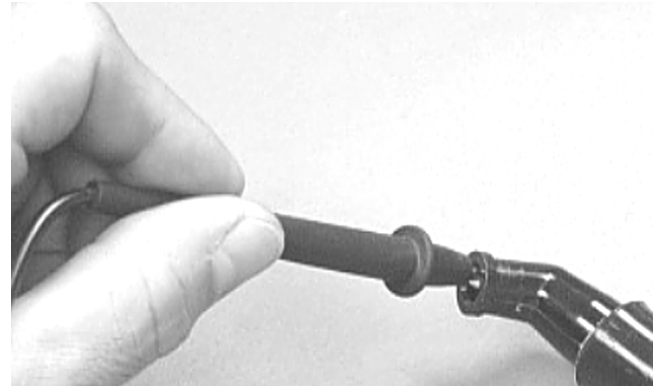

AR603D

2. The meter reading must be within specification.

■NOTE: If the meter does not read as specified, replace the spark plug cap.

5

## LCD Gauge Assembly

### REMOVING

To remove the LCD gauge assembly, see Section 8 of this manual.

### TESTING

■NOTE: If any functions (segments or displays) are not normal or do not display as indicated, the LCD gauge must be replaced.

1. Remove the instrument pod. Leave the gauge connected to the wiring harness.

■NOTE: To perform the following tests, two MaxiClips and one jumper wire will be required.

2. Connect the black MaxiClip to the green wire.
3. Connect the red MaxiClip to the light green/red wire; then connect the jumper between the MaxiClips and turn the ignition switch to the ON position. The neutral indicator light (7) must illuminate.



KM842D

4. Connect the red MaxiClip to the blue/red wire. The reverse indicator light (6) must illuminate.
5. Connect the red MaxiClip to the yellow/white wire and the black MaxiClip to the lavender/white wire. The fuel quantity indicator (4) must sequence from empty to full; then all segments will disappear and the gas pump icon (8) will begin flashing.
6. Connect the red MaxiClip to the blue wire; then connect a voltmeter to the MaxiClips (red meter lead to red and black meter lead to black).
7. Set the meter selector to the DC Voltage position; then turn the ignition switch to the LIGHTS position and the light control switch to the HI beam position. The tester must indicate battery voltage and the high beam indicator light (5) must illuminate. If the tester does not read battery voltage, troubleshoot the ignition switch, light control switch, or wiring harness and connectors.
8. Connect the red MaxiClip to the brown/black wire. The tester must read battery voltage and the speedometer backlight must illuminate. If the tester does not read battery voltage, troubleshoot the ignition switch or wiring harness connectors.
9. Depress and hold the Mode/Set button (A). The speedometer should switch between mph and km/h as indicated by icon (9).
10. Depress and hold the Mode/Set button (B). The distance mode should shift between ODO and TRIP as indicated by icon (2).
11. Depress and hold the Mode/Set buttons (A) and (B) simultaneously. The hour segment of the clock should flash indicating the clock (3) is in the set mode. Release the Mode/Set button (A) and release (B) when the desired hour (1-24) appears.
12. Depress and release the Mode/Set button (A) to shift the clock set to the minute segment; then depress Mode/Set button (B) to set the desired minute.

■NOTE: In the clock set mode, the gauge will default to normal operation 10 seconds after the Mode/Set buttons are released.

13. With the ignition switch in the ON position, elevate the rear wheels and rotate them several revolutions in either direction. The speed indicator LCD (1) should indicate a value less than zero.

## INSTALLING

To install the LCD gauge assembly, see Section 8 of this manual.

## Ignition Switch

The connector is the white one in front of the steering post.

### VOLTAGE

■NOTE: Perform this test on the lower side of the connector.

1. Set the meter selector to the DC Voltage position.
2. Connect the red meter lead to the red wire; then connect the black meter lead to ground.
3. The meter must show battery voltage.

■NOTE: If the meter shows no battery voltage, troubleshoot the battery, main fuse, or the main wiring harness.

### RESISTANCE

#### CAUTION

Always disconnect the battery when performing resistance tests to avoid damaging the multimeter.

■NOTE: Perform this test on the upper side of the connector.

1. Turn the ignition switch to the ON position.
2. Set the meter selector to the OHMS position.
3. Connect the red tester lead to the red wire; then connect the black tester lead to the black wire.
4. The meter must show less than 1 ohm.
5. With the red tester lead connected to the red wire, connect the black tester lead to the black/white wire.
6. The meter must show less than 1 ohm.
7. Turn the ignition switch to the LIGHTS position.
8. Connect the red tester lead to the red wire; then connect the black tester lead to the brown wire.
9. The meter must show less than 1 ohm.

■NOTE: If the meter shows more than 1 ohm of resistance, replace the switch.



## Handlebar Control Switches

Two white connectors join the handlebar control switch pigtail to the main harness.

The connectors are located in front of the steering post.

■NOTE: These tests should be made on the switch side of the connectors with the connectors uncoupled.

### CAUTION

Always disconnect the battery when performing resistance tests to avoid damaging the multimeter.

### RESISTANCE (HI Beam)

1. Set the meter selector to the OHMS position.
2. Connect the red tester lead to the lavender wire; then connect the black tester lead to the brown/black wire.
3. With the dimmer switch in the HI position, the meter must show less than 1 ohm.

■NOTE: If the meter shows more than 1 ohm of resistance, troubleshoot or replace the switch/component or the connector.

### RESISTANCE (LO Beam)

1. Connect the red tester lead to the white wire.
2. With the dimmer switch in the LO position, the meter must show less than 1 ohm.

■NOTE: If the meter reads more than 1 ohm of resistance, troubleshoot or replace the switch/component or the connector.

### RESISTANCE (Starter Button)

1. Set the meter selector to the OHMS position.
2. Connect the red tester lead to the black/white wire; then connect the black tester lead to the yellow/red wire.
3. With the starter button depressed, the meter must show less than 1 ohm.
4. With the starter button released, the meter must show an open circuit.

■NOTE: If the meter does not show as specified, replace the switch/component or connector.

### RESISTANCE (Emergency Stop)

1. Set the meter selector to the OHMS position.

2. Connect the red tester lead to the brown/blue wire; then connect the black tester lead to the black/white wire.
3. With the switch in the OFF position, the meter must show an open circuit.
4. With the switch in the RUN position, the meter must show less than 1 ohm.

■NOTE: If the meter shows more than 1 ohm of resistance, troubleshoot or replace the switch/component or the connector.

### RESISTANCE (Reverse Override)

1. Set the meter selector to the OHMS position.
2. Connect the red tester lead to the green/red wire; then connect the black tester lead to the blue/red wire. The meter must show an open circuit.
3. Depress and hold the reverse override button. The meter must show less than 1 ohm of resistance.

■NOTE: If the meter does not show as specified, replace the switch/component or connector.

## Magneto Coils

5

### VOLTAGE (Charging Coil - Output)

1. Set the meter selector to the DC Voltage position.
2. Connect the red tester lead to the positive battery post; then connect the black tester lead to the negative battery post.
3. With the engine running at a constant 5000 RPM (with the headlights on), the meter must show 14-15.5 DC volts.

### CAUTION

Do not run the engine at high RPM for more than 10 seconds.

■NOTE: If voltage is lower than specified, test charging coil - no load.

### VOLTAGE (Charging Coil - No Load)

The connector is the black and white one on the right rear side of the frame just above the regulator/rectifier.

■NOTE: Test the connector that comes from the engine.

1. Set the meter selector to the AC Voltage position.
2. Test between the three yellow wires for a total of three tests.

3. With the engine running at the specified RPM, all wire tests must show as specified.

### CAUTION

Do not run the engine at high RPM for more than 10 seconds.

■NOTE: If both voltage tests failed, check all connections, etc., and test again. If no voltage is present, replace the stator assembly.

### RESISTANCE (Charging Coil)

### CAUTION

Always disconnect the battery when performing resistance tests to avoid damaging the multimeter.

1. Set the meter selector to OHMS position.
2. Test between the three yellow wires for a total of three tests.
3. The meter reading must be within specification.

### RESISTANCE (Trigger Coil)

### CAUTION

Always disconnect the battery when performing resistance tests to avoid damaging the multimeter.

The trigger coil connector is located under the seat at the rear of the air filter housing.

1. Set the meter selector to the OHMS position.
2. Connect the red tester lead to the blue wire; then connect the black tester lead to the green wire. The meter reading must be within specification.

### RESISTANCE (Signal Coil)

The signal coil connector is located under the seat at the rear of the air filter housing.

1. Set the meter selector to the OHMS position.
2. Connect the red tester lead to the black wire; then connect the black tester lead to ground. The meter reading must be within specifications.

### PEAK VOLTAGE

■NOTE: All of the peak voltage tests should be made using the Fluke Model 73 Multimeter with Peak Voltage Reading Adapter. If any other type of tester is used, readings may vary due to internal circuitry.

■NOTE: The battery must be at full charge for these tests.

### Trigger Coil

1. Set the meter selector to the DC Voltage position.
2. Connect the red tester lead to the blue wire; then connect the black tester lead to the green wire.

3. Crank the engine over using the electric starter.
4. The meter reading must be within specification.

### Signal Coil

1. Set the meter selector to the DC Voltage position.
2. Connect the red tester lead to the black wire (engine side); then connect the black tester lead to a suitable ground.
3. Crank the engine over using the electric starter.
4. The meter reading must be within specifications.

---

---

## Starter Motor

---

■NOTE: The starter motor is not a serviceable component. If the starter motor does not operate, see Starter Relay in this section. If the relay tests normal, replace the starter motor.

### REMOVING/INSTALLING

1. Disconnect the battery.

### CAUTION

Always disconnect the negative battery cable from the battery first; then disconnect the positive cable.

2. Remove the nut securing the positive cable to the starter; then remove the cable from the starter.
3. Remove the two cap screws securing the starter to the crankcase; then remove the starter. Account for the wiring forms and an O-ring.
4. Install the new starter motor; then tighten the cap screws to 7 ft-lb.
5. Secure the starter lead to the starter with the nut. Tighten to 36 in.-lb.

---

---

## Starter Relay

---

### VOLTAGE

1. Set the meter selector to the DC Voltage position.
2. Connect the red tester lead to the battery supply terminal (1); then connect the black lead to the starter terminal (2).

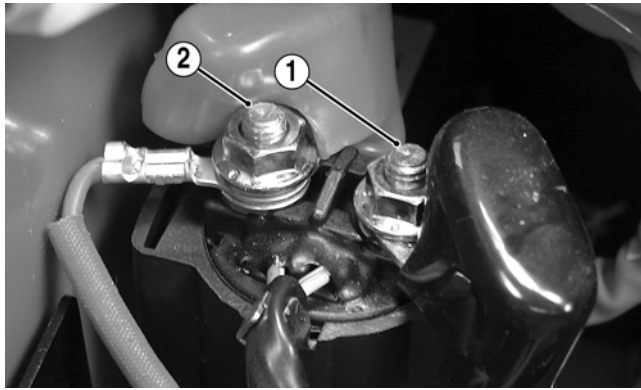

KM458A

- Turn the ignition switch to the ON position. The meter must read battery voltage.

■**NOTE:** If battery voltage is not shown on the meter, troubleshoot the battery connections, ground connections, and starter cable connections.

- With the transmission in neutral, depress the starter button. There should be an audible “click” from the starter relay and the meter should show 0 DC volts. If the meter indicates as specified, replace the starter. If there is no audible click and meter reads battery voltage, proceed to step 5.
- Disconnect the two-wire connector on the starter relay pigtail from the main harness; then on the harness side, connect the red tester lead to the yellow/red wire and the black tester lead to the yellow/green wire.
- With the transmission in neutral, depress the starter button. The meter must read battery voltage. If battery voltage is indicated, replace the starter solenoid. If no voltage is indicated, troubleshoot the gear position switch, starter button, ignition switch, or harness connectors.

---

## CDI Unit

---

The CDI is located beneath the seat at the rear of the gas tank.

■**NOTE:** The CDI unit is not a serviceable component. If the unit is defective, it must be replaced.

The CDI is rarely the cause for electrical problems; however, if the CDI is suspected, substitute another CDI unit to verify the suspected one is defective.

■**NOTE:** Prior to replacing the CDI unit to assure the CDI unit is defective, it is advisable to perform a CDI peak voltage test (see Ignition Coil in this section) and/or perform a continuity test of the wiring harness from the CDI connector to the CDI unit.

---

## Regulator/Rectifier

---

The regulator/rectifier is located on the right side of the frame above the rear wheel. Verify all other charging system components before the regulator/rectifier is replaced.

### TESTING

- Start the engine and warm up to normal operating temperature; then connect a multimeter to the battery as follows.
- Select the DC Voltage position; then connect the red tester lead to the positive battery post and the black tester lead to the negative battery post.
- Start the engine and slowly increase RPM. The voltage should increase with the engine RPM to a maximum of 15.5 DC volts.

■**NOTE:** If voltage rises above 15.5 DC volts, the regulator is faulty or a battery connection is loose or corroded. Clean and tighten battery connections or replace the regulator/rectifier. If voltage does not rise, check Voltage (Stator Coil - No Load) sub-section. If charging coil voltage is normal, replace the regulator/rectifier.

5

---

## Start-in-Gear Relay

---

■**NOTE:** The relay schematic is embossed on the relay housing for testing continuity.

■**NOTE:** The module and wiring harness are not a serviceable component and must be replaced as an assembly.

### TESTING

The start-in-gear relay is located under the seat below the fuse block. To test the relay, use the following procedure.

- Turn the ignition switch to the ON position; then compress the brake lever or depress the auxiliary brake pedal. There should be an audible “click” from the start-in-gear relay.

■**NOTE:** The brakelight should illuminate whenever either brake is applied. If the brakelight does not illuminate, troubleshoot the respective brakelight switch.

- Apply the opposite brake from step 1. There should be an audible “click” from the start-in-gear relay.

3. Disconnect the four-wire connector from the start-in-gear relay; then using a voltmeter, connect the red tester lead to the green/yellow wire (1) and the black tester lead to the green wire (3).

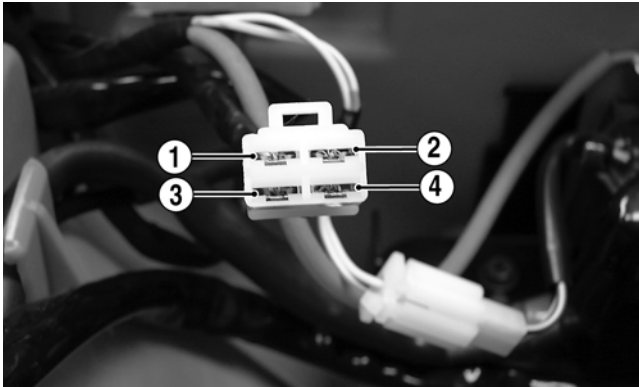

KM460A

4. With the ignition switch in the ON position, select the DC volts position on the tester; then apply either brake. The meter must read battery voltage. If battery voltage is observed and no audible “click” was heard in step 1 or 2, remove the tester leads and replace the start-in-gear relay.
5. Shift the gear selector out of neutral and connect a jumper wire between the yellow/green wire (2) and the green wire (4).

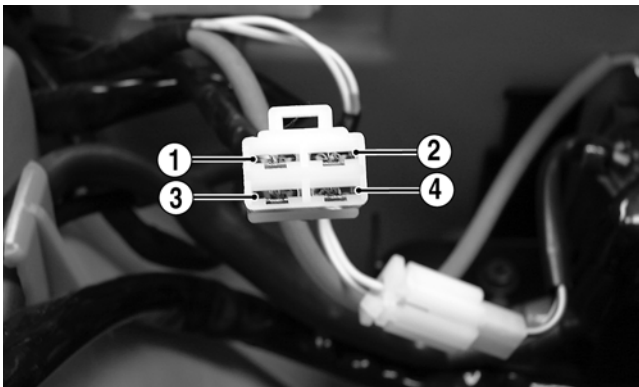

KM460A

6. Momentarily depress the starter button. The starter should engage. If the starter engages, replace the start-in-gear relay. If the starter does not engage, troubleshoot the battery connections, starter relay, or starter connections.

---



---

## Headlights

---

The connectors are the two 3-prong ones secured to the front bumper supports (one on each side) with cable ties.

### BULB VERIFICATION (LO and HI Beam)

Visually inspect the bulb for broken filaments, blackening, or loose bulb base.

### VOLTAGE

■NOTE: Perform this test in turn on the main harness side of the connectors. Also, the ignition switch must be in the LIGHTS position and the engine must be running.

1. Set the meter selector to the DC Voltage position.
2. Connect the red tester lead to the green wire; then connect the black tester lead to the white wire.
3. With the dimmer switch in the LO position (LO beam), the meter must show battery voltage.
4. Connect the red tester lead to the blue wire. With the dimmer switch in the HI position (HI beam), the meter must show battery voltage.

■NOTE: If battery voltage is not shown in any test, inspect the fuses, battery, main wiring harness, connectors, or the left handlebar switch.

---



---

## Taillight - Brakelight

---

The connector is the 3-prong one located under the rear fender assembly.

### BULB VERIFICATION

Visually inspect the bulb for broken filaments, blackening, or loose bulb base.

### VOLTAGE (Taillight)

■NOTE: Perform this test on the main harness side of the connector. Also, the ignition switch should be in the LIGHTS position.

1. Set the meter selector to the DC Voltage position.
2. Connect the red tester lead to the brown/black wire; then connect the black tester lead to the green wire.
3. With the ignition key in the LIGHTS position, the meter must show battery voltage.

■NOTE: If the meter shows no voltage, inspect fuses, wiring harness, connectors, and switches.

### VOLTAGE (Brakelight)

■NOTE: Perform this test on the main harness side of the connector. Also, the ignition switch should be in the ON position and the brake (either foot pedal or hand lever) must be applied.

1. Set the meter selector to the DC Voltage position.
2. Connect the red tester lead to the green/yellow wire; then connect the black tester lead to the green wire.

3. With either brake applied, the meter must show battery voltage.

■NOTE: If the meter shows no voltage, inspect fuses, wiring harness, connectors, and switches.

## Ignition Timing

The ignition timing cannot be adjusted; however, verifying ignition timing can aid in troubleshooting other components. To verify ignition timing, use the following procedure.

1. Attach the Timing Light to the spark plug high tension lead; then remove the timing inspection plug from the left-side crankcase cover.
2. Using the Tachometer, start the engine and run at 1700 RPM; ignition timing should be 15° BTDC ("F" mark).
3. Install the timing inspection plug.

If ignition timing cannot be verified, the rotor may be damaged, the key may be sheared, the trigger coil bracket may be bent or damaged, or the CDI unit may be faulty.

## Troubleshooting

Problem: Spark absent or weak	
Condition	Remedy
<ol style="list-style-type: none"> <li>1. Ignition coil defective</li> <li>2. Spark plug defective</li> <li>3. Trigger coil defective</li> <li>4. CDI unit defective</li> <li>5. Pick-up coil defective</li> </ol>	<ol style="list-style-type: none"> <li>1. Replace ignition coil</li> <li>2. Replace plug</li> <li>3. Replace stator coil assembly</li> <li>4. Replace CDI unit</li> <li>5. Replace stator coil assembly</li> </ol>
Problem: Spark plug fouled with carbon	
Condition	Remedy
<ol style="list-style-type: none"> <li>1. Mixture too rich</li> <li>2. Idling RPM too low</li> <li>3. Gasoline incorrect</li> <li>4. Air cleaner element dirty</li> <li>5. Spark plug incorrect (too cold)</li> <li>6. Valve seals cracked - missing</li> <li>7. Oil rings worn - broken</li> </ol>	<ol style="list-style-type: none"> <li>1. Adjust carburetor</li> <li>2. Adjust carburetor</li> <li>3. Change to correct gasoline</li> <li>4. Clean element</li> <li>5. Replace plug</li> <li>6. Replace seals</li> <li>7. Replace rings</li> </ol>
Problem: Spark plug electrodes overheat or burn	
Condition	Remedy
<ol style="list-style-type: none"> <li>1. Spark plug incorrect (too hot)</li> <li>2. Engine overheats</li> <li>3. Spark plug loose</li> <li>4. Mixture too lean</li> </ol>	<ol style="list-style-type: none"> <li>1. Replace plug</li> <li>2. Check engine oil - clean cooling fans</li> <li>3. Tighten plug</li> <li>4. Change jets</li> </ol>
Problem: AC generator does not charge	
Condition	Remedy
<ol style="list-style-type: none"> <li>1. AC generator lead wires/connections shorted - loose - open</li> <li>2. AC generator coils shorted - grounded - open</li> <li>3. Regulator/rectifier defective</li> </ol>	<ol style="list-style-type: none"> <li>1. Repair - replace - tighten lead wires</li> <li>2. Replace stator coils</li> <li>3. Replace regulator/rectifier</li> </ol>
Problem: AC generator charges, but charging rate is below the specification	
Condition	Remedy
<ol style="list-style-type: none"> <li>1. Lead wires shorted - open - loose (at terminals)</li> <li>2. AC generator coils (charging) grounded - open</li> <li>3. Regulator/rectifier defective</li> <li>4. Cell plates (battery) defective</li> </ol>	<ol style="list-style-type: none"> <li>1. Repair - tighten lead wires</li> <li>2. Replace stator coils</li> <li>3. Replace regulator/rectifier</li> <li>4. Replace battery</li> </ol>

<b>Problem: Magneto overcharges</b>	
<b>Condition</b>	<b>Remedy</b>
<ol style="list-style-type: none"> <li>1. <b>Internal battery</b> short circuited</li> <li>2. <b>Regulator/rectifier</b> defective</li> <li>3. <b>Regulator/rectifier</b> poorly grounded</li> </ol>	<ol style="list-style-type: none"> <li>1. Replace battery</li> <li>2. Replace regulator/rectifier</li> <li>3. Clean - tighten ground connection</li> </ol>
<b>Problem: Charging unstable</b>	
<b>Condition</b>	<b>Remedy</b>
<ol style="list-style-type: none"> <li>1. <b>Lead wire</b> intermittently shorting</li> <li>2. <b>AC generator</b> internally shorted</li> <li>3. <b>Regulator/rectifier</b> defective</li> </ol>	<ol style="list-style-type: none"> <li>1. Replace lead wire</li> <li>2. Replace magneto</li> <li>3. Replace regulator/rectifier</li> </ol>
<b>Problem: Starter button not effective</b>	
<b>Condition</b>	<b>Remedy</b>
<ol style="list-style-type: none"> <li>1. <b>Battery charge</b> low</li> <li>2. <b>Switch contacts</b> defective</li> <li>3. <b>Starter motor brushes</b> not seating</li> <li>4. <b>Starter relay</b> defective</li> <li>5. <b>Emergency stop - ignition switch</b> off</li> <li>6. <b>Wiring connections</b> loose - disconnected</li> <li>7. <b>Starter bushings</b> worn</li> <li>8. <b>Starter armature</b> shorted - open</li> <li>9. <b>Brake switch</b> defective</li> </ol>	<ol style="list-style-type: none"> <li>1. Recharge - replace battery</li> <li>2. Replace switch</li> <li>3. Repair - replace brushes</li> <li>4. Replace relay</li> <li>5. Turn on switches</li> <li>6. Connect - tighten - repair connections</li> <li>7. Replace starter</li> <li>8. Replace starter</li> <li>9. Replace switch</li> </ol>
<b>Problem: Battery "sulfation" (Acidic white powdery substance or spots on surfaces of cell plates)</b>	
<b>Condition</b>	<b>Remedy</b>
<ol style="list-style-type: none"> <li>1. <b>Charging rate</b> too low - too high</li> <li>2. <b>Specific gravity</b> too low</li> <li>3. <b>Battery</b> run-down - damaged</li> <li>4. <b>Electrolyte</b> contaminated</li> </ol>	<ol style="list-style-type: none"> <li>1. Replace battery</li> <li>2. Charge battery</li> <li>3. Replace battery</li> <li>4. Replace battery</li> </ol>
<b>Problem: Battery discharges too rapidly</b>	
<b>Condition</b>	<b>Remedy</b>
<ol style="list-style-type: none"> <li>1. <b>Electrolyte</b> contaminated</li> <li>2. <b>Battery</b> short-circuited</li> </ol>	<ol style="list-style-type: none"> <li>1. Replace battery</li> <li>2. Replace battery</li> </ol>

# SECTION 6 - DRIVE SYSTEM

---

---

## TABLE OF CONTENTS

---

Drive System .....	6-2
Rear Drive Axle .....	6-2
Troubleshooting Drive System.....	6-4

## Drive System

■NOTE: Some photographs and illustrations used in this section are used for clarity purposes only and are not designed to depict actual conditions.

■NOTE: Critical torque specifications are located in Section 1.

### SPECIAL TOOLS

A number of special tools must be available to the technician when performing service procedures in this section. Refer to the current Special Tools Catalog for the appropriate tool description.

Description	p/n
Pivot Lock Nut Wrench	0444-201
Rear Axle Nut Wrench	0444-198
Pinion Gear Bearing Nut Wrench	0444-203
Pinion Puller	0444-202
V Blocks	0644-022

■NOTE: Special tools are available from the Arctic Cat Service Parts Department.

## Rear Drive Axle

### REMOVING

1. Secure the ATV on a support stand to elevate the rear wheels; then remove the rear wheels.

#### WARNING

Make sure the ATV is solidly supported on the support stand to avoid injury.

2. Remove the hub caps; then remove and discard the cotter pins.

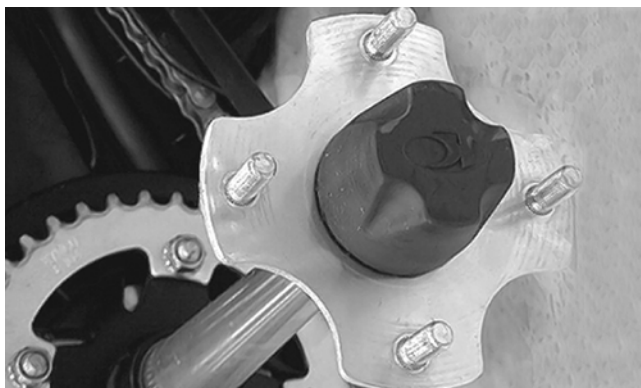

KM464

3. Remove the rear wheel hubs; then remove the brake caliper and lay aside.

■NOTE: Do not apply pressure to the brake pedal with the caliper removed. The brake piston will be pushed out and brake fluid will be spilled.

4. Remove the two axle retainer nuts; then remove the four cap screws securing the lower swing-arm guard.

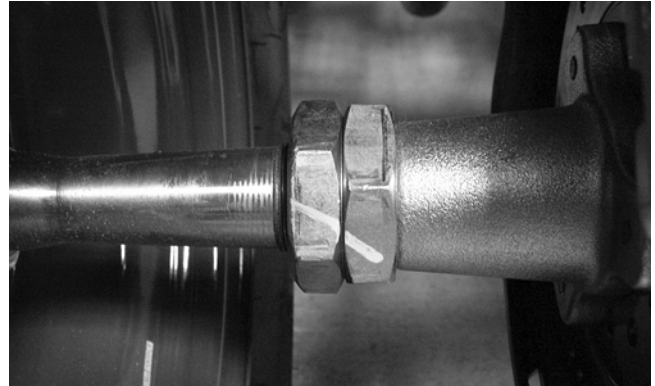

TR015

5. Remove the brake disc assembly from the axle.

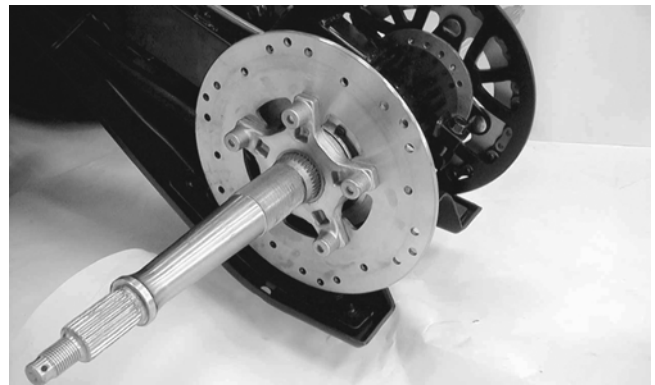

KM472

6. Loosen the drive chain (see Section 2); then slip the chain off the sprocket and remove the axle assembly from the right side.

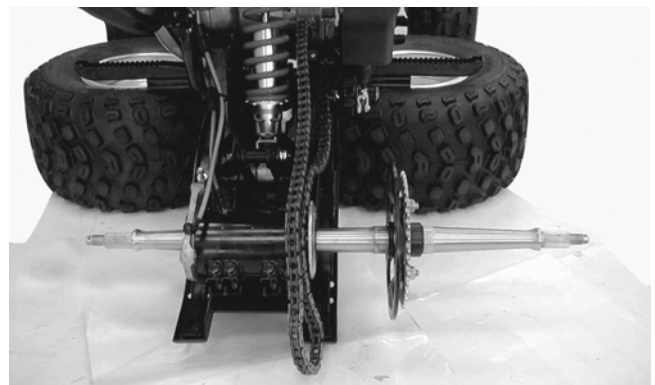

KM476A

7. Remove the nuts securing the driven sprocket to the sprocket hub; then remove the sprocket.



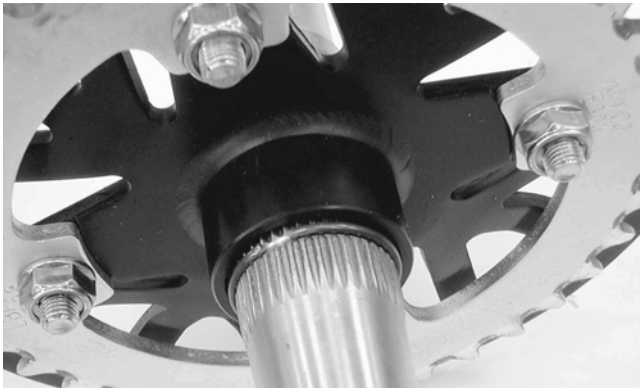

KM477

## CLEANING AND INSPECTING

1. Inspect the sprocket teeth for wear. If they are worn as shown, replace the engine sprocket, rear sprocket, and drive chain as a set.

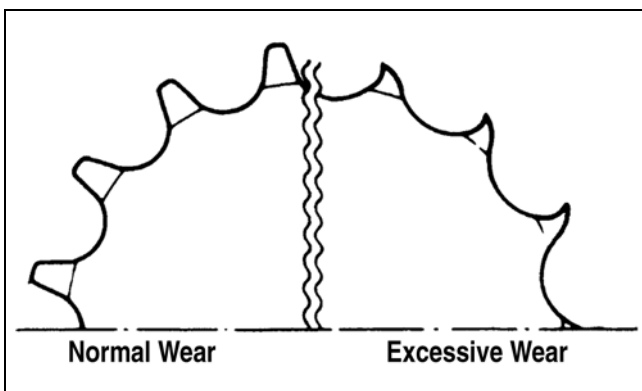

ATV2185

2. Measure the rear axle runout as shown using V blocks and a dial indicator. If the axle runout exceeds 1.5 mm (0.06 in.), the axle must be replaced.

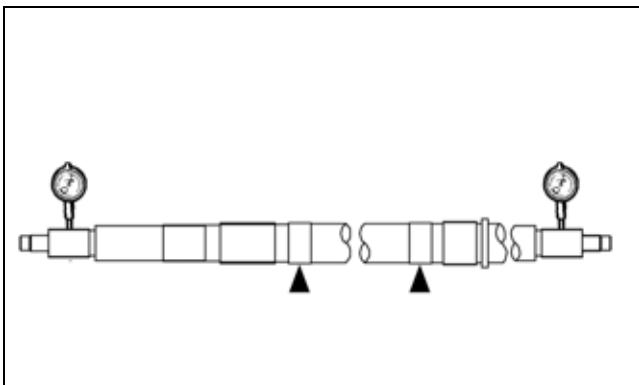

KM480

3. Inspect the dust seals for wear or damage. If any defect is found, replace the dust seal.
4. Inspect the axle bearings by rotating them by hand. If any roughness, binding, or excessive looseness is found, replace the axle bearings.

■NOTE: If the axle bearings are replaced, replace the dust seals with new ones. Always pack the bearings with a good quality wheel bearing grease.

## Removing Bearings

1. Remove the dust seals using an appropriate seal removal tool; then using an appropriate driver, drive the bearings out of the axle housing.

■NOTE: Do not reuse bearings after removal.

2. Clean the axle housing and inspect for cracks, elongated holes, and wear in bearing bores.

## Installing Bearings

1. Pack the new bearings with a good quality wheel bearing grease; then install the right bearing first using an appropriate bearing installer.
2. Install the left bearing; then install new dust seals and lightly coat the lips with grease.

## INSTALLING

1. Slide the axle into the axle housing from the right side; then apply multipurpose grease to all splined areas of the axle.
2. Install the sprocket and sprocket hub on the axle and secure with the nuts; then tighten securely. Install the drive chain.



KM477

3. On the left side, install the brake disc assembly; then install the brake caliper and secure with the two cap screws. Tighten to 24 ft-lb.

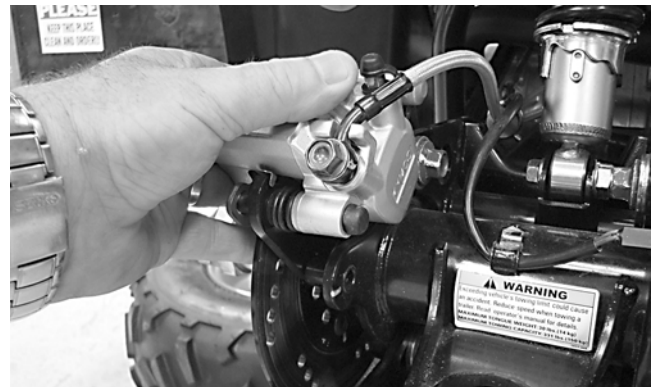

TR236

■NOTE: It is necessary to calculate the torque value using the following formula due to the offset of the special tool used to tighten the axle nuts.

- Coat the axle threads with red Loctite #271 and install one axle nut; then using the Rear Axle Nut Wrench, tighten the inner axle nut to calculated specification.

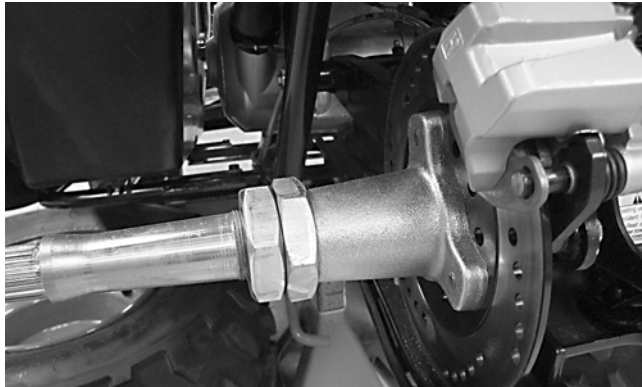

TR235

■NOTE: Compress the left hand brake and engage the brake lever lock to prevent the rear axle from turning.

$$\frac{L \times Ts}{L + Ls} = T$$

T: Torque wrench reading to be calculated

Ts: Specified torque value (86 ft-lb)

Ls: Tool offset length (center to center)

L: Length of torque wrench (handle pivot to headcenter)

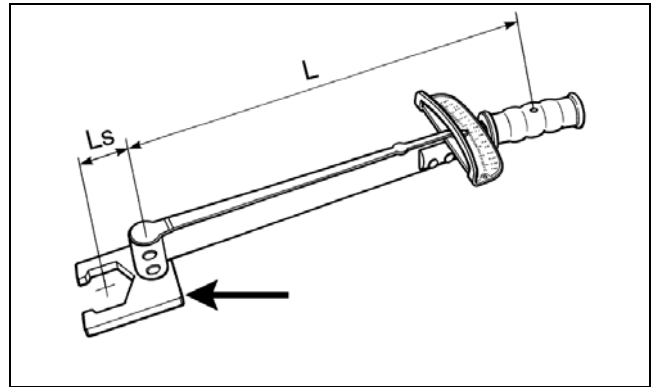

ATV2189

- Install the outer axle nut and tighten to calculated specification.
- Adjust the drive chain (see Section 2); then tighten the two cap screws and adjuster nut.
- Install the wheel hubs and tighten the rear wheel hub nuts to 50 ft-lb; then install the cotter pins and hub caps.
- Install the rear wheels and tighten to 32 ft-lb.

## Troubleshooting Drive System

Problem: Braking Poor	
Condition	Remedy
<ol style="list-style-type: none"> <li>Pad worn</li> <li>Brake fluid leaking</li> <li>Hydraulic system entrapped air</li> <li>Master cylinder/brake cylinder seal worn</li> </ol>	<ol style="list-style-type: none"> <li>Replace pads</li> <li>Repair - replace hydraulic system</li> <li>Bleed hydraulic system</li> <li>Replace appropriate cylinder</li> </ol>
Problem: Brake lever travel excessive	
Condition	Remedy
<ol style="list-style-type: none"> <li>Hydraulic system entrapped air</li> <li>Brake fluid low</li> <li>Brake fluid incorrect</li> <li>Piston seal - cup worn</li> </ol>	<ol style="list-style-type: none"> <li>Bleed hydraulic system</li> <li>Add fluid to proper level/bleed system</li> <li>Replace with correct fluid</li> <li>Replace master cylinder</li> </ol>
Problem: Brake fluid leaking	
Condition	Remedy
<ol style="list-style-type: none"> <li>Connection joints loose</li> <li>Hose cracked</li> <li>Piston seal worn</li> </ol>	<ol style="list-style-type: none"> <li>Tighten joint</li> <li>Replace hose</li> <li>Replace master/brake cylinder</li> </ol>

# SECTION 7 - SUSPENSION

---

---

## TABLE OF CONTENTS

---

Suspension .....	7-2
Front Shock Absorbers.....	7-2
Rear Shock Absorber .....	7-2
Swing Arm.....	7-3
Front A-Arms .....	7-4
Wheels and Tires .....	7-6
Troubleshooting .....	7-8

---

---

## Suspension

---

The following suspension system components should be inspected periodically to ensure proper operation.

- A. Shock absorber rods not bent, pitted, or damaged.
- B. Rubber damper not cracked, broken, or missing.
- C. Shock absorber body not damaged, punctured, or leaking.
- D. Shock absorber eyelets not broken, bent, or cracked.
- E. Shock absorber eyelet bushings not worn, deteriorated, cracked, or missing.
- F. Shock absorber spring not broken or sagging.

---

---

## Front Shock Absorbers

---

■NOTE: Critical torque specifications are located in Section 1.

### REMOVING

1. Secure the ATV on a support stand to elevate the wheels and to release load on the suspension.

**⚠ WARNING**

Make sure the ATV is solidly supported on the support stand to avoid injury.

2. Remove the cap screws and nuts securing each shock absorber to the A-arm and frame.



TR009

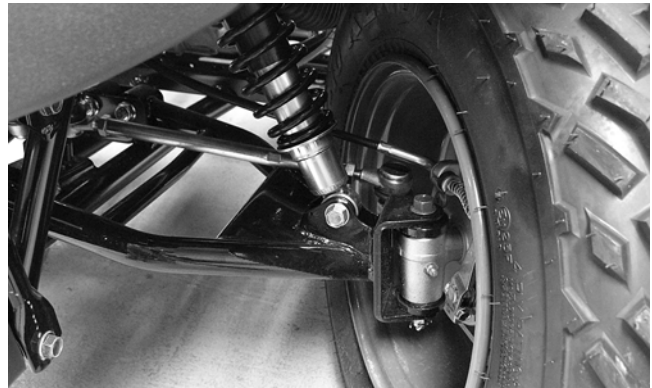

TR010

### CLEANING AND INSPECTING

■NOTE: Whenever a part is worn excessively, cracked, or damaged in any way, replacement is necessary.

1. Clean the shock absorbers in parts-cleaning solvent.
2. Inspect each shock rod for nicks, pits, bends, and oily residue.
3. Inspect the springs, spring retainers, shock rods, shock bodies, and eyelets for cracks, leaks, and bends.

### INSTALLING

1. Install each shock absorber to the frame and A-arm with cap screws and nuts. Tighten all nuts to 29 ft-lb.

**CAUTION**

Do not tighten the nut beyond the recommended specification or the shock eyelet or mount WILL be damaged.

2. Remove the ATV from the support stand.

---

---

## Rear Shock Absorber

---

■NOTE: Critical torque specifications are located in Section 1.

### REMOVING

1. Secure the ATV on a support stand to elevate the wheels and to release load on the suspension.

**⚠ WARNING**

Make sure the ATV is solidly supported on the support stand to avoid injury.

2. Remove the rear shield plate from the swing arm; then remove the lower shock mounting nut and cap screw.

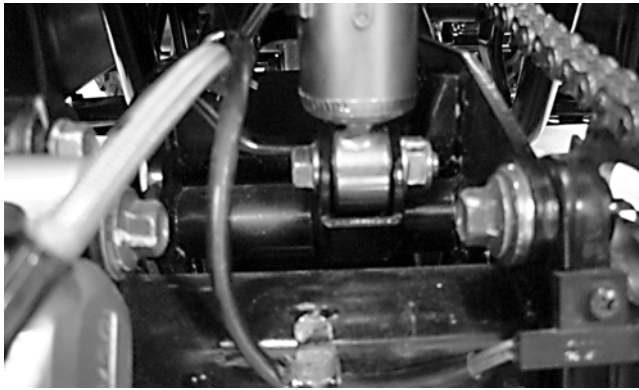

TR231

■NOTE: Support the swing arm with a block of wood or other support to allow removal of the cap screw.

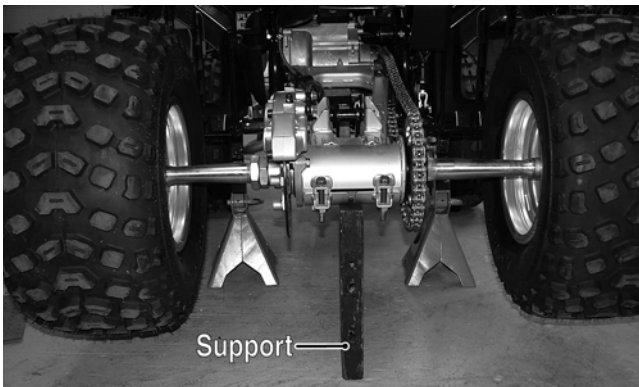

KM555A

3. Remove the upper shock mounting nut and cap screw; then remove the shock absorber from the frame.



KM554

## CLEANING AND INSPECTING

1. Clean the shock absorber in parts-cleaning solvent.
2. Inspect the shock absorber body, bottom stop, and rubber bushing for damage and leaking oil. If any defects are found, replace the shock absorber.
3. Inspect the spring, spring seat, and preload adjuster for damage or corrosion. If corrosion is present, clean with a fine wire brush and oil lightly.

[www.mymowerparts.com](http://www.mymowerparts.com)

## INSTALLING

1. Raise the swing-arm and place the shock absorber in position; then install the upper and lower cap screws and nuts.
2. Tighten the upper nut and the lower nut to 29 ft-lb.
3. Install the rear swing arm skid plate and four cap screws. Tighten securely.

## Swing Arm

■NOTE: Critical torque specifications are located in Section 1.

## REMOVING AND DISASSEMBLING

1. Secure the ATV on a support stand to elevate the wheels and to release load on the suspension.

### ⚠ WARNING

Make sure the ATV is solidly supported on the support stand to avoid injury.

2. Remove the rear wheels; then remove the rear hub caps and hub nuts. Discard the cotter pins.
3. Remove the rear axle assembly (see Section 6); then remove the rear shock absorber.
4. Disconnect the speed sensor wire connectors; then remove the brake hose and speed sensor wires from the holder on the swing arm.

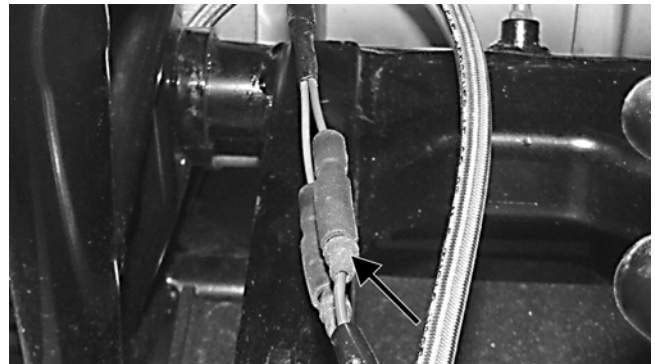

TR229A

5. Remove the nut from the swing arm pivot bolt; then remove the bolt and swing arm.

## CLEANING AND INSPECTING

■NOTE: Whenever a part is worn excessively, cracked, or damaged in any way, replacement is necessary.

1. Inspect the dust seals, bushings, and pivot axle for wear or damage. If any defect is found, they must be replaced.

2. To inspect the swing arm and swing arm axle, place the swing arm axle and bushings in the swing arm; then using the flange bolt, rock the bushings and axle from side to side and up and down. If excessive play is noted, the bushings, axle, or swing arm must be replaced. Check for cracks or broken welds.
3. Remove and clean all pivot bushings, thrust bearings, and pivot axle; then coat all parts with grease and install in the swing arm pivot.

### ASSEMBLING AND INSTALLING

1. Place the swing arm assembly into position in the frame making sure the swing arm thrust covers are properly positioned; then install the pivot bolt and secure with the nut. Tighten to 50 ft-lb.
2. Install the rear shock absorber and secure with the mounting cap screws and nuts. Tighten to 29 ft-lb.
3. Install the rear axle assembly (see Section 6); then install the brake caliper and secure with the cap screws coated with blue Loctite #242. Tighten to 24 ft-lb.
4. Insert the grommet with brake hose and speed sensor wires into the wire holder on the swing arm; then connect the speed sensor wires to the main harness.
5. Install the rear hubs and tighten the nuts to 50 ft-lb; then secure with new cotter pins. Install hub caps.

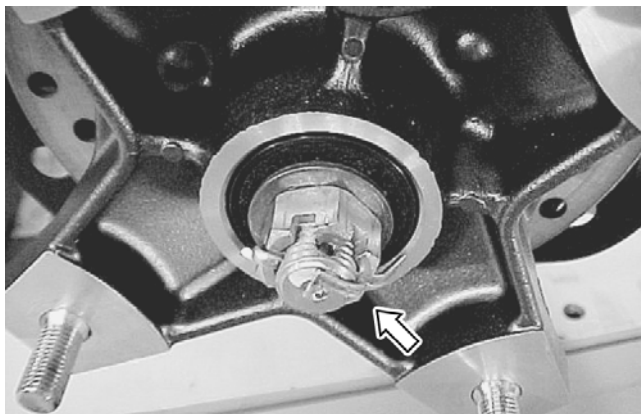

SP366

6. Install the rear wheels and tighten the nuts to 32 ft-lb; then remove the support stand and lower the ATV to the floor.
7. Check chain tension (see Section 2) and make sure the brake functions normally.

---

## Front A-Arms

---

■NOTE: Critical torque specifications are located in Section 1.

### REMOVING

1. Secure the ATV on a support stand to elevate the front wheels; then remove the wheel on the side being serviced.

#### WARNING

Make sure the ATV is solidly supported on the support stand to avoid injury.

2. Remove the cotter pin, castle nut, and washer; then remove the hub assembly.



MD2133

3. Slide brake backing plate assembly off the spindle shaft and secure it out of the way.
4. Remove the cotter pin from the outer tie rod end; then while holding the flat on the tie rod end, remove the castle nut.



MD2428

5. Remove the tie rod end from the steering knuckle.
6. Remove the rubber spindle pin boot; then remove the cotter pin and flanged castle nut from the spindle pin. Lower the steering knuckle assembly from the A-arm.



MD2113

7. Remove the cap screw and self-locking nut securing the shock absorber to the A-arm.



MD2132

8. Remove the cap screws and self-locking nuts securing the A-arm to the frame.

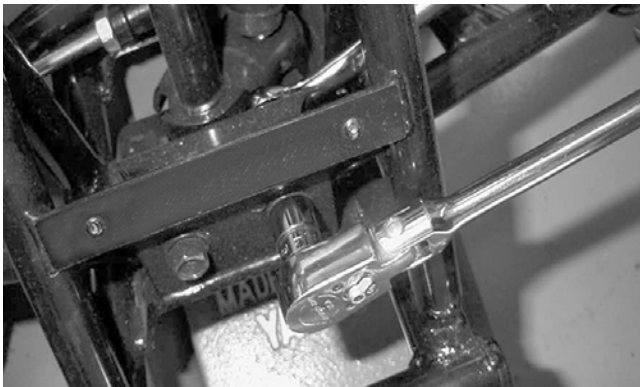

MD2121

9. Remove the A-arm.

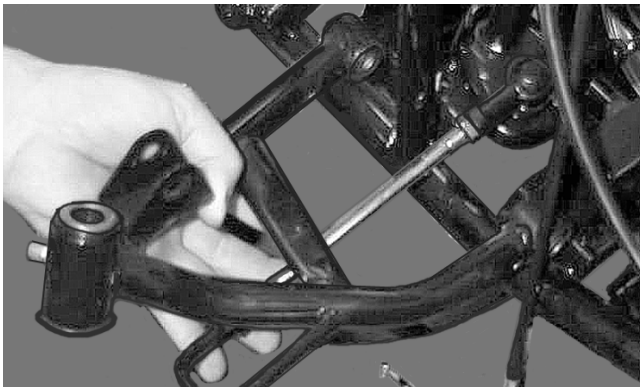

MD2119

## CLEANING AND INSPECTING

■NOTE: Whenever a part is worn excessively, cracked, or damaged in any way, replacement is necessary.

1. Clean all A-arm components in parts-cleaning solvent.
2. Clean the tie rod mounting hole of all residual Loctite, grease, oil, or dirt for installing purposes.
3. Inspect the A-arm for bends, cracks, and worn bushings.
4. Inspect the tie rod mounting holes for cracks or damage.
5. Inspect the frame mounts for signs of damage or wear.

## INSTALLING

■NOTE: During installing, new cotter pins should be installed.

1. Lubricate the A-arm bushings with grease; then install the A-arm into the frame. Install the cap screws and self-locking nuts. Tighten the nuts to 32 ft-lb.

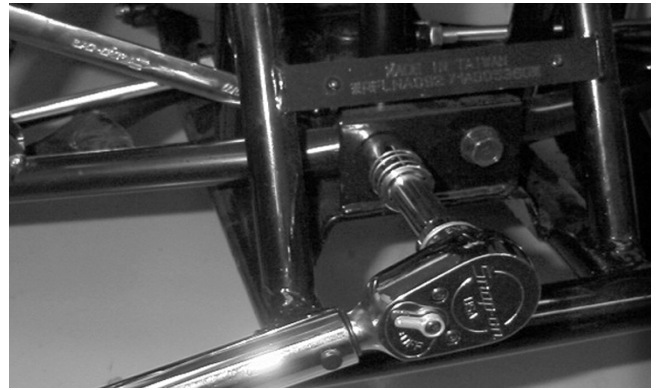

MD2425

2. Secure the shock absorber to the A-arm with the cap screw and self-locking nut. Tighten the nut to 29 ft-lb.

### CAUTION

Do not tighten the nut beyond the 29 ft-lb specification or the shock eyelet or mount WILL be damaged.

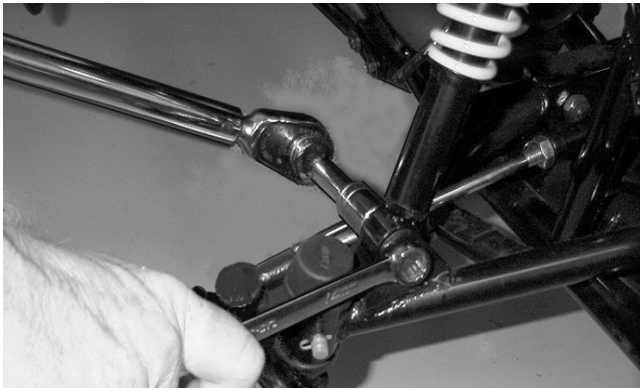

MD2424

3. Lubricate the steering knuckle assembly with grease; then install it into the A-arm and secure with the flanged castle nut. Tighten the nut to 32 ft-lb; then install a new cotter pin and the rubber spindle pin boot.

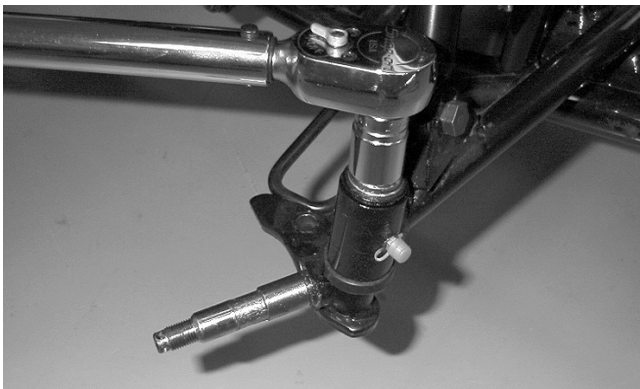

MD2427

4. Install the tie rod end into the steering knuckle and secure it with the self-locking nut. Tighten the nut to 32 ft-lb; then install a new cotter pin.



MD2426

5. Apply a light coat of grease to spindle shaft; then install the brake backing plate assembly onto the shaft.

■NOTE: When installing the brake backing plate assembly, be sure to align the notch in the backing plate with the tab on the steering knuckle.

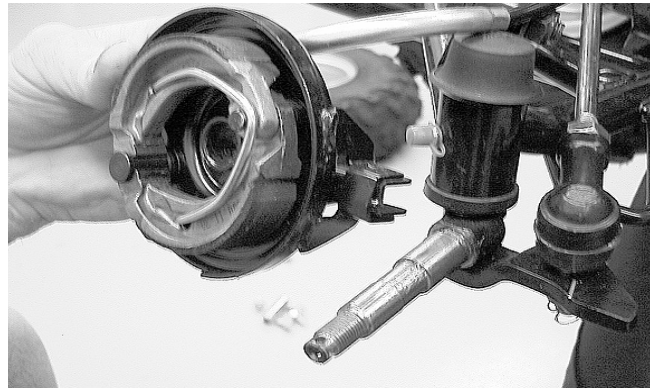

MD2381

6. Place the hub assembly onto the spindle; then install the washer and castle nut. Tighten the castle nut to 50 ft-lb; then install a new cotter pin. Install the wheel and tighten the lug nuts to 32 ft-lb.

---

## Wheels and Tires

---

### TIRE SIZE

#### ⚠ WARNING

Use only Arctic Cat approved tires when replacing tires. Failure to do so could result in unstable ATV operation.

The ATV is equipped with low-pressure tubeless tires of the size and type listed (see Section 1). Do not under any circumstances substitute tires of a different type or size.

#### ⚠ WARNING

Always use the size and type of tires specified. Always maintain proper tire inflation pressure.

#### ⚠ WARNING

Do not mix tire tread patterns. Use the same pattern type on front and rear. Failure to heed warning could cause poor handling qualities of the ATV and could cause excessive drive train damage not covered by warranty.

### TIRE INFLATION PRESSURE

Tire inflation pressure should be as specified in Section 1.

### REMOVING

1. Secure the ATV on a support stand to elevate the wheels.

#### ⚠ WARNING

Make sure the ATV is solidly supported on the support stand to avoid injury.

2. Remove the wheels.

■NOTE: Keep left-side and right-side wheels separated for installing them on their proper sides.



## CLEANING AND INSPECTING

■NOTE: Whenever a part is worn excessively, cracked, or damaged in any way, replacement is necessary.

1. Clean the wheels and hubs with parts-cleaning solvent.
2. Clean the tires with soap and water.
3. Inspect each wheel for cracks, dents, or bends.
4. Inspect each tire for cuts, wear, missing lugs, and leaks.

## INSTALLING

1. Install each wheel on its hub.

■NOTE: Make sure each wheel is installed on its proper hub as noted in removing (the “rotation arrow” must indicate forward direction of rotation).



AF612D

2. Tighten to 32 ft-lb.

## CHECKING/INFLATING

1. Using an air pressure gauge, measure the air pressure in each tire. Adjust the air pressure as necessary to meet the recommended inflation pressure.
2. Inspect the tires for damage, wear, or punctures.

### WARNING

**Do not operate the ATV if tire damage exists.**

■NOTE: If repair is needed, follow the instructions found on the tire repair kit or remove the wheel and have it repaired professionally.

■NOTE: Make sure all tires are the specified size and have identical tread pattern.

3. Check the front wheel toe-in and toe-out and adjust as necessary (see Section 8).
4. Test drive the ATV on a dry, level surface and note any pulling to the left or right during acceleration, deceleration, and braking.

■NOTE: If pulling is noted, measure the circumference of the front and rear tires on the pulling side. Compare the measurements with the tires on the opposite side. If pulling is noted during braking only, check and adjust the brakes as necessary and recheck operation (see Section 2).

5. Increase the air pressure in the tires with the smallest circumference measurement until all tires are equal in circumference.
6. Repeat steps 4-5 as necessary to ensure proper handling.

## Troubleshooting

<b>Problem: Suspension too soft</b>	
<b>Condition</b>	<b>Remedy</b>
<ol style="list-style-type: none"> <li>1. <b>Spring(s)</b> weak</li> <li>2. <b>Shock absorber</b> damaged</li> </ol>	<ol style="list-style-type: none"> <li>1. Replace spring(s)</li> <li>2. Replace shock absorber</li> </ol>
<b>Problem: Suspension too stiff</b>	
<b>Condition</b>	<b>Remedy</b>
<ol style="list-style-type: none"> <li>1. <b>A-arm-related bushings</b> worn or binding</li> </ol>	<ol style="list-style-type: none"> <li>1. Replace bushing</li> </ol>
<b>Problem: Suspension noisy</b>	
<b>Condition</b>	<b>Remedy</b>
<ol style="list-style-type: none"> <li>1. <b>Cap screws (suspension system)</b> loose</li> <li>2. <b>A-arm-related bushings</b> worn</li> </ol>	<ol style="list-style-type: none"> <li>1. Tighten cap screws</li> <li>2. Replace bushings</li> </ol>
<b>Problem: Rear wheel oscillation</b>	
<b>Condition</b>	<b>Remedy</b>
<ol style="list-style-type: none"> <li>1. <b>Rear wheel hub bearings</b> worn - loose</li> <li>2. <b>Tires</b> defective - incorrect</li> <li>3. <b>Wheel rim</b> distorted</li> <li>4. <b>Wheel hub cap screws</b> loose</li> <li>5. <b>Axle shaft nut</b> loose</li> <li>6. <b>Auxiliary brake</b> adjusted incorrectly</li> <li>7. <b>Rear suspension arm-related bushing</b> worn</li> <li>8. <b>Rear shock absorber</b> damaged</li> <li>9. <b>Rear suspension arm nut</b> loose</li> </ol>	<ol style="list-style-type: none"> <li>1. Replace bearings</li> <li>2. Replace tires</li> <li>3. Replace rim</li> <li>4. Tighten cap screws</li> <li>5. Tighten nut</li> <li>6. Adjust brake</li> <li>7. Replace bushing</li> <li>8. Replace shock absorber</li> <li>9. Tighten nut</li> </ol>

# SECTION 8 - STEERING/FRAME

---

---

## TABLE OF CONTENTS

---

Steering/Frame.....	8-2
Steering Post/Tie Rods .....	8-2
Measuring/Adjusting Toe-In/Toe-Out.....	8-4
Body .....	8-4
Steering Post Cover/Instrument Pod .....	8-6
Troubleshooting .....	8-7

## Steering/Frame

The following steering components should be inspected periodically to ensure safe and proper operation.

- A. Handlebar grips not worn, broken, or loose.
- B. Handlebar not bent or cracked and has equal and complete full-left and full-right capability.
- C. Steering post bearing assembly/bearing housing not broken, worn, or binding.
- D. Ball joints not worn, cracked, or damaged.
- E. Tie rods not bent or cracked.
- F. Knuckles not worn, cracked, or damaged.
- G. Cotter pins not damaged or missing.

The frame, welds, and racks should be checked periodically for damage, bends, cracks, deterioration, broken components, and missing components.

## Steering Post/ Tie Rods

■NOTE: Critical torque specifications are located in Section 1.

### REMOVING

1. Remove the front rack and front center panel (see Body in this section).
2. Remove the instrument pod; then remove the cap screws securing the handlebar to the steering post. Account for two handlebar holders.

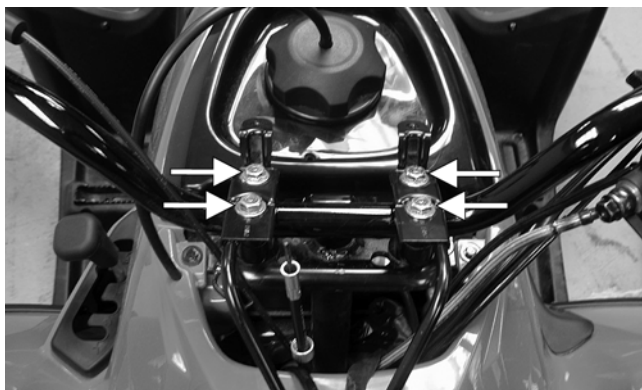

KM189A

3. Lift the handlebar out of the lower handlebar holders and lay the handlebar forward.

4. Remove the cotter pins and slotted nuts securing the tie rod ends to the steering post arm; then disconnect the tie rods from the arm.



KM590

5. Remove the cotter pin and slotted nut from the lower end of the steering post; then remove the upper steering shaft support block. Account for a cable guide, two steering support blocks, and the upper steering post bushing.

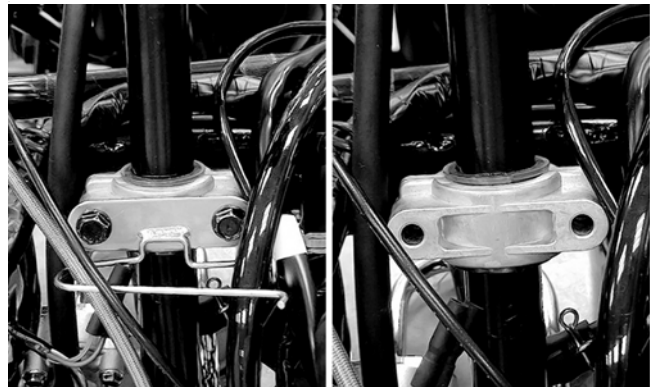

KM588

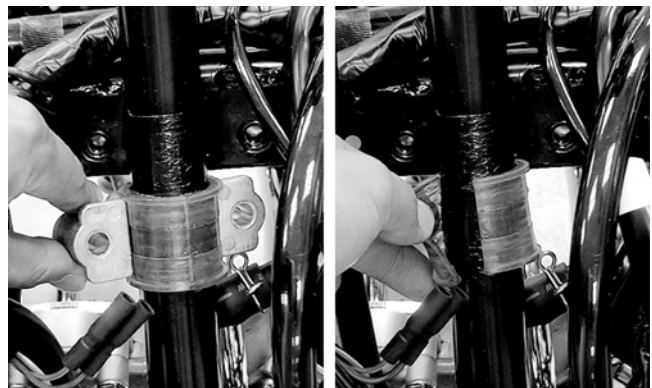

KM589

6. Remove the steering post from the ATV.

### CLEANING AND INSPECTING

■NOTE: Whenever a part is worn excessively, cracked, or damaged in any way, replacement is necessary.

1. Wash the tie rod ends in parts-cleaning solvent. Dry with compressed air. Inspect the pivot area for wear. Apply a low-temperature grease to the ends.

**⚠ WARNING**

Always wear safety glasses when using compressed air.

2. Inspect the tie rods for damaged threads or wear.
3. Inspect the tie rods for cracks or unusual bends.
4. Inspect all welded areas for cracks or deterioration.
5. Inspect the steering post and steering-post holders for cracks, bends, or wear.
6. Inspect the handlebar clamps for cracks or wear.
7. Inspect the handlebar for cracks, wear, or unusual bends.
8. Inspect the handlebar grips for damage or wear.
9. Inspect the lower steering post support bearing and seal for wear or cracks.

**INSTALLING**

1. Apply a thin coat of grease to the lips of the lower steering post seals; then lower the steering post into position in the lower steering post bearings.

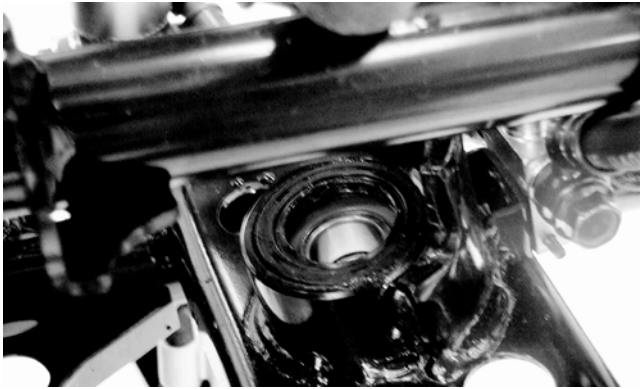

KM593

2. Apply a thin coat of grease to the upper steering post bushing; then secure the steering post with the support blocks and existing hardware. Tighten to 17 ft-lb.

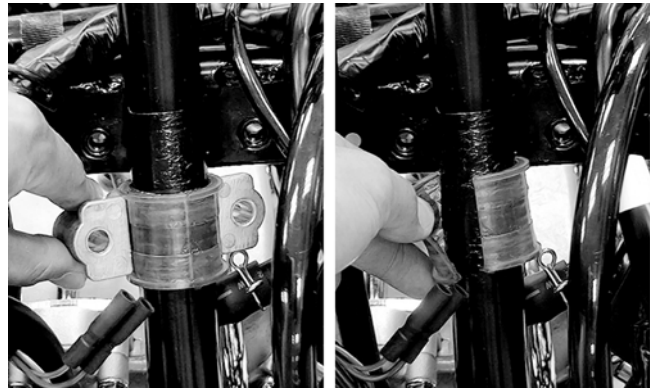

KM589

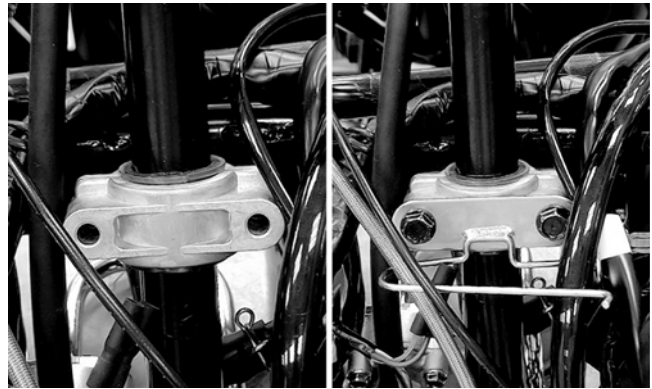

KM595

3. Install the slotted nut on the lower steering post and tighten to 50 ft-lb; then install a new cotter pin.

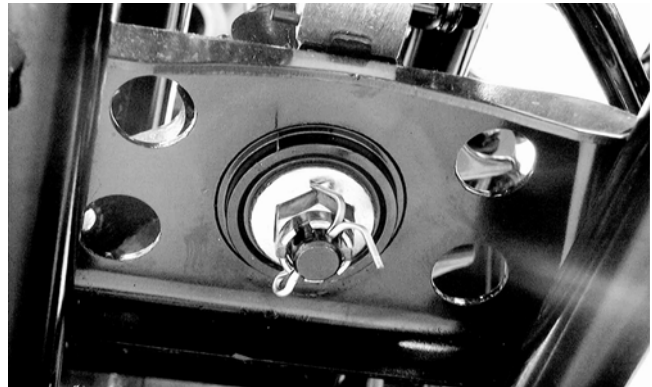

KM591

4. Place the inner tie rod ends into the steering post arm and tighten the slotted nuts to 29 ft-lb; then install new cotter pins.



KM590

5. Install the handlebar to the steering and tighten the clamp cap screws to 15 ft-lb making sure to tighten the front cap screws first.

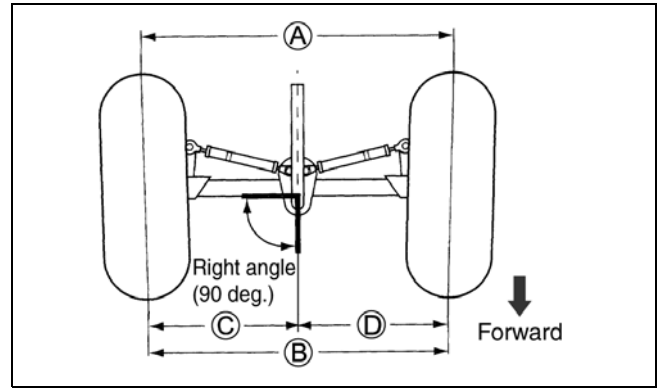
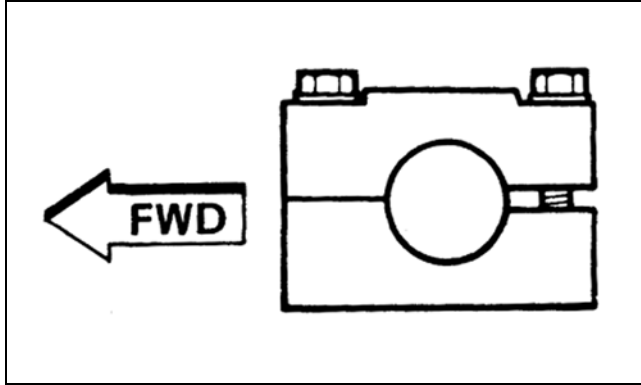

4. Adjust toe-in to 15 mm (0.60 in.); then measure distances (C) and (D). Distances (C) and (D) should be equal.
5. After all the adjustments are to specifications, tighten the tie-rod lock nuts to 22 ft-lb.

■NOTE: Prior to locking the jam nuts, make sure the ball joints are at the center of their normal range of motion and at the correct angle.

■NOTE: The front wheels do not have to be removed to adjust the tie rod. Also, care should be taken not to disturb the handlebar position.



6. Install the instrument pod; then install the center panel and front rack.

## Measuring/Adjusting Toe-In/Toe-Out

1. With the ATV on a level surface, center the handlebar for straight ahead using a suitable means of measuring centering; then adjust tire pressure to specifications (see Section 1).
2. Support the front of the ATV with the wheels free to rotate; then center and secure the handlebar.
3. Measure the distance (A) and (B) between the front wheels; then subtract distance (B) from (A). Distance A - Distance B = Toe-In.

## Body

### REMOVING

1. Remove the seat; then remove the battery cover.

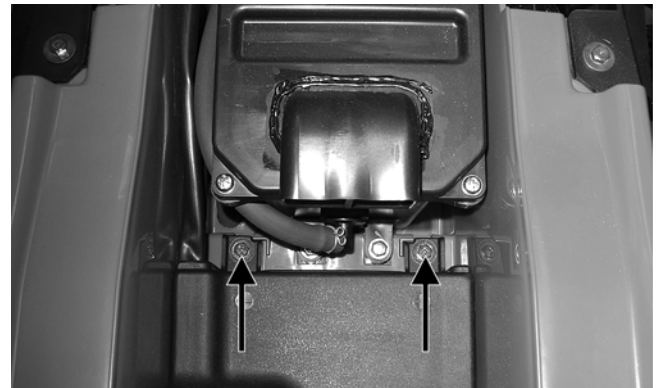

2. Disconnect the negative battery cable first; then the positive cable. Remove the battery.
3. Remove the front and rear racks; then remove the cap screws securing the front center panel and remove the panel.

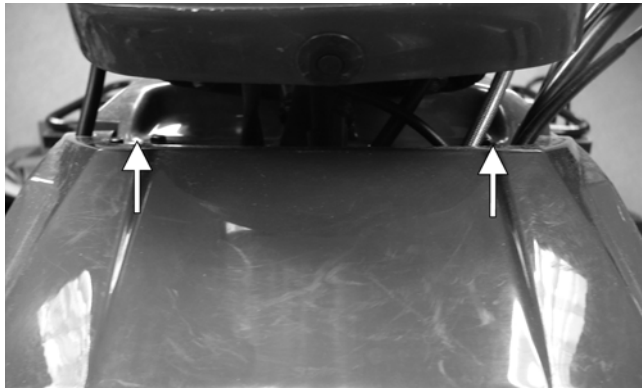

KM308A

4. Remove the cap screws and flange nuts securing the mud guards to the front and rear fenders; then remove the cap screws securing the mud guards to the foot rests and remove the mud guards.

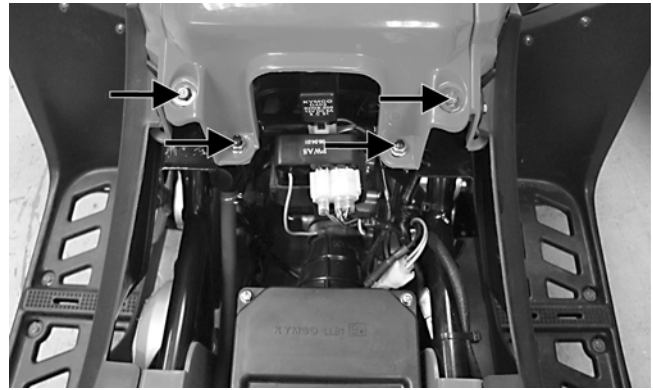

TR241A

## CLEANING AND INSPECTING

■NOTE: Whenever a part is worn excessively, cracked, or damaged in any way, replacement is necessary.

1. Clean all body components with soap and water.
2. Inspect the body and fenders for cracks.
3. Inspect threaded areas of all mounting studs for stripping.
4. Inspect for missing decals.

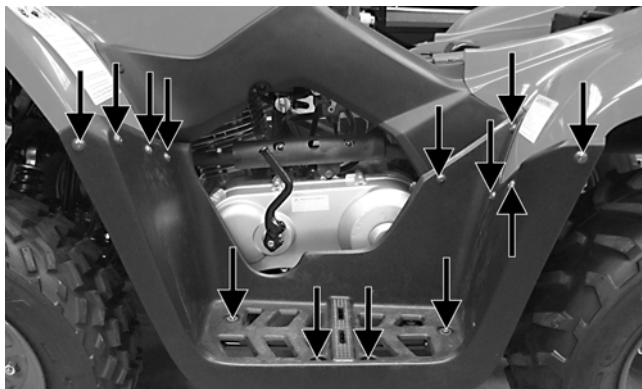

TR240A

5. Remove the side panels; then remove the cap screws and flange nuts securing the front and rear fenders to the frame and fender supports.

## INSTALLING

1. Place the front and rear fenders into position on the frame and secure with the existing hardware; then install the gas tank cover. Tighten all fasteners securely.
2. Connect the headlight and taillight connectors; then install the shift knob.
3. Making sure the locating tabs engage the appropriate slots in the fenders, install the side panels.

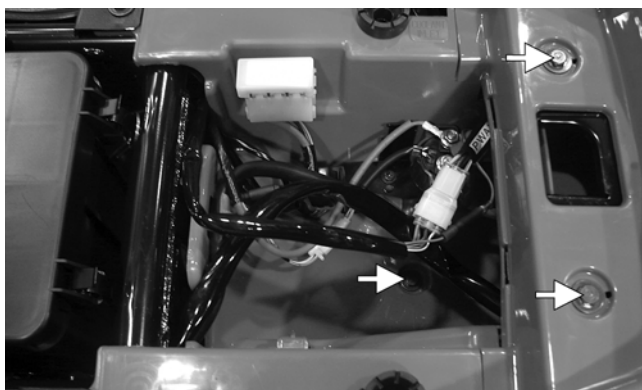

KM799B

6. Disconnect the left and right headlight connectors; then disconnect the taillight.
7. Remove the gas tank cover; then remove the shift knob and front and rear fenders.

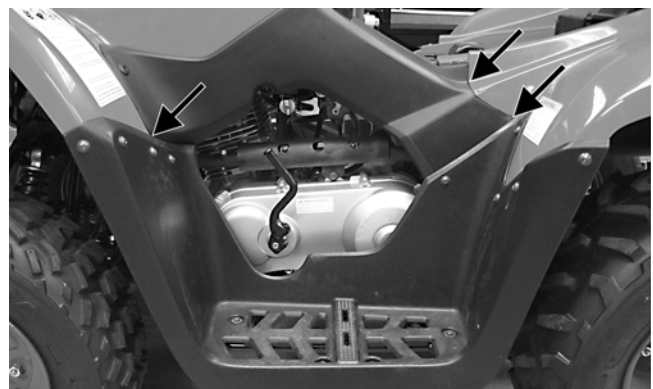

TR240B

4. Install the mud guards and secure to the fenders and foot rest supports with the existing hardware. Make sure all locating tabs are appropriately engaged with the fenders and side panels.

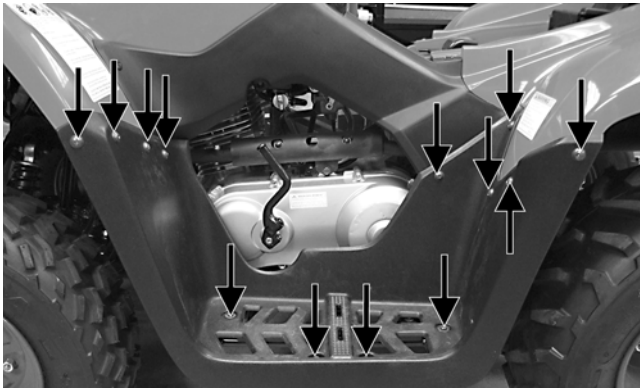

TR240A

5. Install the front center cover; then install the front and rear racks. Tighten all fasteners securely.
6. Install the battery; then connect the positive battery cable, negative battery cable, and install the battery cover.

■NOTE: Always install the positive cable first; then install the negative cable.

7. Install the seat making sure it locks securely in place.

---

---

## Steering Post Cover/Instrument Pod

---

---

### REMOVING

1. Remove the reinstallable rivet on the front of the instrument pod and the two cap screws on the rear; then lift the assembly off and disconnect the speedometer cable.
2. Remove the self-tapping screw securing the LCD gauge assembly to the instrument pod; then remove the LCD gauge.

■NOTE: The LCD gauge is not a serviceable component. If any functions are incorrect or indicator lights do not illuminate, the LCD gauge must be replaced.

### INSTALLING

1. Connect the main harness connector to the LCD gauge; then connect the ignition harness to the ignition connectors.
2. Place the instrument pod onto the mounting bracket; then secure with the reinstallable rivet and two cap screws.



## Troubleshooting

<b>Problem: Handling too heavy or stiff</b>	
<b>Condition</b>	<b>Remedy</b>
<ol style="list-style-type: none"> <li>1. <b>Front wheel alignment</b> incorrect</li> <li>2. <b>Lubrication</b> inadequate</li> <li>3. <b>Tire inflation pressure</b> incorrect</li> <li>4. <b>Tie rod ends</b> seizing</li> <li>5. <b>Linkage connections</b> seizing</li> </ol>	<ol style="list-style-type: none"> <li>1. Adjust alignment</li> <li>2. Lubricate appropriate components</li> <li>3. Adjust pressure</li> <li>4. Replace tie rod ends</li> <li>5. Repair - replace connections</li> </ol>
<b>Problem: Steering oscillation</b>	
<b>Condition</b>	<b>Remedy</b>
<ol style="list-style-type: none"> <li>1. <b>Tires</b> inflated unequally</li> <li>2. <b>Wheel(s)</b> wobbly</li> <li>3. <b>Wheel hub cap screw(s)</b> loose - missing</li> <li>4. <b>Wheel hub bearing</b> worn - damaged</li> <li>5. <b>Tie rod ends</b> worn - loose</li> <li>6. <b>Tires</b> defective - incorrect</li> <li>7. <b>A-arm bushings</b> damaged</li> <li>8. <b>Bolts - nuts (frame)</b> loose</li> </ol>	<ol style="list-style-type: none"> <li>1. Adjust pressure</li> <li>2. Replace wheel(s)</li> <li>3. Tighten - replace cap screws</li> <li>4. Replace bearing</li> <li>5. Replace - tighten tie rod ends</li> <li>6. Replace tires</li> <li>7. Replace bushings</li> <li>8. Tighten bolts - nuts</li> </ol>
<b>Problem: Steering pulling to one side</b>	
<b>Condition</b>	<b>Remedy</b>
<ol style="list-style-type: none"> <li>1. <b>Tires inflated</b> unequally</li> <li>2. <b>Front wheel alignment</b> incorrect</li> <li>3. <b>Wheel hub bearings</b> worn - broken</li> <li>4. <b>Frame</b> distorted</li> <li>5. <b>Shock absorber</b> defective</li> </ol>	<ol style="list-style-type: none"> <li>1. Adjust pressure</li> <li>2. Adjust alignment</li> <li>3. Replace bearings</li> <li>4. Repair - replace frame</li> <li>5. Replace shock absorber</li> </ol>
<b>Problem: Steering impaired</b>	
<b>Condition</b>	<b>Remedy</b>
<ol style="list-style-type: none"> <li>1. <b>Tire pressure</b> too high</li> <li>2. <b>Steering linkage connections</b> worn</li> <li>3. <b>Cap screws (suspension system)</b> loose</li> </ol>	<ol style="list-style-type: none"> <li>1. Adjust pressure</li> <li>2. Replace connections</li> <li>3. Tighten cap screws</li> </ol>
<b>Problem: Tire wear rapid or uneven</b>	
<b>Condition</b>	<b>Remedy</b>
<ol style="list-style-type: none"> <li>1. <b>Wheel hub bearings</b> worn - loose</li> <li>2. <b>Front wheel alignment</b> incorrect</li> </ol>	<ol style="list-style-type: none"> <li>1. Replace bearings</li> <li>2. Adjust alignment</li> </ol>
<b>Problem: Steering noise</b>	
<b>Condition</b>	<b>Remedy</b>
<ol style="list-style-type: none"> <li>1. <b>Cap screws - nuts</b> loose</li> <li>2. <b>Wheel hub bearings</b> broken - damaged</li> <li>3. <b>Lubrication</b> inadequate</li> </ol>	<ol style="list-style-type: none"> <li>1. Tighten cap screws - nuts</li> <li>2. Replace bearings</li> <li>3. Lubricate appropriate components</li> </ol>

# SECTION 9 - CONTROLS/INDICATORS

---

---

## TABLE OF CONTENTS

---

Rear Brake Lever/Master Cylinder Assembly.....	9-2
Front Brake Lever .....	9-3
Throttle Control .....	9-4

## Rear Brake Lever/ Master Cylinder Assembly

■NOTE: The master cylinder is a non-serviceable component; it must be replaced as an assembly.

### REMOVING

1. Connect a clear hose to the bleed screw on the rear brake caliper; then open the bleed screw and pump the brake fluid into a suitable container. Close the bleed screw.

### CAUTION

Brake fluid is highly corrosive. Do not spill brake fluid on any surface of the ATV.

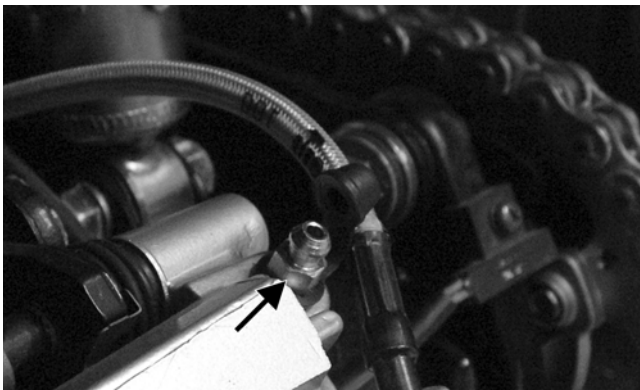

TR031A

■NOTE: Do not reuse brake fluid. When exposed to air, brake fluid rapidly absorbs moisture.

2. Remove the brakeline hose union bolt; then remove the cap screws securing the master cylinder assembly to the handlebar. Discard the crush washers from the union bolt.



KM800A

3. Remove the brake lever, brakelight switch, and brake lever lock.

### INSPECTING

■NOTE: Whenever a part is worn excessively, cracked, or damaged in any way, replacement is necessary.

1. Inspect the pivot bolt securing the brake lever for wear.
2. Inspect the brake lever for elongation of the pivot hole.
3. Inspect the reservoir for cracks and leakage.
4. Inspect the brake hose for cracks and deterioration and the condition of the fittings (threaded and compression).
5. Inspect the brakelight switch for corrosion, cracks, missing or broken mounting tabs, or broken and frayed wiring.

■NOTE: If the brakelight switch is determined to be not serviceable, see Section 5.

### INSTALLING

1. Install the brakelight switch on the master cylinder; then install the brake lever and brake lever lock.
2. Install the master cylinder assembly on the handlebar engaging the alignment stud in the hole in the handlebar; then secure with the master cylinder clamp and two cap screws. Make sure the UP arrow on the clamp is directed upward.

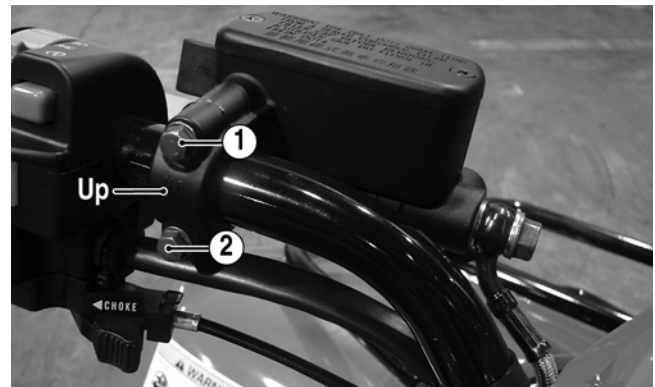

KM800B

3. Tighten the cap screw (1) to 9 ft-lb; then tighten the cap screw (2) to 9 ft-lb.

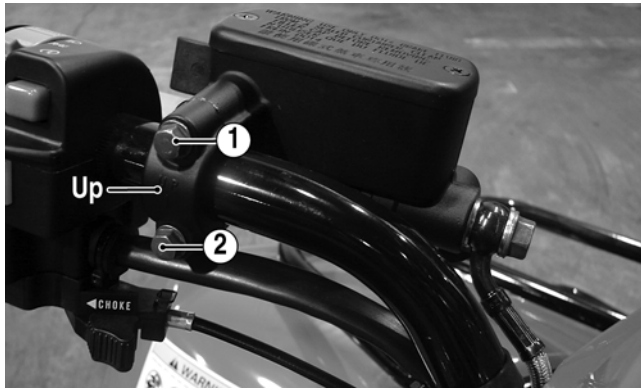

KM800B

- Using new crush washers, secure the brake hose to the master cylinder with the brake hose union bolt. Tighten to 24 ft-lb.



KM800A

- Fill the master cylinder with DOT 4 brake fluid; then bleed the system (see Section 2).

## Front Brake Lever

### **WARNING**

After removing and installing of components that are brake-related, **ALWAYS** check and adjust brakes as necessary before operating the ATV.

### REMOVING

- Remove the right handlebar grip (see Section 8).
- Remove the cover from the throttle control housing exposing the throttle cable; then remove the cable.

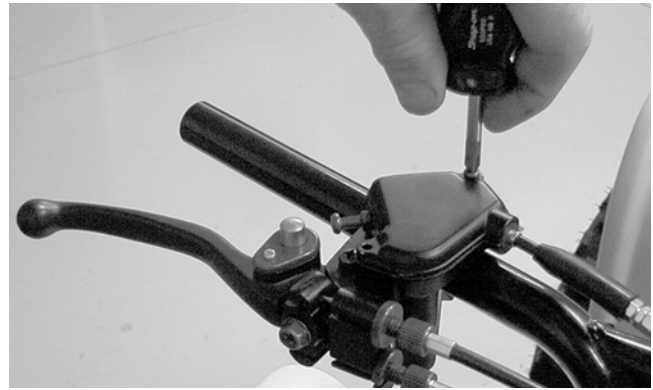

MD2440

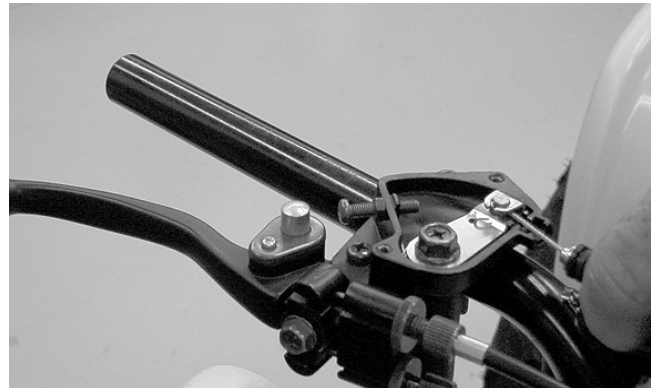

MD2439

- Remove the front brake cables from their adjusters by screwing the adjusters inward to loosen the cables; then pulling them free.

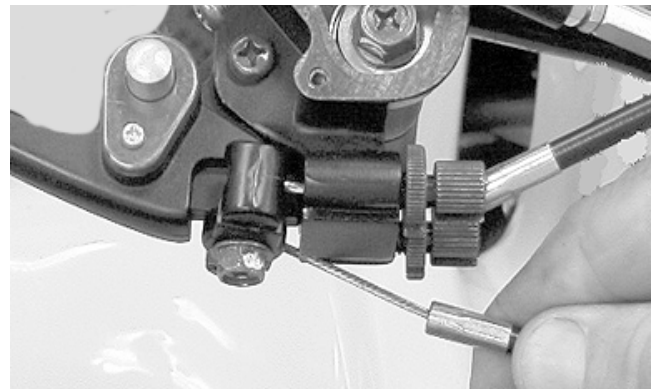

MD2449

- Loosen the screw securing the front brake lever assembly and slide the assembly off the handlebar.

**9**



MD2450

## INSTALLING

1. Slide the right brake lever assembly onto the handlebar; do not tighten the screw completely at this time.



MD2452

2. Install the throttle cable into the throttle control housing; then install the cover and secure with the screws.



MD2454



KM548A

3. Install the brake cable to the lever assembly.

**NOTE:** Before installing a handlebar grip, use contact spray or alcohol to clean the inside of the grip and the handlebar of adhesive residue, oil, or any other contaminant.

4. Apply a liberal amount of Handlebar Grip Adhesive to the inside of the grip; then slide the right grip onto the handlebar. Wipe off any excess adhesive.
5. Tighten the right brake lever assembly screw (from step 1) securely.



MD2461

## Throttle Control

### REMOVING

1. Remove the boot from the throttle cable adjuster; then loosen the jam nut and turn the adjuster completely in to loosen the cable.
2. Remove the three machine screws securing the cover to the throttle control; then remove the cover and disengage the throttle cable from the throttle arm.
3. Turn the cable adjuster out of the throttle control housing; then remove the two machine screws securing the throttle control to the handlebar and remove the throttle control.

### INSTALLING

1. Making sure the throttle housing upper flat aligns with the alignment mark on the handlebar, place the throttle control into position on the handlebar and secure with the two machine screws; then tighten the machine screws securely.

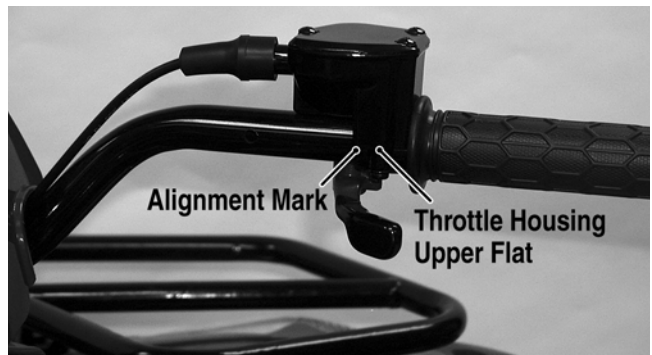

KM122B

2. Thread the throttle cable into the throttle housing and turn the adjuster completely in; then connect the throttle cable to the throttle arm.
3. Install the throttle housing cover; then adjust the throttle cable (see Section 4).