

---

---





## FOREWORD

---

This Arctic Cat Service Manual contains service, maintenance, and troubleshooting information for the 2007 Arctic Cat Prowler/XT. The complete manual is designed to aid service personnel in service-oriented applications.

This manual is divided into sections. Each section covers a specific vehicle component or system and, in addition to the standard service procedures, includes disassembling, inspecting, and assembling instructions. When using this manual as a guide, the technician should use discretion as to how much disassembly is needed to correct any given condition.

The service technician should become familiar with the operation and construction of each component or system by carefully studying this manual. This manual will assist the service technician in becoming more aware of and efficient with servicing procedures. Such efficiency not only helps build consumer confidence but also saves time and labor.

All Arctic Cat publications and decals display the words Warning, Caution, Note, and At This Point to emphasize important information. The symbol  **WARNING** identifies personal safety-related information. Be sure to follow the directive because it deals with the possibility of severe personal injury or even death. The symbol  **CAUTION** identifies unsafe practices which may result in vehicle-related damage. Follow the directive because it deals with the possibility of damaging part or parts of the vehicle. The symbol  **NOTE:** identifies supplementary information worthy of particular attention. The symbol  **AT THIS POINT** directs the technician to certain and specific procedures to promote efficiency and to improve clarity.

At the time of publication, all information, photographs, and illustrations were technically correct. Some photographs used in this manual are used for clarity purposes only and are not designed to depict actual conditions. Because Arctic Cat Inc. constantly refines and improves its products, no retroactive obligation is incurred.

All materials and specifications are subject to change without notice.

Keep this manual accessible in the shop area for reference.

Product Service and  
Warranty Department  
Arctic Cat Inc.

## TABLE OF CONTENTS

### Foreword

Click on the red text to go.

### Section



#### 1. General Information

1

#### 2. Periodic Maintenance/Tune-Up

2

#### 3. Engine/Transmission

3



#### 4. Fuel/Lubrication/Cooling

4

#### 5. Electrical System

5



#### 6. Drive System

6

#### 7. Suspension

7

#### 8. Steering/Frame

8

#### 9. Controls/Indicators

9

#### 10. Aids for Maintenance

10

#### 11. Troubleshooting

11

Prowler  
Prowler XT



# SECTION 1 - GENERAL INFORMATION

---

---

## TABLE OF CONTENTS

---

General Specifications .....	1-2
Break-In Procedure .....	1-3
Gasoline - Oil - Lubricant .....	1-3
Genuine Parts .....	1-4
Preparation For Storage .....	1-4
Preparation After Storage.....	1-5

## General Specifications\*

CARBURETOR	
Type	Keihin CVK36
Main Jet	132
Slow Jet	40
Low Speed Fuel Screw Setting (turns)	1 1/4
Jet Needle	Fixed
Needle Jet	6.0/4.0
Idle RPM	1250-1350
Starter Jet	85
Float Arm Height	17 mm (0.7 in.)
ELECTRICAL	
Ignition Timing	10° BTDC @ 1500 RPM
Spark Plug Type	Champion RG6YC
Spark Plug Gap	0.7-0.8 mm (0.028-0.032 in.)
Spark Plug Cap	3750-6250 ohms
Ignition Coil Resistance (primary)	Less than 1 ohm (terminal to ground) 5200-7800 ohms (high tension - plug cap removed - to ground)
(secondary)	
Ignition Coil Peak Voltage (primary/CDI)	142.4-213.6 DC volts (blue/white to ground)
Magneto Coil Resistance (trigger)	160-240 ohms (green to blue)
(source)	Less than 1 ohm (yellow to white)
(charging)	Less than 1 ohm (black to black)
Magneto Coil Peak Voltage (trigger)	4.2-6.3 volts (green to blue)
(source)	0.40-0.62 volt (yellow to white)
Stator Coil Output (no load)	60 AC volts @ 5000 RPM (black to black)
Magneto Output (approx)	325W @ 5000 RPM

CHASSIS	
Dry Weight (approx)	526 kg (1160 lb)
Length (overall)	292 cm (115 in.)
Height (overall)	197 cm (77.5 in.)
Width (overall)	156 cm (61.3 in.)
Suspension Travel (front)	25.4 cm (10 in.)
(rear)	25.4 cm (10 in.)
Brake Type	Hydraulic
Wheelbase	190 cm (75 in.)
Tracking (front)	128.3 cm (50.5 in.)
(rear)	123.2 cm (48.5 in.)
Tire Size (front)	26 x 9-14
(rear)	26 x 11-14
Tire Inflation Pressure	0.70 kg/cm <sup>2</sup> (10 psi)
Turning Radius	3.3 m (10.8 ft)
MISCELLANY	
Gas Tank Capacity (rated)	31 L (8.2 U.S. gal.)
Coolant Capacity	2.9 L (3.0 U.S. qt)
Differential Capacity	275 ml (9.3 fl oz)**
Rear Drive Capacity	250 ml (8.5 fl oz)**
Engine Oil Capacity	2.5 L (2.6 U.S. qt)
Gasoline (recommended)	87 Octane Regular Unleaded
Engine Oil (recommended)	SAE 5W-30
Differential/Rear Drive Lubricant	SAE Approved 80W-90 Hypoid
Belt Width	35.0 mm (1.38 in.)
Brake Fluid	DOT 4
Taillight/Brakelight	12V/8W/27W
Headlight	12V/27W (2)
Starting System	Electric

\* Specifications subject to change without notice.

\*\* 1 inch below plug threads.

## Break-In Procedure

A new vehicle and an overhauled engine require a “break-in” period. The first 10 hours (or 200 miles) are most critical to the life of this vehicle. Proper operation during this break-in period will help assure maximum life and performance from the vehicle.

During the first 10 hours (or 200 miles) of operation, always use less than 1/2 throttle. Varying the engine RPM during the break-in period allows the components to “load” (aiding the mating process) and then “unload” (allowing components to cool). Although it is essential to place some stress on the engine components during break-in, care should be taken not to overload the engine too often. Do not pull a trailer or carry heavy loads during the 10-hour break-in period.

When the engine starts, allow it to warm up properly. Idle the engine several minutes until the engine has reached normal operating temperature. Do not idle the engine for excessively long periods of time.

During the break-in period, a maximum of 1/2 throttle is recommended; however, brief full-throttle accelerations and variations in driving speeds contribute to good engine break-in.

During the break-in period (or whenever the brake pads are replaced), the hydraulic brake pads must be burnished. Slow disc-speed hydraulic brakes must be properly burnished in order to achieve maximum stopping power.

### ⚠ CAUTION

**BRAKE PADS MUST BE BURNISHED TO ACHIEVE FULL BRAKING EFFECTIVENESS.** Braking distance will be extended until brake pads are properly burnished.

**TO PROPERLY BURNISH THE BRAKES, USE FOLLOWING PROCEDURE:**

- Choose an area sufficiently large to safely accelerate vehicle to 30 mph and to brake to a stop.
- Accelerate to 30 mph; then apply the brake to decelerate to 0-5 mph.
- Repeat procedure five times until brakes are burnished.
- This procedure burnishes the brake pads, stabilizes the pad material, and extends the life of the brake pads.

### ⚠ WARNING

Do not attempt sudden stops or put the vehicle into a situation where a sudden stop will be required until the brake pads are properly burnished.

■ **NOTE:** Do not be reluctant to heat up the brake pads during the burnishing procedure.

After the completion of the break-in period, the engine oil and oil filter should be changed. Other maintenance after break-in should include checking of all prescribed adjustments and tightening of all fasteners.

## Gasoline - Oil - Lubricant

1

### RECOMMENDED GASOLINE

The recommended gasoline to use is 87 minimum octane regular unleaded. In many areas, oxygenates (either ethanol or MTBE) are added to the gasoline. Oxygenated gasolines containing up to 10% ethanol, 5% methane, or 5% MTBE are acceptable gasolines.

When using ethanol blended gasoline, it is not necessary to add a gasoline antifreeze since ethanol will prevent the accumulation of moisture in the fuel system.

### ⚠ CAUTION

Do not use white gas. Only Arctic Cat approved gasoline additives should be used.

### RECOMMENDED ENGINE/ TRANSMISSION OIL

### ⚠ CAUTION

Any oil used in place of the recommended oil could cause serious engine damage. Do not use oils which contain graphite or molybdenum additives. These oils can adversely affect clutch operation. Also, not recommended are racing, vegetable, non-detergent, and castor-based oils.

The recommended oil to use is Arctic Cat 4-Cycle Engine Oil or an equivalent oil which is rated SE, SF, or SG under API service classification. These oils meet all of the lubrication requirements of the Arctic Cat engine. The recommended engine oil viscosity is SAE 5W-30. Ambient temperature should determine the correct weight of oil. See the following viscosity chart for details.

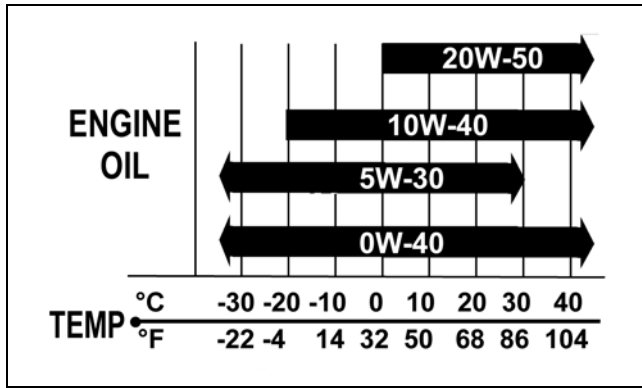

OILCHARTC

### RECOMMENDED FRONT DIFFERENTIAL/REAR DRIVE LUBRICANT

The recommended lubricant is Arctic Cat Gear Lube or an equivalent gear lube which is SAE approved 80W-90 hypoid. This lubricant meets all of the lubrication requirements of the Arctic Cat vehicle front differential and rear drive.

**CAUTION**

Any lubricant used in place of the recommended lubricant could cause serious front differential/rear drive damage.

### FILLING GAS TANK

**WARNING**

Always fill the gas tank in a well-ventilated area. Never add fuel to the gas tank near any open flames or with the engine running. DO NOT SMOKE while filling the gas tank.

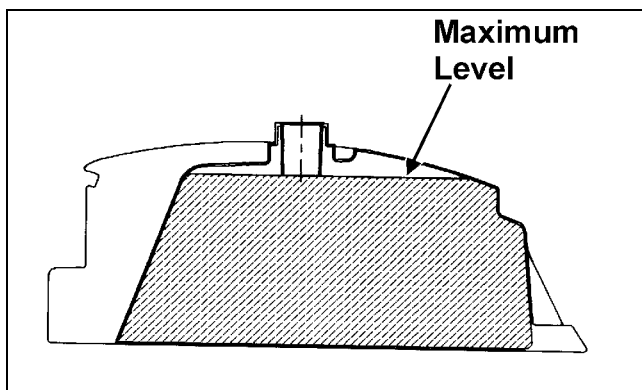

ATV0049B

Since gasoline expands as its temperature rises, the gas tank must be filled to its rated capacity only. Expansion room must be maintained in the tank particularly if the tank is filled with cold gasoline and then moved to a warm area.

**WARNING**

Do not overflow gasoline when filling the gas tank. A fire hazard could materialize. Always allow the engine to cool before filling the gas tank.

Tighten the gas tank cap securely after filling the tank.

**WARNING**

Do not over-fill the gas tank.

## Genuine Parts

When replacement of parts is necessary, use only genuine Arctic Cat parts. They are precision-made to ensure high quality and correct fit. Refer to the Illustrated Parts Manual for the correct part number, quantity, and description.

## Preparation For Storage

**CAUTION**

Prior to storing the vehicle, it must be properly serviced to prevent rusting and component deterioration.

Arctic Cat recommends the following procedure to prepare the vehicle for storage.

1. Clean the seat cushion (cover and base) with a damp cloth and allow it to dry.
2. Clean the vehicle thoroughly by washing dirt, oil, grass, and other foreign matter from the entire vehicle. Allow it to dry thoroughly. DO NOT get water into any part of the engine or air intake.

3. Either drain the gas tank or add Fuel Stabilizer to the gas in the gas tank. Remove the air filter housing cover and air filter. Start the engine and allow it to idle; then using Arctic Cat Engine Storage Preserver, rapidly inject the preserver into the air filter opening for a period of 10 to 20 seconds; then stop the engine. Install the air filter and housing cover.

**⚠ CAUTION**

If the interior of the air filter housing is dirty, clean the area before starting the engine.

4. Drain the carburetor float chamber.
5. Plug the exhaust hole in the exhaust system with a clean cloth.
6. Apply light oil to the plungers of the shock absorbers.
7. Tighten all nuts, bolts, cap screws, and screws. Make sure rivets holding components together are tight. Replace all loose rivets. Care must be taken that all calibrated nuts, cap screws, and bolts are tightened to specifications (see Section 10).
8. Fill the cooling system to the bottom of the stand pipe in the radiator neck with properly mixed coolant.
9. Disconnect the battery cables; then remove the battery, clean the battery posts and cables, and store in a clean, dry area.
10. Store the vehicle indoors in a level position.

**⚠ CAUTION**

Avoid storing outside in direct sunlight and avoid using a plastic cover as moisture will collect on the vehicle causing rusting.

---

---

## Preparation After Storage

---

Taking the vehicle out of storage and correctly preparing it will assure many miles and hours of trouble-free riding. Arctic Cat recommends the following procedure to prepare the vehicle.

1. Clean the vehicle thoroughly.
2. Clean the engine. Remove the cloth from the exhaust system.

3. Check all control wires and cables for signs of wear or fraying. Replace if necessary.
4. Change the engine/transmission oil and filter.
5. Check the coolant level and add properly mixed coolant as necessary.
6. Charge the battery; then install. Connect the battery cables.

**⚠ CAUTION**

The ignition switch must be in the OFF position prior to installing the battery or damage may occur to the ignition system.

**⚠ CAUTION**

Connect the positive battery cable first; then the negative.

7. Check the entire brake systems (fluid level, pads, etc.), all controls, headlights, taillight, brakelight, and headlight aim; adjust or replace as necessary.
8. Tighten all nuts, bolts, cap screws, and screws making sure all calibrated nuts, cap screws, and bolts are tightened to specifications (see Section 10).
9. Check tire pressure. Inflate to recommended pressure as necessary.
10. Make sure the steering moves freely and does not bind.
11. Check the spark plug. Clean or replace as necessary.

1



# SECTION 2 - PERIODIC MAINTENANCE/TUNE-UP

---



---

## TABLE OF CONTENTS

---

Periodic Maintenance Chart.....	2-2
Lubrication Points.....	2-3
Battery.....	2-3
Fuses.....	2-4
Air Cleaner/Filter.....	2-4
Valve/Tappet Clearance (Feeler Gauge Procedure).....	2-6
Valve/Tappet Clearance (Valve Adjuster Procedure).....	2-6
Testing Engine Compression.....	2-7
Spark Plug.....	2-7
Muffler/Spark Arrester.....	2-8
Gas/Vent Hoses.....	2-8
Adjusting Engine RPM (Idle).....	2-8
Engine/Transmission Oil - Filter.....	2-9
Front Differential/Rear Drive Lubricant.....	2-10
Tires.....	2-11
Steering Components.....	2-11
Driveshaft/Coupling.....	2-11
Suspension/Shock Absorbers/Bushings.....	2-11
Nuts/Bolts/Cap Screws.....	2-12
Ignition Timing.....	2-12
Headlight/Taillight-Brakelight.....	2-12
Switches.....	2-13
Low Range/High Range/Neutral/Reverse Lever....	2-13
Frame/Welds.....	2-14
Electrical Connections.....	2-14
Hydraulic Brake System.....	2-14
Parking Brake.....	2-16
Burnishing Brake Pads.....	2-18
Coolant.....	2-18
Checking/Replacing V-Belt.....	2-18

# Periodic Maintenance Chart

A = Adjust  
C = Clean  
D = Drain

I = Inspect  
L = Lubricate  
R = Replace  
T = Tighten

Item	Initial Service After Break-In (First Mo or 100 Mi)	Every Day	Every Month or Every 100 Miles	Every 3 Months or Every 300 Miles	Every 6 Months or Every 500 Miles	Every Year or Every 1500 Miles	As Needed
Battery	I		I				C
Fuses				I			R
Air Filter/Drain Tube	I	I	C*				R
Valve/Tappet Clearance	I				I		A
Engine Compression						I	
Spark Plug	I			I	I		R (4000 Mi or 18 Mo)
Muffler/Spark Arrester					C		R
Gas/Vent Hoses	I	I					R (2 Yrs)
Throttle Cable Ends/Accelerator Pedal Pivot	I	I			C-L		A-R
Carb Float Chamber				D*			
Engine RPM (Idle)	I				I		A
Engine-Transmission Oil Level		I					A
Engine-Transmission Oil/Filter	R			R*			R
Oil Strainer	I				I		C
Front Differential/Rear Drive Lubricant	I		I				R (4 Yrs)
Tires/Air Pressure	I	I					R
Steering Components	I	I		I			R
V-Belt	I				I		R
Suspension (Ball joint boots, drive axle boots front and rear, tie rods, differential and rear drive bellows)	I	I					R
Nuts/Bolts/Cap Screws	T		T				A
Ignition Timing						I	
Headlight/Taillight-Brakelight	I	I					R
Switches	I	I					R
Shift Lever					I		A-L
Gauges/Indicators	I	I					R
Frame/Welds	I		I		I		
Electrical Connections					I		C
Complete Brake System (Hydraulic & Parking)	I	I					
Brake Pads	I			I*			R
Brake Fluid	I			I			R (2 Yrs)
Brake Hoses	I			I			R (4 Yrs)
Coolant/Cooling System	I		I				R (2 Yrs)
Wheel Lug Nuts	T			T			

\* Service/Inspect more frequently when operating in adverse conditions.



## Lubrication Points

It is advisable to lubricate certain components periodically to ensure free movement. Apply light oil to the components using the following list as reference.

- A. Accelerator Pedal Pivot/Cable Ends
- B. Brake Pedal Pivot
- C. Parking Brake Cable Ends
- D. Shift Linkage
- E. Differential Lock Cable End (XT)
- F. Idle RPM Screw (Carburetor)

## Battery



The level of the battery fluid must be kept between the upper and lower level lines at all times. If the level drops below the lower level line, add only **distilled water** until it reaches upper level line.

### ⚠ WARNING

**Battery acid is harmful if it contacts eyes, skin, or clothing. Care must be taken whenever handling a battery.**

If the battery is discharged, remove the battery from the vehicle and charge the battery at the standard charging rate of 1.5 amps for 10 hours.

To remove and charge the battery, use the following procedure.

### ⚠ WARNING

**Anytime service is performed on a battery, the following must be observed: keep sparks, open flame, cigarettes, or any other flame away. Always wear safety glasses. Protect skin and clothing when handling a battery. When servicing battery in enclosed space, keep the area well-ventilated. Make sure battery venting is not obstructed.**

1. Remove the fasteners holding the left-rear splash panel in place; then remove the battery access panel.

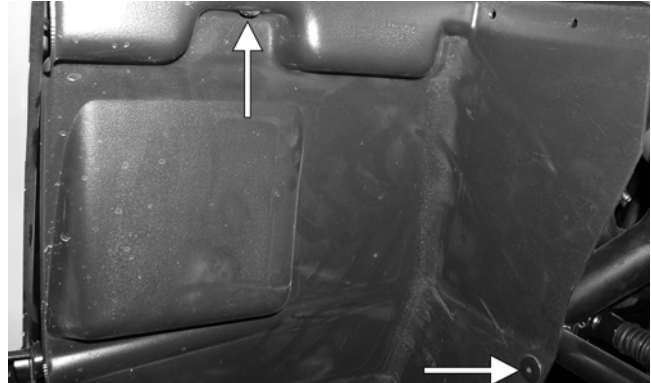

PR054A

2. Remove the negative battery cable; then remove the positive cable and the battery vent tube. Remove the battery from the vehicle. Care should be taken not to damage the vent tube.

### ⚠ WARNING

**Avoid spillage and contact with skin, eyes, and clothing.**

### ⚠ CAUTION

**Do not charge the battery while it is in the vehicle with the battery terminals connected.**

3. Remove the vent plugs; then (if necessary) fill the battery with **distilled water** to the UPPER level indicated on the battery.

■ **NOTE:** Electrolyte should be at room temperature before filling. Do not use water or any other liquid to activate a battery.

### ⚠ WARNING

**Electrolyte is a sulfuric acid solution. Avoid spillage and contact with skin, eyes, and clothing.**

4. Allow the battery to stand for 15-30 minutes after filling. Electrolyte level may fall during this time. Refill with electrolyte to UPPER level line.

- Trickle charge the battery at 1.5 amps for 10 hours.

**CAUTION**  
Never exceed the standard charging rate.

- After charging, check fluid level and fill with distilled water as necessary; then install vent plugs.

**CAUTION**  
Before installing the battery, make sure the ignition switch is in the OFF position.

- Attach the vent tube and check the vent tube to make sure it is not crimped or obstructed in any way and that it is properly routed through and secured to the frame.
- Connect cables to the proper terminals: positive cable to the positive terminal (+) and negative cable to the negative terminal (-). Connect the negative cable last.

**CAUTION**  
Connecting cables in reverse (positive to negative and negative to positive) can cause serious damage to the electrical system.

- Place the battery into position in the vehicle and secure with the battery access panel.

## Fuses

The main fuses are located in a power distribution module under the operator's seat.

If there is any type of electrical system failure, always check the fuses first.

**NOTE:** To remove the fuse, compress the locking tabs on either side of the fuse case and lift out.

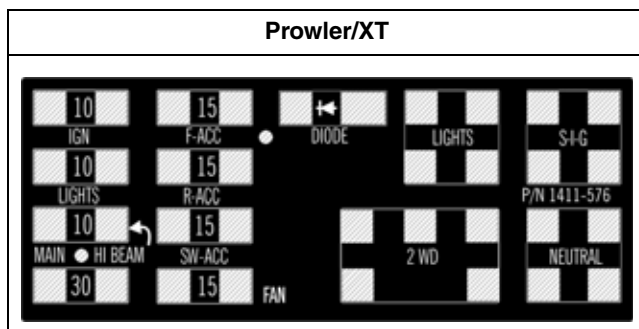

1411-576

**CAUTION**  
Always replace a blown fuse with a fuse of the same type and rating.

## Air Cleaner/Filter

The air filter inside the air filter housing must be kept clean to provide good engine power and gas mileage. If the vehicle is used under normal conditions, service the filter at the intervals specified. If operated in dusty, wet, or muddy conditions, inspect and service the filter more frequently. Use the following procedure to remove the filter and inspect and/or clean it.

### CLEANING AND INSPECTING FILTER

**CAUTION**  
Failure to inspect the air filter frequently if the vehicle is used in dusty, wet, or muddy conditions can damage the engine.

- Remove the seats; then remove the center console.
- Unsnap the four fasteners securing the air cleaner housing cover and remove the cover.
- Remove the air filter/filter screen assembly and separate the foam filter from the screen.



PR101

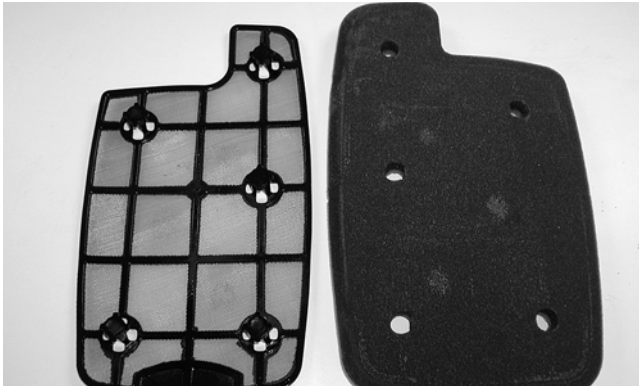

CD747

4. Fill a wash pan larger than the filter with a non-flammable cleaning solvent; then dip the filter in the solvent and wash it.

■ **NOTE: Foam Filter Cleaner and Foam Filter Oil are available from Arctic Cat.**

5. Dry the filter.

6. Put the filter in a plastic bag; then pour in air filter oil and work the filter. Reattach the filter to the filter screen.

**CAUTION**

A torn air filter can cause damage to the vehicle engine. Dirt and dust may get inside the engine if the element is torn. Carefully examine the element for tears before and after cleaning it. Replace the element with a new one if it is torn.

7. Clean any dirt or debris from inside the air cleaner. Be sure no dirt enters the carburetor.

8. Place the filter assembly in the air filter housing making sure it is properly positioned and properly seated with the filter screen down.



PR090

9. Install the air filter housing cover and secure with the retaining clips; then install the center console and seats making sure the seats lock securely.

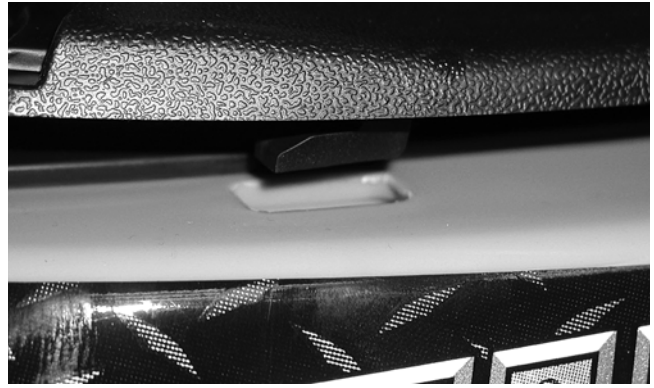

CD670

**CHECKING AND CLEANING DRAINS**

1. Inspect one-way drains beneath the main housing for debris and for proper sealing.

**2**

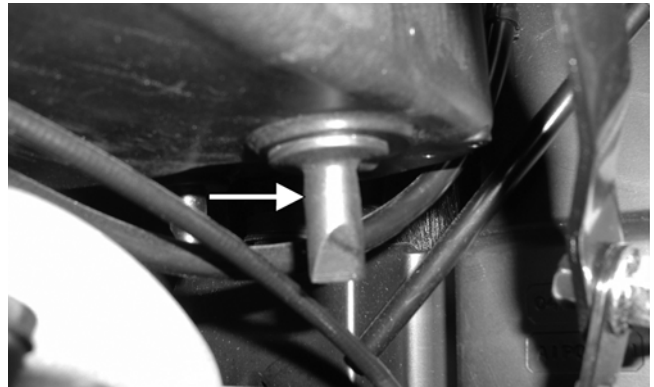

PR141A

2. Replace any one-way drain that is cracked or shows any signs of hardening or deterioration.

**CAUTION**

The one-way drain to the left is the clean air section of the filter housing. Any leak of this one-way drain will allow dirt into the engine intake causing severe engine damage.

3. Wipe any accumulation of oil or gas from the filter housing and one-way drains.



## Valve/Tappet Clearance (Feeler Gauge Procedure)

To check and adjust valve/tappet clearance, use the following procedure.

■ **NOTE:** The engine must be cold for this procedure.

■ **NOTE:** The seats, center console, spark plug, and air filter housing must be removed for this procedure.

1. Remove the timing inspection plug; then remove the tappet covers (for more detailed information, see Section 3 - Servicing Top-Side Components).
2. Rotate the crankshaft to the TDC position on the compression stroke.

■ **NOTE:** At this point, the rocker arms and adjuster screws must not have pressure on them.

3. Using a feeler gauge, check each valve/tappet clearance. If clearance is not within specifications, loosen the jam nut and rotate the tappet adjuster screw until the clearance is within specifications. Tighten each jam nut securely after completing the adjustment.

### ⚠ CAUTION

The feeler gauge must be positioned at the same angle as the valve and valve adjuster for an accurate measurement of clearance. Failure to measure the valve clearance accurately could cause valve component damage.

#### VALVE/TAPPET CLEARANCE

Intake	0.1016 mm (0.004 in.)
Exhaust	0.1524 mm (0.006 in.)

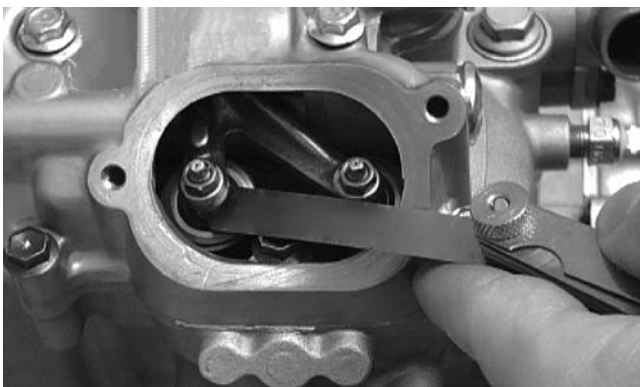

CC007D

4. Install the spark plug; then install the timing inspection plug.
5. Place the two tappet covers with O-rings into position. Tighten the cap screws securely.

## Valve/Tappet Clearance (Valve Adjuster Procedure)

To check and adjust valve/tappet clearance, use the following procedure.

■ **NOTE:** The engine must be cold for this procedure.

■ **NOTE:** The seats, center console, spark plug, and air filter housing must be removed for this procedure.

1. Remove the timing inspection plug; then remove the tappet covers (for more detailed information, see Section 3 - Servicing Top-Side Components).
2. Rotate the crankshaft to the TDC position on the compression stroke.

■ **NOTE:** At this point, the rocker arms and adjuster screws must not have pressure on them.

■ **NOTE:** Use Valve Clearance Adjuster (p/n 0444-078) for this procedure.

3. Place the valve adjuster onto the jam nut securing the tappet adjuster screw; then rotate the valve adjuster dial clockwise until the end is seated in the tappet adjuster screw.
4. While holding the valve adjuster dial in place, use the valve adjuster handle and loosen the jam nut; then rotate the tappet adjuster screw clockwise until friction is felt.
5. Align the valve adjuster handle with one of the marks on the valve adjuster dial.
6. While holding the valve adjuster handle in place, rotate the valve adjuster dial counter-clockwise until proper valve/tappet clearance is attained.

■ **NOTE:** Refer to the appropriate specifications in Feeler Gauge Procedure sub-section for the proper valve/tappet clearance.

■ **NOTE:** Rotating the valve adjuster dial counter-clockwise will open the valve/tappet clearance by 0.05 mm (0.002 in.) per mark.

7. While holding the adjuster dial at the proper clearance setting, tighten the jam nut securely with the valve adjuster handle.
8. Place the two tappet covers with O-rings into position. Tighten the cap screws securely.

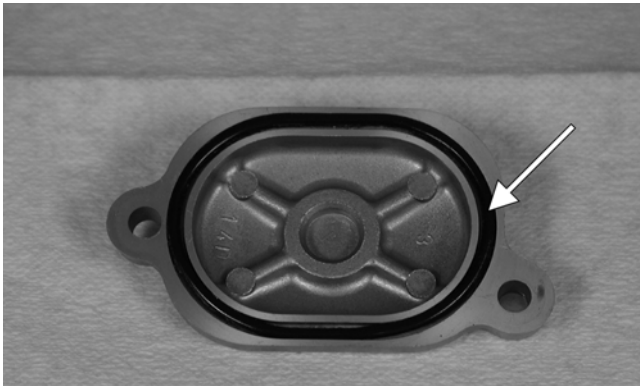

CF006A

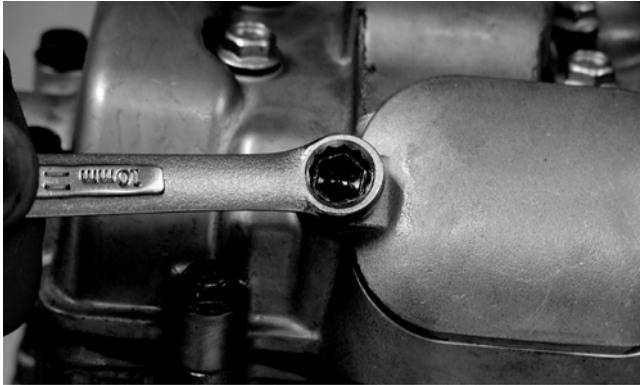

CF005

9. Install the spark plug; then install the timing inspection plug.

---

---

## Testing Engine Compression

---

To test engine compression, use the following procedure.

■ **NOTE:** The engine must be warm and the battery must be fully charged for this test.

■ **NOTE:** The seats and center console must be removed for this procedure.

1. Remove the high tension lead from the spark plug.
2. Using compressed air, blow any debris from around the spark plug.

### **WARNING**

**Always wear safety glasses when using compressed air.**

3. Remove the spark plug; then attach the high tension lead to the plug and ground the plug on the cylinder head well away from the spark plug hole.
4. Attach the Compression Tester Kit (p/n 0444-213).
5. While holding the throttle in the full-open position, crank the engine over with the electric starter until the gauge shows a peak reading (five to 10 compression strokes).

■ **NOTE:** The compression should be within a range of 63-77 psi in the full-open throttle position.

6. If compression is abnormally low, inspect the following items.
  - A. Starter cranks engine over.
  - B. Gauge is functioning properly.
  - C. Throttle lever in the full-open position.
  - D. Valve/tappet clearance correct.
  - E. Valve bent or burned.
  - F. Valve seat burned.

■ **NOTE:** To service valves, see Section 3.

7. Pour 29.5 ml (1 fl oz) of oil into the spark plug hole, reattach the gauge, and retest compression.
8. If compression is now evident, service the piston rings (see Section 3).

---

---

## Spark Plug

---

A light brown insulator indicates that the plug is correct. A white or dark insulator indicates that the engine may need to be serviced or the carburetor may need to be adjusted. To maintain a hot, strong spark, keep the plug free of carbon.

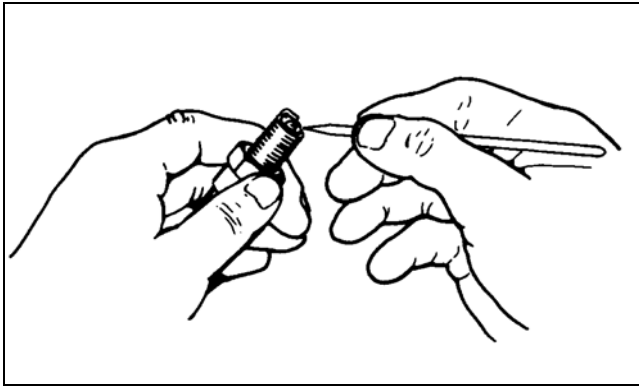

ATV-0051

**CAUTION**

Before removing the spark plug, be sure to clean the area around the spark plug. Dirt could enter engine when removing or installing the spark plug.

Adjust the gap to 0.7-0.8 mm (0.028-0.032 in.).

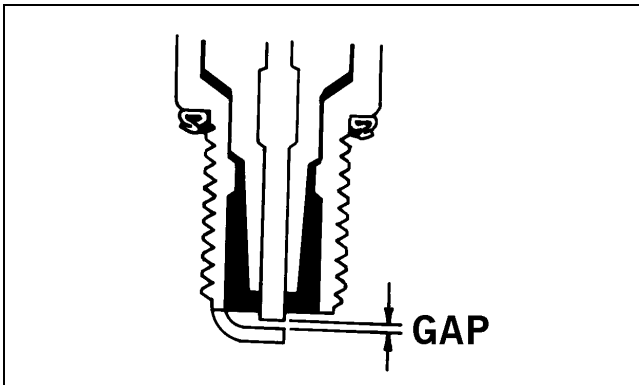

ATV0052B

When installing the spark plug, be sure to tighten it securely. A new spark plug should be tightened 1/2 turn once the washer contacts the cylinder head. A used spark plug should be tightened 1/8-1/4 turn once the washer contacts the cylinder head.

## Muffler/Spark Arrester

The muffler has a spark arrester which must be periodically cleaned. At the intervals shown in the Periodic Maintenance Chart, clean the spark arrester using the following procedure.

**WARNING**

Wait until the muffler cools to avoid burns.

1. Remove the three cap screws securing the spark arrester screen assembly to the muffler; then loosen and remove the spark arrester. Account for a gasket.

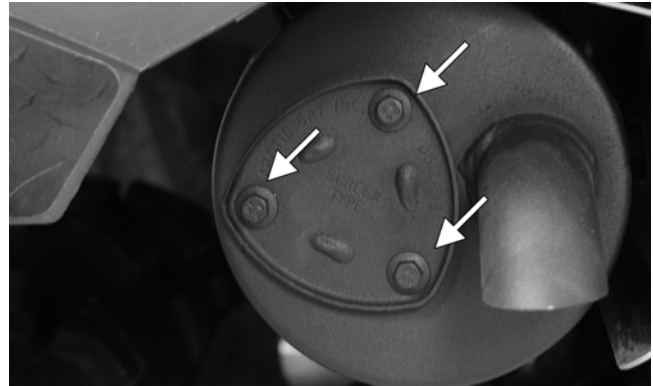

CF105A

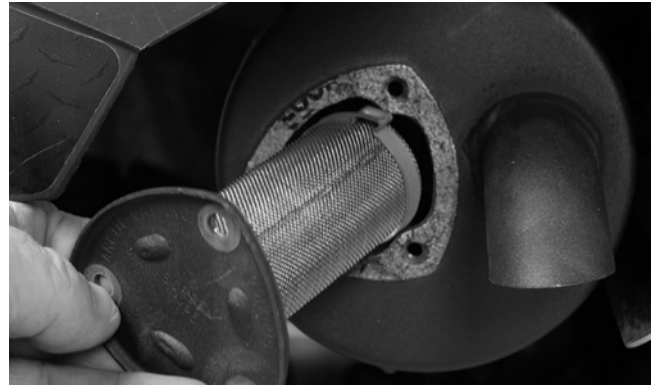

CF104

2. Using a suitable brush, clean the carbon deposits from the screen taking care not to damage the screen.

**NOTE:** If the screen or gasket is damaged in any way, it must be replaced.

3. Install the spark arrester assembly and gasket and secure with the three cap screws. Tighten the cap screws to 0.6 kg-m (4.0 ft-lb).

## Gas/Vent Hoses

Replace the gas hose every two years. Damage from aging may not always be visible. Do not bend or obstruct the routing of the carburetor vent hose. Make certain that the vent hose is securely connected to the carburetor and the opposite end is always open.

## Adjusting Engine RPM (Idle)

To properly adjust the idle RPM, a tachometer is necessary. To adjust idle RPM, use the following procedure.

■ **NOTE:** To access the idle adjustment screw, it will be necessary to remove the seats and center console. The idle adjustment screw is located on the left-side of the carburetor.

1. Set the parking brake. With the transmission in neutral, start the engine and warm it up to normal operating temperature.
2. Turn the idle adjustment screw clockwise one turn past the recommended RPM setting; then turn it counterclockwise to 1250-1350 RPM.

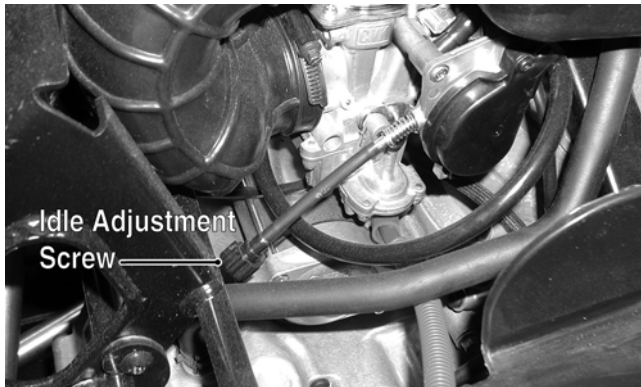

PR081A

**⚠ WARNING**

Adjust the idle to the correct RPM. Make sure the engine is at normal operating temperature before adjusting the idle RPM.

## Engine/Transmission Oil - Filter

### OIL - FILTER

Change the engine oil and oil filter at the scheduled intervals. The engine should always be warm when the oil is changed so the oil will drain easily and completely.

■ **NOTE:** To change oil and filter, the seats and center console must be removed.

1. Park the vehicle on level ground.
2. Remove the oil level stick/filler plug.



PR053B

3. Remove the drain plug from the bottom of the engine and drain the oil into a drain pan.

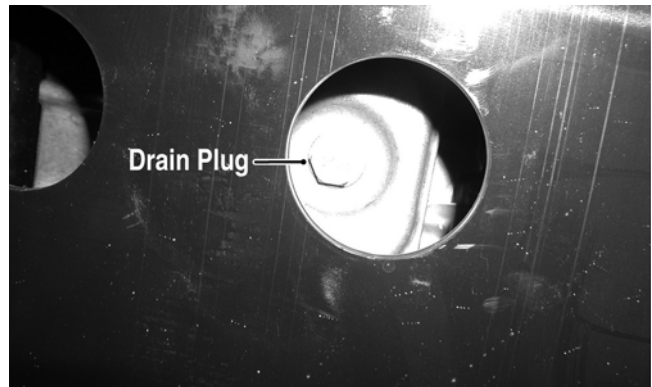

PR078A

**2**

4. Using the Oil Filter Wrench (p/n 0644-389) and a ratchet handle (or a socket or box-end wrench), remove the old oil filter.

■ **NOTE:** Clean up any excess oil after removing the filter.

5. Apply oil to a new filter O-ring and check to make sure it is positioned correctly; then install the new oil filter. Tighten securely.
6. Install the engine drain plug and tighten to specifications. Pour the specified amount of the recommended oil in the filler hole. Install the oil level stick/filler plug.

**⚠ CAUTION**

Any oil used in place of the recommended oil could cause serious engine damage. Do not use oils which contain graphite or molybdenum additives. These oils can adversely affect clutch operation. Also, not recommended are racing, vegetable, non-detergent, and castor-based oils.

7. Start the engine (while the vehicle is outside on level ground) and allow it to idle for a few minutes.
8. Turn the engine off and wait approximately one minute.



9. Unscrew the oil level stick and wipe it with a clean cloth.
  10. Install the oil level stick until the threads touch engine case.
- **NOTE:** The oil level stick should not be threaded into the case for checking the oil level.
11. Remove the oil level stick; the engine oil level should be above the illustrated "L" mark but not higher than the illustrated "F" mark.

**CAUTION**

Do not over-fill the engine with oil. Always make sure that the oil level is above the "L" mark but not higher than the "F" mark.

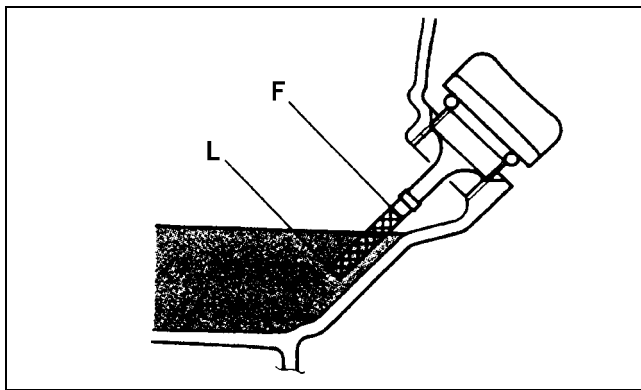

ATV-0100

12. Inspect the area around the drain plug and oil filter for leaks.

## Front Differential/Rear Drive Lubricant

Check and change the lubricant according to the Periodic Maintenance Chart. When changing the lubricant, use approved SAE 80W-90 hypoid gear lube. To check lubricant, use the following procedure.

1. Remove the fill/level plug; the lubricant level should be 1 in. below the plug threads.

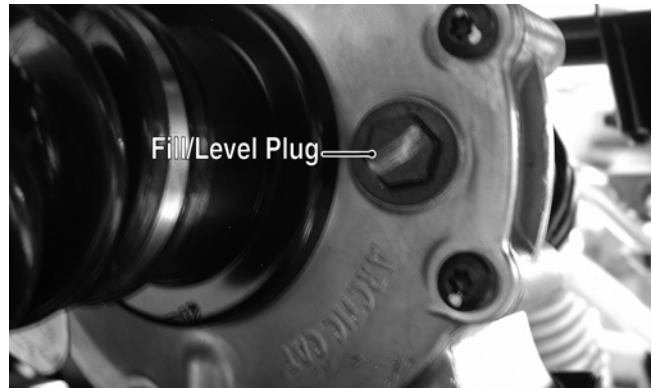

PR046A

2. If low, add SAE approved 80W-90 hypoid gear lube as necessary.

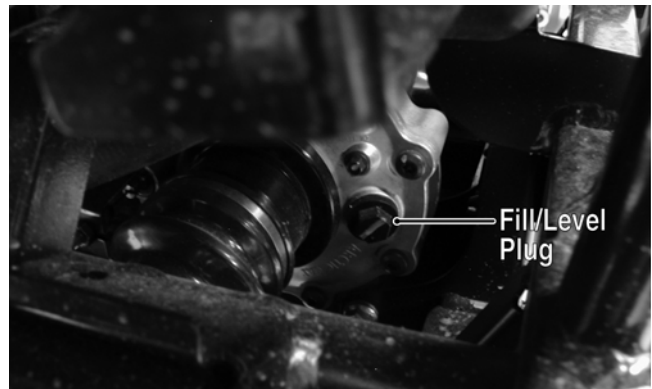

PR065A

To change the lubricant, use the following procedure.

1. Place the vehicle on level ground.
2. Remove each fill/level plug.
3. Drain the lubricant into a drain pan by removing in turn the drain plug from each.

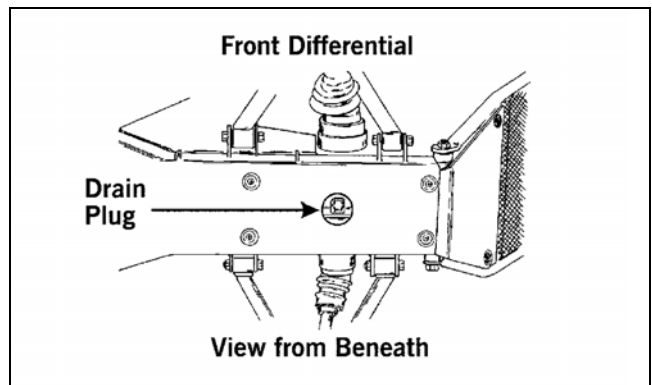

ATV0082A



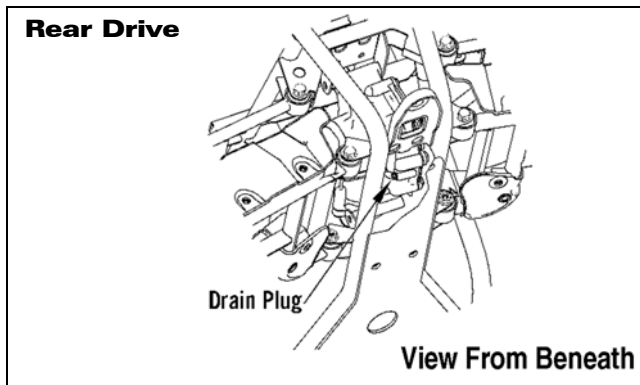

737-651A

4. After all the lubricant has been drained, install the drain plugs and tighten to specifications (see Section 10).
5. Pour the appropriate amount of recommended lubricant into the fill/level hole.
6. Install the fill/level plugs.

■ **NOTE:** If the differential/rear drive lubricant is contaminated with water, inspect the drain plug, fill/level plug, and/or bladder.

---

## Tires

---

### TIRE SIZES

The Prowler/XT models are equipped with low-pressure tubeless tires of the size and type listed (see Section 1). Do not under any circumstances substitute tires of a different type or size.

### ⚠ WARNING

Always use the size and type of tires specified.  
Always maintain proper tire inflation pressure.

### TIRE INFLATION PRESSURE

Front and rear tire inflation pressure should be 0.70 kg-cm<sup>2</sup> (10 psi).

A low-pressure gauge is provided in the tool kit to measure the air pressure in the tires. Check the air pressure in all tires before each use of the vehicle.

---

## Steering Components

---

The following steering components should be inspected periodically to ensure safe and proper operation.

- A. Steering wheel secure.
- B. Steering has equal and complete full-left and full-right capability.
- C. Steering sector mounting bolts tight.
- D. Ball joints not worn, cracked, or damaged.
- E. Tie rods not bent or cracked.
- F. Knuckles not worn, cracked, or damaged.
- G. Cotter pins not damaged or missing.

---

## Driveshaft/Coupling

---

2

The following drive system components should be inspected periodically to ensure proper operation.

- A. Spline lateral movement (slop).
- B. Coupling cracked, damaged, or worn.
- C. Universal joints worn or missing bearings.

---

## Suspension/Shock Absorbers/Bushings

---

The following suspension system components should be inspected periodically to ensure proper operation.

- A. Shock absorber rods bent, pitted, or damaged.
- B. Rubber damper cracked, broken, or missing.
- C. Shock absorber body damaged, punctured, or leaking.
- D. Shock absorber eyelets broken, bent, or cracked.
- E. Shock absorber eyelet bushings worn, deteriorated, cracked, or missing.
- F. Shock absorber spring broken or sagging.
- G. Sway bar mountings tight and bushings secure.

---



---

## Nuts/Bolts/Cap Screws

---

Tighten all nuts, bolts, and cap screws. Make sure rivets holding components together are tight. Replace all loose rivets. Care must be taken that all calibrated nuts, bolts, and cap screws are tightened to specifications. For proper torque values, see Section 10.

---



---

## Ignition Timing

---

The ignition timing cannot be adjusted; however, verifying ignition timing can aid in troubleshooting other components. To verify ignition timing, use the following procedure.

■ **NOTE:** To check ignition timing, the seats and center console must be removed.

1. Attach the Timing Light (p/n 0644-296) to the spark plug high tension lead; then remove the timing inspection plug from the left-side crankcase cover.
2. Start the engine and using the RPM function on the speedometer/tachometer (XT) or using a suitable tachometer (Prowler), run at 1500 RPM; ignition timing should be 10° BTDC.
3. Install the timing inspection plug.

If ignition timing cannot be verified, the rotor may be damaged, the key may be sheared, the trigger coil bracket may be bent or damaged, or the CDI unit may be faulty.

---



---

## Headlight/Taillight-Brakelight

---

Each time the vehicle is used, lights should be checked for proper function. With the ignition switch in the ON position, select the high and/or low beam on the light switch; the headlights and taillight should illuminate. Test the brakelight by depressing the brake pedal. The brakelight should illuminate.

## HEADLIGHT

■ **NOTE:** The bulb portion of the headlight is fragile. **HANDLE WITH CARE.** When replacing the headlight bulb, do not touch the glass portion of the bulb. If the glass is touched, it must be cleaned with a dry cloth before installing. Skin oil residue on the bulb will shorten the life of the bulb.

### **WARNING**

**Do not attempt to remove the bulb when it is hot. Severe burns may result.**

To replace the headlight bulb, use the following procedure.

1. Remove the wiring harness connector from the back of the headlight.
2. Grasp the bulb socket, turn it counterclockwise and remove, and pull the bulb straight out of the socket.
3. Install the new bulb into the socket and rotate it completely clockwise in the housing.
4. Install the wiring harness connector.

## TAILLIGHT-BRAKELIGHT

To replace the taillight-brakelight bulb, use the following procedure.

1. Remove the two machine screws and remove the light assembly.
2. Rotate the bulb socket counterclockwise to remove it from the light assembly; then pull straight out on the bulb. Push the new bulb straight into the socket.
3. Install the bulb and socket into the light assembly and turn clockwise to lock in place.
4. Install the taillight-brakelight assembly on the canopy support.

## CHECKING/ADJUSTING HEADLIGHT AIM

The headlights can be adjusted vertically. The geometric center of the HIGH beam light zone is to be used for vertical aiming.

1. Position the vehicle on a level floor so the headlights are approximately 6.1 m (20 ft) from an aiming surface (wall or similar aiming surface).

■ **NOTE:** There should be an average operating load on the vehicle when adjusting the headlight aim.

2. Measure the distance from the floor to the mid-point of each headlight.
3. Using the measurements obtained in step 2, make horizontal marks on the aiming surface.
4. Make vertical marks which intersect the horizontal marks on the aiming surface directly in front of the headlights.
5. Switch on the lights. Make sure the HIGH beam is on. DO NOT USE LOW BEAM.
6. Observe each headlight beam aim. Proper aim is when the most intense beam is centered on the vertical mark 5 cm (2 in.) below the horizontal mark on the aiming surface.

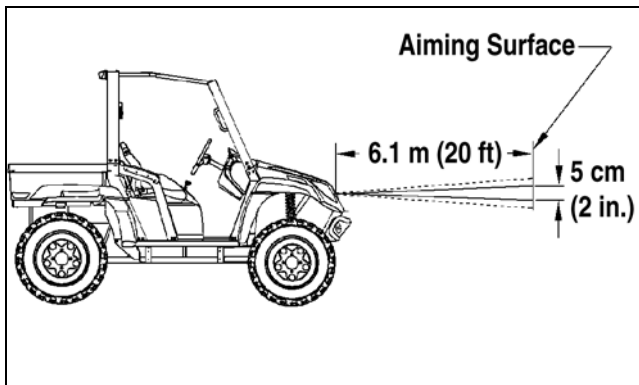

0740-647

7. Using the adjuster knob, adjust each headlight until correct aim is obtained.

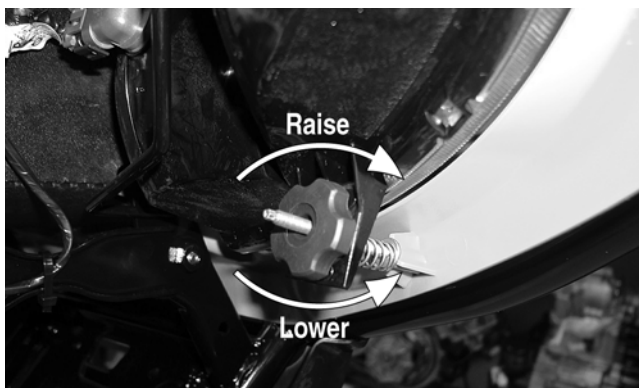

CD714A

## Switches

Each time the vehicle is used, switches should be checked for proper operation. Use the following list for reference.

- A. Ignition/start switch — engine will run; starter will engage.

- B. 2WD/4WD selector switch — differential will engage (4WD)/disengage (2WD).
- C. Reverse/neutral/high/low switch — R/N/H/L will be indicated on the LCD.
- D. Headlight switch — high beam, low beam, and lights off can be selected.
- E. Brake switch — brakelight illuminates and starter can be engaged with vehicle in gear.

## Low Range/High Range/ Neutral/Reverse Lever

### CHECKING SHIFT LEVER LINKAGE

2

Set the parking brake and turn the ignition switch on; then with the shift lever in the neutral position, look for the (N) indication on the LCD. Shift into high range and look for the (H) indication, low range for the (L) indication, and reverse for the (R) indication. Shift the transmission into neutral and turn the ignition switch off.

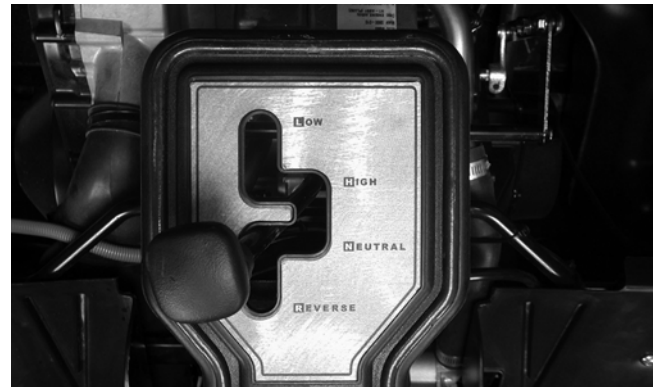

PR094

### ADJUSTING SHIFT LEVER LINKAGE

To adjust the shift lever linkage, use the following procedure.

1. Set the parking brake; then remove the seats and center console.
2. Make sure the shift lever is in neutral; then loosen the jam nut on the linkage.
3. Remove the E-clip on the transmission shift arm; then remove the linkage from the shift arm. Account for a washer and a bushing.

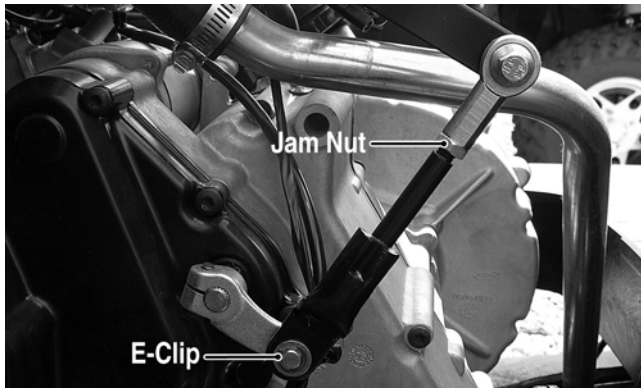

PR461A

4. Turn the linkage rod clockwise or counterclockwise until the lower linkage hole aligns with the shift arm pin.
5. Install the bushing and linkage and secure with the washer and E-clip; then tighten the jam nut securely. Check each gear shift position for proper gear selection and make sure the proper icon illuminates on the LCD.

---

---

## Frame/Welds

---

---

The frame and welds should be checked periodically for damage, bends, cracks, deterioration, broken components, and missing components. If replacement or repair constitutes removal, see Section 8.

---

---

## Electrical Connections

---

---

The electrical connections should be checked periodically for proper function. In case of an electrical failure, check fuses, connections (for tightness, corrosion, damage), and/or bulbs. If an electrical component needs to be tested for proper function, see Section 5.

---

---

## Hydraulic Brake System

---

---

### CHECKING/BLEEDING

The hydraulic brake system has been filled and bled at the factory. To check and/or bleed a hydraulic brake system, use the following procedure.

1. With the master cylinder in a level position, check the fluid level in the reservoir. If the level in the reservoir is not above the MIN, add DOT 4 brake fluid.



PR095

2. Depress the brake pedal several times to check for a firm brake. If the brake is not firm, the system must be bled.
3. To bleed the brake system, use the following procedure.
  - A. Remove the cover and fill the reservoir with DOT 4 Brake Fluid.
  - B. Install and secure the cover; then slowly depress the brake pedal several times.
  - C. Remove the protective cap, install one end of a clear hose onto one FRONT bleeder screw, and direct the other end into a container; then while holding slight pressure on the brake pedal, open the bleeder screw and watch for air bubbles. Close the bleeder screw before releasing the brake pedal. Repeat this procedure until no air bubbles are present.



AF637D



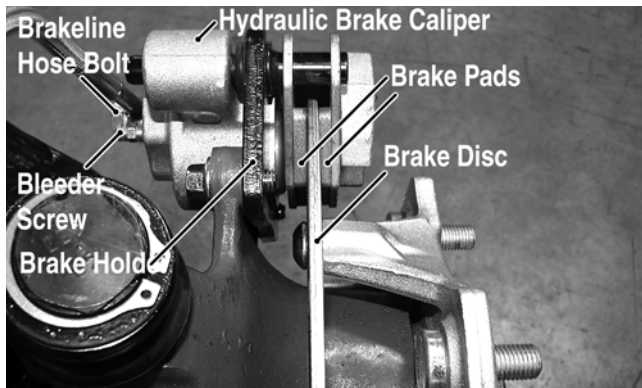

PR377A

■ **NOTE:** During the bleeding procedure, watch the reservoir very closely to make sure there is always a sufficient amount of brake fluid. When the level falls below MIN, refill the reservoir before the bleeding procedure is continued. Failure to maintain a sufficient amount of fluid in the reservoir will result in air in the system.

D. At this point, perform steps B and C on the other FRONT bleeder screw; then move to the REAR bleeder screw and follow the same procedure.

E. Repeat steps B and C until the brake pedal is firm.

4. Carefully check the entire hydraulic brake system that all hose connections are tight, the bleed screws are tight, the protective caps are installed, and no leakage is present.

 <b>CAUTION</b>
<p>This hydraulic brake system is designed to use DOT 4 brake fluid only. If brake fluid must be added, care must be taken as brake fluid is very corrosive to painted surfaces.</p>

### INSPECTING HOSES

Carefully inspect the hydraulic brake hoses for cracks or other damage. If found, the brake hoses must be replaced.

### CHECKING/REPLACING PADS

The clearance between the brake pads and brake discs is adjusted automatically as the brake pads wear. The only maintenance that is required is replacement of the brake pads when they show excessive wear. Check the thickness of each of the brake pads as follows.

1. Remove a front wheel.
2. Measure the thickness of each brake pad.

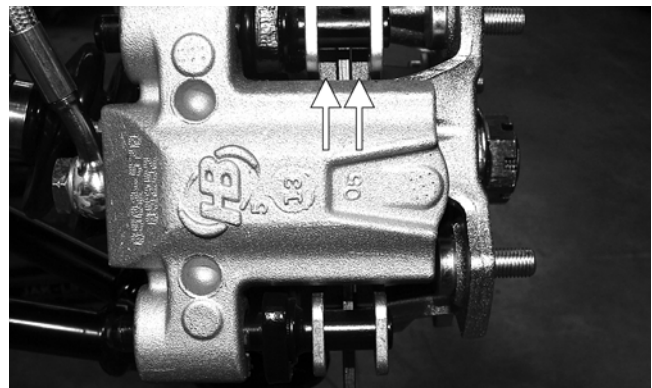

PR376A

3. If thickness of either brake pad is less than 1.0 mm (0.039 in.), the brake pads must be replaced.

■ **NOTE:** The brake pads should be replaced as a set.

4. To replace the brake pads, use the following procedure.

A. Remove the wheel.

B. Remove the cap screws securing the caliper holder to the knuckle; then remove the pads from the caliper.



PR237

C. Install the new brake pads.

D. Secure the caliper holder to the knuckle with the cap screws. Tighten to specifications (see Section 10).

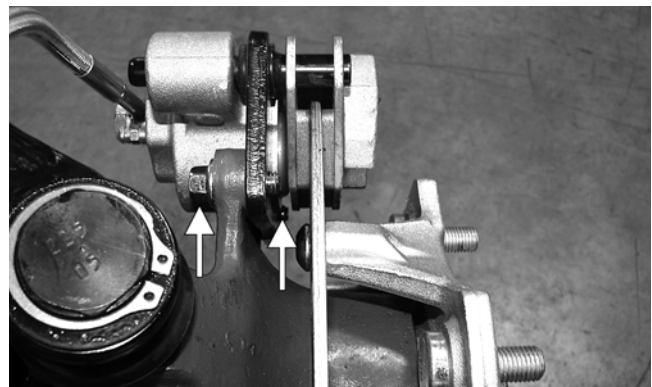

PR377B



E. Install the wheel. Tighten to specifications (see Section 10).

5. Burnish the brake pads (see Burnishing Brake Pads in this section).

---

---

## Parking Brake

---

---

### CHECKING

Although the parking brake has been adjusted at the factory, the brake should be checked for proper operation. The brake must be maintained to be fully functional.

1. With the engine off, transmission in neutral, and the parking brake set, attempt to move the vehicle.
2. If the rear wheels are locked, it is adjusted properly.
3. If the rear wheels are not locked, it must be adjusted (set up).

### ADJUSTING

To adjust (set up) the parking brake, use the following procedure.

■ **NOTE:** Remove the four rear body screws securing the belly panel to the frame and allow it to drop down for better access to the parking brake actuator.

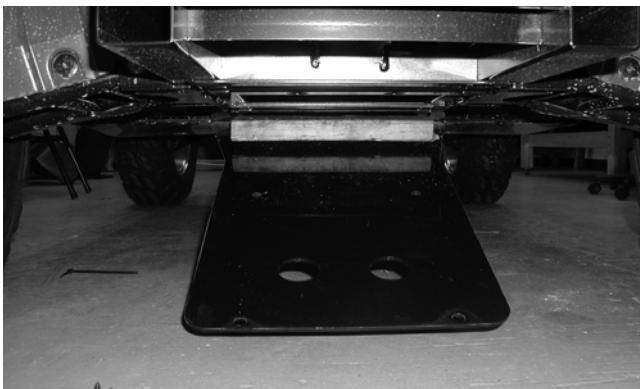

PR096

1. Remove the parking brake cable from the actuator lever; then remove the actuator nut and actuator lever. Note the position of the lever before removing.

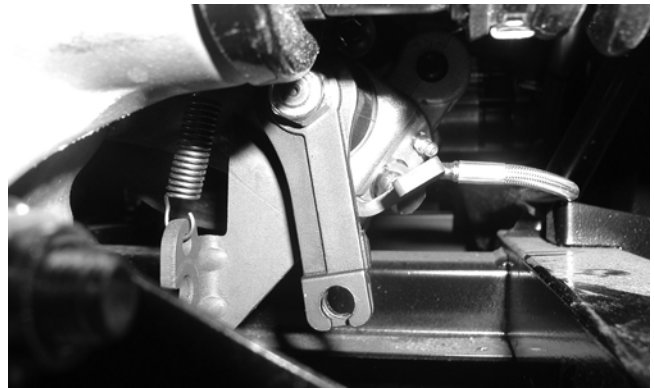

PR098

2. Rotate the actuator clockwise (hand tight) until it contacts the back of the piston; then rotate counterclockwise approximately one spline.

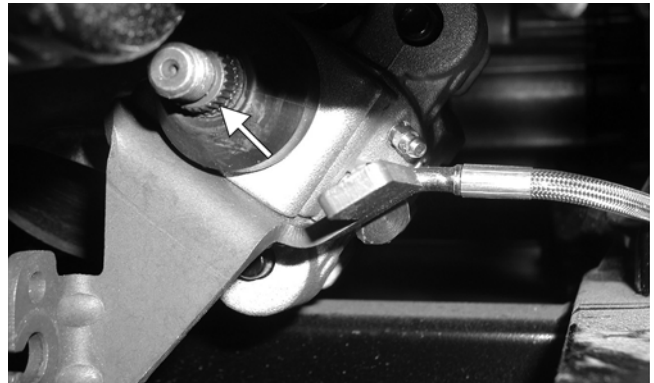

PR089A

3. Install the actuator lever in the position noted in step 1; then install the actuator nut and tighten to 4.8 kg-m (35 ft-lb).

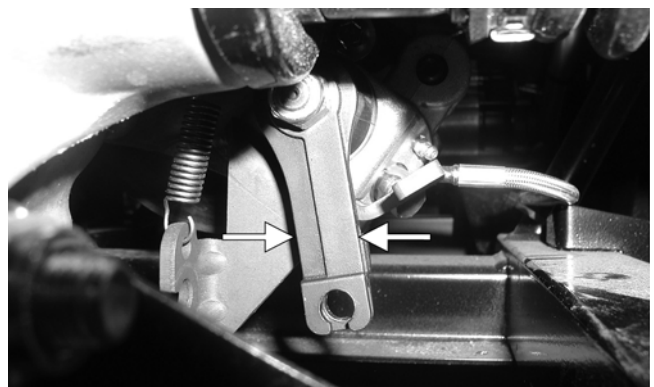

PR098A

4. Install the parking brake cable and adjust nuts so the parking brake holds the vehicle when set and fully releases it when released.

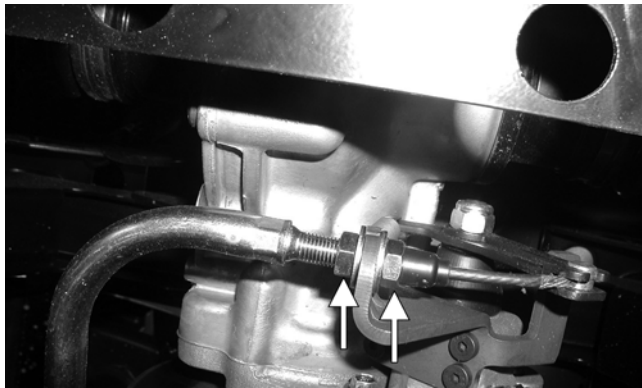

PR097A



PR466A

**⚠ CAUTION**

If after adjusting the parking brake cable the parking brake will not hold the vehicle, the brake pads must be replaced.

**MEASURING/REPLACING BRAKE PADS**

**Removing**

1. Remove the parking brake cable (see Adjusting in this sub-section).
2. Lift the cargo box; then disconnect the lift support and allow the cargo box to tilt all the way back.



PR099

3. Remove the two cap screws securing the brake caliper to the rear drive housing and remove the caliper.

4. Remove the anti-rattle springs; then push in on the caliper holder and remove the outer brake pad. Remove the inner pad.

**Inspecting and Measuring**

1. Inspect the pads for gouges, chips, or wear.
2. Inspect the disc for gouges, grooves, cracks, and warpage.
3. Using a calipers, measure the thickness of each brake pad.
4. If the thickness of either brake pad is less than 1.0 mm (0.039 in.), the brake pads must be replaced.

■ **NOTE:** The brake pads should be replaced as a set.

**Installing**

1. Place the brake pads into the caliper; then install the anti-rattle springs.

■ **NOTE:** The metal backing of the pad will be facing the actuator when installed properly.

2. Slide brake caliper assembly over the brake disc and into position on the knuckle; then secure the caliper with the cap screws tightened to specifications (see Section 10).
3. Connect the parking brake cable (see Adjusting in this sub-section).
4. Adjust the parking brake (see Adjusting in this sub-section).
5. Connect the lift support to the cargo box.

■ **NOTE:** Whenever installing new pads, the new pads must be burnished (see Burnishing Brake Pads in this section).

---

---

## Burnishing Brake Pads

---

Brake pads must be burnished to achieve full braking effectiveness. Braking distance will be extended until brake pads are properly burnished. To properly burnish the brake pads, use the following procedure.

**⚠ WARNING**

**Failure to properly burnish the brake pads could lead to premature brake pad wear or brake loss. Brake loss can result in severe injury.**

1. Choose an area large enough to safely accelerate the vehicle to 30 mph and to brake to a stop.
2. Accelerate to 30 mph; then depress the brake pedal to decelerate to 0-5 mph.
3. Repeat procedure five times until brake pads are burnished.
4. Adjust the parking brake (if necessary).
5. Verify that the brakelight illuminates when the brake pedal is depressed.

---

---

## Coolant

---

The cooling system should be inspected daily for leakage and damage. Also, the coolant level should be checked periodically.

When filling the cooling system, use premixed Arctic Cat Antifreeze. While the cooling system is being filled, air pockets may develop; therefore, run the engine for five minutes after the initial fill, shut the engine off, and then fill the cooling system to the bottom of the stand pipe in the radiator neck.

**⚠ CAUTION**

**After operating the vehicle for the initial 5-10 minutes, stop the engine, allow the engine to cool down, and check the coolant level. Add coolant as necessary.**

---

---

## Checking/Replacing V-Belt

---

### REMOVING

1. Remove the seats and center console; then remove the left-side seat-base.

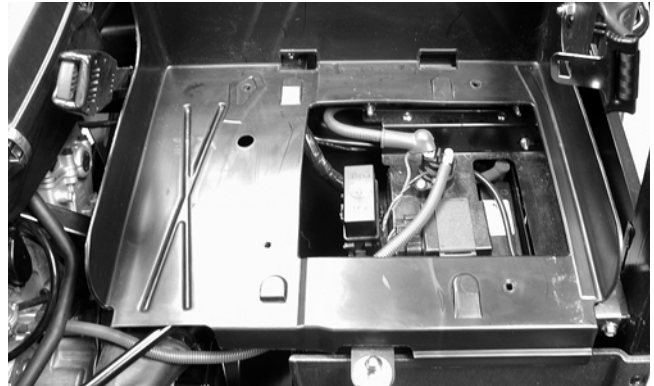

PR104

2. Remove the cap screws securing the V-belt cover noting the location of the different-lengthed cap screws for installing purposes; then using a rubber mallet, gently tap on the cover tabs to loosen the cover. Remove the cover.
3. Remove the nut securing the movable drive face; then remove the face. Account for the spacer.

**■ NOTE: Keep the drive face plate in contact with the drive face when removing or installing the drive face to prevent the rollers from falling out.**



PR110



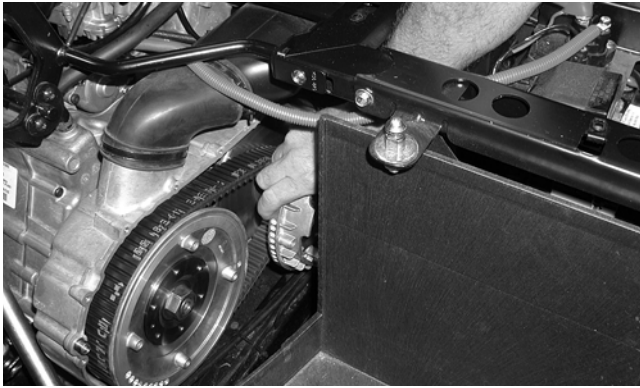

PR108

4. Install one of the V-belt cover cap screws into the driven pulley fixed face; then turn the driven pulley clockwise to spread the pulley faces. Remove the V-belt.



PR476A

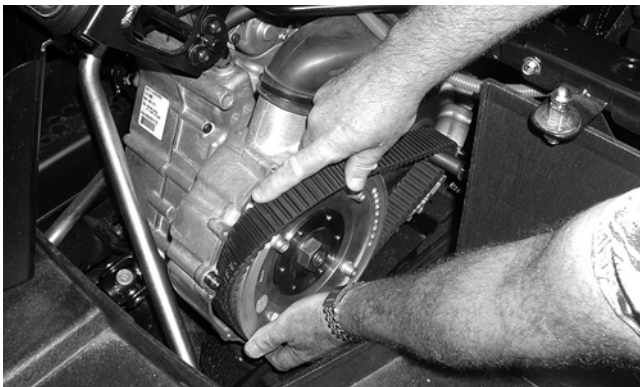

PR109

## INSTALLING

1. Place the V-belt into position on the driven pulley and over the front shaft.

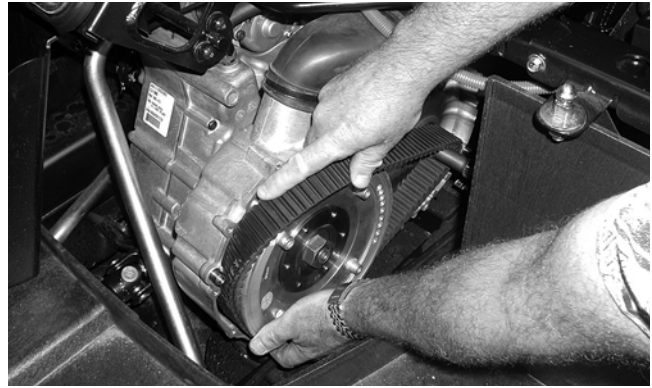

PR109

■ **NOTE:** The arrow on the V-belt should point rearward.

2. Pinch the V-belt together near its center and slide the spacer and movable drive face onto the drive shaft. Secure the drive face with a nut. Tighten the nut to specifications (see Section 10).

**2**

### CAUTION

Make sure the drive belt does not prevent the movable face from contacting the spacer when tightening the nut or false torque readings could occur. The assembly could loosen after starting the engine causing damage to the shaft and pulley.

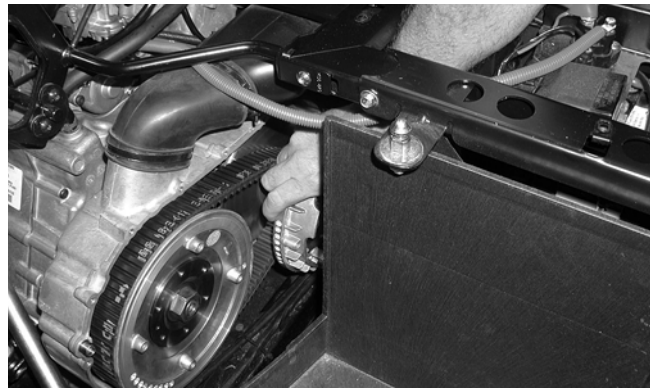

PR108

■ **NOTE:** At this point, remove the cap screw from the driven pulley fixed face.

3. Rotate the V-belt and driven pulley/clutch until the V-belt is flush with the top of the driven pulley.
4. Place the V-belt cover gasket into position; then install the cover and secure with the cap screws making sure the different-lengthed cap screws are in their proper location. Tighten the cap screws to specifications (see Section 10).
5. Secure the seat-base with the four cap screws. Tighten securely.
6. Install the seats and center console making sure the seats lock securely.

# SECTION 3 - ENGINE/TRANSMISSION

---

---

## TABLE OF CONTENTS

---

Engine/Transmission .....	3-2
Specifications .....	3-2
Prowler/XT (Table of Contents) .....	3-3



## Engine/Transmission

This section has been organized into sub-sections which show a progression for the complete servicing of the Arctic Cat Prowler/XT engine/transmission.

To service the center crankcase halves, the engine/transmission must be removed from the frame. To service top-side, left-side, and right-side components, the engine/transmission does not have to be removed from the frame.

■ **NOTE:** Arctic Cat recommends the use of new gaskets, lock nuts, and seals and lubricating all internal components when servicing the engine/transmission.

■ **NOTE:** Some photographs and illustrations used in this section are used for clarity purposes only and are not designed to depict actual conditions.

■ **NOTE:** Critical torque specifications are located in Section 10.

## Specifications\*

VALVES AND GUIDES		
Valve Face Diameter	(intake) (exhaust)	31.6 mm (1.24 in.) 27.9 mm (1.10 in.)
Valve/Tappet Clearance (cold engine)	(intake) (exhaust)	0.1016 mm (0.004 in.) 0.1524 mm (0.006 in.)
Valve Guide/Stem Clearance	(intake/exhaust)	0.013 mm (0.0005 in.)
Valve Guide/Valve Stem Deflection (wobble method)	(max)	0.35 mm (0.014 in.)
Valve Guide Inside Diameter		5.000-5.012 mm (0.1969-0.1973 in.)
Valve Stem Outside Diameter	(intake/exhaust)	4.972-4.987 mm (0.1957-0.1963 in.)
Valve Stem Runout	(max)	0.1 mm (0.0039 in.)
Valve Head Thickness	(min)	2.3 mm (0.0906 in.)
Valve Stem End Length	(min)	3.97 mm (0.156 in.)
Valve Face/Seat Width	(intake) (exhaust)	2.25 mm (0.0886 in.) 2.60 mm (0.1024 in.)
Valve Seat Angle	(intake/exhaust)	45° 15'-45° 30'
Valve Face Radial Runout	(max)	0.2 mm (0.0079 in.)
Valve Spring Free Length	(min)	38.7 mm (1.524 in.)
Valve Spring Tension @ 31.5 mm (1.24 in.)	(outer)	19.0 kg (42 lb)

CAMSHAFT AND CYLINDER HEAD		
Cam Lobe Height (min)	(intake/exhaust)	13.97 mm (0.55 in.)
Camshaft Journal Oil Clearance	(max)	0.04 mm (0.0016 in.)
Camshaft Journal Holder Inside Diameter	(right & center) (left)	21.98-22.04 mm (0.8654-0.8677 in.) 17.48-17.53 mm (0.6882-0.6902 in.)
Camshaft Journal Outside Diameter	(right & center) (left)	21.96-21.98 mm (0.8646-0.8654 in.) 17.47-17.48 mm (0.6878-0.6882 in.)
Camshaft Runout	(max)	0.05 mm (0.002 in.)
Rocker Arm Inside Diameter		12.000-12.018 mm (0.4724-0.4731 in.)
Rocker Arm Shaft Outside Diameter		11.97-11.98 mm (0.4713-0.4717 in.)
Cylinder Head/Cover Distortion	(max)	0.05 mm (0.002 in.)

CYLINDER, PISTON, AND RINGS		
Piston Skirt/Cylinder Clearance		0.045 mm (0.0018 in.)
Cylinder Bore		98 mm (3.858 in.)
Piston Diameter 15 mm from Skirt End	(0.6 in.)	97.948-97.962 mm (3.856-3.857 in.)
Piston Ring Free End Gap	(1st/2nd)	12.5 mm (0.492 in.)
Bore x Stroke		97.9 x 85 mm (3.86 x 3.35 in.)
Cylinder Trueness	(max)	0.01 mm (0.004 in.)
Piston Ring End Gap - Installed		0.36 mm (0.014 in.)
Piston Ring to Groove Clearance (max)	(1st/2nd)	0.03 mm (0.0012 in.)
Piston Ring Groove Width	(1st/2nd) (oil)	1.202-1.204 mm (0.0473-0.0474 in.) 2.01-2.03 mm (0.0791-0.0799 in.)
Piston Ring Thickness	(1st/2nd)	1.970-1.990 mm (0.0776-0.0783 in.)
Piston Pin Bore	(max)	23.0 mm (0.9055 in.)
Piston Pin Outside Diameter	(min)	22.99 mm (0.9051 in.)

CRANKSHAFT		
Connecting Rod (small end inside diameter)	(max)	23.021 mm (0.9063 in.)
Connecting Rod (big end side-to-side)		0.6 mm (0.024 in.)
Connecting Rod (big end width)		25 mm (0.9843 in.)
Connecting Rod @ 150 mm (5.9 in.) (small end deflection)	(max)	0.3 mm (0.0118 in.)
Crankshaft (web-to-web)		71 mm (2.79 in.)
Crankshaft Runout	(max)	0.03 mm (0.0012 in.)
Oil Pressure @ 2500 RPM (Cooling Fan Cycling)		1.40-2.11 kg/cm <sup>2</sup> (20-30 psi)
Cooling Fan Thermo-Switch Operating Temperature	(off→on) (on→off)	90°C (194°F) ±10% 75°C (167°F) ±10%
Engine Coolant Thermo-Switch Operating Temperature		107°-113°C (225°-235°F)

\* Specifications subject to change without notice.

## Prowler/XT (Table of Contents)

Removing Engine/Transmission .....	3-3
Top-Side Components.....	3-7
Removing Top-Side Components .....	3-7
Right-Side Components.....	3-11
Removing Right-Side Components.....	3-11
Left-Side Components .....	3-14
Removing Left-Side Components .....	3-14
Center Crankcase Components .....	3-18
Separating Crankcase Halves.....	3-18
Disassembling Crankcase Half .....	3-18
Servicing Components.....	3-20
Assembling Crankcase Half .....	3-36
Joining Crankcase Halves.....	3-38
Installing Left-Side Components .....	3-39
Installing Right-Side Components.....	3-42
Installing Top-Side Components .....	3-45
Installing Engine/Transmission.....	3-51

## Removing Engine/ Transmission

Many service procedures can be performed without removing the engine/transmission from the frame. Closely observe the note introducing each sub-section for this important information.

### 🔧 AT THIS POINT

If the technician's objective is to service/replace left-side cover oil seals (3), front output joint oil seal (1), rear output joint oil seal (1), and/or the oil strainer (from beneath the engine/ transmission), the engine/transmission does not have to be removed from the frame.

Support the vehicle on a suitable lift or jack stands allowing room to perform work from the underside.

■ **NOTE:** Locate the jack stands to allow removing of the center belly panel.

### ⚠️ WARNING

Make sure the vehicle is solidly supported on the support stands to avoid injury.

1. Remove the seats and center console; then remove the left-side and right-side seat-bases.
2. Remove the center belly panel; then drain the oil and coolant.

■ **NOTE:** Use a small funnel between the frame and coolant drain plug to prevent coolant from draining on the frame and splashing.

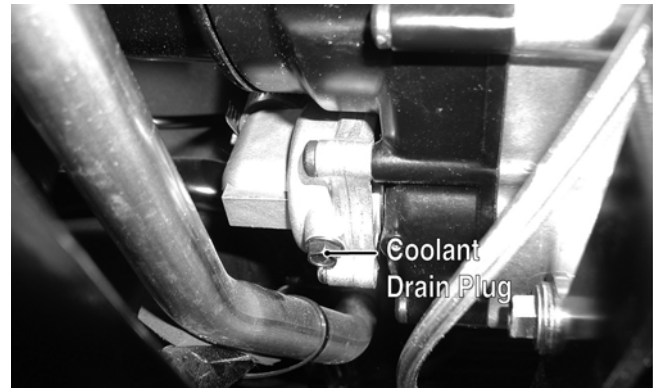

PR122A



PR156A

3

3. Remove the negative cable from the battery; then remove the positive cable.
4. From the left-side, remove the spark plug cap; then disconnect the temperature sensor lead, speed sensor connector (XT), fuel level sensor connector (XT), and reverse override switch connector.

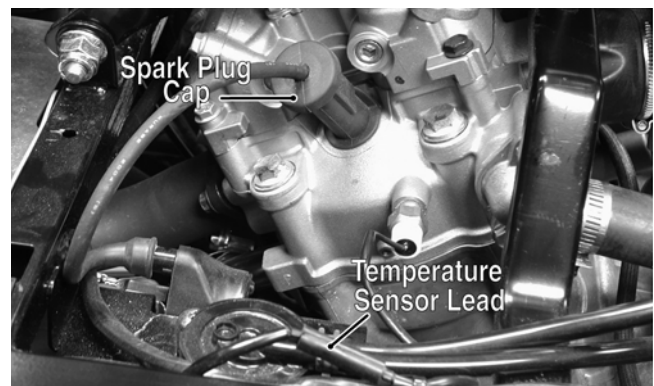

PR130A



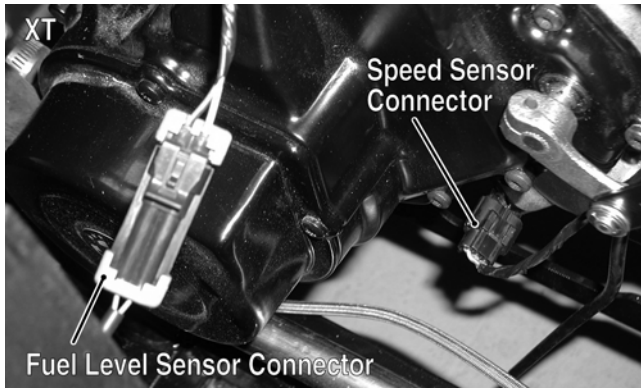

PR155B

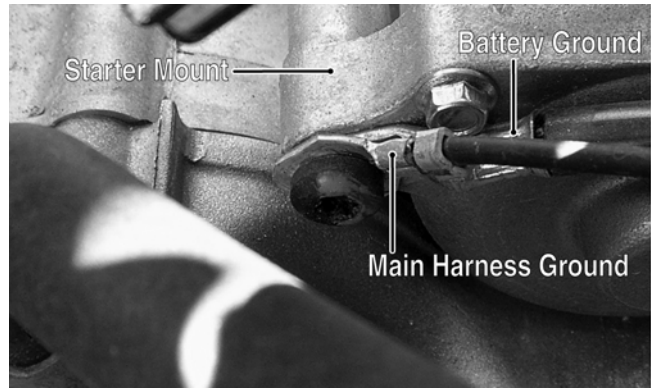

PR474A



PR157A

6. Remove the E-clip from the transmission shift arm; then disconnect the shifter linkage. Account for a washer and a bushing.

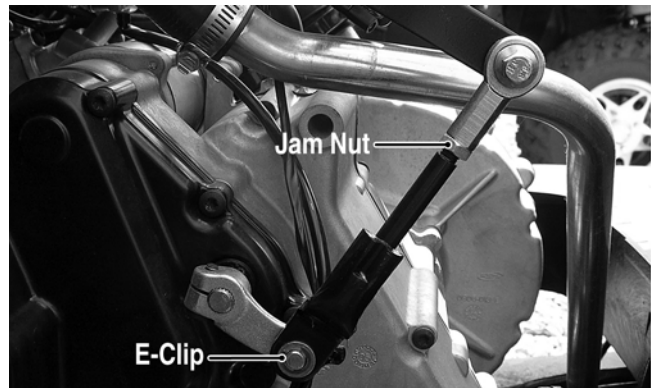

PR461A

5. From the left-side, disconnect the starter wire, alternator connector, CDI connector, shift position switch connector, and electric choke connector; then remove the cap screw securing the main harness ground and the battery ground wires to the starter.

7. Remove four machine screws securing the shifter mount to the frame; then remove the shifter assembly.

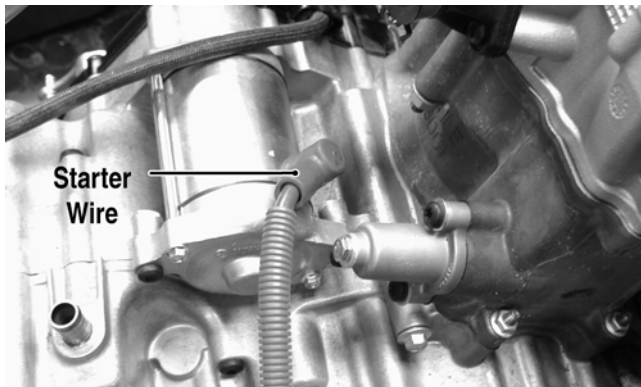

PR145A

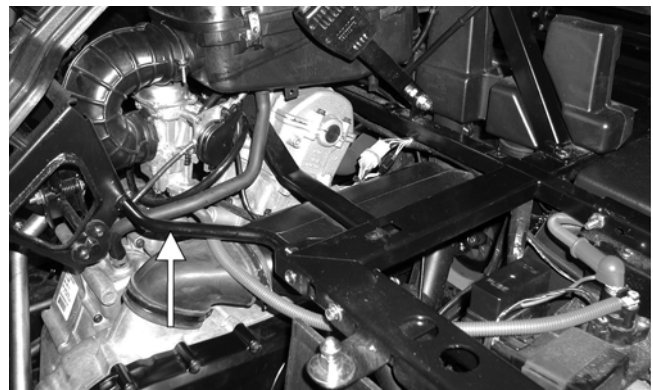

PR123A

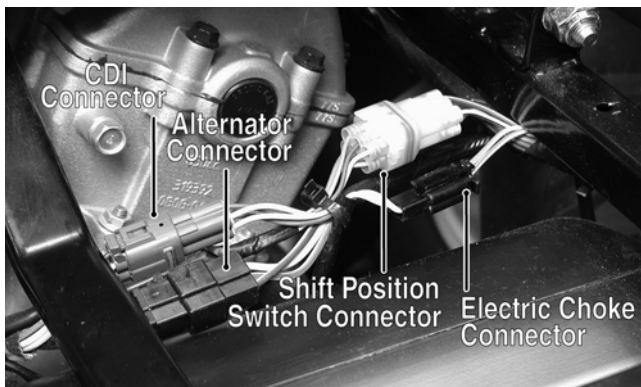

PR128A

8. Loosen the clamp securing the air intake boot to the carburetor and the clamp securing the air filter housing to the inlet housing boot; then remove the crankcase breather hose from the crankcase.



PR127A

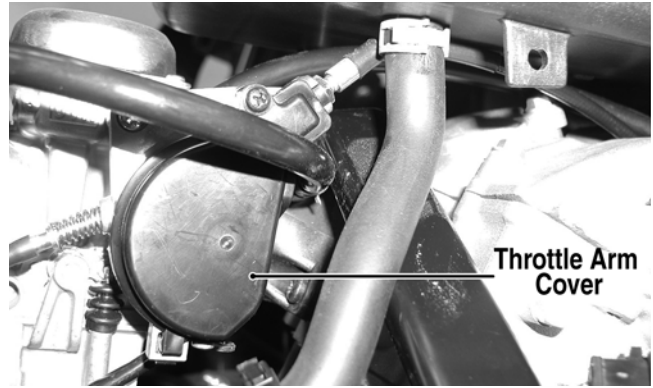

PR154A



PR118

9. Remove four self-tapping screws securing the air filter mounting bracket to the frame; then remove the air filter and mounting bracket as an assembly.



PR140A

10. Remove the throttle arm cover from the carburetor; then disconnect and remove the throttle cable and the carburetor.

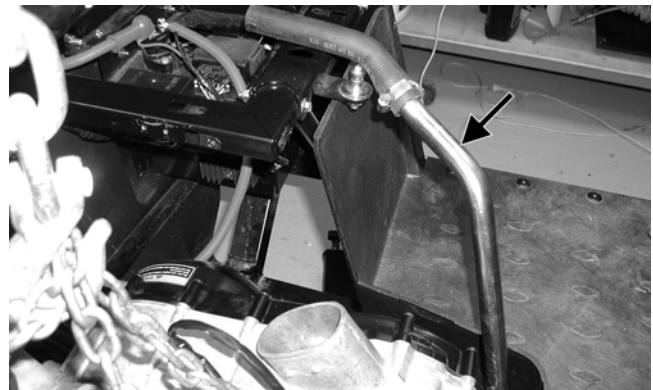

PR150A

11. Remove the coolant hoses from the water pump and thermostat housings; then position the upper coolant line to the left-side of the engine compartment.

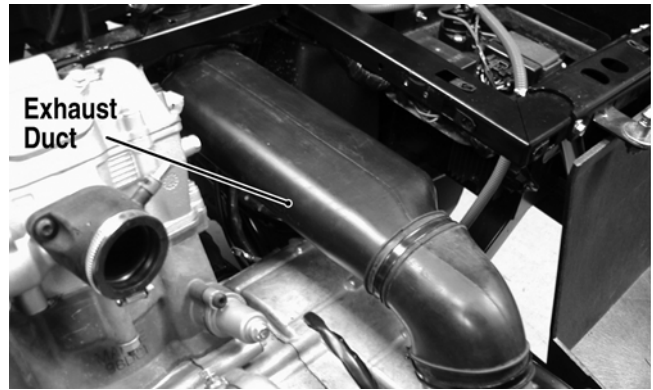

PR144B

12. Remove the exhaust duct from the V-belt housing; then remove the inlet boot connecting the inlet duct to the V-belt housing.



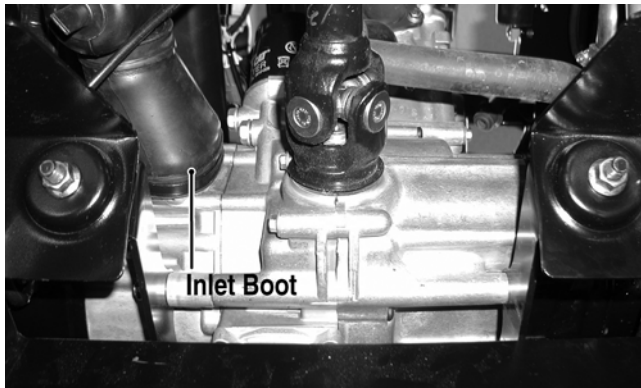

PR153B

13. Remove the muffler; then remove the exhaust pipe.

14. Set the parking brake; then from the underside of the vehicle, mark the flanges of the drive-line couplers for assembling and remove the cap screws (three on the front drive coupler and three on the rear drive coupler) securing the driveshafts to the drive couplers.

■ **NOTE:** Remove the front driveshaft first or the parking brake will not hold the coupler stationary and cap screw removing will be more difficult.



PR152A

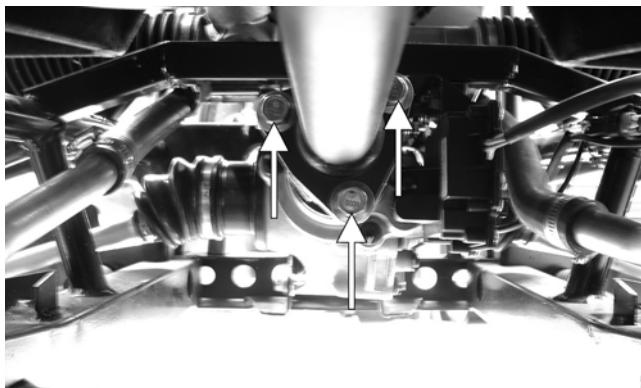

PR120A

15. Separate the drive coupler flanges; then remove the driveshafts from the splined slip-joints being careful not to damage the rubber boots. The front boot should be removed with the drive-shaft.

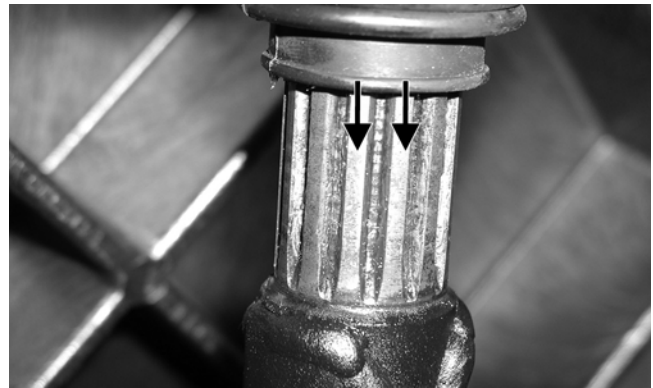

PR148A

16. Remove two flange nuts from the underside of the rear engine mounts.

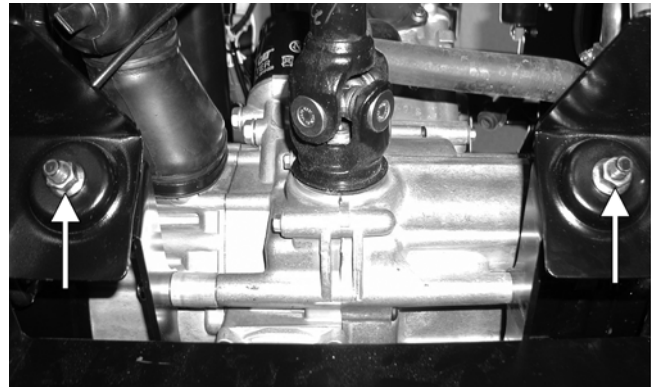

PR153A

17. Remove two flange nuts securing the engine mounting bracket to the front engine mounts.



PR147

18. Attach suitable lifting chains to the engine/transmission; then using an engine hoist, lift the assembly out of the engine compartment.

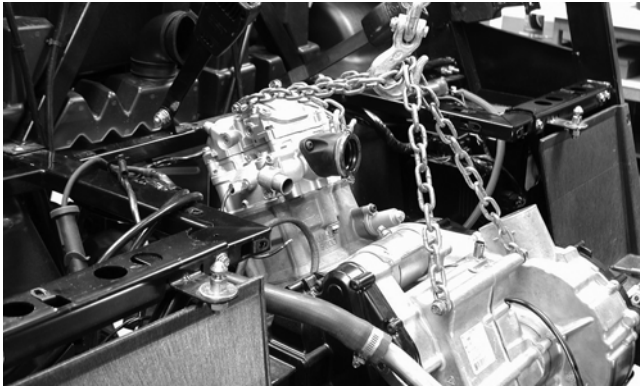

PR114

■ **NOTE:** The front engine mounting bracket should slide free of the engine mounts first; then the rear engine mounting bracket and two rear engine mounts will lift free of the frame.



PR146

## Top-Side Components

■ **NOTE:** For efficiency, it is preferable to remove and disassemble only those components which need to be addressed and to service only those components. The technician should use discretion and sound judgment.

### AT THIS POINT

To service any one specific component, only limited disassembly of components may be necessary. Note the AT THIS POINT information in each sub-section.

■ **NOTE:** The engine/transmission does not have to be removed from the frame for this procedure.

## Removing Top-Side Components

- A. Valve Cover**
- B. Cylinder Head**

■ **NOTE:** Remove the spark plug and timing inspection plug; then using the recoil starter, rotate the crankshaft to top-dead-center of the compression stroke.

1. Remove the two tappet covers.



CC001D

■ **NOTE:** Keep the mounting hardware with the covers for assembly purposes or thread them back into the head to keep them separated.

2. Remove the 12 cap screws securing the valve cover to the head; account for the four rubber washers on the top side cap screws. Remove the valve cover. Account for and note the orientation of the cylinder head plug. Note the location of two alignment pins.



CD205

3



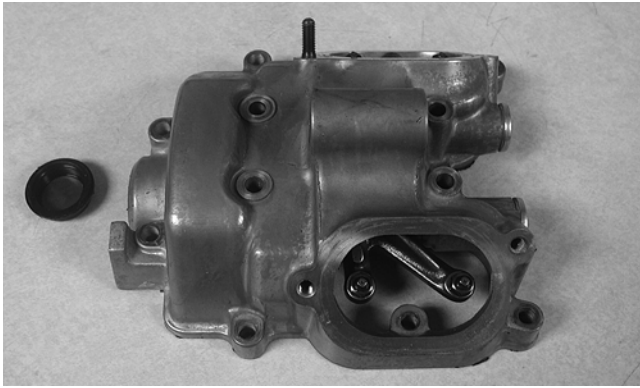

CD206

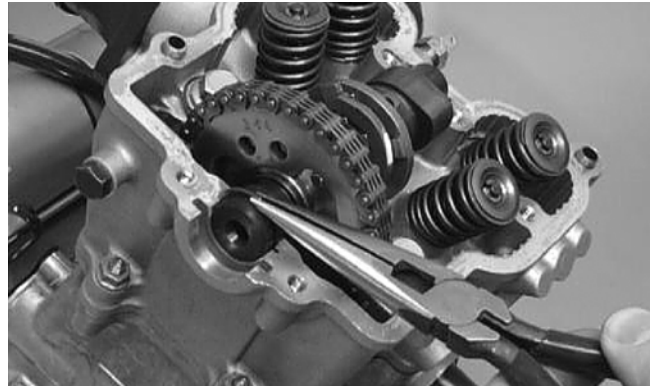

CC012D

5. Bend the washer tabs down and remove the two cap screws securing the sprocket to the camshaft; then drop the sprocket off the camshaft.

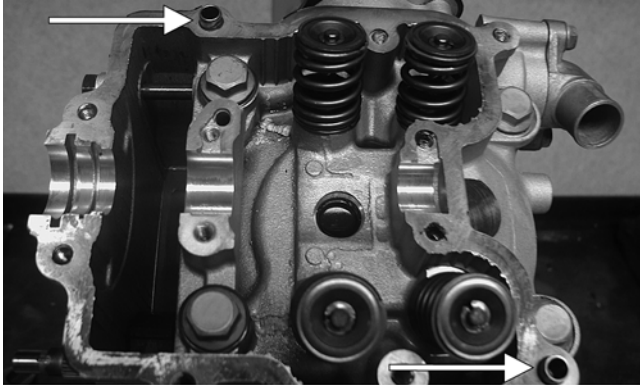

CD211A

3. Loosen the cap screw on the end of the tensioner; then remove the two Allen-head cap screws securing the tensioner adjuster assembly and remove the assembly. Account for a gasket.

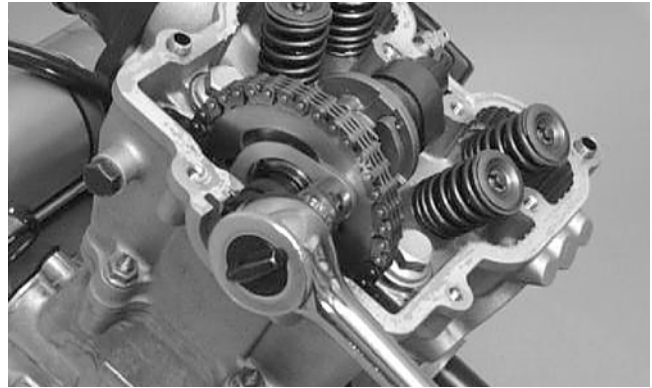

CC013D

6. Remove the cap screw securing the chain tensioner (account for a washer); then remove the tensioner.

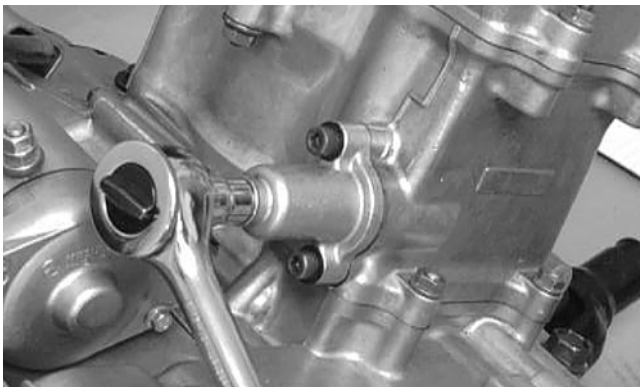

CC009D

4. Using an awl, rotate the C-ring in its groove until it is out of the cylinder head; then remove the C-ring.

■ **NOTE:** Care should be taken not to drop the C-ring down into the crankcase.



CC014D

7. While holding the chain, slide the sprocket and camshaft out of the cylinder head.

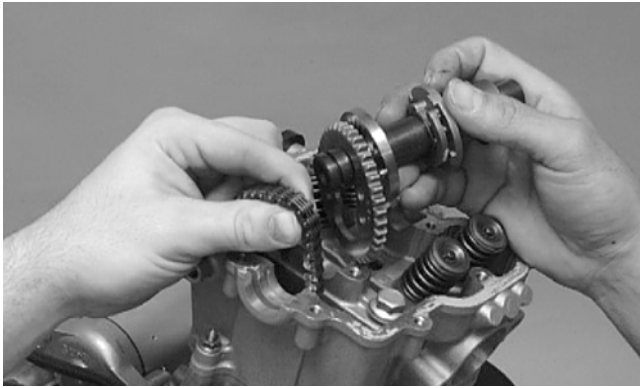

CC266D

■ **NOTE:** Loop the chain over the cylinder and secure it to keep it from falling into the crankcase.

8. Remove the five nuts securing the cylinder head to the cylinder; then remove the four cylinder head cap screws with copper washers (note location of the different-sized cap screws and nuts).

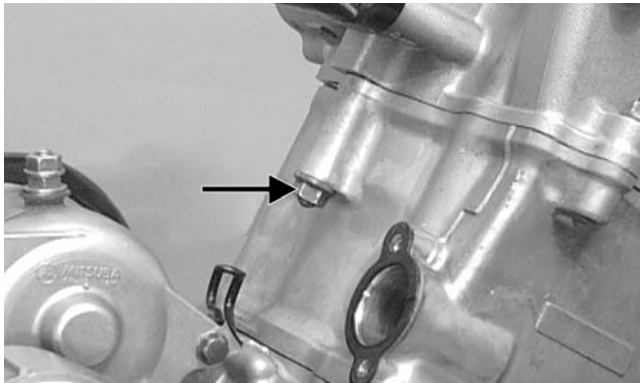

CC017D

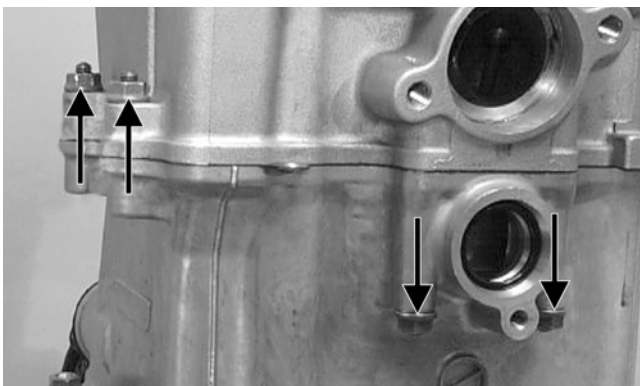

CC018D

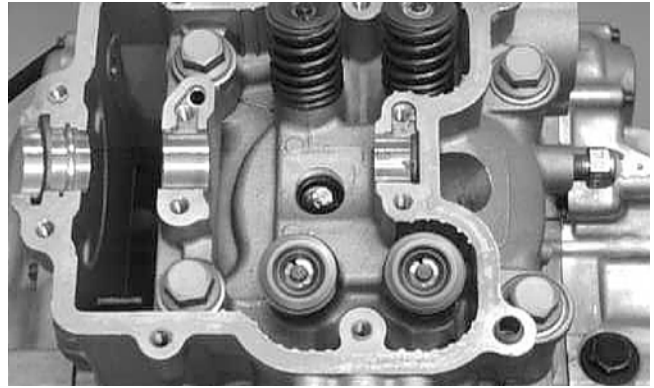

CC016D

9. Remove the cylinder head from the cylinder, remove the gasket, and account for two alignment pins; then remove the cam chain guide.

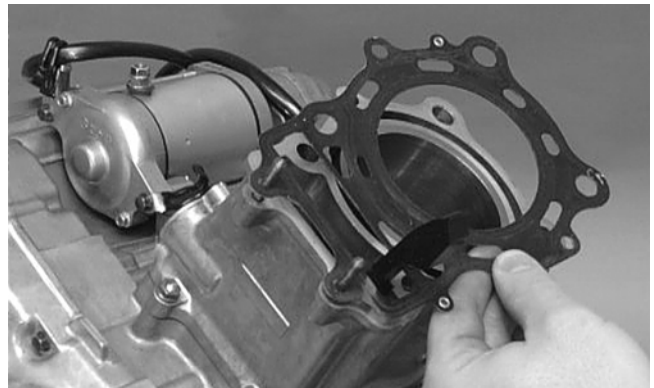

CC020D

**3**

**AT THIS POINT**  
To service valves and cylinder head, see Servicing Top-Side Components sub-section.

**AT THIS POINT**  
To inspect cam chain guide, see Servicing Top-Side Components sub-section.



CC022D



**C. Cylinder**  
**D. Piston**

■ **NOTE:** Steps 1-9 in the preceding sub-section must precede this procedure.

10. Loosen the clamp securing the coolant hose to the union; then detach the hose.
11. Remove the two nuts securing the cylinder to the crankcase.

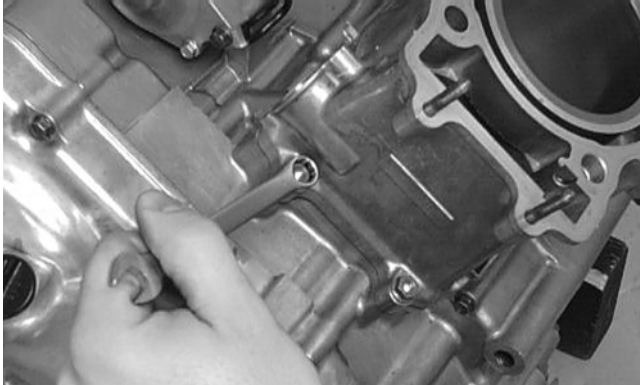

CC023D

12. Lift the cylinder off the crankcase taking care not to allow the piston to drop against the crankcase. Account for the gasket and two alignment pins.



CC024D



CC025D

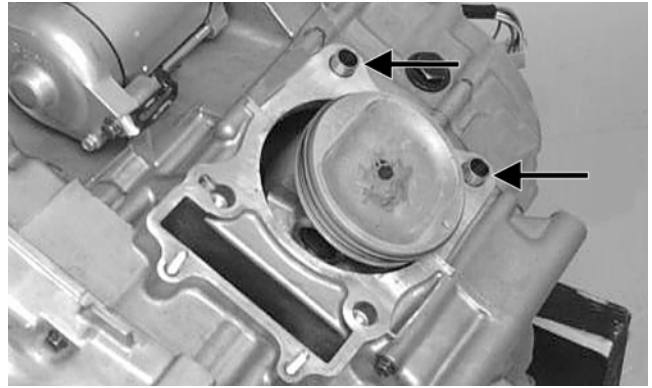

CC026D

**AT THIS POINT**

To service cylinder, see Servicing Top-Side Components sub-section.

**CAUTION**

When removing the cylinder, be sure to support the piston to prevent damage to the crankcase and piston.

13. Using an awl, remove one piston-pin circlip.

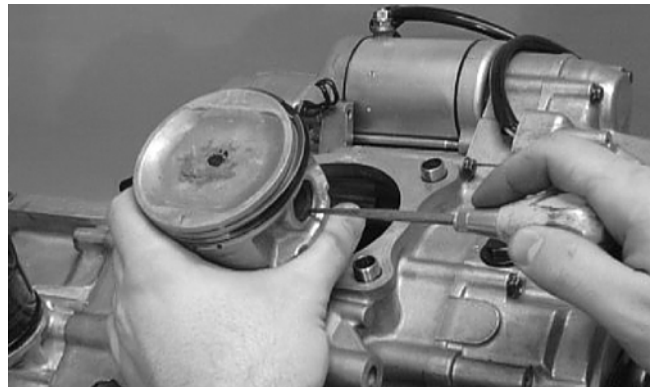

CC032D

14. Using the Piston Pin Puller (p/n 0644-328), remove the piston pin. Account for the opposite-side circlip. Remove the piston.

■ **NOTE:** It is advisable to remove the opposite-side circlip prior to using the puller.

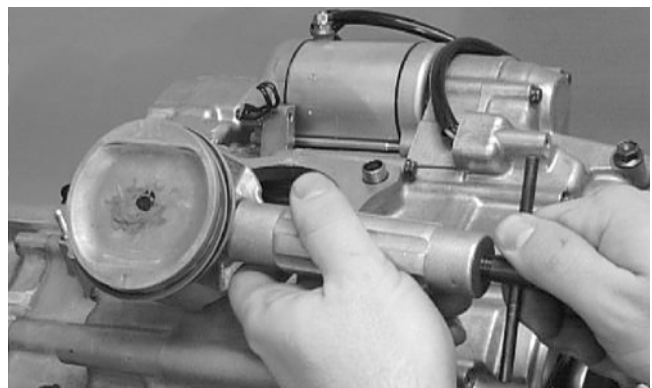

CC033D

■ **NOTE:** Support the connecting rod with rubber bands to avoid damaging the rod or install the Connecting Rod Holder (p/n 0444-006).

**⚠ CAUTION**

Do not allow the connecting rod to go down inside the crankcase. If the rod is down inside the crankcase and the crankshaft is rotated, severe damage will result.

■ **NOTE:** If the existing rings will not be replaced with new rings, note the location of each ring for proper installation. When replacing with new rings, replace as a complete set only. If the piston rings must be removed, remove them in this sequence.

- A. Starting with the top ring, slide one end of the ring out of the ring-groove.
- B. Remove each ring by working it toward the dome of the piston while rotating it out of the groove.

**🔧 AT THIS POINT**

To service piston, see Servicing Top-Side Components sub-section.

**🔧 AT THIS POINT**

To service center crankcase components only, proceed to Removing Left-Side Components.

## Right-Side Components

■ **NOTE:** For efficiency, it is preferable to remove and disassemble only those components which need to be addressed and to service only those components. The technician should use discretion and sound judgment.

**🔧 AT THIS POINT**

To service any one specific component, only limited disassembly of components may be necessary. Note the AT THIS POINT information in each sub-section.

■ **NOTE:** The engine/transmission does not have to be removed from the frame for this procedure.

## Removing Right-Side Components

- A. Water Pump**
- B. Right-Side Cover**
- C. Rotor/Flywheel**

1. Remove the four screws securing the outer magneto cover to the right-side cover; then remove the cover. Account for the gasket.
2. Remove the flange nut securing the spacer to the crankshaft; then remove the spacer. Account for the O-ring.



PR465

3. Using a cold chisel, scribe a mark showing the relative position of the shift arm to the shift arm shaft to aid in installing; then remove the shift arm.



PR429A

4. Remove the two cap screws securing the speed sensor housing; then remove the housing. Account for the gasket and two seal washers.

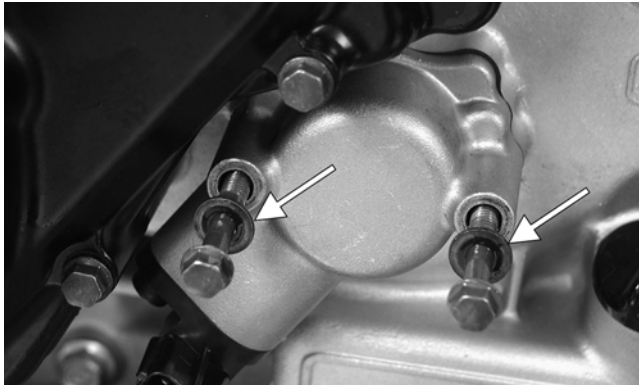

CD920A

5. Loosen the clamps securing the coolant hose to the water pump; then remove the crossover tube from the cylinder head. Account for an O-ring.

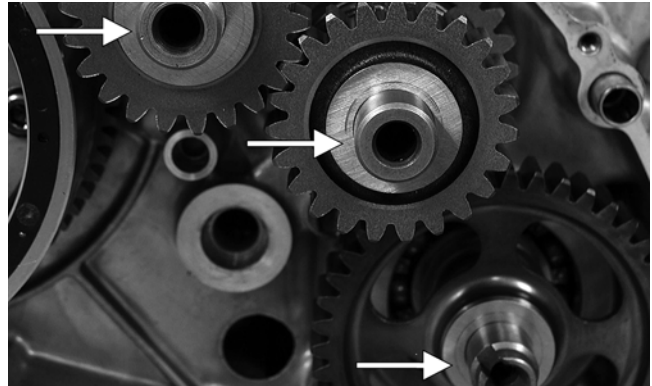

CF075A

9. Remove the nut securing the magneto rotor to the crankshaft; then install the magneto rotor puller adapter.

■ **NOTE:** The puller has left-hand threads.

10. Using Magneto Rotor Remover Set (p/n 0444-075), remove the rotor/flywheel assembly from the crankshaft. Account for the key; then remove the starter clutch gear assembly and washer.



CD214

6. Remove the two cap screws securing the water pump to the engine; then remove the water pump.

**AT THIS POINT**  
To service the water pump, see Section 4.

7. Remove the cap screws securing the right-side cover to the crankcase noting the location of the different-sized cap screws for installing purposes.

8. Using Side Case Puller (p/n 0644-262), remove the side cover. Account for a gasket and two alignment pins.

■ **NOTE:** Inspect the inside of the right-side cover for any shaft washers that may have come off with the cover. Make sure they are returned to their respective shafts and that the starter idler gear spacer is on the shaft or in the cover.

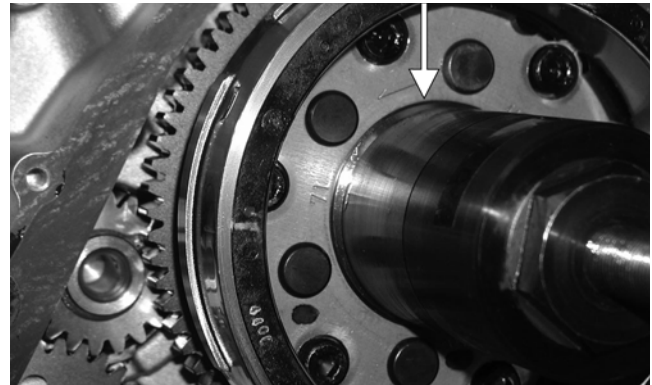

CD939A



CD940A

**AT THIS POINT**  
To service the magneto assembly, see Section 5.

11. Remove the two starter gears from the crankcase noting the direction of the beveled side of the gears for installing purposes; then remove the two starter gear shafts.



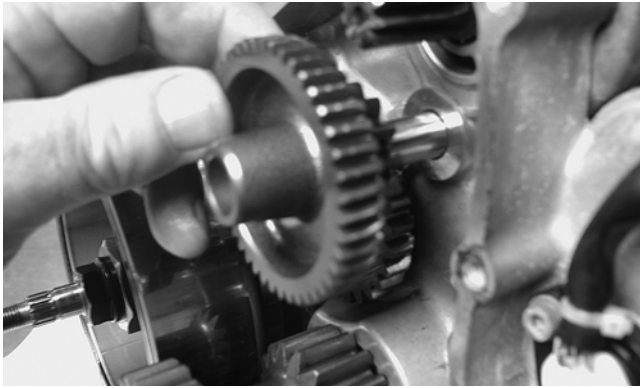

CD136



CD952A



CD140

12. Remove the snap ring securing the water pump drive gear; then remove the gear noting the direction of the sides of the gear for installing purposes. Account for the drive gear alignment pin.



CD944

13. Remove the snap ring securing the water pump driven gear; then remove the gear noting the direction of the sides of the gear for installing purposes. Account for the driven gear alignment pin.

■ **NOTE:** There is an oil passage beneath the driven gear/drive gear assembly. This passage should be plugged prior to removing the driven gear and drive gear. Failure to do so could result in the loss of an alignment pin into the crankcase.

14. Remove the shift shaft noting the timing marks for assembling purposes. Account for two washers.

**3**



F1302

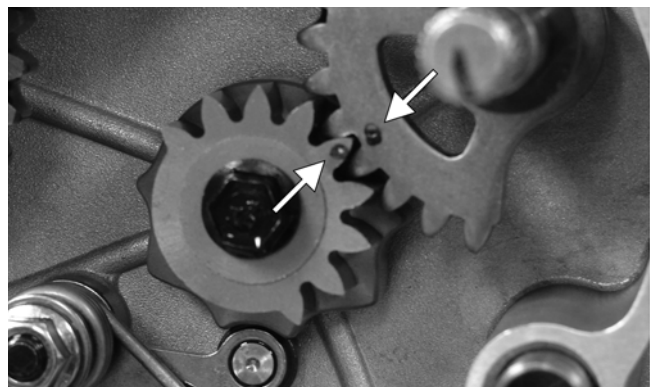

PR430A

15. Remove the gear shift cam plate; then remove the cam stopper and cam stopper spring. Account for two washers.



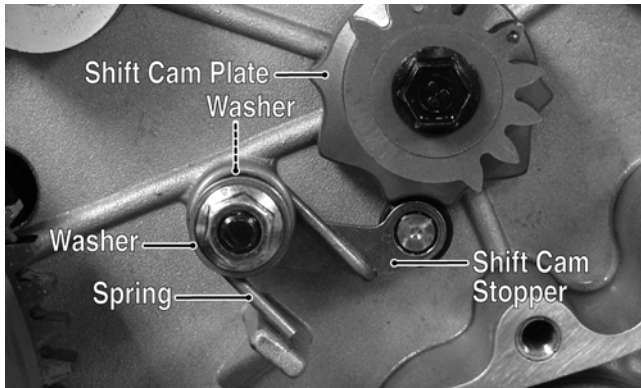

PR434A

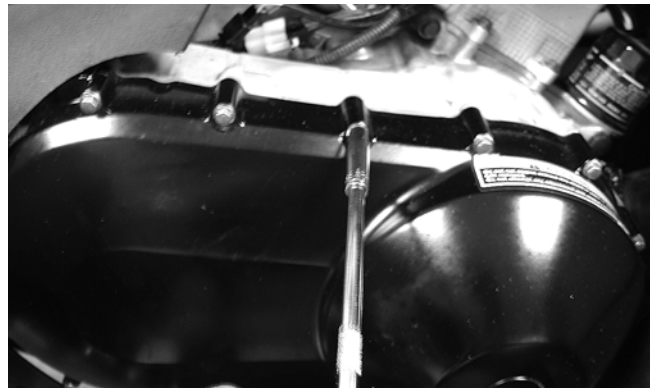

CD079

## Left-Side Components

■ **NOTE:** For efficiency, it is preferable to remove and disassemble only those components which need to be addressed and to service only those components. The technician should use discretion and sound judgment.

### AT THIS POINT

To service any one specific component, only limited disassembly of components may be necessary. Note the AT THIS POINT information in each sub-section.

■ **NOTE:** The engine/transmission does not have to be removed from the frame for this procedure.

## Removing Left-Side Components

- A. V-Belt Cover
- B. Driven Pulley
- C. Clutch Cover

1. Remove the cap screws securing the V-belt cover noting the location of the different-lengthed cap screws for installing purposes; then using a rubber mallet, gently tap on the cover tabs to loosen the cover.

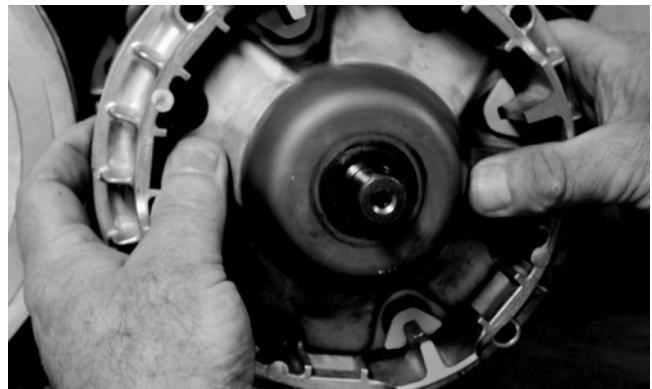

CD963

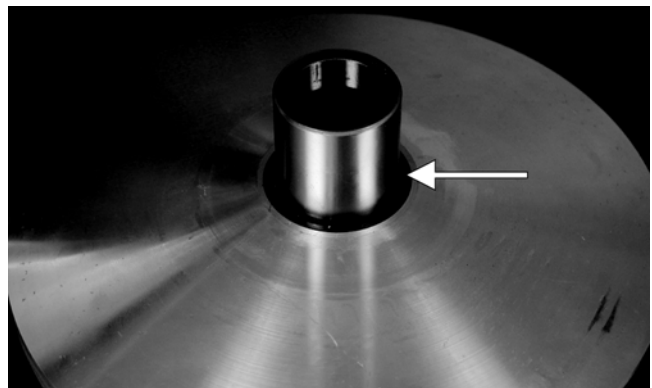

CD966A

3. Remove the V-belt.
4. Remove the nut securing the fixed driven assembly; then remove the assembly.

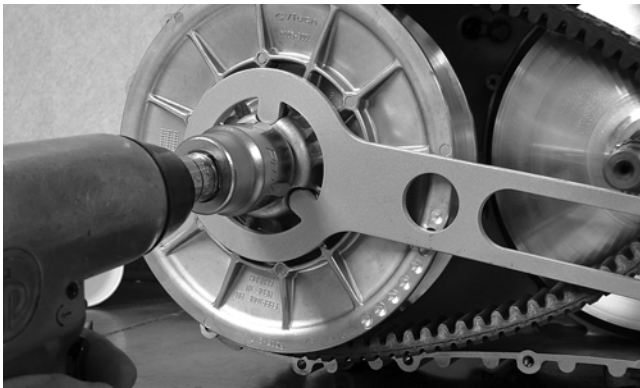

PR388

5. Remove the fixed drive face.
6. Using an impact driver, remove the cap screws securing the air intake plate; then remove the plate cushion.



PR393

7. Remove the cap screws securing the clutch cover. Note the location of the different-lengthed cap screws for installing purposes. Using a rubber mallet, carefully remove the cover. Account for two alignment pins.



CD973A

**CAUTION**  
Care must be taken when removing the cover so the cover gasket is not damaged.

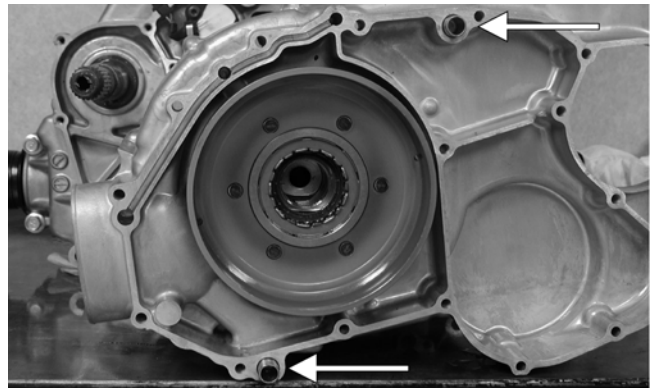

CD974A

■ **NOTE:** For steps 8-14, refer to illustration CC829B.

■ **NOTE:** To aid in installing, it is recommended that the assemblies are kept together and IN ORDER.

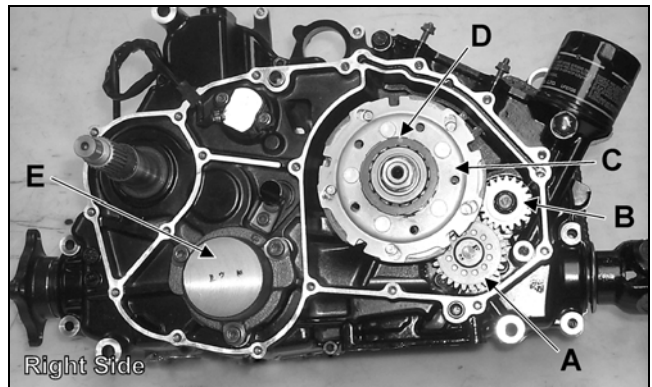

KEY	
A. Oil Pump Driven Gear	D. One-Way Clutch (Green Dot MUST Show)
B. Oil Pump Drive Gear	E. Final Drive Carrier Bearing Housing
C. Clutch Shoe Assembly	

CC829B

8. Remove the one-way clutch (D) from the clutch housing. Note the location of the green dot (or the word OUTSIDE) for installing purposes.
9. Using a hydraulic press, remove the clutch housing assembly from the clutch cover. Account for the left fixed drive spacer and an O-ring inside the fixed drive spacer.



CF085



CC596

■ **NOTE:** Account for and inspect the clutch housing seal.



FI279A

■ **NOTE:** The washer is also directional. The flat side of the washer must face toward the centrifugal clutch assembly when installing.

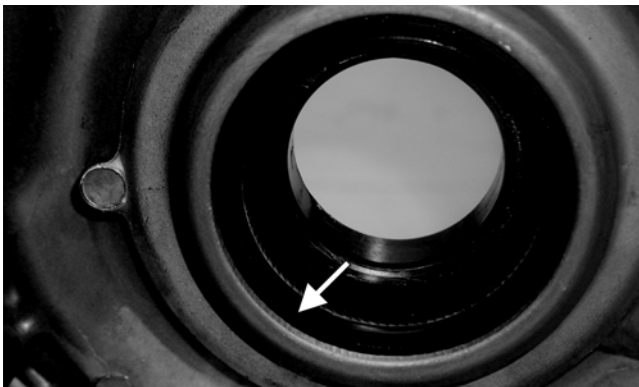

CF088A

10. Remove the two Allen-head screws securing the shift indicator sensor; then remove the sensor. Account for two neutral contact pins and two springs.

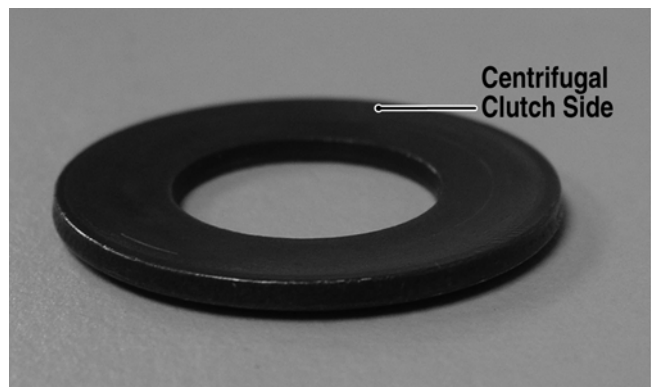

FI336A

12. Remove the cap screw securing the oil pump drive gear (B). Account for a cap screw, washer, pin, and spacer.

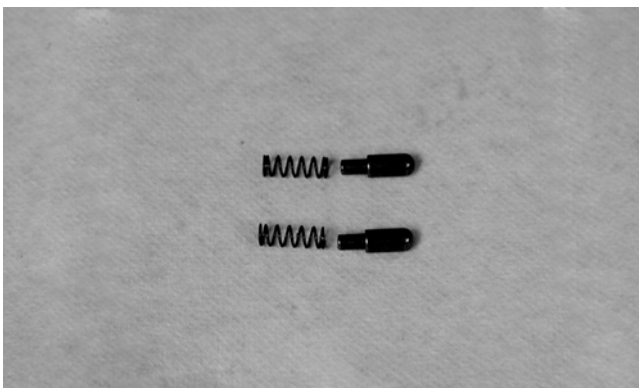

CD997

11. Remove the nut (left-hand threads) securing the clutch shoe assembly (C). Account for a washer.

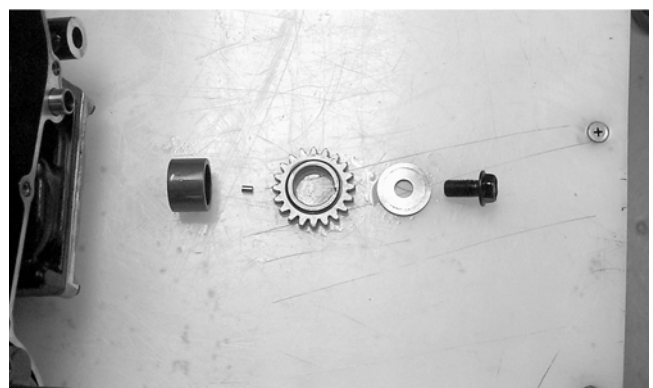

CC606



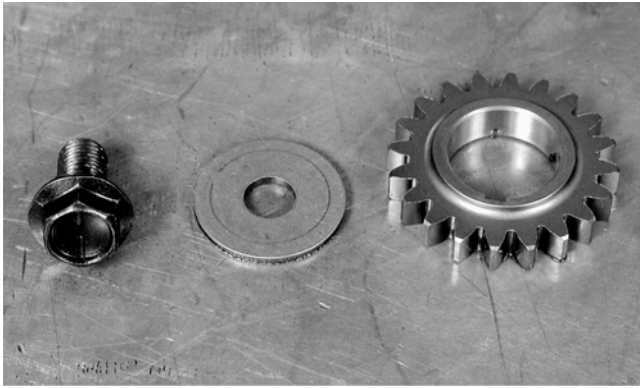

CD987



CD984



CD993

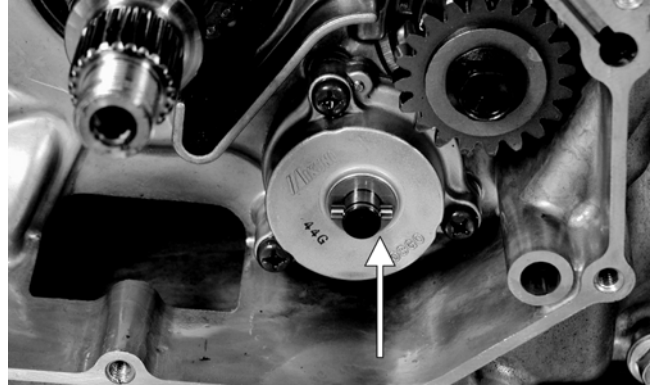

CD895A

13. Using an impact driver, remove the Allen-head screws securing the final drive carrier bearing housing (E); then remove the housing and account for two alignment pins.

15. Using an impact driver, remove the three Phillips-head screws securing the oil pump; then remove the pump.



CD999



CD988

14. Remove the snap ring securing the oil pump driven gear (A); then remove the gear noting the direction of the sides of the gear for installing purposes. Account for a pin and a washer.

3



## Center Crankcase Components

■ **NOTE:** This procedure cannot be done with the engine/transmission in the frame. Complete Removing procedures for Top-Side, Left-Side, and Right-Side must precede this procedure.

■ **NOTE:** For efficiency, it is preferable to remove and disassemble only those components which need to be addressed and to service only those components. The technician should use discretion and sound judgment.

## Separating Crankcase Halves

1. Remove the left-side cap screws securing the crankcase halves. Note the location of the different-lengthed cap screws.
2. Remove the right-side cap screws securing the crankcase halves. Note the location of the different-lengthed cap screws.
3. Using the Crankcase Separator/Crankshaft Remover (p/n 0444-009) and tapping lightly with a rubber mallet, separate the crankcase halves. Account for two alignment pins.

■ **NOTE:** To keep the shaft/gear assemblies intact for identification, tap the shafts toward the right-side crankcase half when separating the halves.

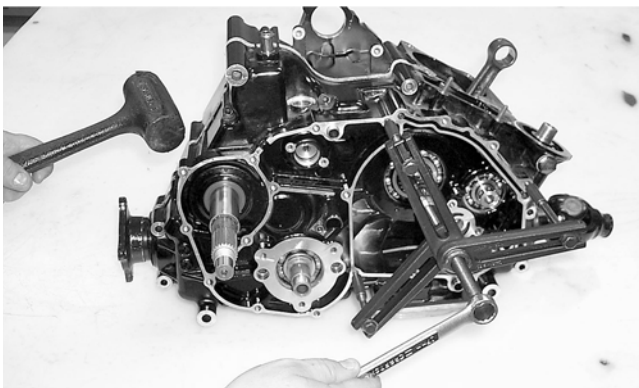

CC665

## Disassembling Crankcase Half

■ **NOTE:** For steps 1-7, refer to illustration CC821B.

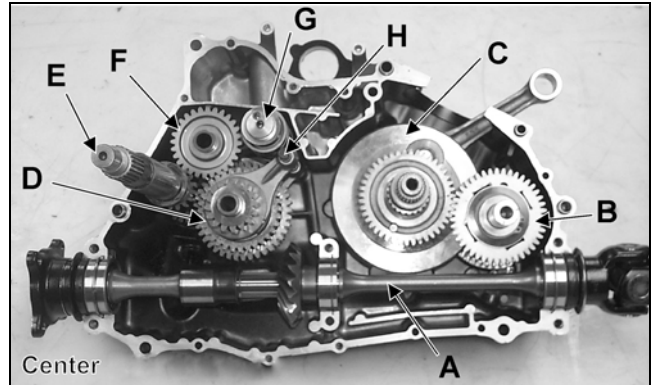

### KEY

- |                                    |                                |
|------------------------------------|--------------------------------|
| A. Secondary Driven Shaft Assembly | E. Driveshaft                  |
| B. Crank Balancer Gear             | F. Reverse Idler Gear Assembly |
| C. Crankshaft Gear                 | G. Gear Shift Shaft            |
| D. Countershaft Assembly           | H. Shift Shaft with 2 Forks    |

CC821B

■ **NOTE:** To aid in installing, it is recommended that the assemblies are kept together and **IN ORDER**.

1. Remove the secondary driven shaft assembly (A) noting the location of the bearing locating pins. Account for the bearing C-ring.

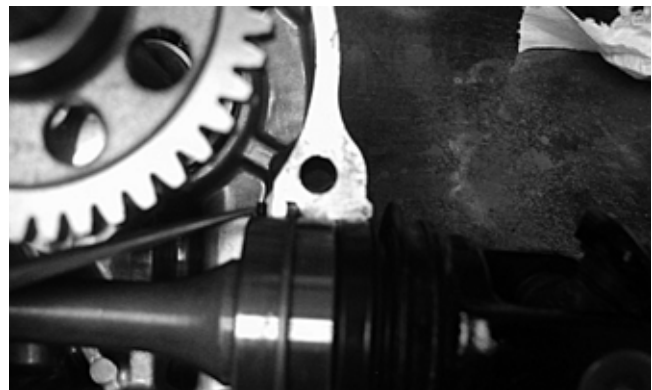

CD267

2. Remove the reverse idler gear assembly (F). Account for all washers, shaft, bushing, and the gear.

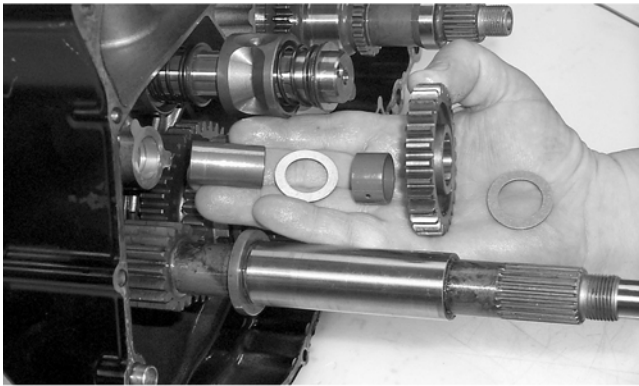

CC668

3. Remove the shift shaft (H); then remove the two forks taking note of the direction of the tabs on the forks for assembling purposes.
4. Remove the gear shift shaft (G) noting the location of the two holes on the end of the shaft. Account for two washers.



PR380A

5. Remove the countershaft assembly (D). Account for a washer on each end of the countershaft.

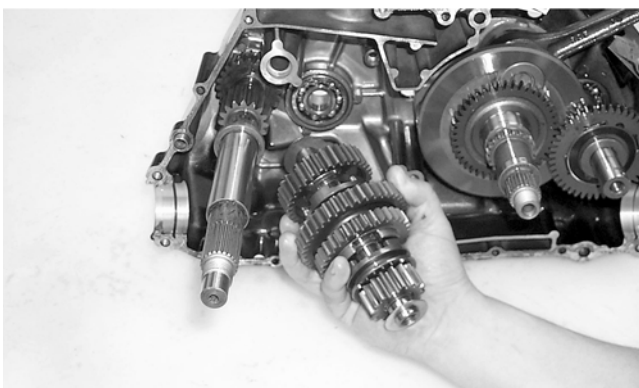

CC674

■ **NOTE:** Do not disassemble the countershaft assembly unless necessary. If necessary, see Servicing Center Crankcase Components sub-section.

6. Using a rubber mallet, tap on the crankcase to remove the driveshaft (E).

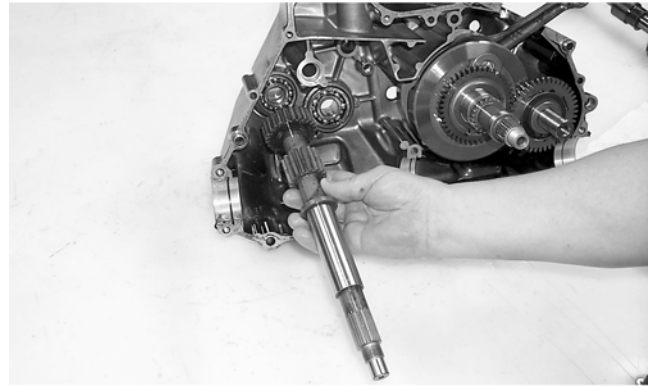

CC675

7. Note the timing marks on the crank balancer gear (B) and crankshaft gear (C) for assembling purposes; then slide the crank balancer gear off the crank balancer. Account for the key in the keyway.



CD826

8. Remove the crank balancer.

■ **NOTE:** There is a flat spot on the crank balancer bearing flange to allow clearance past the crankshaft.

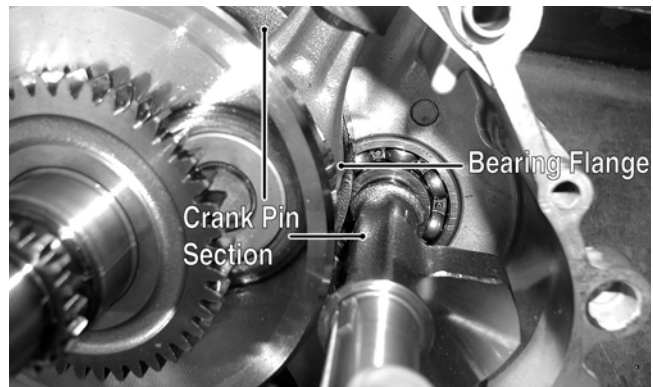

CD832B

9. Remove the snap ring securing the water pump driven gear shaft.
10. Using a hydraulic press, remove the crankshaft assembly.

■ **NOTE:** Use a protective end cap to prevent damage to the crankshaft threads.

3

11. Remove the cap screws securing the oil strainer cap; then remove the cap. Account for the cap O-ring.



PR407

12. Remove the two cap screws securing the oil strainer; then remove the strainer.

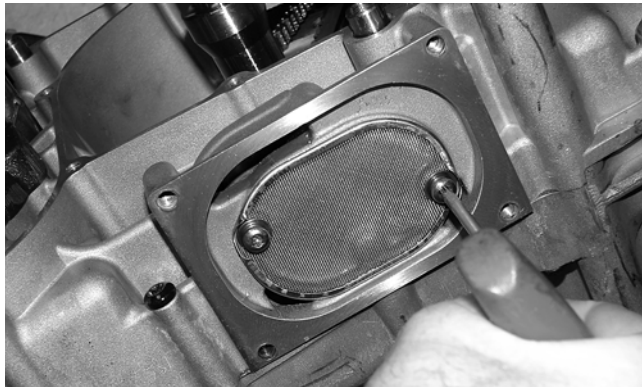

PR406

**CAUTION**

Do not remove the remaining output shaft assembly unless absolutely necessary. If the shaft is removed, the shaft nut must be replaced with a new one and the shaft must be re-shimmed.

13. To remove the assembly, remove the nut securing the secondary drive gear and secondary driven gear; then from the inside of the crankcase using a rubber mallet, remove the output shaft assembly. Account for the output shaft, two gears, a shim, a washer, and the nut.



CC686

## Table of Contents (Servicing Components)

■ **NOTE:** Critical engine/transmission specifications are located at the beginning of this section.

Servicing Top-Side Components .....	3-20
Valve Assembly .....	3-20
Piston Assembly .....	3-23
Cylinder/Cylinder Head Assembly.....	3-25
Servicing Left-Side Components .....	3-28
Inspecting Centrifugal Clutch Shoe .....	3-28
Inspecting Clutch Housing .....	3-29
Inspecting Primary One-Way Drive .....	3-29
Inspecting Oil Pump .....	3-29
Driven Pulley Assembly .....	3-29
Servicing Center Crankcase Components .....	3-33
Secondary Gears .....	3-33
Crankshaft Assembly .....	3-34
Countershaft .....	3-36

## Servicing Top-Side Components

■ **NOTE:** Whenever a part is worn excessively, cracked, or damaged in any way, replacement is necessary.

### VALVE ASSEMBLY

When servicing valve assembly, inspect valve seats, valve stems, valve faces, and valve stem ends for pits, burn marks, or other signs of abnormal wear.

■ **NOTE:** Whenever a valve is out of tolerance, it must be replaced.



## Cleaning/Inspecting Valve Cover

■ **NOTE:** If the valve cover cannot be trued, the cylinder head assembly must be replaced.

1. Wash the valve cover in parts-cleaning solvent.
2. Place the valve cover on the Surface Plate (p/n 0644-016) covered with #400 grit wet-or-dry sandpaper. Using light pressure, move the valve cover in a figure eight motion. Inspect the sealing surface for any indication of high spots. A high spot can be noted by a bright metallic finish. Correct any high spots before assembly by continuing to move the valve cover in a figure eight motion until a uniform bright metallic finish is attained.

### ⚠ CAUTION

Do not remove an excessive amount of the sealing surface or damage to the camshaft will result. Always check camshaft clearance when resurfacing the valve cover.

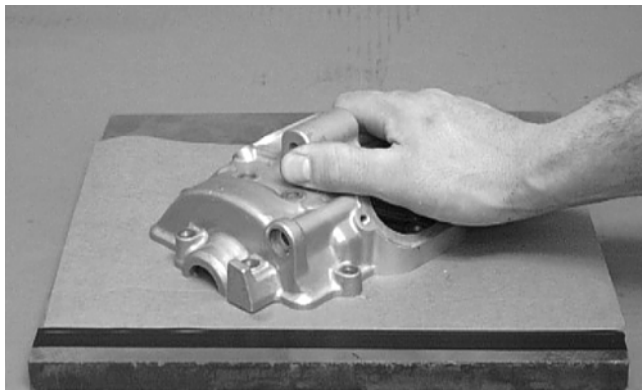

CC130D

### ⚠ CAUTION

Water or parts-cleaning solvent must be used in conjunction with the wet-or-dry sandpaper or damage to the sealing surface may result.

## Removing Valves

■ **NOTE:** Keep all valves and valve components as a set. Note the original location of each valve set for use during installation. Return each valve set to its original location during installation.

1. Using a valve spring compressor, compress the valve springs and remove the valve cotters. Account for an upper spring retainer.

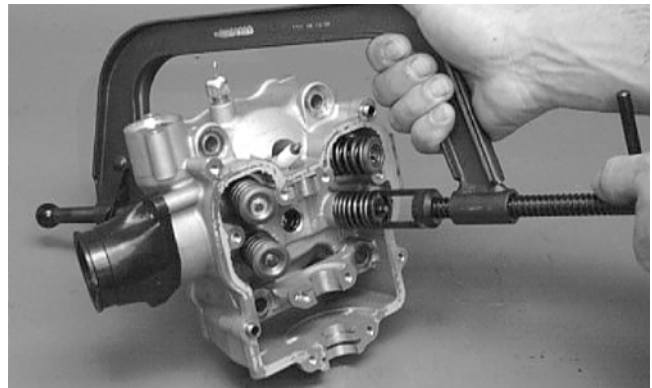

CC132D

2. Remove the valve seal and the lower remaining spring seat. Discard the valve seal.

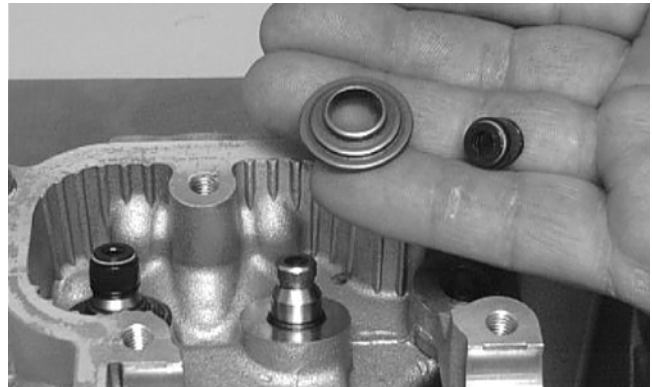

CC136D

■ **NOTE:** The valve seals must be replaced.

3. Remove the valve springs; then invert the cylinder head and remove the valves.

## Measuring Valve Stem Runout

1. Support each valve stem end with the V Blocks (p/n 0644-022); then check the valve stem runout using a dial indicator.

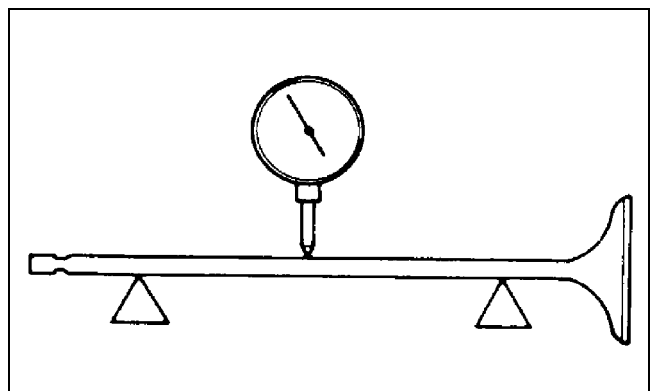

ATV-1082

2. Maximum runout must not exceed specifications.



### Measuring Valve Stem Outside Diameter

1. Using a micrometer, measure the valve stem outside diameter.
2. Acceptable diameter range (intake valve) must be within specifications.
3. Acceptable diameter range (exhaust valve) must be within specifications.

### Measuring Valve Face/Seat Width

1. Using a micrometer, measure the width of the valve face.

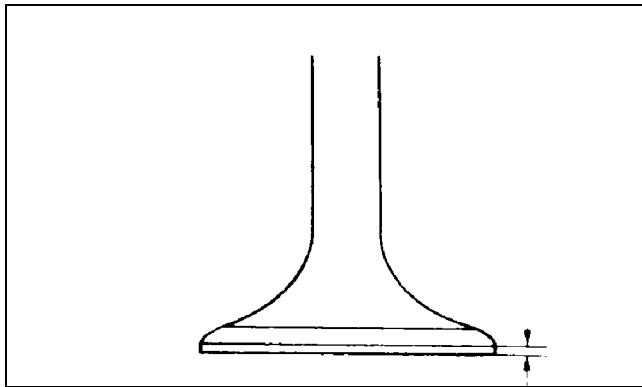

ATV-1004

2. Acceptable width range must be within specifications.

### Measuring Valve Face Radial Runout

1. Mount a dial indicator on the surface plate; then place the valve stem on a set of V blocks.
2. Position the dial indicator contact point on the outside edge of the valve face; then zero the indicator.

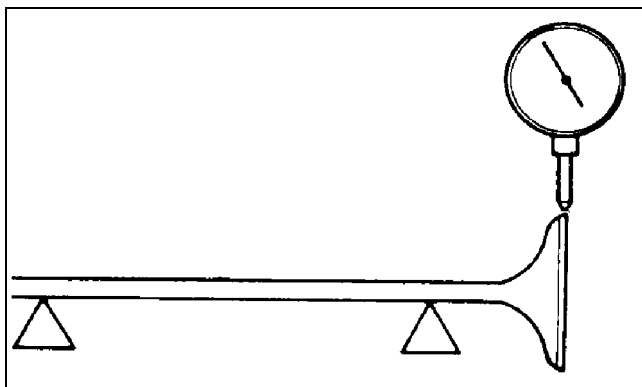

ATV1082A

3. Rotate the valve in the V blocks.
4. Maximum runout must not exceed specifications.

### Measuring Valve Guide/Valve Stem Deflection (Wobble Method)

1. Mount a dial indicator and base on the surface plate; then place the cylinder head on the surface plate.
2. Install the valve into the cylinder head; then position the dial indicator contact point against the outside edge of the valve face. Zero the indicator.

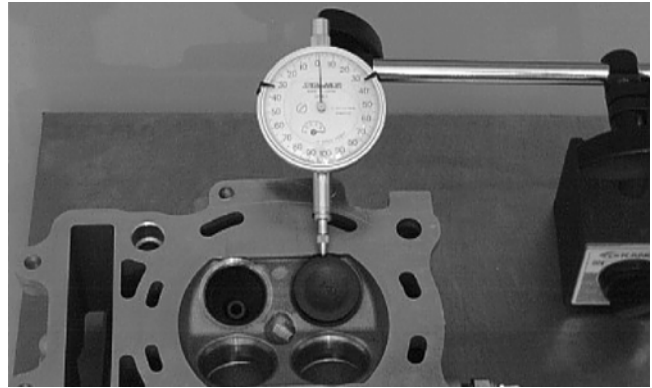

CC131D

3. Push the valve from side to side; then from top to bottom.
4. Maximum "wobble" deflection must not exceed specifications.

### Measuring Valve Guide (Inside Diameter)

1. Insert a snap gauge 1/2 way down into each valve guide bore; then remove the gauge and measure it with a micrometer.
2. Acceptable inside diameter range must be within specifications.
3. If a valve guide is out of tolerance, it must be replaced.

### Servicing Valves/Valve Guides/Valve Seats

If valves, valve guides, or valve seats require servicing or replacement, Arctic Cat recommends that the components be taken to a qualified machine shop for servicing.

#### ⚠ CAUTION

If valves are discolored or pitted or if the seating surface is worn, the valve must be replaced. Do not attempt to grind the valves or severe engine damage may occur.

### Measuring Rocker Arm (Inside Diameter)

1. Using a dial calipers, measure the inside diameter of the rocker arm.
2. Acceptable inside diameter range must be within specifications.

### Measuring Rocker Arm Shaft (Outside Diameter)

1. Using a micrometer, measure the outside diameter of the rocker arm shaft.
2. Acceptable outside diameter range must be within specifications.

### Installing Valves

1. Apply grease to the inside surface of the valve seals; then place a lower spring seat and valve guide seal over each valve guide.

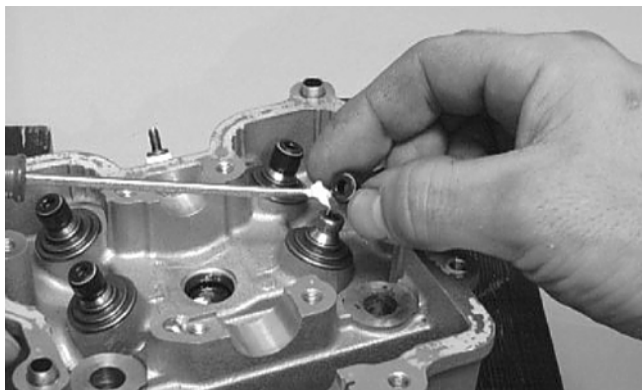

CC144D

2. Insert each valve into its original location.
3. Install the valve springs with the painted end of the spring facing away from the cylinder head.

■ **NOTE:** If the paint is not visible, install the ends of the springs with the closest wound coils toward the head.

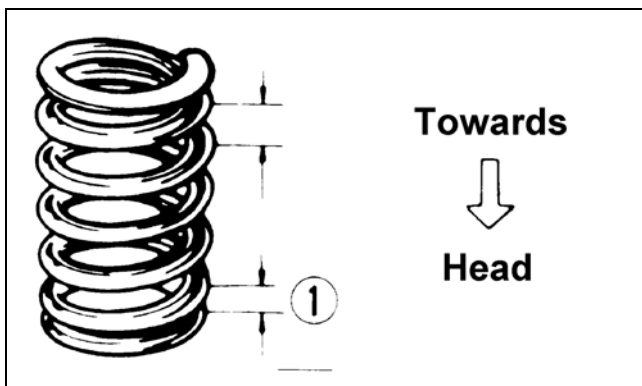

ATV-1011A

4. Place a spring retainer over the valve springs; then using the valve spring compressor, compress the valve springs and install the valve cotter pins.

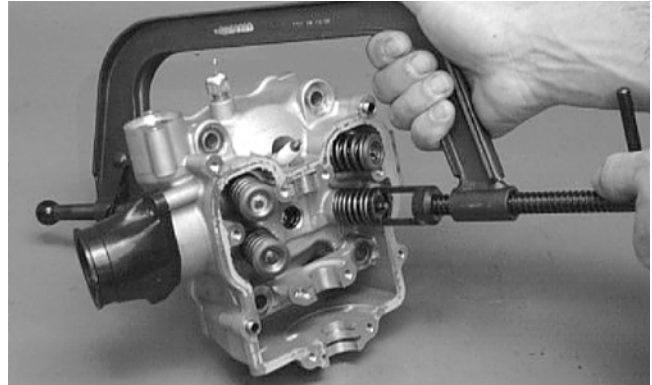

CC132D

### PISTON ASSEMBLY

■ **NOTE:** Whenever a piston, rings, or pin are out of tolerance, they must be replaced.

**3**

#### Cleaning/Inspecting Piston

1. Using a non-metallic carbon removal tool, remove any carbon buildup from the dome of the piston.
2. Inspect the piston for cracks in the piston pin, dome, and skirt areas.
3. Inspect the piston for seizure marks or scuffing. Repair with #400 grit wet-or-dry sandpaper and water or honing oil.

■ **NOTE:** If scuffing or seizure marks are too deep to correct with the sandpaper, replace the piston.

4. Inspect the perimeter of each piston for signs of excessive "blowby." Excessive "blowby" indicates worn piston rings or an out-of-round cylinder.

#### Removing Piston Rings

1. Starting with the top ring, slide one end of the ring out of the ring-groove.



CC400D

2. Remove each ring by working it toward the dome of the piston while rotating it out of the groove.

■ **NOTE:** If the existing rings will not be replaced with new ones, note the location of each ring for proper installation. When installing new rings, install as a complete set only.

### Cleaning/Inspecting Piston Rings

1. Take an old piston ring and snap it into two pieces; then grind the end of the old ring to a 45° angle and to a sharp edge.
2. Using the sharpened ring as a tool, clean carbon from the ring-grooves. Be sure to position the ring with its tapered side up.

 **CAUTION**

Improper cleaning of the ring-grooves by the use of the wrong type of ring-groove cleaner will result in severe damage to the piston.

### Measuring Piston-Ring End Gap (Installed)

1. Place each compression ring in the wear portion of the cylinder. Use the piston to position each ring squarely in the cylinder.
2. Using a feeler gauge, measure each piston-ring end gap. Acceptable ring end gap must be within specifications.

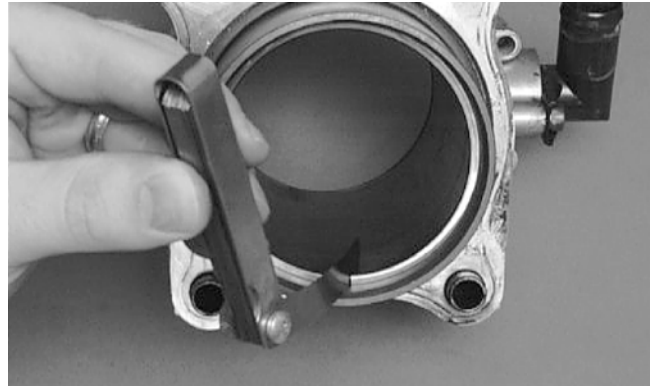

CC280D

### Measuring Piston Pin (Outside Diameter) and Piston-Pin Bore

1. Measure the piston pin outside diameter at each end and in the center. If measurement is not within specifications, the piston pin must be replaced.

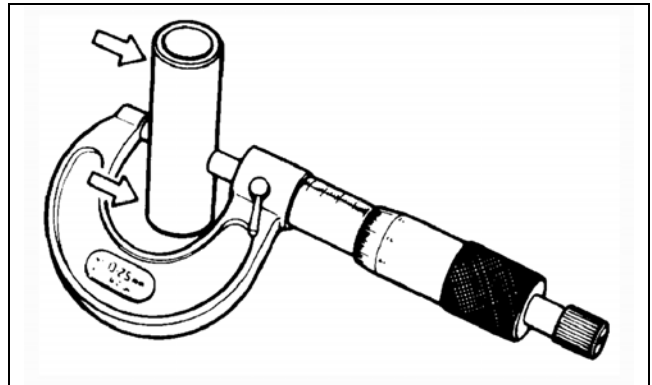

ATV-1070

2. Insert an inside dial indicator into the piston-pin bore. The diameter must not exceed specifications. Take two measurements to ensure accuracy.

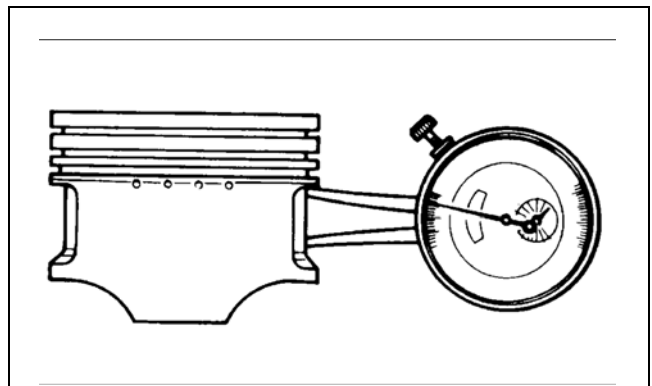

ATV-1069



## Measuring Piston Skirt/ Cylinder Clearance

1. Measure the cylinder front to back in six places.

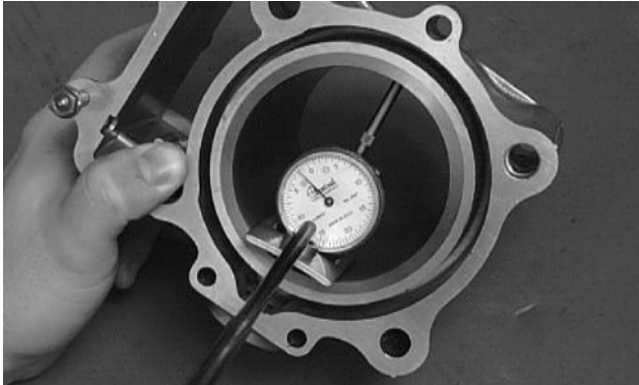

CC127D

2. Measure the corresponding piston diameter at a point 15 mm (0.6 in.) above the piston skirt at a right angle to the piston-pin bore. Subtract this measurement from the measurement in step 1. The difference (clearance) must be within specifications.

## Installing Piston Rings

1. Install ring expander (4) in the bottom groove of the piston; then install the thin oil rings (3) over the expander making sure the expander ends do not overlap. Stagger the end gaps of the upper and lower thin oil rings according to the illustration.

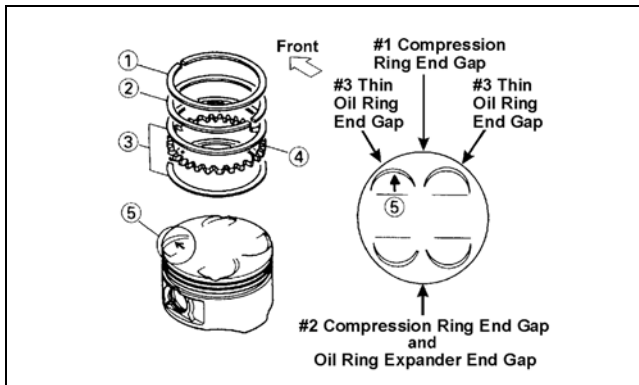

ATV-1085B

■ **NOTE:** Note the direction of the exhaust side of the piston (5) for correct ring end gap orientation.

2. The ring with the orientation mark (M TOP) should be installed in the second (middle) groove and the ring with the orientation mark (M) should be installed in the first (top) groove.

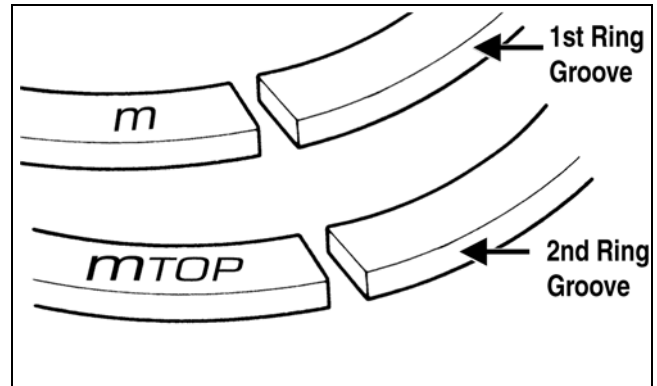

ATV-1024A

### ⚠ CAUTION

Incorrect installation of the piston rings will result in engine damage.

## CYLINDER/CYLINDER HEAD ASSEMBLY

■ **NOTE:** If the cylinder/cylinder head assembly cannot be trued, they must be replaced.

3

## Cleaning/Inspecting Cylinder Head

### ⚠ CAUTION

The cylinder head studs must be removed for this procedure.

1. Using a non-metallic carbon removal tool, remove any carbon buildup from the combustion chamber being careful not to nick, scrape, or damage the combustion chamber or the sealing surface.
2. Inspect the spark plug hole for any damaged threads. Repair damaged threads using a "heli-coil" insert.
3. Place the cylinder head on the surface plate covered with #400 grit wet-or-dry sandpaper. Using light pressure, move the cylinder head in a figure eight motion. Inspect the sealing surface for any indication of high spots. A high spot can be noted by a bright metallic finish. Correct any high spots before continuing by continuing to move the cylinder head in a figure eight motion until a uniform bright metallic finish is attained.

### ⚠ CAUTION

Water or parts-cleaning solvent must be used in conjunction with the wet-or-dry sandpaper or damage to the sealing surface may result.

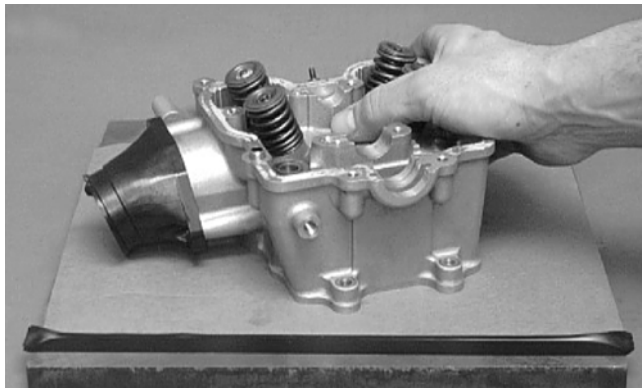

CC128D

### Measuring Cylinder Head Distortion

1. Remove any carbon buildup in the combustion chamber.
2. Lay a straightedge across the cylinder head; then using a feeler gauge, check the distortion factor between the head and the straightedge.
3. Maximum distortion must not exceed specifications.

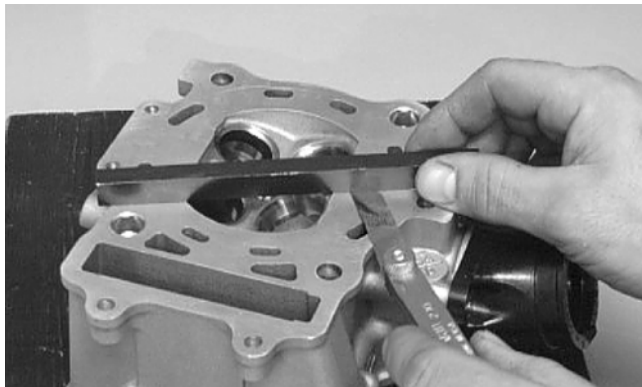

CC141D

### Cleaning/Inspecting Cylinder

1. Wash the cylinder in parts-cleaning solvent.
2. Inspect the cylinder for pitting, scoring, scuffing, warpage, and corrosion. If marks are found, repair the surface using a cylinder hone (see Honing Cylinder in this sub-section).
3. Place the cylinder on the surface plate covered with #400 grit wet-or-dry sandpaper. Using light pressure, move the cylinder in a figure eight motion. Inspect the sealing surface for any indication of high spots. A high spot can be noted by a bright metallic finish. Correct any high spots before assembly by continuing to move the cylinder in a figure eight motion until a uniform bright metallic finish is attained.

**⚠ CAUTION**

Water or parts-cleaning solvent must be used in conjunction with the wet-or-dry sandpaper or damage to the sealing surface may result.

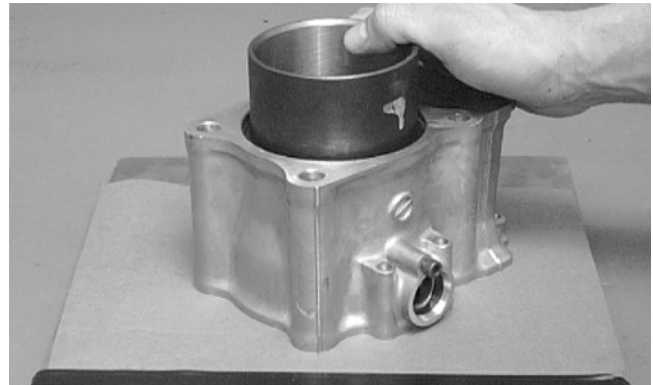

CC129D

### Inspecting Cam Chain Guide

1. Inspect cam chain guide for cuts, tears, breaks, or chips.
2. If the chain guide is damaged, it must be replaced.

### Honing Cylinder

1. Using a slide gauge and a dial indicator or a snap gauge, measure the cylinder bore diameter in three locations from top to bottom and again from top to bottom at 90° from the first measurements for a total of six measurements. The trueness (out-of-roundness) is the difference between the highest and lowest reading. Maximum trueness (out-of-roundness) must not exceed specifications.

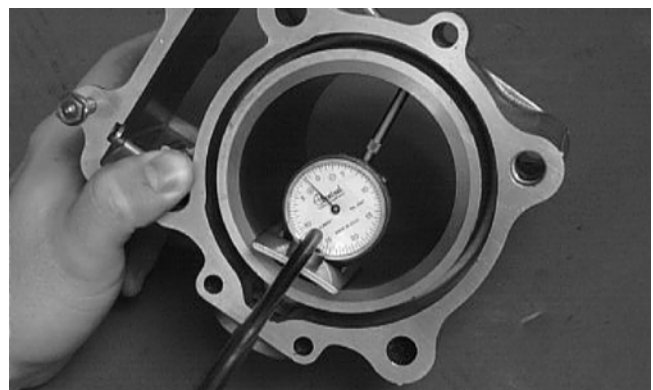

CC127D

2. Wash the cylinder in parts-cleaning solvent.
3. Inspect the cylinder for pitting, scoring, scuffing, and corrosion. If marks are found, repair the surface using a ball hone.

■ **NOTE:** To produce the proper 60° cross-hatch pattern, use a low RPM drill (600 RPM) at the rate of 30 strokes per minute. If honing oil is not available, use a lightweight petroleum-based oil. Thoroughly clean cylinder after honing using soap and hot water. Dry with compressed air; then immediately apply oil to the cylinder bore. If the bore is severely damaged or gouged, replace the cylinder.



CC390D

4. If any measurement exceeds the limit, replace the cylinder and piston.

### Measuring Camshaft Runout

■ **NOTE:** If the camshaft is out of tolerance, it must be replaced.

1. Place the camshaft on a set of V blocks; then position the dial indicator contact point against the shaft and zero the indicator.

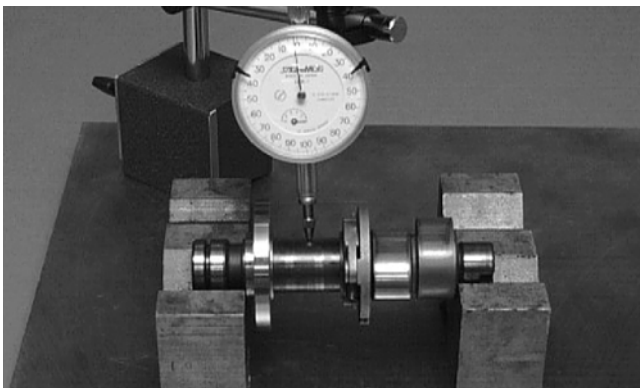

CC283D

2. Rotate the camshaft and note runout; maximum tolerance must not exceed specifications.

### Measuring Camshaft Lobe Height

1. Using a calipers, measure each cam lobe height.

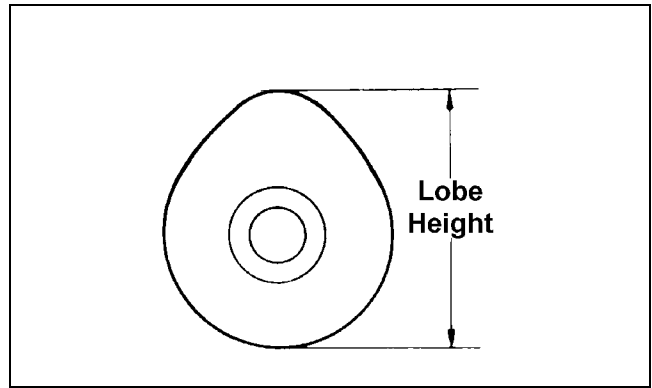

ATV1013A

2. The lobe heights must not exceed minimum specifications.

### Inspecting Camshaft Bearing Journal

1. Inspect the bearing journal for scoring, seizure marks, or pitting.
2. If excessive scoring, seizure marks, or pitting is found, the cylinder head assembly must be replaced.

**3**

### Measuring Camshaft to Cylinder Head Clearance

1. Remove the adjuster screws and jam nuts.

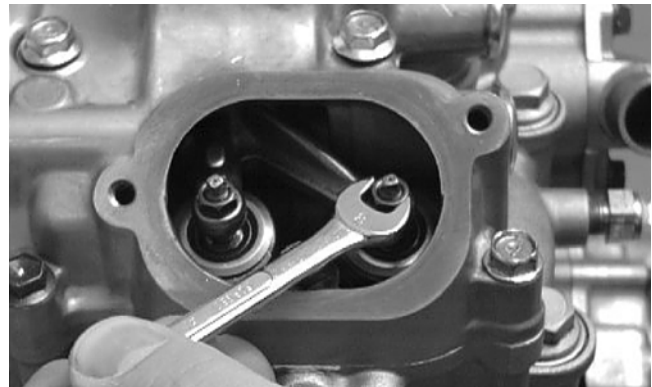

CC005D

2. Place a strip of plasti-gauge in each of the camshaft lands in the cylinder head.
3. Place the valve cover on the cylinder head and secure with the valve cover cap screws. Tighten securely.

■ **NOTE:** Do not rotate the camshaft when measuring clearance.

4. Remove the cap screws securing the valve cover to the cylinder; then remove the valve cover and camshaft.



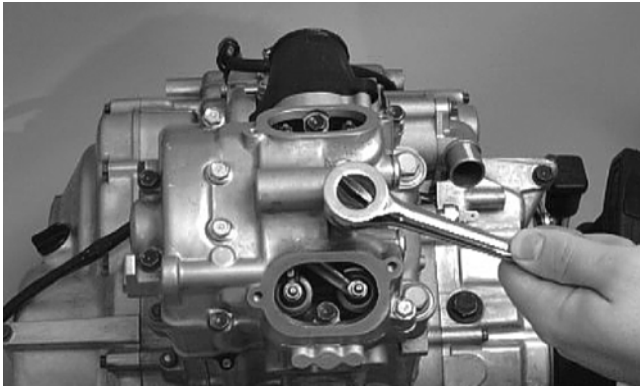

CC003D

- Match the width of the plasti-gauge with the chart found on the plasti-gauge packaging to determine camshaft to cylinder head and valve cover clearance.

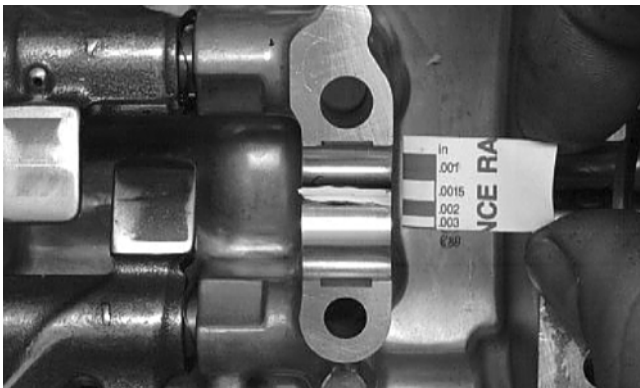

CC145D

- If clearance is excessive, measure the journals of the camshaft.

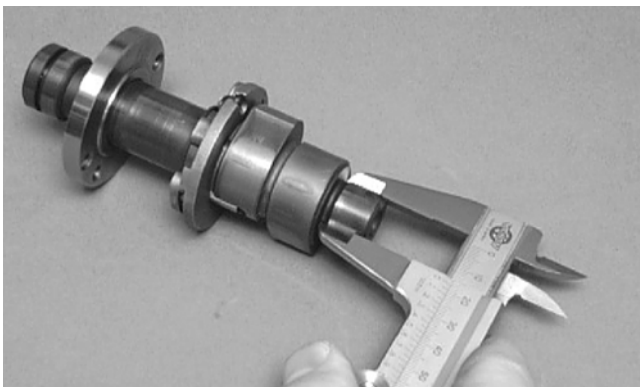

CC287D

■ **NOTE:** If the journals are worn, replace the camshaft; then measure the clearance again. If it is still out of tolerance, replace the cylinder head.

### Inspecting Camshaft Spring/Drive Pin

- Inspect the spring and drive pin for damage.

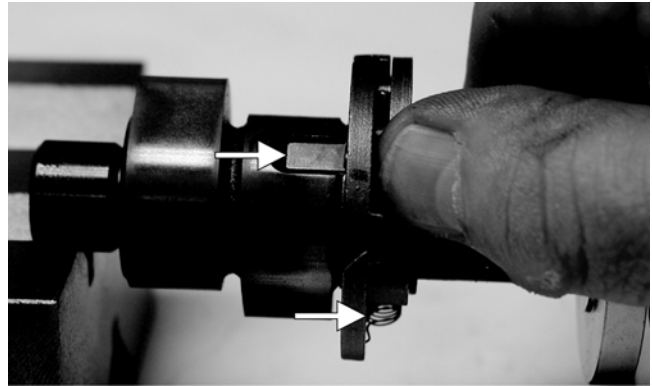

CF061A

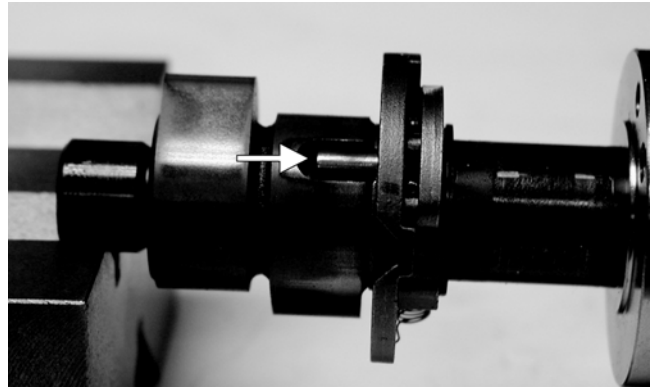

CF060A

- If damaged, the camshaft must be replaced.

---



---

## Servicing Left-Side Components

---

■ **NOTE:** Whenever a part is worn excessively, cracked, damaged in any way, or out of tolerance, replacement is necessary.

### INSPECTING CENTRIFUGAL CLUTCH SHOE

- Inspect the clutch shoes for uneven wear, chips, cracks, or discoloration. If any shoe is damaged, replace the complete set.
- Inspect the clutch shoes for wear or damage. If any shoe is worn to the bottom of the groove, replace the complete set.

⚠ **CAUTION**

Always replace the clutch shoes as a complete set or severe imbalance could occur.

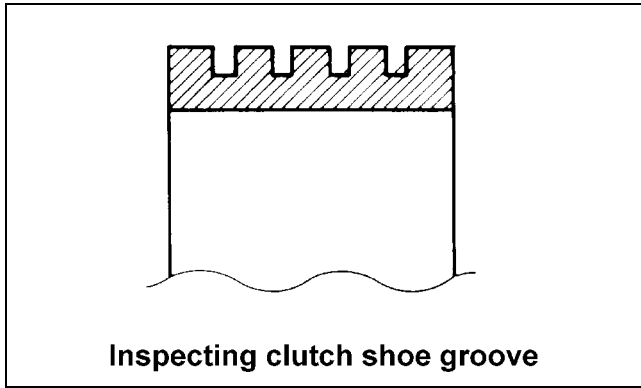

Inspecting clutch shoe groove

ATV1014

### INSPECTING CLUTCH HOUSING

1. Inspect the clutch housing for burns, grooving, cracks, or uneven wear.
2. If the housing is damaged in any way, the housing must be replaced.

### INSPECTING PRIMARY ONE-WAY DRIVE

1. Insert the drive into the clutch housing.
2. Rotate the inner race by hand and verify the inner race rotates only one direction.
3. If the inner race is locked in place or rotates both directions, the drive assembly must be replaced.

### INSPECTING OIL PUMP

1. Inspect the pump for damage.
2. It is inadvisable to remove the screw securing the pump halves. If the oil pump is damaged, it must be replaced.

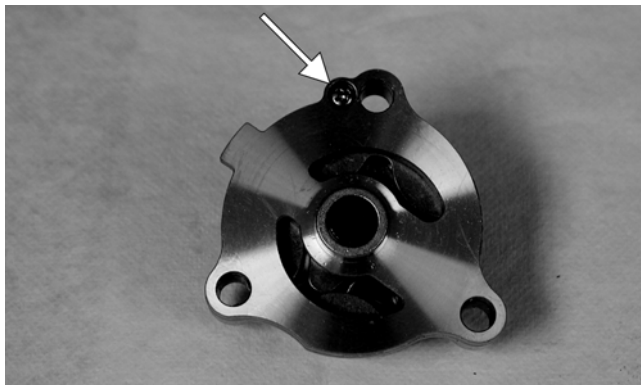

CD988A

## DRIVEN PULLEY ASSEMBLY

### Disassembling

#### WARNING

This procedure involves relaxing a compressed spring assembly. DO NOT attempt disassembling without the proper tools.

1. Secure Driven Pulley Compressor (p/n 0444-121) in a suitable holding fixture such as a bench vise; then remove the wing nut, holding handle, flat washer, and pilot bushing leaving the large spacer on the compressor tool base.

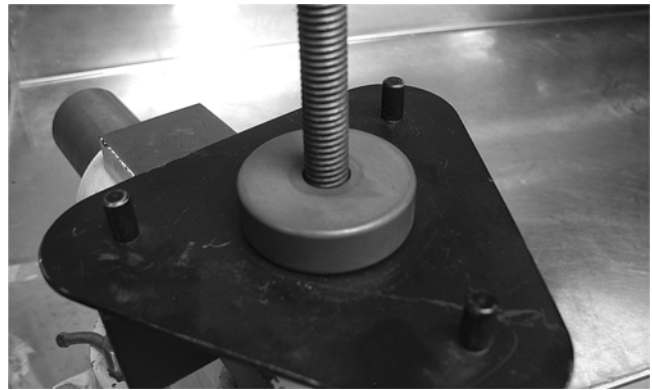

CD047

2. Place the driven pulley assembly onto the compressor tool base engaging the dowel pins into appropriate holes in the fixed face of the assembly.

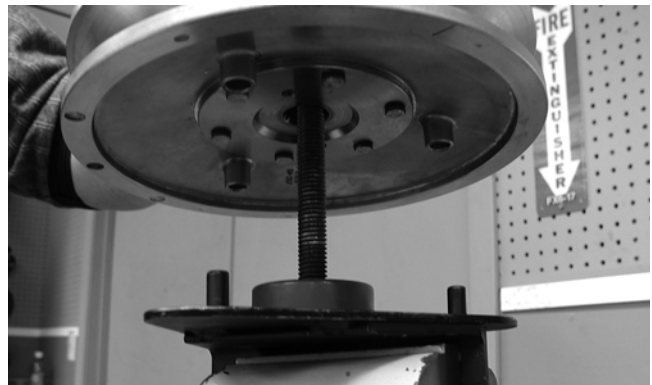

CD048

3. Install the pilot bushing with the machined end directed down; then fit the bushing into the pulley hub.

3



CD067

- Using a suitable marking pen, make alignment marks on the fixed face spring holder and both pulley faces.

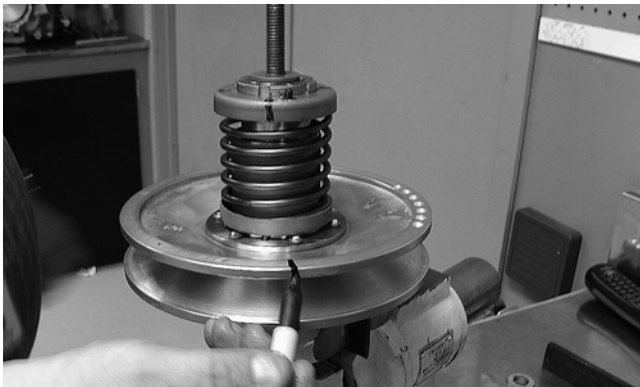

CD049

- Place the holding handle on the spring holder fitting the two dowel pins into the spring holder face; then install a flat washer and the wing nut. Turn the wing nut down until resistance is felt.

■ **NOTE:** Do not use the wing nut to compress the spring further.



CD050

**⚠ WARNING**

The spring assembly is under pressure. Extreme care must be taken when relaxing the spring. Always wear safety glasses. Use proper tools only.

- Using a spanner and suitable breaker bar, loosen the notched-ring nut; then spin the nut free of the hub.



CD051

- Firmly hold the handle and slowly turn the wing nut counterclockwise to relax the spring.

■ **NOTE:** There will be a tendency for the handle to rotate clockwise approximately  $\frac{1}{4}$  turn as the spring holder clears the flats or hub. This is due to a slight counterclockwise preload on the spring.



CD052

- Release the preload slowly; then continue to relax the spring until the wing nut is flush with the end of the threads.

- Firmly holding the spring and spring holder, remove the wing nut; then remove the spring.



CD053



- Using a thin pry-bar or screwdriver, work the movable face sleeve upward and free of the O-rings; then remove the sleeve.



CD054

- Remove the four pins and spacers from the cam slots in the movable face; then remove the movable face.



CF091

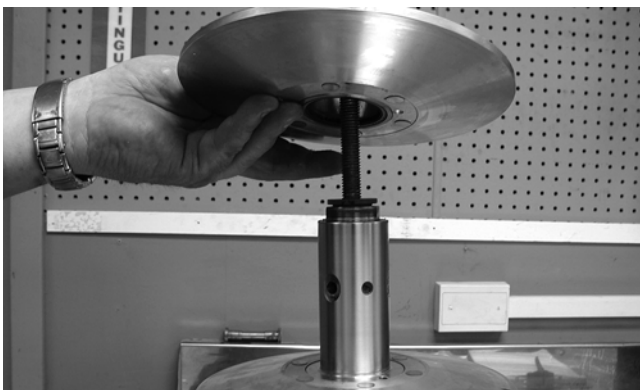

CD056

### Inspecting

- Inspect the pulley faces for wear, galling, or grooving.
- Inspect the O-rings on the movable face for nicks, tears, or swelling.



CF092A

- Inspect two grease seals in the movable face for nicks, cuts, or damage.



CF095A

- Inspect the pins and bushings for wear, flat spots, looseness, or cracking.

3

### Assembling

- Place the fixed face of the driven pulley on the pulley compressor base making sure the dowel pins are engaged in the appropriate holes in the pulley face.

■ **NOTE:** Make sure the spacer is on the base or damage to the fixed face will occur when the spring is compressed.

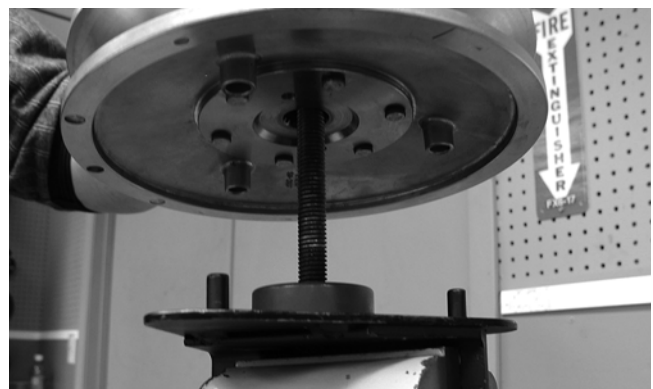

CD048

2. Apply multi-purpose grease to the O-rings and grease seals on the movable face; then install on the fixed face making sure the alignment marks are properly aligned.



CD060

3. Install the four pins and spacers into the fixed face hub; then pack the cam slots in the movable face with multi-purpose grease.



CF095A

4. Install the movable face sleeve aligning the hole in the spring seat with the spring anchor hole in the movable face.

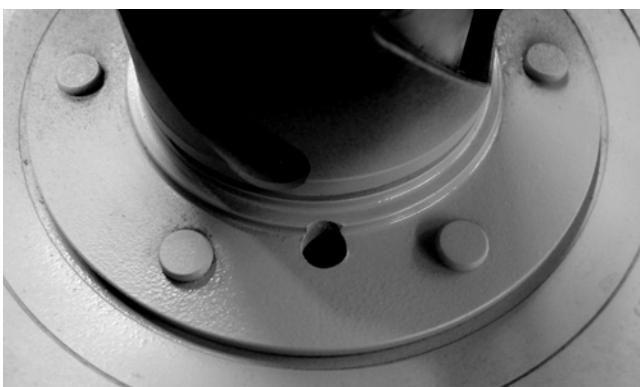

CF097

5. Install the spring over the hub and movable face sleeve; then insert the end of the spring through the sleeve and into the spring anchor hole in the movable face.

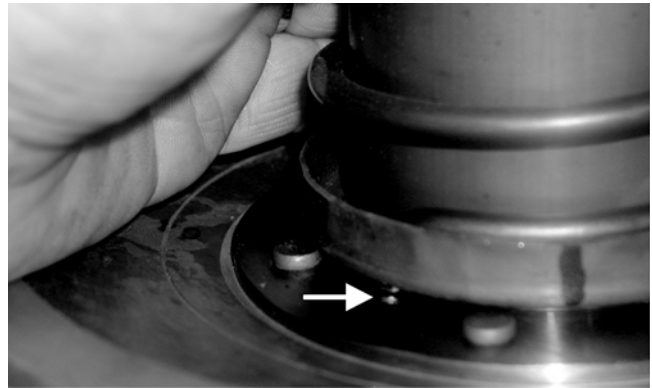

CF089A

6. Place the spring holder on the spring engaging the spring end with the appropriate anchor hole.

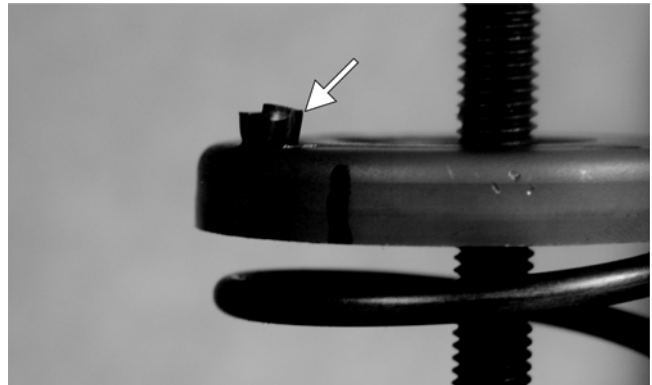

CF087A

7. Assemble the notched-ring nut, spring holding handle, one flat washer, and the wing nut in order on the pulley compressor bolt; then thread the wing nut onto the bolt.



CD052

8. Compress the spring until the spring holder nears the threads on the fixed face hub; then using the handle, wind the spring holder counterclockwise to align the flats of the spring holder and hub.

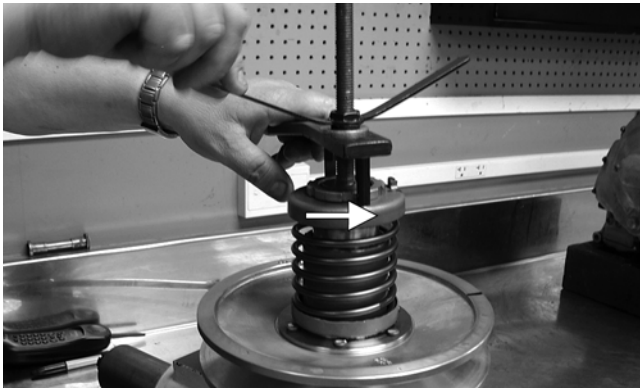

CD052A

9. Continue compressing the spring while guiding the spring holder onto the hub. When a slight resistance is felt, stop turning the wing nut.
10. Install the nut (threads coated with red Loctite #271); then tighten the nut to specification using the spanner and a torque wrench.



CD066

11. Remove the wing nut, washer, and holding handle; then remove the driven pulley from the pulley compressor.

## Servicing Center Crankcase Components

■ **NOTE:** Whenever a part is worn excessively, cracked, damaged in any way, or out of tolerance, replacement is necessary.

### SECONDARY GEARS

■ **NOTE:** When checking and correcting secondary gear backlash and tooth contact, the universal joint must be secured to the front shaft or false measurements will occur.

### Checking Backlash

■ **NOTE:** The rear shaft and bevel gear must be removed for this procedure. Also, always start with the original shims on the rear shaft.

1. Place the left-side crankcase cover onto the left-side crankcase half to prevent runout of the secondary transmission output shaft.
2. Install the secondary driven output shaft assembly onto the crankcase.
3. Mount the dial indicator so the tip is contacting a tooth on the secondary driven bevel gear.
4. While rocking the driven bevel gear back and forth, note the maximum backlash reading on the gauge.
5. Acceptable backlash range is 0.05-0.33 mm (0.002-0.013 in.).

### Correcting Backlash

■ **NOTE:** If backlash measurement is within the acceptable range, no correction is necessary.

1. If backlash measurement is less than specified, remove an existing shim, measure it, and install a new thinner shim.
2. If backlash measurement is more than specified, remove an existing shim, measure it, and install a thicker shim.

■ **NOTE:** Continue to remove, measure, and install until backlash measurement is within tolerance. Note the following chart.

Backlash Measurement	Shim Correction
Under 0.05 mm (0.002 in.)	Decrease Shim Thickness
At 0.05-0.33 mm (0.002-0.013 in.)	No Correction Required
Over 0.33 mm (0.013 in.)	Increase Shim Thickness

### Checking Tooth Contact

■ **NOTE:** After correcting backlash of the secondary driven bevel gear, it is necessary to check tooth contact.

1. Remove the secondary driven output shaft assembly from the left-side crankcase half.
2. Clean the secondary driven bevel gear teeth of old oil and grease residue.
3. Apply a thin, even coat of a machinist-layout dye to several teeth of the gear.



4. Install the secondary driven output shaft assembly.
5. Rotate the secondary driven bevel gear several revolutions in both directions.
6. Examine the tooth contact pattern in the dye and compare the pattern to the illustrations.

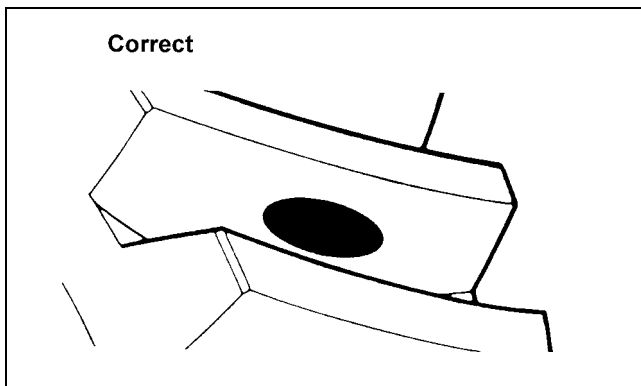
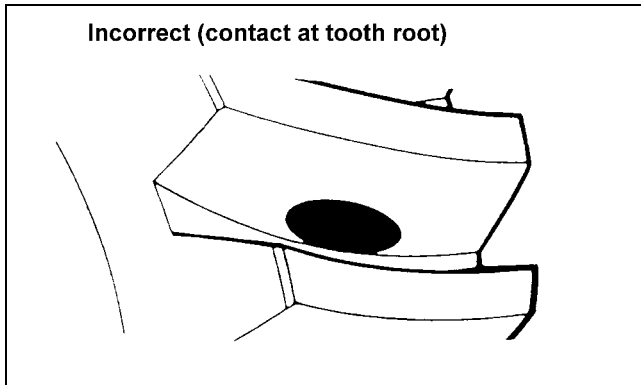
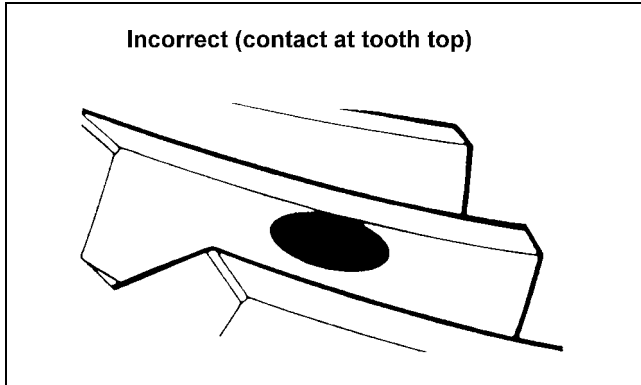

### Correcting Tooth Contact

■ **NOTE:** If tooth contact pattern is comparable to the correct pattern illustration, no correction is necessary.

If tooth contact pattern is comparable to an incorrect pattern, correct tooth contact according to the following chart.

Tooth Contact	Shim Correction
Contacts at Top	Decrease Shim Thickness
Contacts at Root	Increase Shim Thickness

■ **NOTE:** To correct tooth contact, steps 1 and 2 (with NOTE) of “Correcting Backlash” must be followed and the above “Tooth Contact/Shim Correction” chart must be consulted.

**⚠ CAUTION**

After correcting tooth contact, backlash must again be checked and corrected (if necessary). Continue the correcting backlash/correcting tooth contact procedures until they are both within tolerance values.

### CRANKSHAFT ASSEMBLY

#### Measuring Connecting Rod (Small End Inside Diameter)

1. Insert a snap gauge into the upper connecting rod small end bore; then remove the gauge and measure it with micrometer.

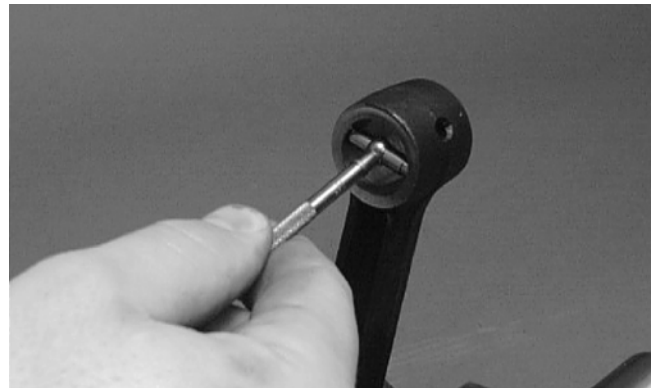

2. Maximum diameter must not exceed specifications.

### Measuring Connecting Rod (Small End Deflection)

1. Place the crankshaft on a set of V-blocks and mount a dial indicator and base on the surface plate. Position the indicator contact point against the center of the connecting rod small end journal.
2. Zero the indicator and push the small end of the connecting rod away from the dial indicator.
3. Maximum deflection must not exceed specifications.

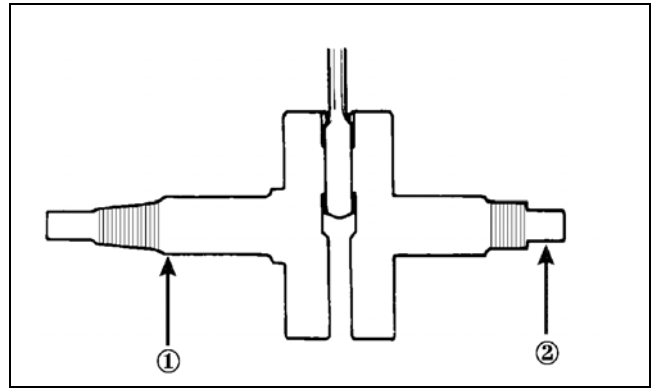

ATV-1074

### Measuring Connecting Rod (Big End Side-to-Side)

1. Push the lower end of the connecting rod to one side of the crankshaft journal.
2. Using a feeler gauge, measure the gap between the connecting rod and crankshaft journal.

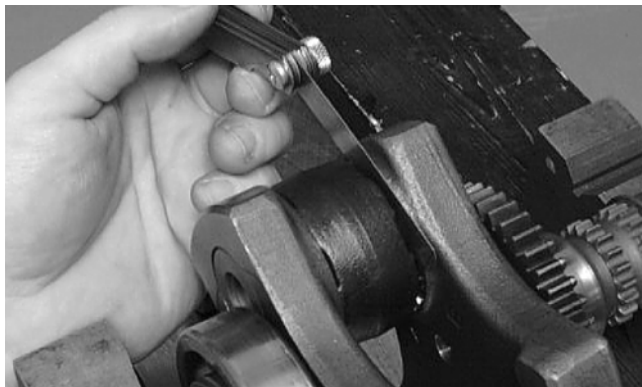

CC289D

3. Acceptable gap range must be within specifications.

### Measuring Connecting Rod (Big End Width)

1. Using a calipers, measure the width of the connecting rod at the big-end bearing.
2. Acceptable width range must be within specifications.

### Measuring Crankshaft (Runout)

1. Place the crankshaft on a set of V blocks.
2. Mount a dial indicator and base on the surface plate. Position the indicator contact at point 1 of the crankshaft.

3. Zero the indicator and rotate the crankshaft slowly.



4. Maximum runout must not exceed specifications.

■ **NOTE:** Proceed to check runout on the other end of the crankshaft by positioning the indicator contact at point 2 and following steps 2-4.

### Measuring Crankshaft (Web-to-Web)

1. Using a calipers, measure the distance from the outside edge of one web to the outside edge of the other web.

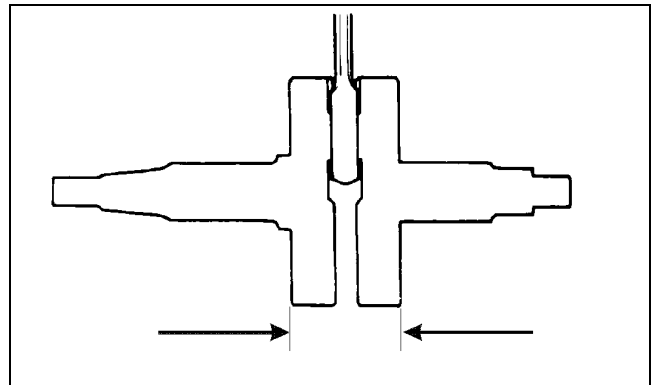

ATV-1017

2. Acceptable width range must be within specifications.

3

## COUNTERSHAFT

### ⚠ CAUTION

When disassembling the countershaft, care must be taken to note the direction each major component (dog, gear) faces. If a major component is installed facing the wrong direction, transmission damage may occur and/or the transmission will malfunction. In either case, complete disassembly and assembly will be required.

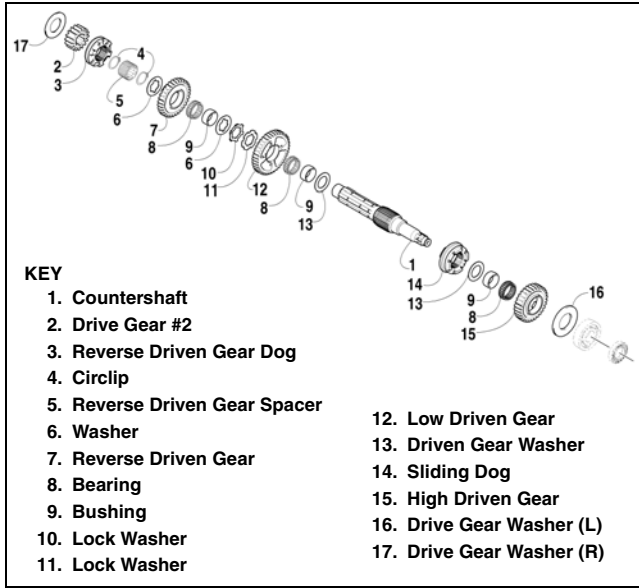

739-954A

## Disassembling

From the right side:

1. Remove the right drive gear washer (17); then remove drive gear #2 (2).
2. Remove the reverse driven gear dog (3); then remove the circlip (4).
3. Remove the reverse driven gear spacer (5); then remove the circlip (4).
4. In order, remove washer (6), reverse driven gear (7), bearing (8), and bushing (9).
5. In order, remove washer (6), lock washer (10), lock washer (11), and low driven gear (12).
6. In order, remove bearing (8), bushing (9), and driven gear washer (13).

From the left side:

1. Remove the left drive gear washer (16); then remove the high driven gear (15) and bearing (8).
2. In order, remove bushing (9), driven gear washer (13), and sliding dog (14).

## Assembling

From the left side:

1. Install the sliding dog (14), driven gear washer (13), and bushing (9).
2. Install bearing (8) and high driven gear (15); then install the left drive gear washer (16).

From the right side:

1. Install driven gear washer (13), bushing (9), bearing (8), and low driven gear (12).
2. Install lock washer (11), lock washer (10), washer (6), and bushing (9).
3. Install bearing (8), reverse driven gear (7), washer (6), and the circlip (4).
4. Install reverse driven gear spacer (5), circlip (4), reverse driven gear dog (3), and drive gear #2 (2); then install the right drive gear washer (17).

■ **NOTE:** When installing the countershaft assembly, account for the washer on each end of the shaft.

## Assembling Crankcase Half

1. Install the output shaft assembly into the crankcase making sure the two gears, shim, washer, and nut are properly sequenced.



CC686

■ **NOTE:** The beveled side of the secondary drive gear must face upward.

2. Apply red Loctite #271 to the threads of the output shaft; then secure with the nut. Tighten nut to specifications; then using a punch, peen the nut.





CC687

3. Apply a liberal amount of engine oil to the crankshaft bearing. Using a propane torch, heat the bearing until the oil begins to smoke; then slide the crankshaft assembly into place.

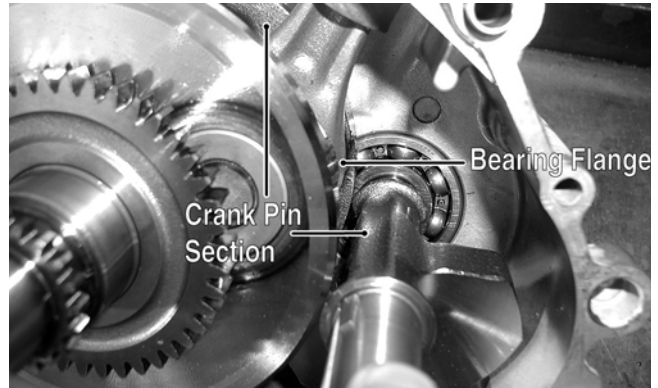

CD832B

■ **NOTE:** It will be necessary to rotate the crank balancer until the counterweight is facing away from the crankshaft; then rotate the crankshaft clockwise into the journal area to allow the crank balancer to be fully seated.

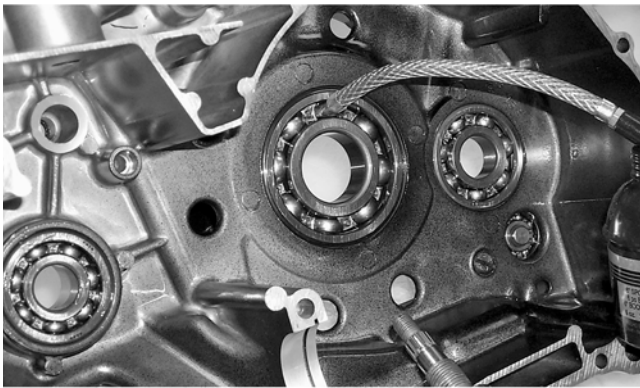

CC688

5. Place the key into the crank balancer keyway; then install the crank balancer gear making sure the alignment dots on the crank balancer gear and the crankshaft gear align.

3

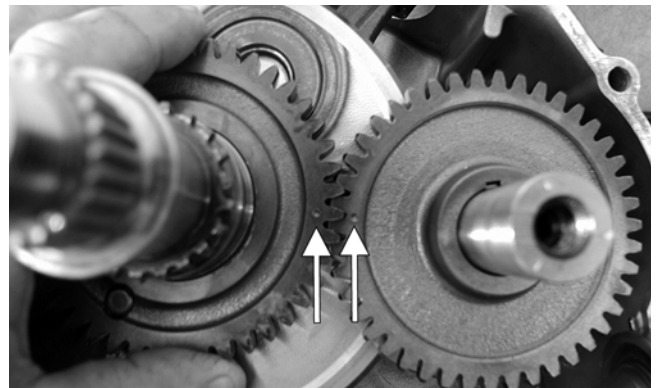

CD826A

6. Install the driveshaft.



CC689

■ **NOTE:** If heating the bearing is not possible, the crankshaft can be installed using a crankshaft installing tool.

4. Install the crank balancer.

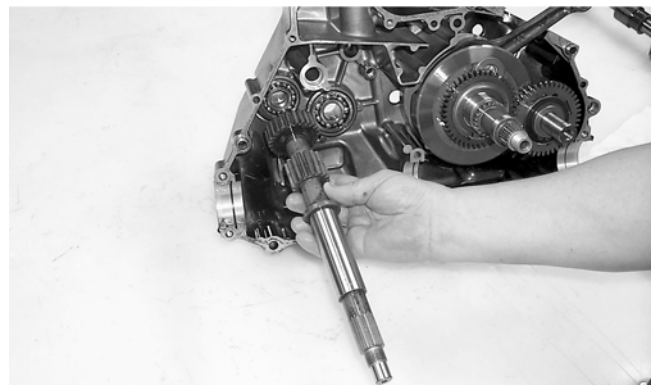

CC675

7. Place a washer on each end of the countershaft assembly; then install the assembly.

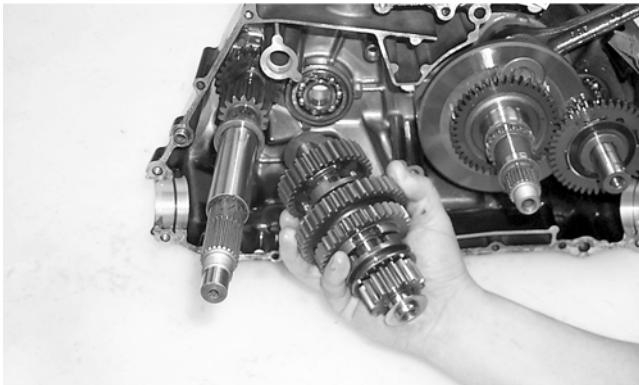

CC674

- Place a washer on each end of the gear shift shaft; then install the shaft assembly making sure the two holes on the end of the shaft are positioned vertically.
- Insert the two shift forks into the sliding dogs noting the direction of the tabs from disassembling; then install the shift fork shaft.

■ **NOTE:** Make sure the shift fork tabs face upward and that they are properly seated into the shift cams.



CC669

- Install the reverse idler gear assembly noting the positioning of the two washers, gear, bushing, and shaft.

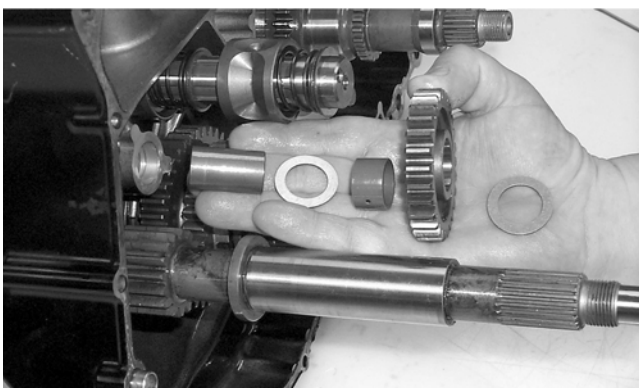

CC668

- Install the front and rear secondary driven shaft assemblies into the left side of the crankcase making sure the bearing locating pins are facing upward and the bearing C-ring is fully seated in the crankcase.

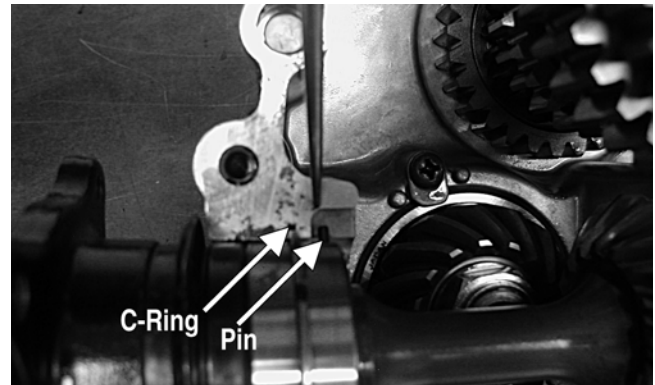

CD268A

- Place the oil strainer into position; then secure with the two screws.
- Place the oil strainer cap into position making sure the O-ring is in position; then secure the cap with cap screws. Tighten securely.

---

## Joining Crankcase Halves

---

- Apply High-Temp Sealant to the right-side mating surface.
- Lightly oil all bearings and grease all shafts in the left-side crankcase.
- Using a propane torch, heat the left-side crankshaft bearing until the oil begins to smoke; then join the two crankcase halves.



CC695

- Using a plastic mallet, lightly tap the case halves together until cap screws can be installed.
- From the left side, install the 8 mm cap screws; then tighten only until snug.



■ **NOTE:** Rotate the shafts back and forth to ensure no binding or sticking occurs.

6. From the right side, install the remaining 8 mm cap screws (two inside the case); then tighten only until snug.

■ **NOTE:** Rotate the shafts back and forth to ensure no binding or sticking occurs.

7. From the right side, install the case half 6 mm cap screws; then tighten only until snug.

■ **NOTE:** Rotate the shafts back and forth to ensure no binding or sticking occurs.

8. From the left side, install the 6 mm cap screws; then tighten only until snug.

■ **NOTE:** Rotate the shafts back and forth to ensure no binding or sticking occurs.

9. In a crisscross/case-to-case pattern, tighten the 8 mm cap screws (from steps 5-6) until the halves are correctly joined; then tighten to specifications.

■ **NOTE:** Rotate the shafts back and forth to ensure no binding or sticking occurs.

10. In a crisscross/case-to-case pattern, tighten the 6 mm cap screws (from steps 7-8) to specifications.

■ **NOTE:** Rotate the shafts back and forth to ensure no binding or sticking occurs.

**AT THIS POINT**

After completing center crankcase components, proceed to Installing Left-Side Components, to Installing Right-Side Components, and to Installing Top-Side Components.

## Installing Left-Side Components

1. Install the shift indicator sending unit making sure the two neutral contact pins and the two springs are properly positioned. Tighten the Allen-head screws securely.

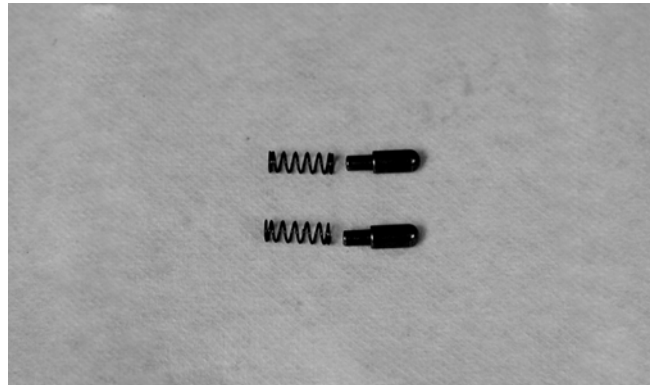

CD997

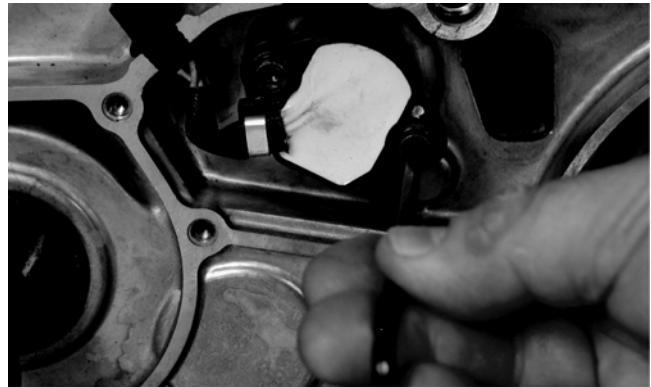

CD994

2. Install the secondary shaft bearing housing making sure the two alignment pins are properly positioned. Tighten the Allen-head screws securely.



CD999

3. Install the oil pump onto the engine; then tighten the Phillips-head screws securely.



CD988



4. Install the oil pump drive gear spacer onto the crank balancer shaft. Grease the pin and insert it into the shaft; then install the drive gear making sure the raised side of the gear is facing toward the inside. Secure the gear with the cap screw (threads coated with red Loctite #271) and the washer. Tighten the cap screw to specifications.

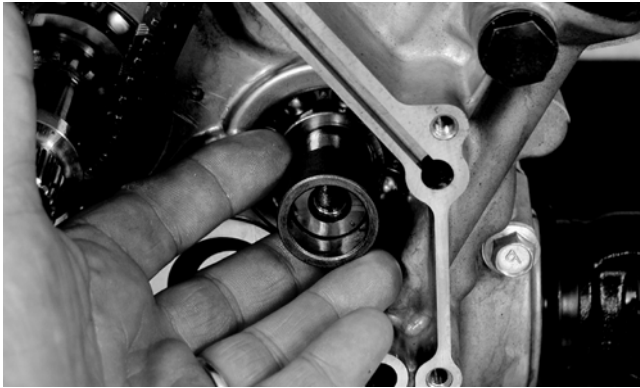

CD992



CD984

■ **NOTE:** When installed correctly, the sides of the drive and driven gears will be flush with each other.

6. Install the clutch shoe assembly and secure with the washer (with the flat side facing the assembly as noted in removing) and the nut (threads coated with red Loctite #271). Tighten to specifications.



CD991

**CAUTION**  
Care must be taken that the directional washer be installed correctly and note that the nut has left-hand threads.

5. Grease the driven gear pin and insert it into the oil pump shaft; then install the driven gear (noting the direction of the sides of the gear from removing). Secure with a snap ring.

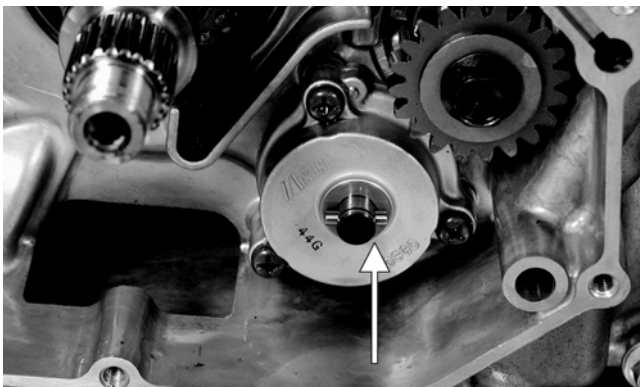

CD985A

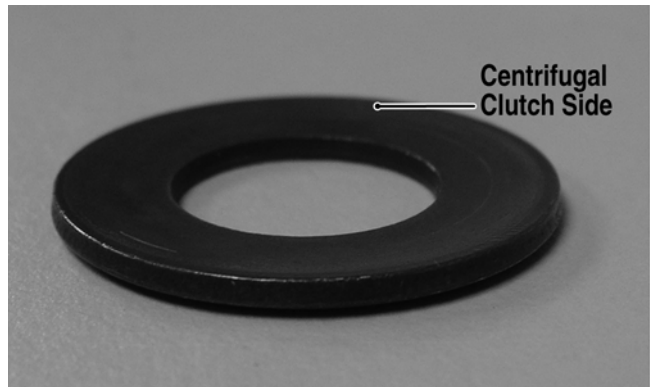

F1336A



F1279A

7. Lightly grease the clutch housing seal; then insert the left fixed drive spacer.

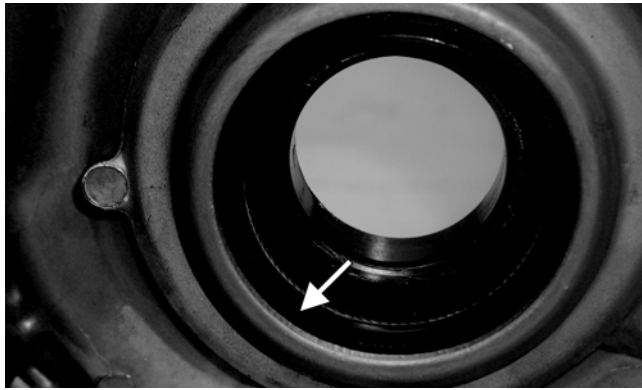

8. Install the clutch cover alignment pins into the crankcase, apply oil to the cover gasket, and install the gasket onto the crankcase.
9. Apply grease to the outer edges of the clutch housing; then from inside the clutch cover, install the clutch housing into the cover using a rubber mallet.
10. Install the one-way clutch onto the clutch shoe assembly.

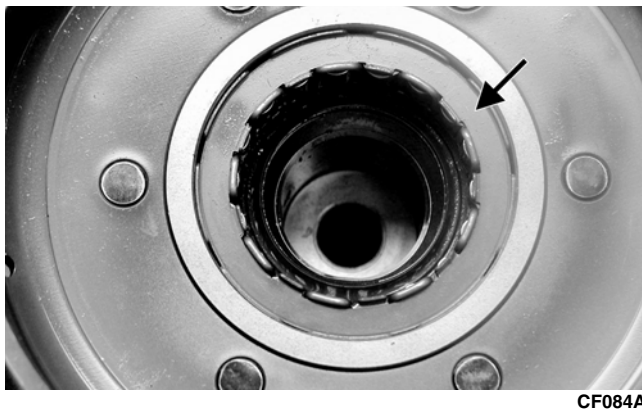

**CAUTION**  
When installed correctly, the green dot (or the word OUTSIDE) on the one-way clutch is visible.

11. Place the clutch cover/clutch housing assembly into position on the crankcase; then secure with the cap screws making sure the different-lengthed cap screws are in their proper location. Tighten to specifications.
12. Place the air intake plate cushion into position; then install the air intake plate. Tighten the cap screws (threads treated with a small amount of red Loctite #271) securely.

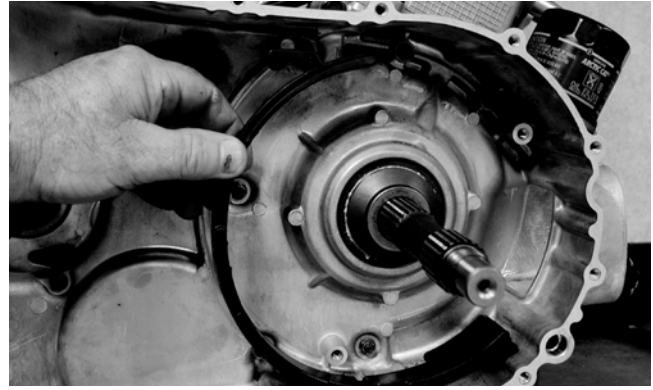

3



13. Place the driven pulley assembly into position and secure with the nut. Tighten to specifications.

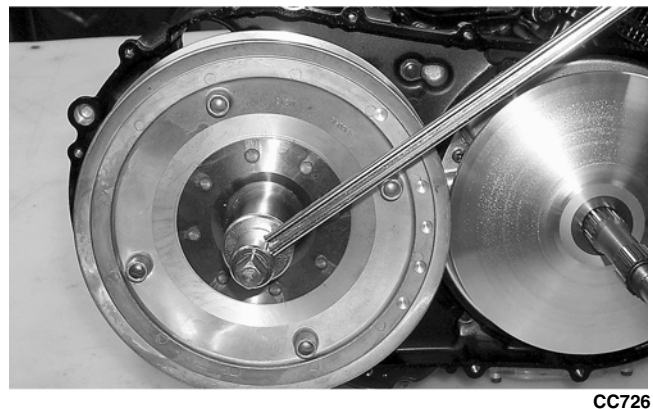

14. Slide the fixed drive face onto the shaft.



15. Spread the faces of the driven pulley by pushing the inner face toward the engine while turning it counterclockwise; then when the faces are separated, insert a wedge (approximately 3/8 in. thick) between the faces. Release the inner face.
16. Place the V-belt into position on the driven pulley and over the front shaft.

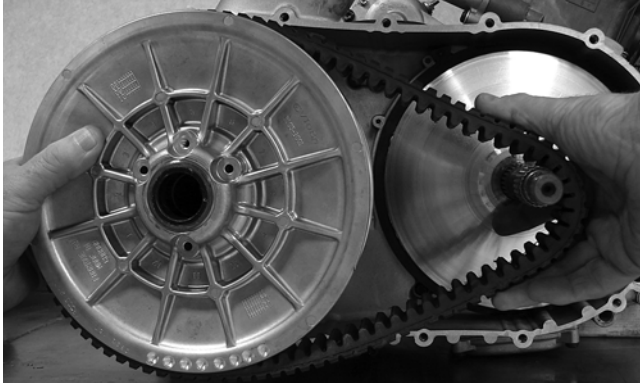

■ **NOTE:** The arrows on the V-belt should point forward.

17. Pinch the V-belt together near its center and slide the spacer and movable drive face onto the shaft. Secure the drive face with a nut (threads coated with red Loctite #271). Tighten the nut to specifications.

**CAUTION**

Make sure the splines extend beyond the drive face or a false torque reading and spline damage may occur.



■ **NOTE:** At this point, the wedge can be removed from between the driven pulley faces.

18. Rotate the V-belt and drive/driven assemblies until the V-belt is flush with the top of the driven pulley.

19. Place the V-belt cover gasket into position; then install the cover and secure with the cap screws making sure the different-lengthed cap screws are in their proper location. Tighten the cap screws to specifications.

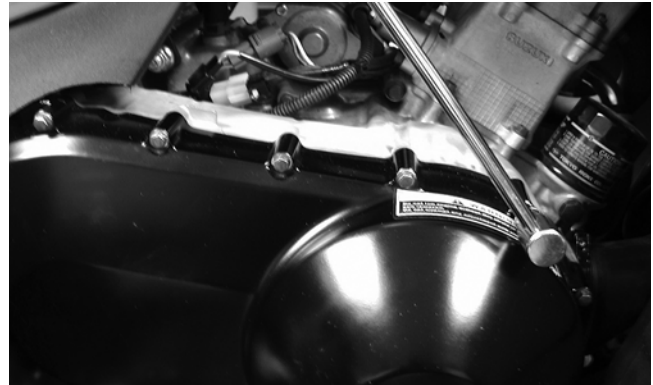

## Installing Right-Side Components

■ **NOTE:** Plug the oil passage in the crankcase housing prior to installing the drive gear/driven gear assembly to prevent loss of an alignment pin.

1. Install the water pump driven gear alignment pin and the driven gear (with the beveled side of the gear facing outward as noted in removing); then secure with the snap ring.

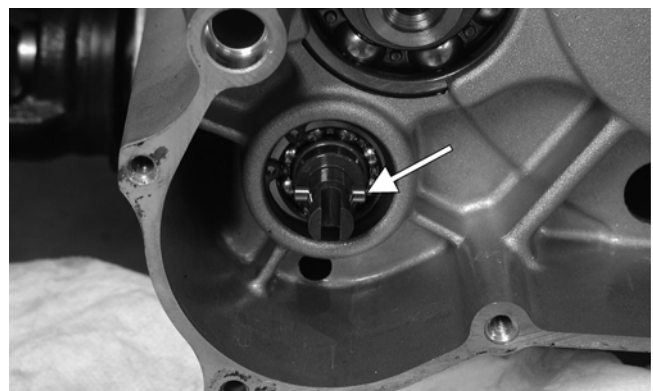



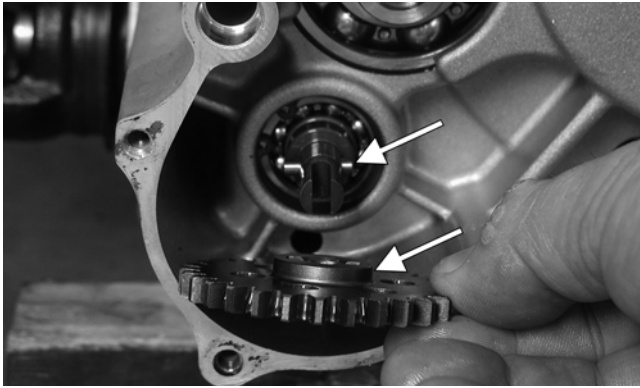

CD952A



CD944

■ **NOTE:** The sharp side of the snap ring should be facing outward.

■ **NOTE:** Once the gears are secured, remove the oil passage plug from the crankcase.

3. Install the two starter gear shafts; then install the two starter gears (with the beveled side of the intermediate gear facing inward as noted in removing).

**3**

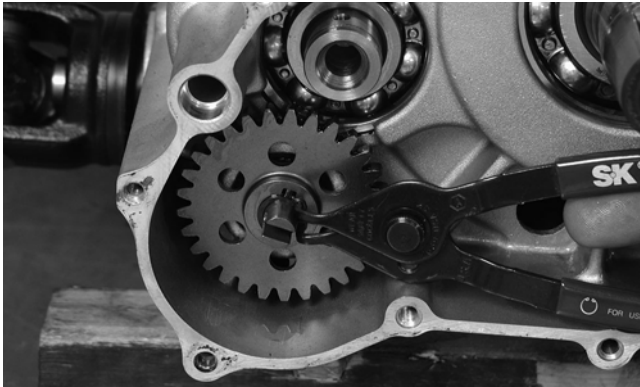

CD949

■ **NOTE:** The sharp side of the snap ring should be facing outward.

2. Install the water pump drive gear drive pin and the drive gear (with the flat side of the gear facing outward as noted in removing); then secure with the snap ring.



CD139

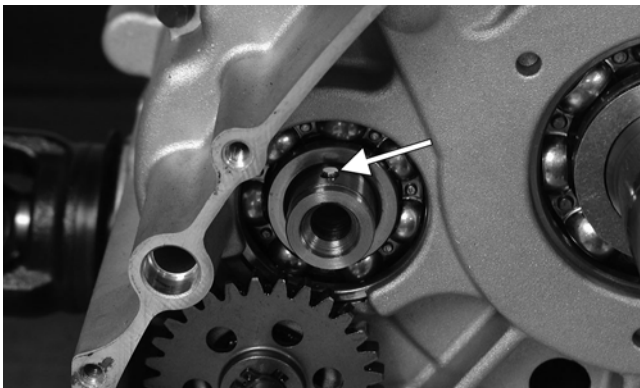

CD946A

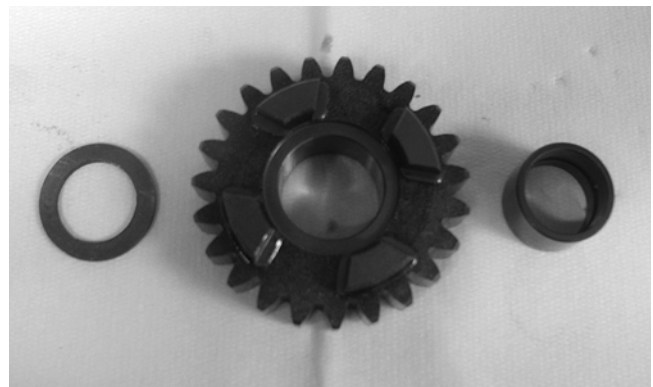

CD145

4. In order on the crankshaft, install a washer, ring gear, key, and the magneto rotor. Secure with the nut (threads coated with red Loctite #271). Tighten to specifications.

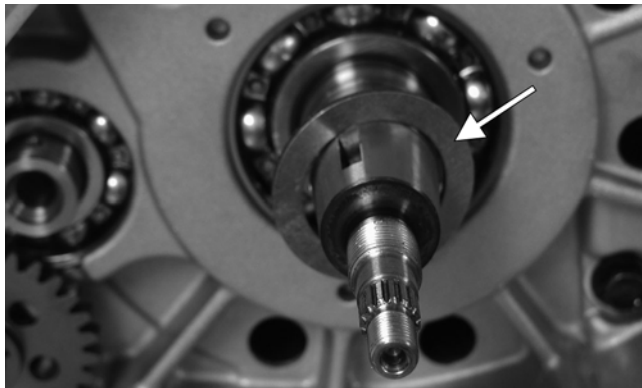

CD948A

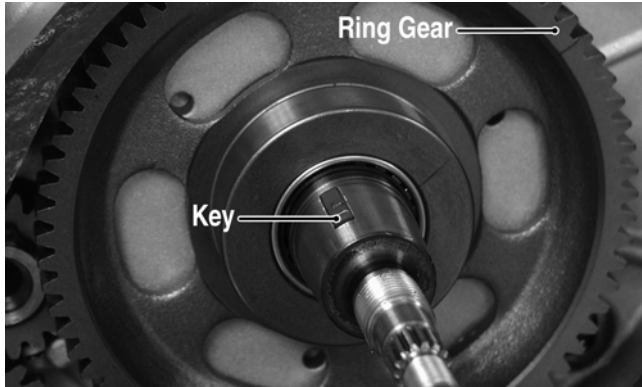

CD940B

5. Install the shift cam plate onto the shift cam shaft; then coat the cap screw threads with red Loctite #271 and tighten securely.

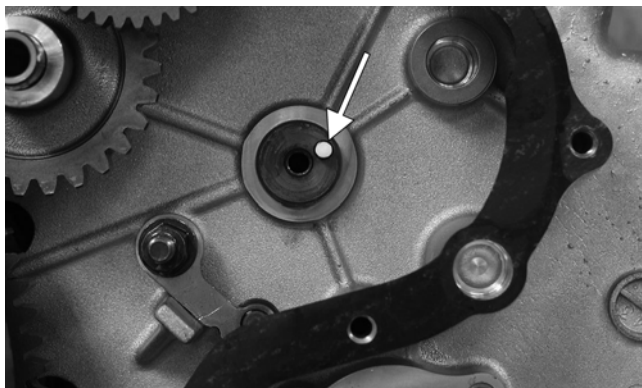

CD935A



CD934

6. Install the shift cam stopper, spring, and two washers; then coat the threads on the mounting stud with red Loctite #271 and install the nut. Tighten securely.

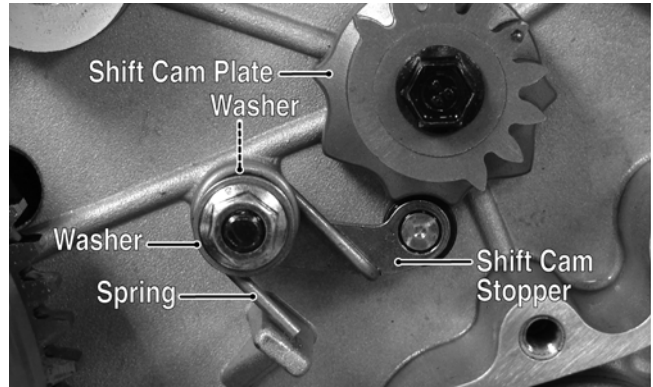

PR434A

7. Install the shift shaft with two washers making sure to align the timing mark on the shift shaft with the mark on the shift cam plate.

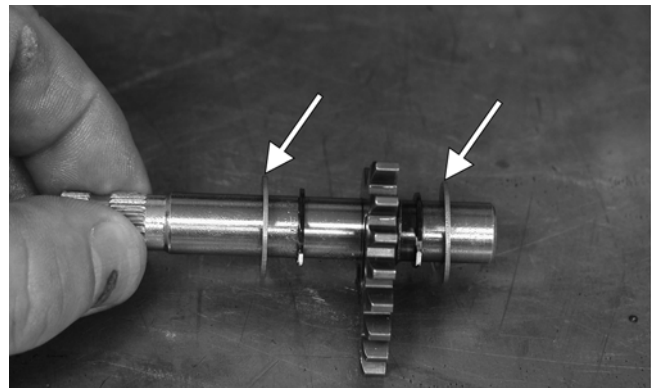

CD954A

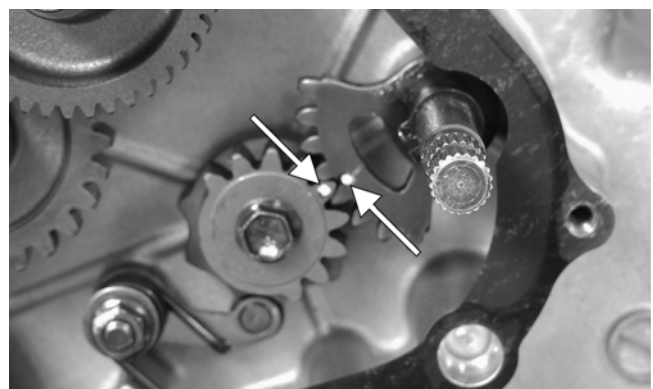

CD927A

8. Lubricate the magneto cover gasket with fresh engine oil; then place it into position on the two alignment pins. Make sure the outer shift shaft washer is in place.



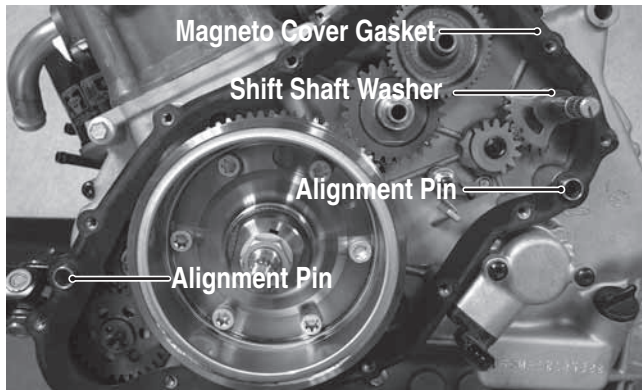

PR431A

9. Install the magneto cover and secure with the cap screws. Tighten only until snug.
10. Place the spacer into position on the crankshaft making sure a new, lubricated O-ring is inside the spacer. Tighten the flange nut to specifications.



PR465

11. Tighten the cap screws (from step 9) to specifications.
12. Place the speed sensor housing and gasket into position and secure with the two cap screws. Tighten securely.

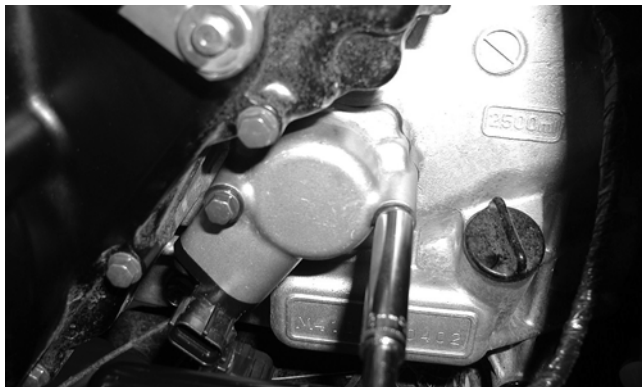

CD069

13. Place the water pump into position and secure with two cap screws. Tighten securely.

14. Install the crossover tube on the water pump and cylinder head making sure the O-ring is properly positioned.
15. Install the shift arm on the shift arm shaft making sure the scribed marks (from removing) are aligned. Tighten securely.
16. Place the gasket and outer magneto cover into position on the right-side cover; then tighten four screws to specifications.

## Installing Top-Side Components

- A. Piston
- B. Cylinder

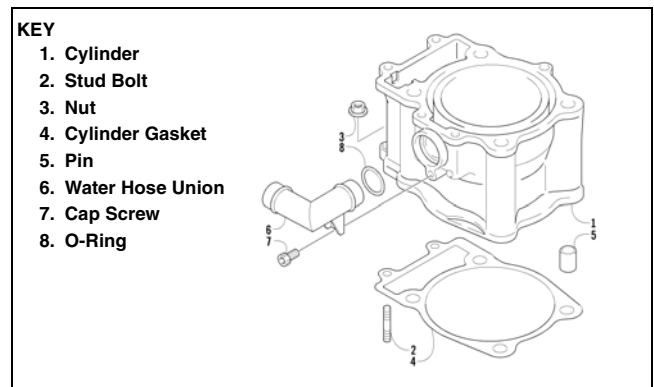

0732-301

■ **NOTE:** If the piston rings were removed, install them in this sequence.

- A. Install ring expander (4) in the bottom groove of the piston; then install the thin oil rings (3) over the expander making sure the expander ends do not overlap. Stagger the end gaps of the upper and lower thin oil rings according to the illustration.

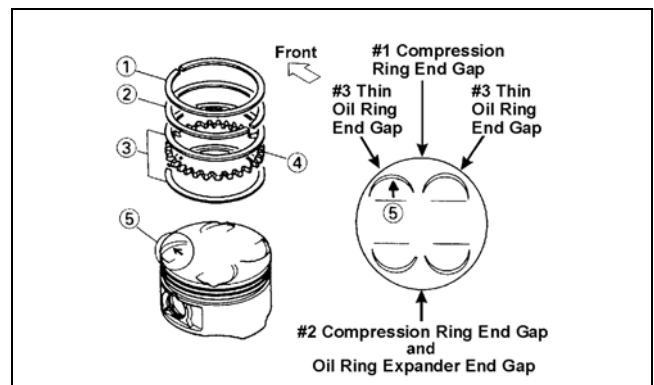

ATV-1085B

■ **NOTE:** Note the direction of the exhaust side of the piston (5) for correct ring end gap orientation.



B. Install the compression rings (1 and 2) so the letter on the top surface of each ring faces the dome of the piston. Rotate the rings until the ring end gaps are on directly opposite sides of the piston (see illustration).

■ **NOTE:** The ring with the orientation mark (M TOP) should be installed in the second (middle) groove and the ring with the orientation mark (M) should be installed in the first (top) groove.

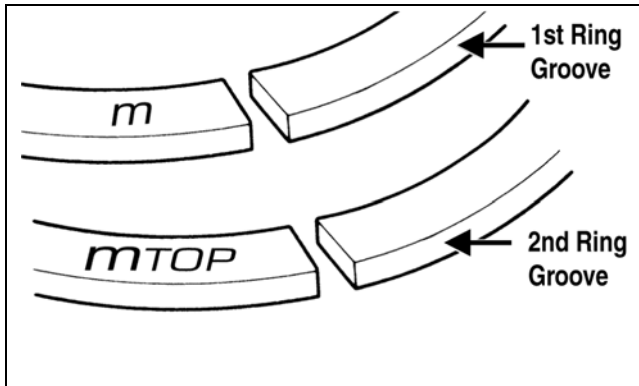

ATV-1024A

**CAUTION**

Incorrect installation of the piston rings will result in engine damage.

1. Install the piston on the connecting rod making sure there is a circlip on each side and the open end of the circlip faces upwards.

■ **NOTE:** The piston should be installed so the arrow points toward the exhaust.

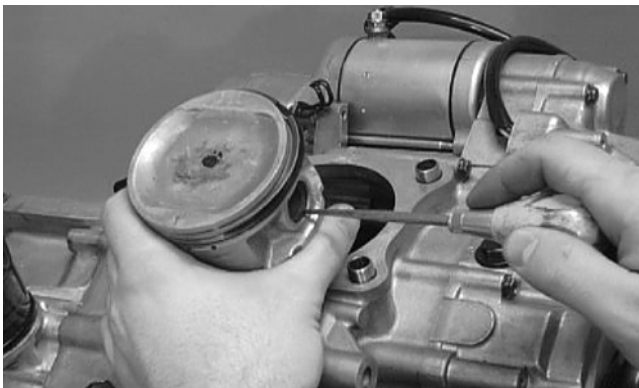

CC032D

2. Place the two alignment pins into position. Place the cylinder gasket into position; then place a piston holder (or suitable substitute) beneath the piston skirt and square the piston in respect to the crankcase.

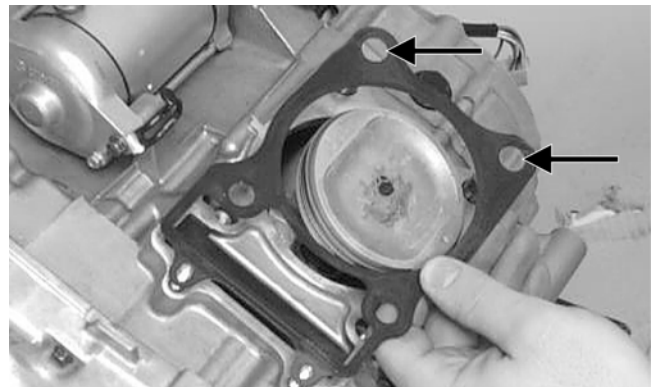

CC025D

3. Lubricate the inside wall of the cylinder; then using a ring compressor or the fingers, compress the rings and slide the cylinder over the piston. Route the cam chain up through the cylinder cam chain housing; then remove the piston holder and seat the cylinder firmly on the crankcase.

**CAUTION**

The cylinder should slide on easily. Do not force the cylinder or damage to the piston, rings, cylinder, or crankshaft assembly may occur.



CC024D

4. Loosely install the two nuts which secure the cylinder to the crankcase.

■ **NOTE:** The two cylinder-to-crankcase nuts will be tightened in step 10.

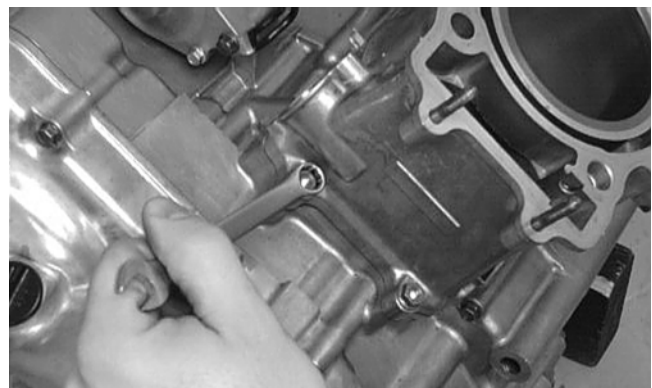

CC023D

5. Install the coolant hose onto the crankcase union and tighten the clamp.

### C. Cylinder Head

### D. Valve Cover

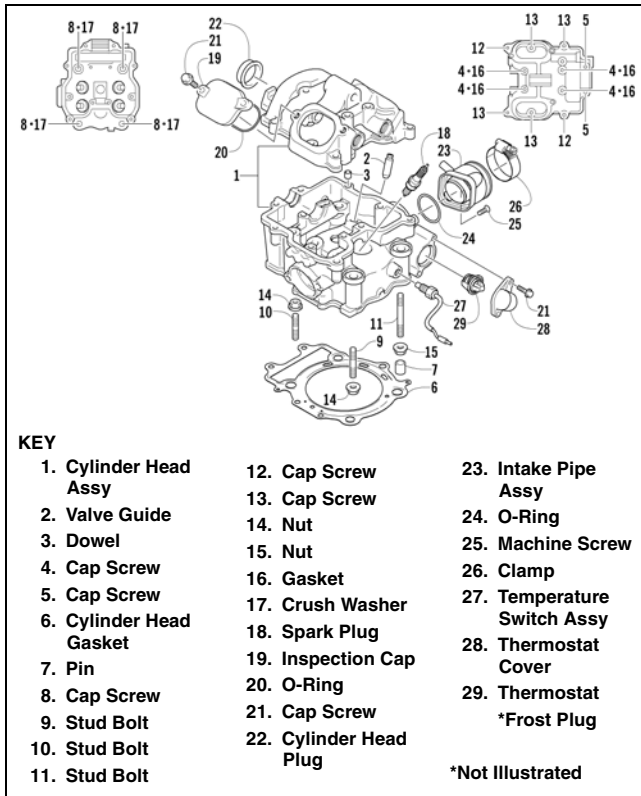

0741-101

■ **NOTE:** Steps 1-5 in the preceding sub-section must precede this procedure.

6. Place the chain guide into the cylinder.

### ⚠ CAUTION

Care should be taken that the bottom of the chain guide is secured in the crankcase boss.

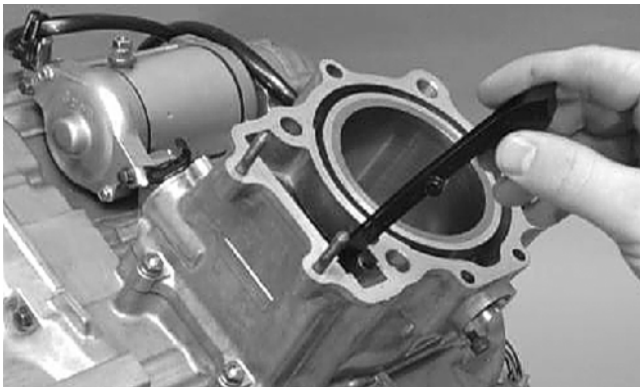

CC022D

7. Place the head gasket into position on the cylinder. Place the alignment pins into position; then place the head assembly into position on the cylinder.

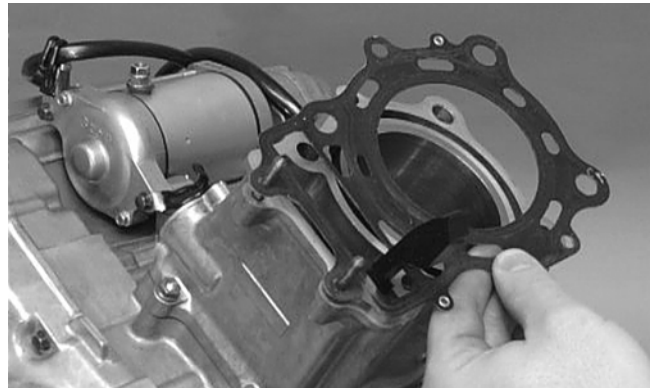

CC020D

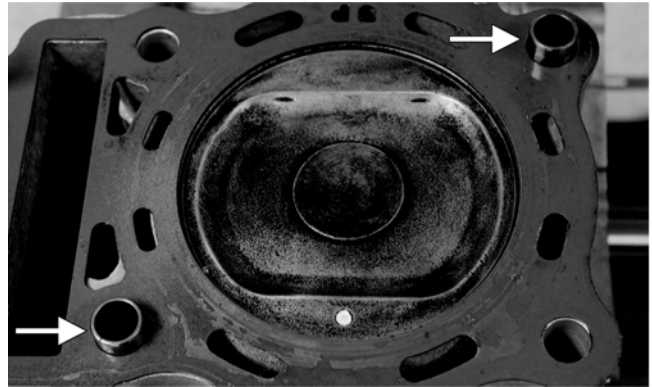

CF057A

8. Install the four cylinder head cap screws with copper washers (note the locations of the different-lengthed cap screws). Tighten only until snug.

3

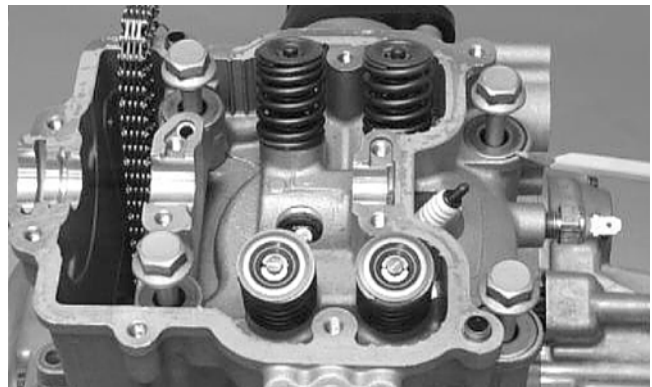

CC272D

9. Loosely install the five cylinder head nuts.

10. In a crisscross pattern, tighten the four cylinder head cap screws (from step 8) to 5.5 kg-m (40 ft-lb); then tighten the 8 mm nut (from step 9) to 2.5 kg-m (18 ft-lb). Using a crisscross pattern, tighten the 6 mm nuts (from step 9) to 1.1 kg-m (8 ft-lb). Tighten the two cylinder-to-crankcase nuts (from step 4) securely.

11. With the timing inspection plug removed and the chain held tight, rotate the crankshaft until the piston is at top-dead-center.



12. With the alignment pin installed in the camshaft, loosely place the cam sprocket (with the recessed side facing the cam shaft lobes) onto the camshaft. At this point, do not “seat” the sprocket onto the shaft.

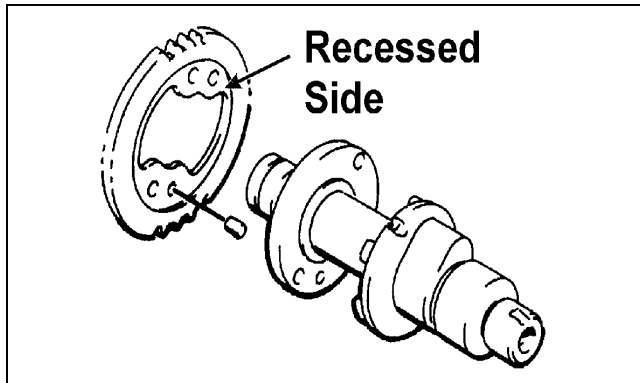

732-307B

■ **NOTE:** At this point, oil the camshaft bearings, cam lobes, and the three seating journals on the cylinder.

13. While holding the cam chain sprocket to the side, install the rear cam chain tensioner guide into the cylinder head. Install the pivot cap screw and washer.

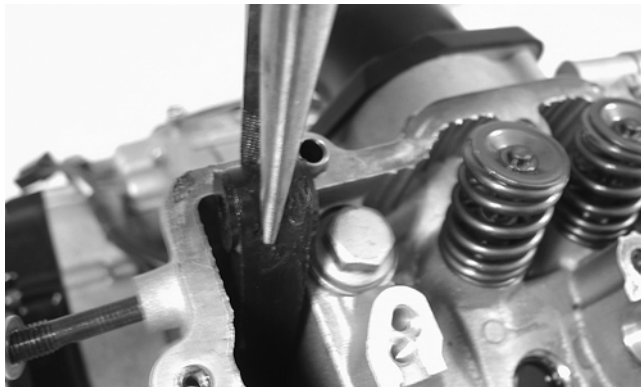

CD461

14. With the cam lobes directed down (toward the piston), maneuver the camshaft/sprocket assembly through the chain and towards its seating position; then loop the chain over the sprocket.

■ **NOTE:** Note the position of the alignment marks on the end of the camshaft. They must be parallel with the valve cover mating surface. If rotating the camshaft is necessary for alignment, do not allow the chain and sprocket to rotate and be sure the cam lobes end up in the down position.

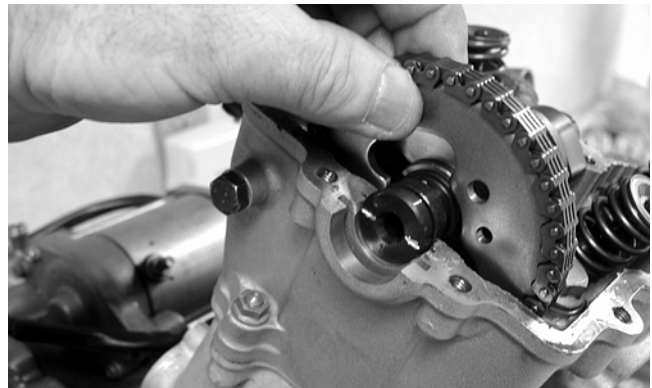

CD463

15. Seat the cam sprocket onto the camshaft making sure the alignment pin in the camshaft aligns with the smallest hole in the sprocket; then place the camshaft/sprocket assembly onto the cylinder ensuring the following.

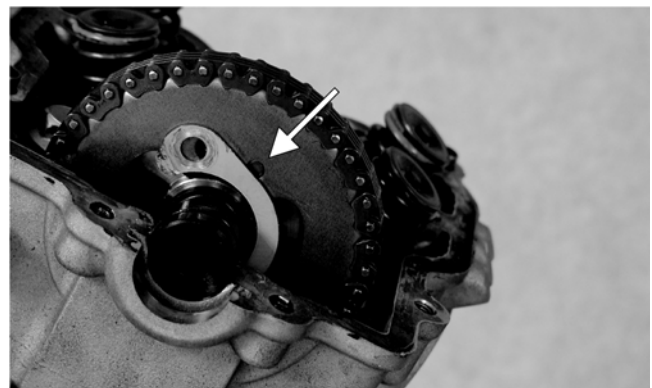

CF013A

- A. Piston still at top-dead-center.
- B. Camshaft lobes directed down (toward the piston).
- C. Camshaft alignment marks parallel to the valve cover mating surface.
- D. Recessed side of the sprocket directed toward the cam lobes.
- E. Camshaft alignment pin and sprocket alignment hole (smallest) are aligned.

**⚠ CAUTION**

If any of the above factors are not as stated, go back to step 11 and carefully proceed.

16. Place the tab-washer onto the sprocket making sure it covers the pin in the alignment hole.



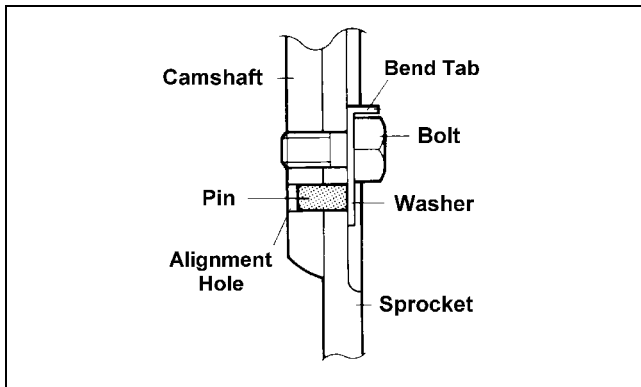

ATV1027

**CAUTION**

Care must be taken that the tab-washer is installed correctly to cover the alignment hole on the sprocket. If the alignment pin falls out, severe engine damage will result.

17. Install the first cap screw (threads coated with red Loctite #271) securing the sprocket and tab-washer to the camshaft. Tighten only until snug.



CD464

18. Rotate the crankshaft until the second cap screw securing the sprocket to the camshaft can be installed; then install the cap screw (threads coated with red Loctite #271) and tighten to specifications. Bend the tab to secure the cap screw.

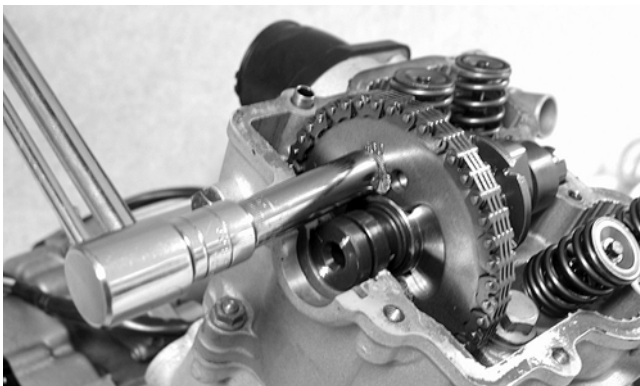

CD465

19. Rotate the crankshaft until the first cap screw (from step 17) can be addressed; then tighten to specifications. Bend the tab to secure the cap screw.

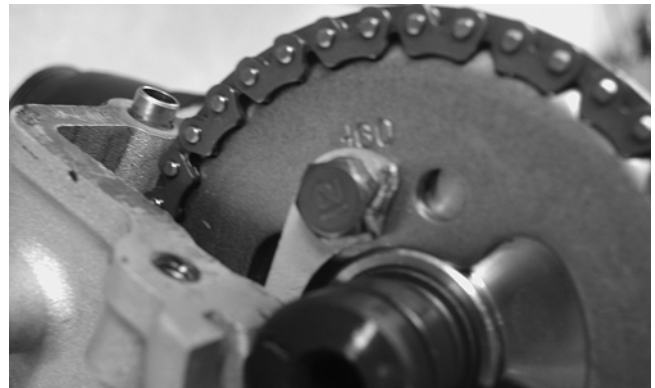

CD466

20. Place the C-ring into position in its groove in the cylinder head.



CC012D

21. Install the cylinder head plug in the cylinder head with the open end facing downward and toward the inside.

**CAUTION**

The open end of the plug must be positioned downward.

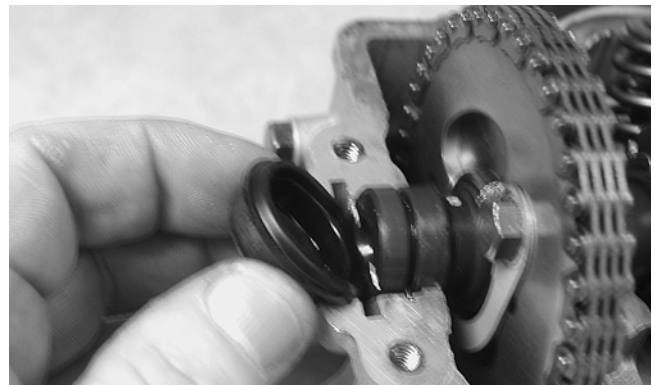

CD468

**3**

22. Remove the cap screw from the end of the chain tensioner; then using a flat-blade screwdriver, rotate the adjuster screw inside the tensioner clockwise until the screw bottoms.

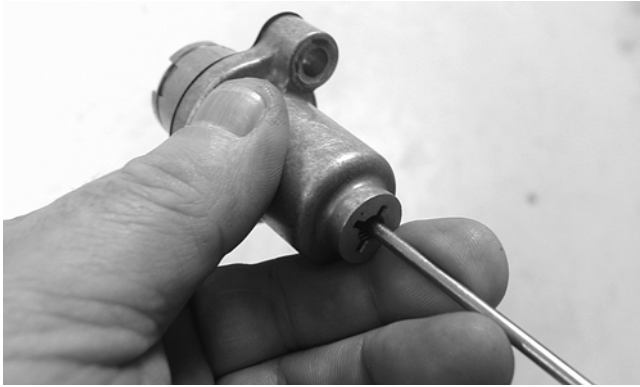

CD501

■ **NOTE:** The adjuster shaft will be drawn into the tensioner as the adjuster screw is rotated clockwise. The adjuster shaft tension will be released in step 24.

23. Place the chain tensioner adjuster assembly and gasket into position on the cylinder and secure with the two Allen-head cap screws.

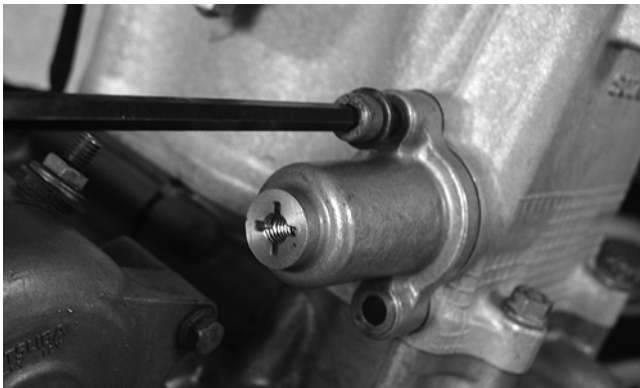

CD469

24. Using a flat-blade screwdriver, rotate the adjuster screw inside the tensioner counter-clockwise until all tension is released; then install the cap screw into the end of the chain tensioner.

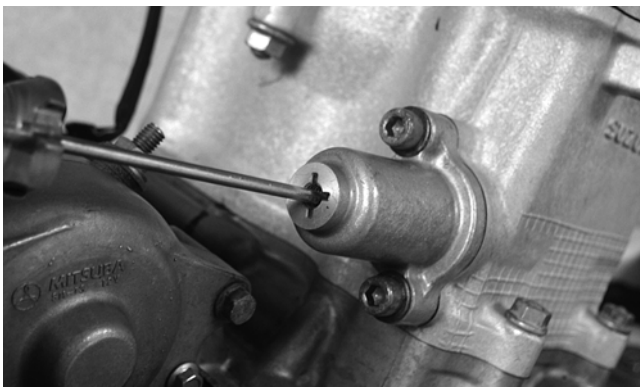

CD470

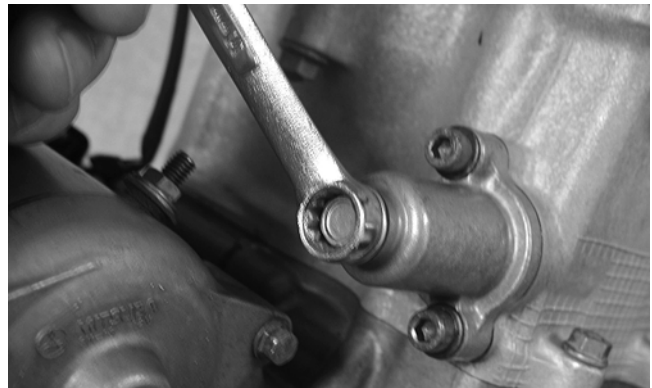

CD471

25. Loosen the four adjuster screw jam nuts; then loosen the four adjuster screws on the rocker arms in the valve cover.

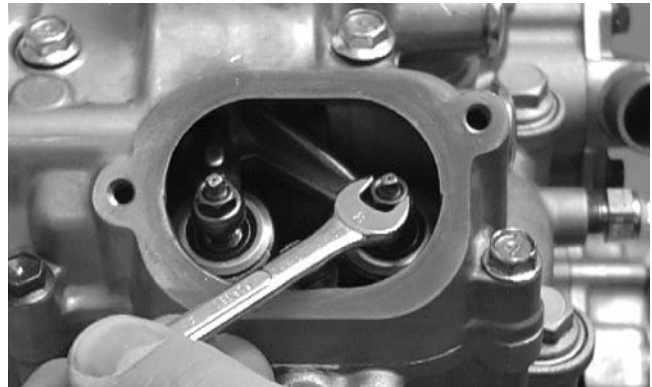

CC005D

26. Apply a thin coat of Three Bond Sealant to the mating surfaces of the cylinder head and valve cover.



CC275D

27. Place the valve cover into position.

■ **NOTE:** At this point, the rocker arms and adjuster screws must not have pressure on them.

28. Install the four top side cap screws with rubber washers; then install the remaining cap screws. Tighten only until snug.



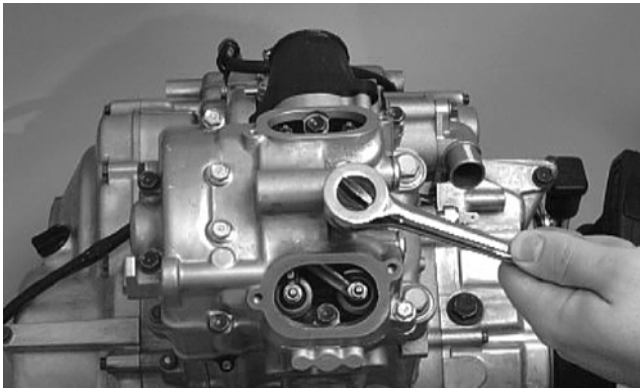

CC003D

29. In a crisscross pattern starting from the center and working outward, tighten the cap screws securely.

30. Adjust valve/tappet clearance using the following procedure.

■ **NOTE:** Use Valve Clearance Adjuster (p/n 0444-078) for this procedure.

A. Turn the engine over until the piston reaches top dead center on the compression stroke.

B. Place the valve adjuster onto the jam nut securing the tappet adjuster screw; then rotate the valve adjuster dial clockwise until the end is seated in the tappet adjuster screw.

C. While holding the valve adjuster dial in place, use the valve adjuster handle and loosen the jam nut; then rotate the tappet adjuster screw clockwise until friction is felt.

D. Align the valve adjuster handle with one of the marks on the valve adjuster dial.

E. While holding the valve adjuster handle in place, rotate the valve adjuster dial counter-clockwise until specified valve/tappet clearance is attained.

■ **NOTE:** Rotating the valve adjuster dial counter-clockwise will open the valve/tappet clearance by 0.05 mm (0.002 in.) per mark.

F. While holding the adjuster dial at the proper clearance setting, tighten the jam nut securely with the valve adjuster handle.

31. Place the two tappet covers into position making sure the proper cap screws are with the proper cover. Tighten the cap screws securely.

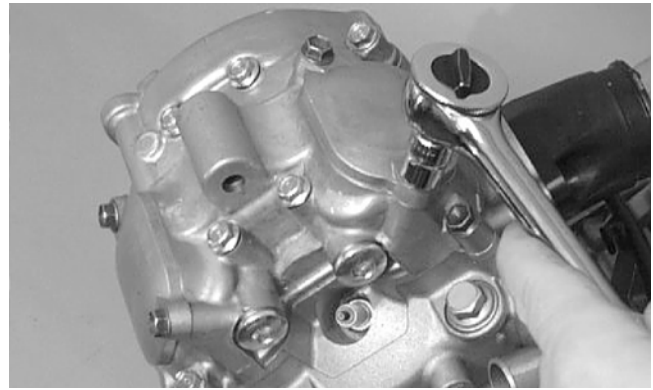

CC001D

32. If removed, install the spark plug. Tighten to specifications.

---

---

## Installing Engine/Transmission

---

---

3

■ **NOTE:** Arctic Cat recommends that new gaskets and O-rings be installed whenever servicing the vehicle.

1. Attach suitable lifting chains to the engine/transmission; then using an engine hoist, lower the assembly into the engine compartment.

### ⚠ WARNING

Keep hands and fingers clear when lowering the engine/transmission into place. The chains could shift causing severe injury.

### ⚠ CAUTION

Make sure that all wiring, hoses, and brake lines are routed away from engine mounts and engine brackets. Pinching or breaking of lines or shorting of wiring could occur.



PR114



■ **NOTE:** The rear engine mounting bracket and rear engine mounts should be attached to the engine. The front engine mounting bracket should be attached to the engine, and the front engine mounts should be in the frame.

2. Align the rear engine mount studs with the holes in the frame and slowly lower into place. The front engine mounting bracket will then slip over the engine mount studs.



PR146

3. Install the flange nuts on the rear engine mount studs; then secure the front engine mounting bracket to the front engine mount studs with two flange nuts. Tighten the four flange nuts to specifications.

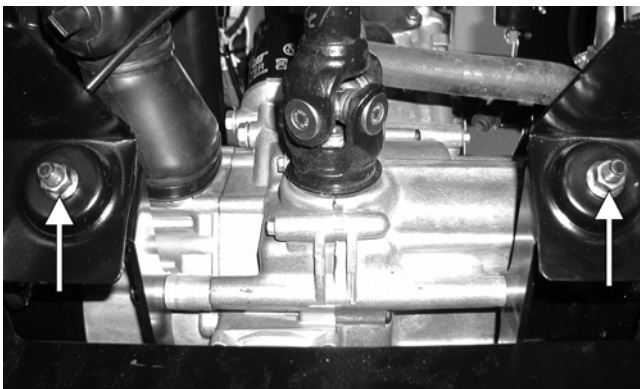

PR153A



PR147

4. Apply multi-purpose grease to the driveshaft splines; then align the flange marks and slide the splines into the slip-joints.



PR148

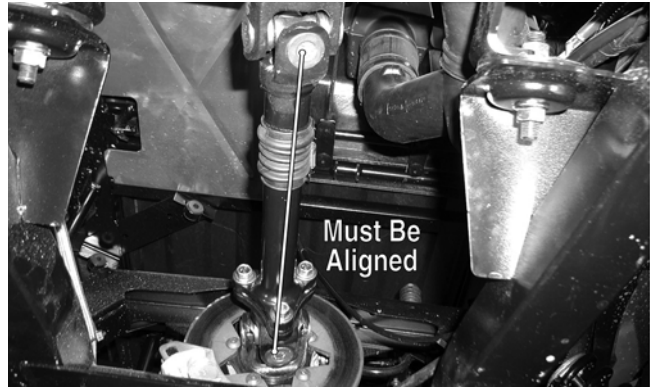

PR151A

**CAUTION**

The drive-line yokes must be aligned (timed) or damage will occur to the universal joints and gears.

5. Install the cap screws securing the drive-line couplers to the drive flanges and tighten to specifications.

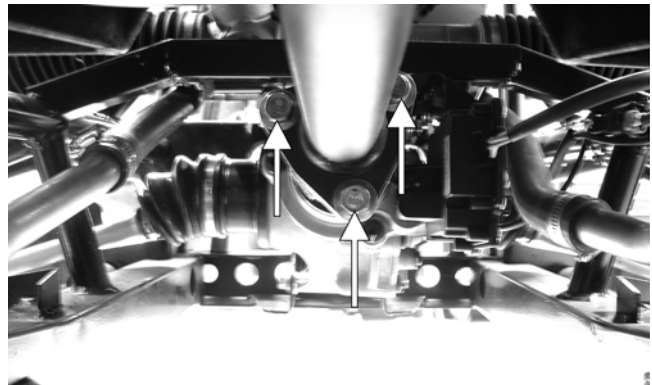

PR120A

6. Set the exhaust pipe in place; then install the muffler and align the assembly to the engine. Install two cap screws securing the exhaust pipe to the cylinder head and tighten to specifications.

7. Install the inlet boot on the V-belt housing; then install the exhaust duct connecting the outlet housing to the V-belt housing. Tighten all clamps securely.

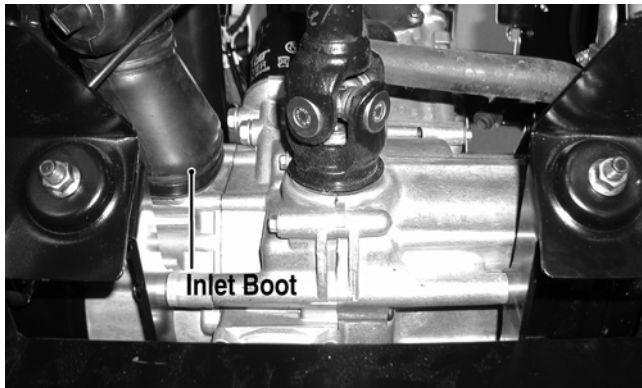

PR153B

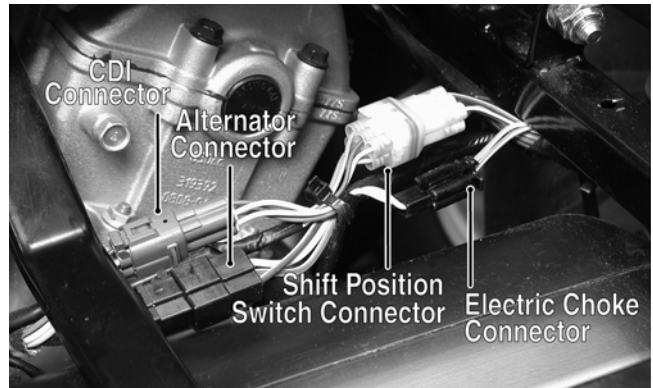

PR128A

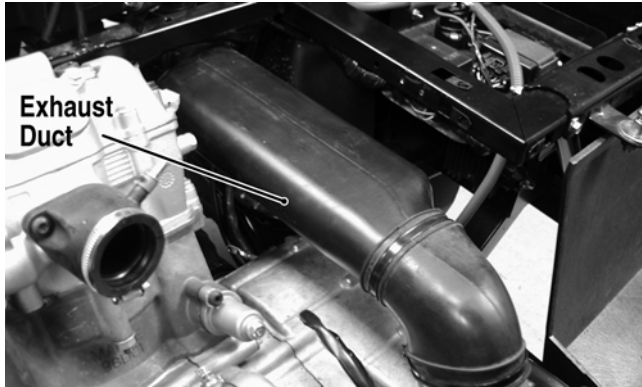

PR144B

10. From the left-side, connect the speed sensor connector (XT), fuel level sensor connector (XT), and temperature sensor lead; then install the spark plug cap.

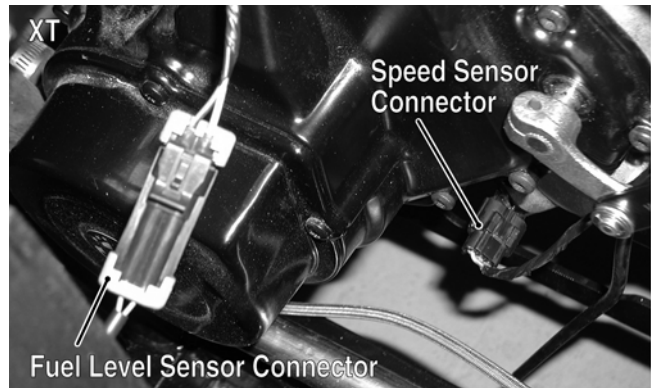

PR155B

8. Connect the lower coolant hose to the water pump housing; then connect the upper coolant hose to the thermostat housing. Tighten the hose clamps securely.

9. Install the starter wire on the starter and tighten the nut securely; then connect the CDI connector, alternator connector, shift position switch connector, and electric choke connector.

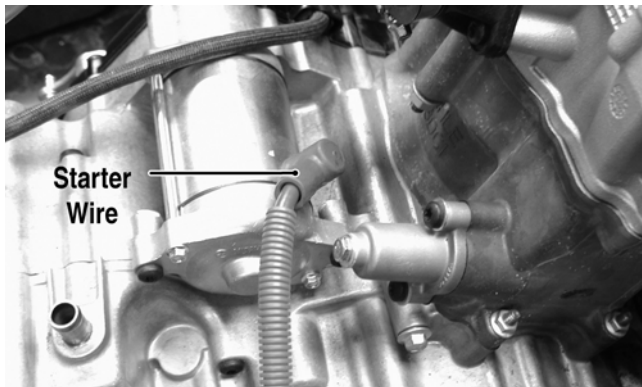

PR145A

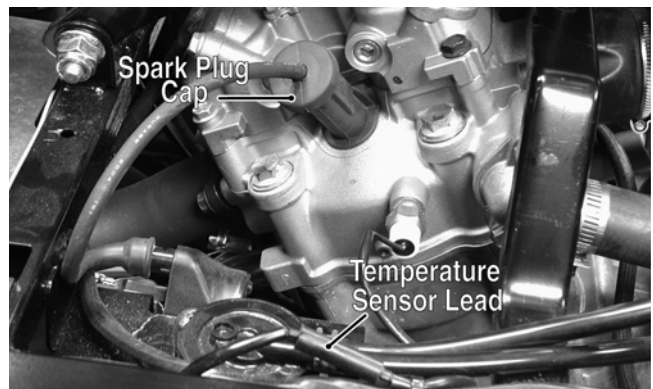

PR130A

■ **NOTE:** Make sure the main harness ground and battery ground wires are installed and secured in the proper location with the unpainted cap screw.



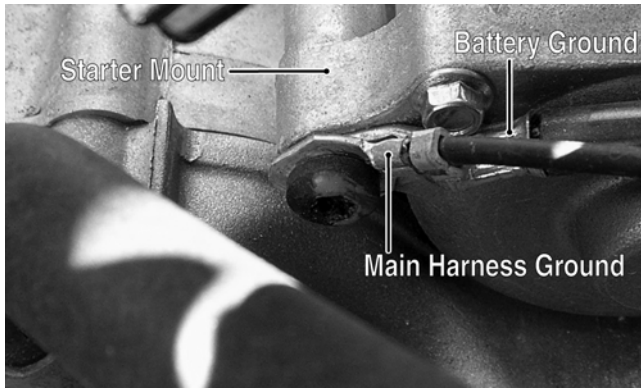

PR474A

11. Install the carburetor and tighten the intake boot clamp securely; then connect the gasoline hose, vacuum line, and throttle cable.

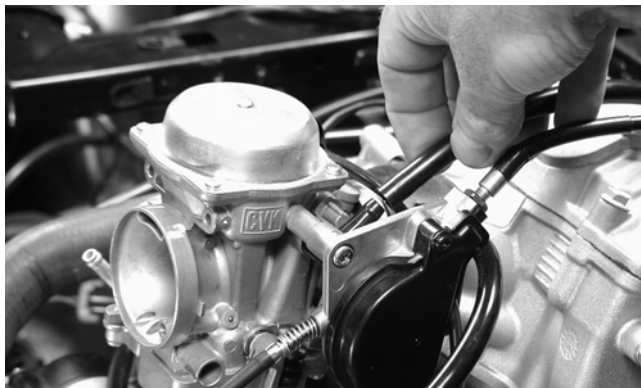

PR117



PR140B

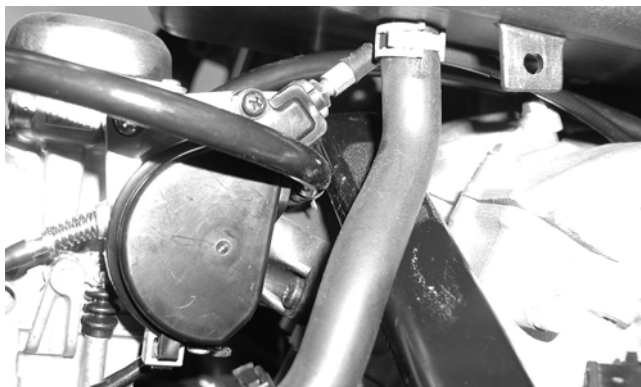

PR154

12. Place the air filter assembly into position and secure with the self-tapping screws; then connect the intake boot to the carburetor and the inlet housing boot to the air filter housing. Tighten the clamps securely.



PR127A

13. Place the shifter assembly into position and secure with the four machine screws. Tighten securely.

14. Connect the shifter linkage to the transmission shift arm placing the washer and bushing in appropriate locations; then secure with the E-clip.

■ **NOTE:** Before operating vehicle, check and adjust shifter linkage as required (see Section 2).

15. Fill the engine/transmission with the appropriate lubricant.

16. Fill the cooling system with the appropriate coolant.

17. Connect the positive battery cable to the battery; then connect the negative cable.

18. Install the left-side and right-side seat-bases; then install the center console and seats. Make sure the seats lock securely.

19. Start the engine and warm up to operating temperature. Check for fluid leaks; then shut off engine and check oil and coolant levels (see Section 2).



# SECTION 4 - FUEL/LUBRICATION/COOLING

4

---

---

## TABLE OF CONTENTS

---

Carburetor Specifications .....	4-2
Carburetor Schematic .....	4-2
Carburetor .....	4-2
Engine RPM (Idle) .....	4-6
Gas Tank .....	4-6
Gas/Vent Hoses .....	4-9
Vacuum Pulse Fuel Pump .....	4-9
Oil Flow Chart .....	4-10
Oil Filter/Oil Pump .....	4-10
Oil Cooler .....	4-11
Liquid Cooling System.....	4-13
Radiator/Oil Cooler.....	4-13
Thermostat .....	4-15
Fan .....	4-16
Water Pump .....	4-16
Vacuum Pulse Fuel Pump .....	4-17
Fuel Level Sensor (XT).....	4-17

## Carburetor Specifications

PROWLER/XT	
Type	Keihin CVK36
Main Jet	132
Slow Jet	40
Pilot Screw Setting (turns)	1 1/4
Needle Jet	6.0/4.0
Jet Needle	Fixed
Idle RPM	1250-1350
Starter Jet	85
Float Arm Height	17 mm (0.7 in.)

## Carburetor Schematic

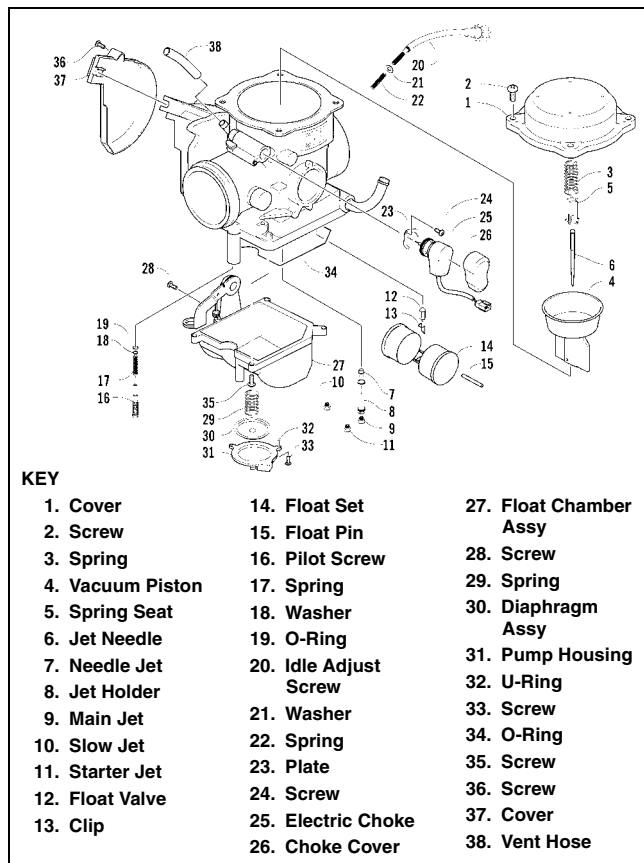

0741-115

## Carburetor

### ⚠ WARNING

Whenever any maintenance or inspection is performed on the fuel system during which there may be fuel leakage, there should be no welding, smoking, open flames, etc., in the area.

### REMOVING

1. Remove the seats and center console; then remove the left-side seat-base.
2. Loosen the clamps on the inlet boot; then remove the boot from the left-side.

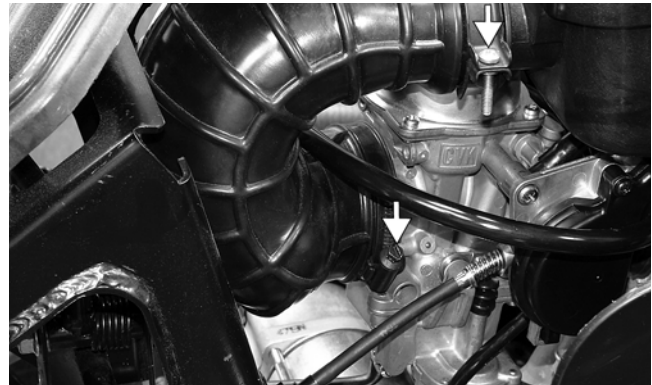

PR160A

3. Loosen the clamp securing the intake boot to the carburetor; then separate the carburetor from the boot.
4. Remove the gas hose and carburetor float chamber vent hose.
5. Remove the throttle arm cover; then loosen the outer jam nut on the throttle cable and disconnect the throttle cable from the carburetor.

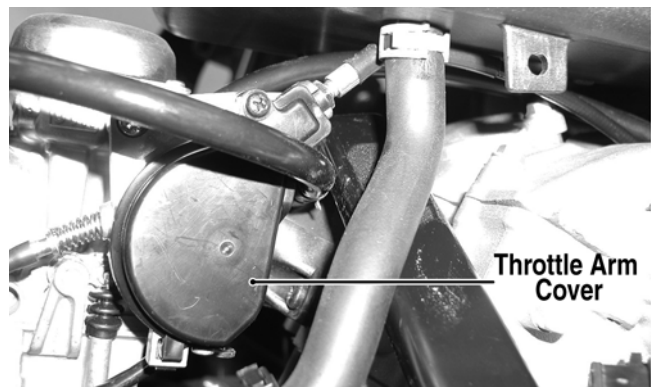

PR154A

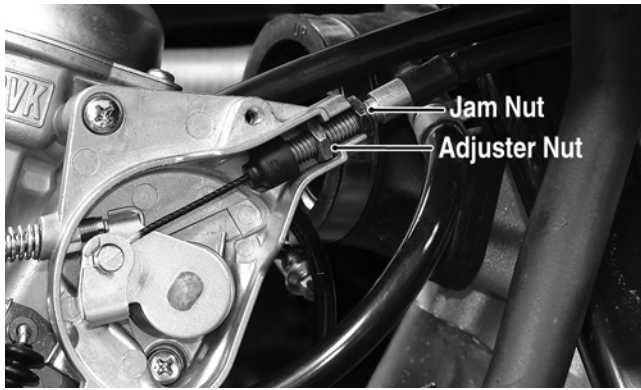

6. Disconnect the electric choke connector; then remove the carburetor from the engine.

### DISASSEMBLING

1. Remove the four Phillips-head screws securing the top cover; then remove the cover.

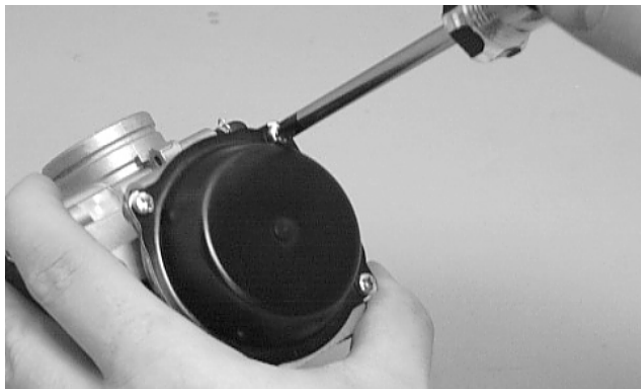

2. Remove the vacuum piston assembly from the carburetor body. Account for a spring, spring seat, and the jet needle.

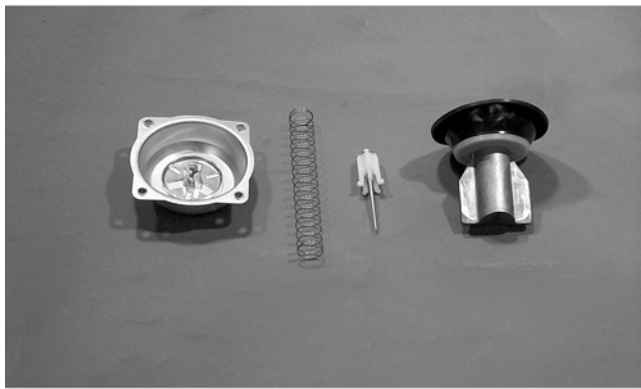

3. Remove the three screws securing the pump housing. Account for the diaphragm assembly, spring, and U-ring (in the housing).

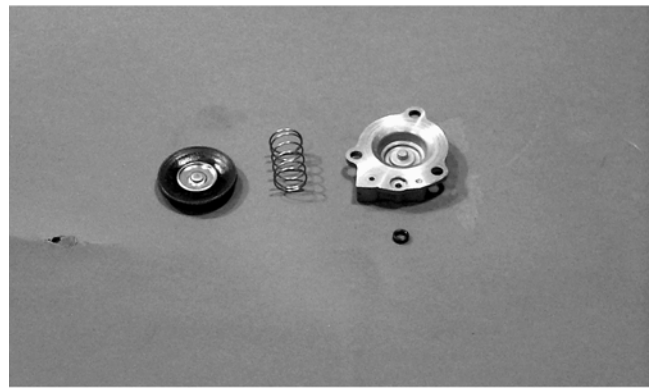

4. Remove the Phillips-head screws securing the float chamber; then remove the chamber. Account for the O-ring.

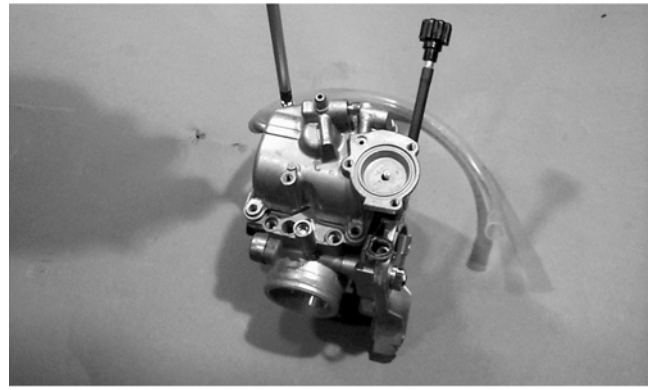

4

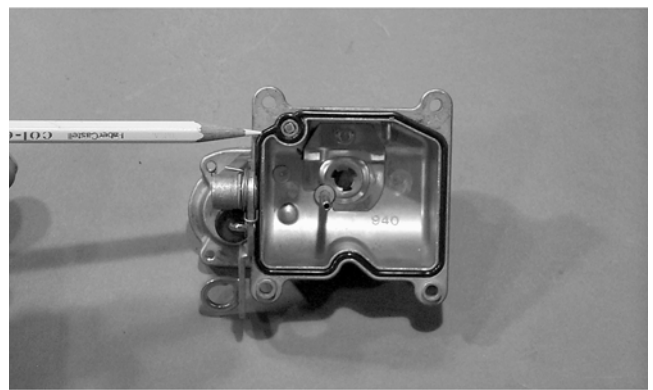

5. Remove the float pin.

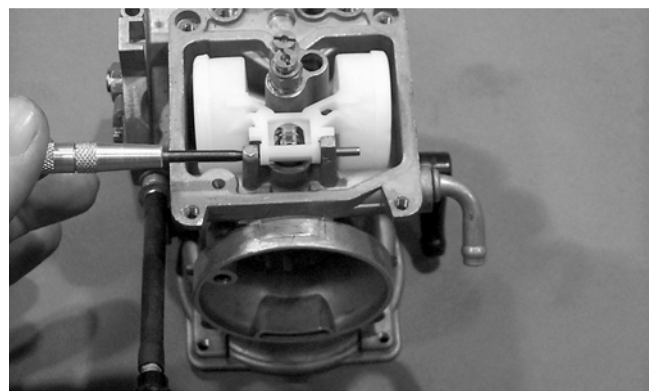



- Lift the float assembly from the carburetor. Account for the float valve.

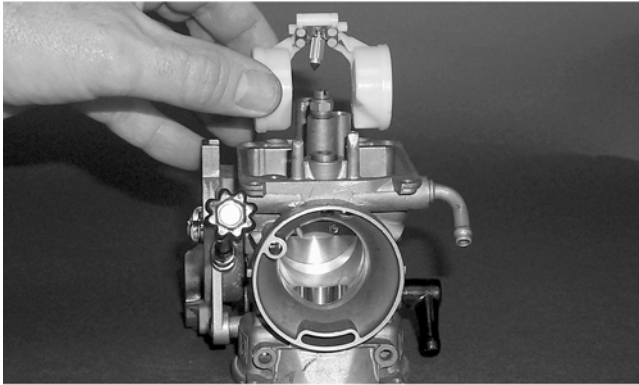

CC753

■ **NOTE:** Note the locations of the jets, pilot screw, and holder for disassembling procedures.

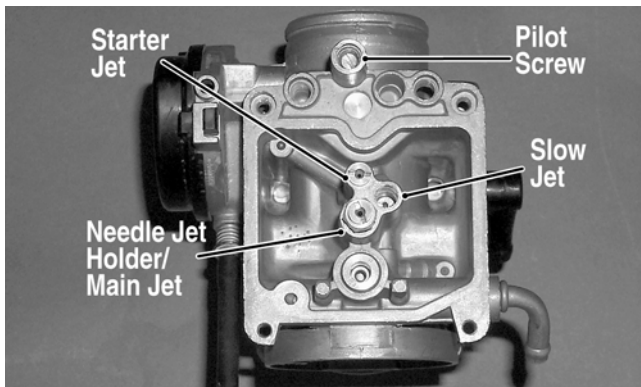

CC761A

- Secure the needle jet holder with a wrench; then remove the main jet.
- Remove the needle jet holder; then remove the needle jet, slow jet, and the starter jet.
- Remove the pilot screw. Account for a spring, a washer, and an O-ring.

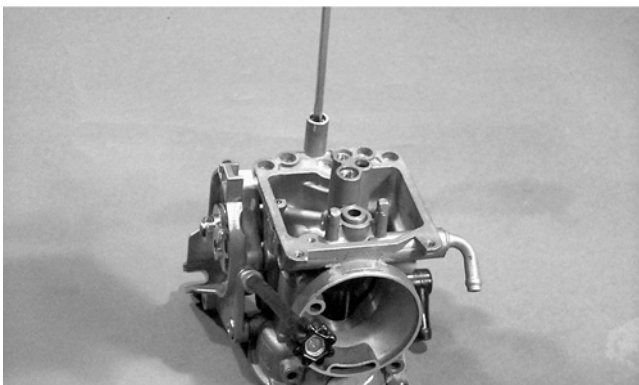

CC758

- Unscrew and remove the idle adjust screw assembly. Account for the spring and washer.

## CLEANING AND INSPECTING

■ **NOTE:** Whenever a part is worn excessively, cracked, or damaged in any way, replacement is necessary.

### ⚠ WARNING

When drying components with compressed air, always wear safety glasses.

### ⚠ CAUTION

DO NOT place any non-metallic components in parts-cleaning solvent because damage or deterioration will result.

- Place all metallic components in a wire basket and submerge in carburetor cleaner.
  - Soak for 30 minutes; then rinse with fresh parts-cleaning solvent.
  - Wash all non-metallic components with soap and water. Rinse thoroughly.
  - Dry all components with compressed air only making sure all holes, orifices, and channels are unobstructed.
  - Inspect the carburetor body for cracks, nicks, stripped threads, and any other imperfections in the casting.
  - Inspect the vacuum piston/diaphragm for cracks, imperfections in the casting, or cracks and tears in the rubber.
  - Inspect float for damage.
  - Inspect gasket and O-rings for distortion, tears, or noticeable damage.
  - Inspect tips of the jet needle, pilot screw, and the needle jet for wear, damage, or distortion.
  - Inspect the slow jet and main jet for obstructions or damage.
- **NOTE:** If the slow jet is obstructed, the mixture will be extremely lean at idle and part-throttle operation.
- Inspect the float valve for wear or damage.
  - Inspect the carburetor mounting flange for damage and tightness.

## ASSEMBLING

1. Thread the idle adjust screw assembly into the carburetor making sure the washer and spring are properly positioned.
2. Install the pilot screw with the spring, the washer, and the O-ring in this order.

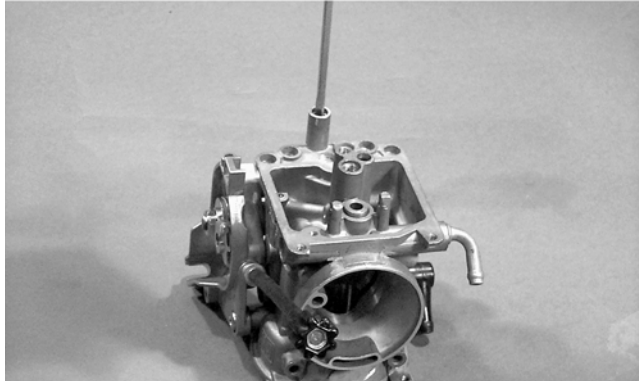

CC758

■ **NOTE:** Turn the pilot screw clockwise until it is lightly seated; then turn it counterclockwise the recommended number of turns as an initial setting.

■ **NOTE:** Note the locations of the jets and holder during assembling procedures.

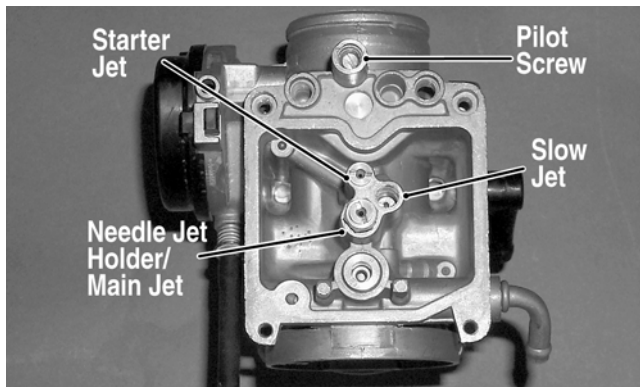

CC761A

3. Install the slow jet. Tighten securely.
4. Install the main jet into the needle jet holder and tighten securely; then install the needle jet and needle jet holder assembly into the carburetor and tighten securely.
5. Place the float assembly (with float valve) into position and secure to the carburetor with the float pin.

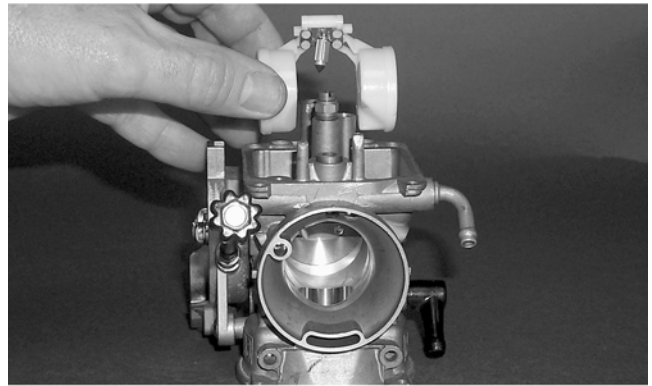

CC753

■ **NOTE:** Check float arm height by placing the carburetor on its side w/float contacting the needle; then measure with a caliper the height when the float arm is in contact with the needle valve. Float arm height should be 17 mm (0.7 in.).

6. Place the float chamber into position making sure the O-ring is properly positioned; then secure with the Phillips-head screws.

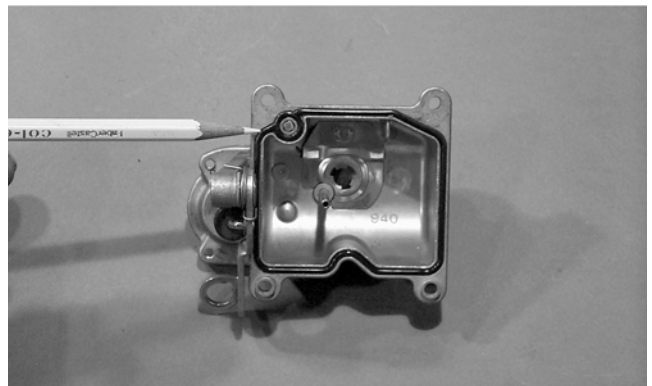

CC750

4

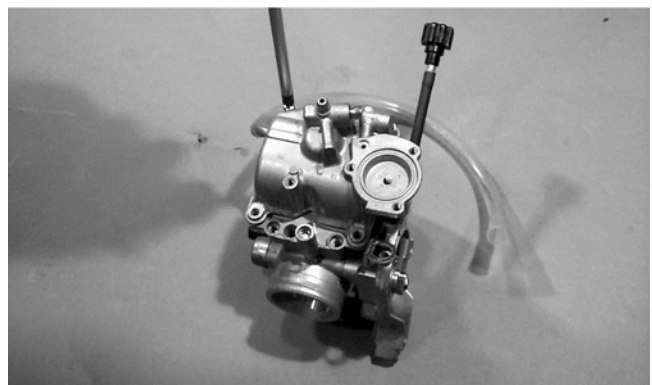

CC749

7. Place the U-ring into the pump housing. Position the spring and diaphragm assembly (lip toward the carburetor) onto the carburetor; then secure the assembly with the pump housing and three screws. Tighten securely.

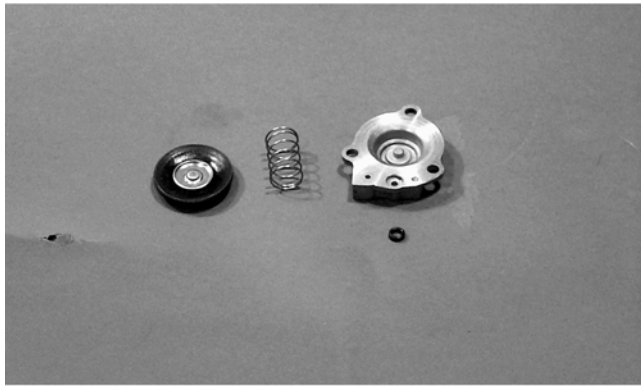

CC748

**⚠ CAUTION**

It is important to press down on the pump housing until it contacts the carburetor to make sure the diaphragm lip is properly seated in the groove in the carburetor. If the diaphragm is not properly seated, leakage will occur.

8. Place the jet needle, spring seat, and spring into the vacuum piston; then place the assembly down into the carburetor.

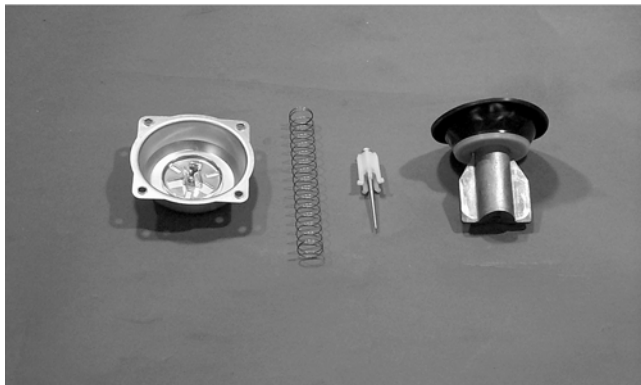

CC746

9. Place the top cover into position; then secure with the Phillips-head screws. Tighten securely.

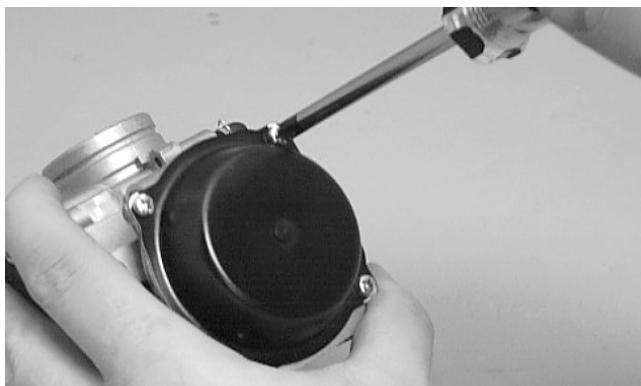

CH015D

## INSTALLING

1. Place the carburetor into position on the engine; then connect the electric choke connector to the main harness.
2. Connect the throttle cable to the carburetor. Tighten the jam nut securely.
3. Connect the gas hose; then connect the carburetor float chamber vent hose.
4. Place the carburetor into the intake boot and tighten the clamp securely.
5. Install the inlet boot between the air filter housing and the carburetor; then tighten the clamps securely.
6. Install the left-side seat-base; then install the center console and the seats making sure the seats lock securely.

---

---

## Engine RPM (Idle)

---

---

To adjust idle RPM, see Section 2.

---

---

## Gas Tank

---

---

**⚠ WARNING**

Whenever any maintenance or inspection is made on the fuel system during which there may be fuel leakage, there should be no welding, smoking, open flames, etc., in the area.

## REMOVING

1. Remove the seats and center console; then remove the left-side and right-side seat-bases.
2. Remove twelve cap screws and two self-tapping screws securing the floorboard to the frame.
3. While pulling forward on the upper portion of the floorboard, lift the rear panel above the seat lock studs; then insert a small wood block to hold in position.



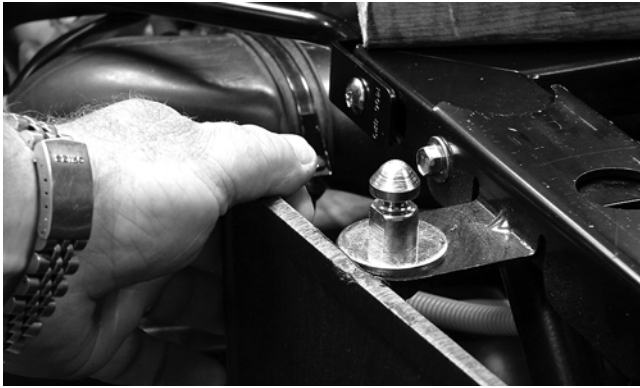

PR163

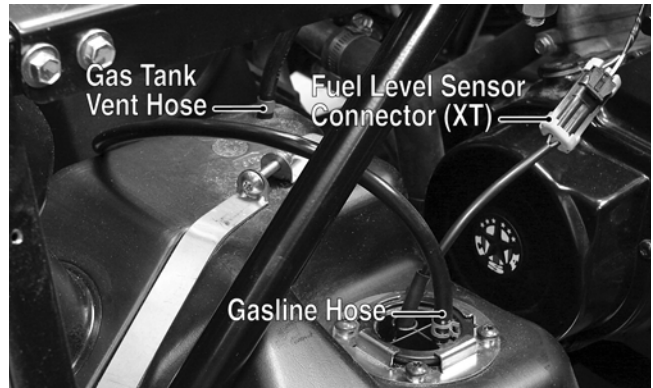

PR166D



PR164

4. From the opposite side of the vehicle, repeat step 3; then lift the rear of the floorboard up and lift the floorboard out of the vehicle.

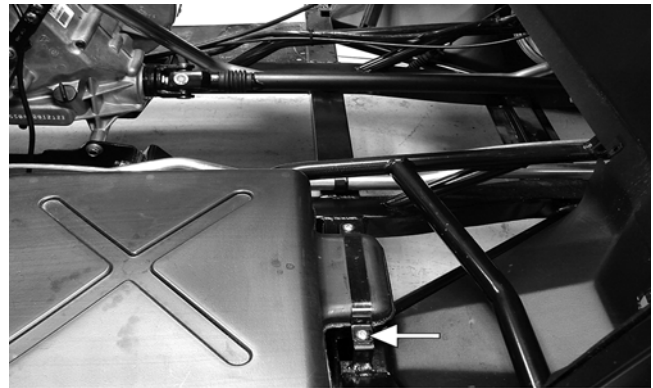

PR167A

4

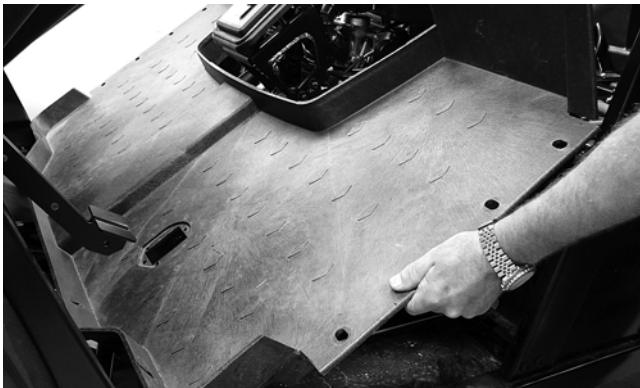

PR165

5. Disconnect the vent hose, gasline hose, and fuel level sensor connector (XT); then cap the vent fitting and gas hose fitting.



PR170

7. Remove four press-nuts securing the gas cap inset; then remove the gas cap and inset. Install the gas cap.



PR168

8. Remove the joining cap screw and nut from the rear gas tank hold-down strap; then remove the inside hold-down strap.



PR172A

9. Lift and slide the tank forward raising the front of the tank first; then turn the tank and lift out the right side.

## CLEANING AND INSPECTING

■ **NOTE:** Whenever a part is worn excessively, cracked, or damaged in any way, replacement is necessary.

1. Clean all gas tank components with parts-cleaning solvent.
2. Inspect all hoses for cracks or leaks.
3. Inspect gas tank cap and tank for leaks, holes, and damaged threads.
4. On the XT, inspect the fuel level sensor for proper operation (see Fuel Level Sensor (XT) in this section).

## INSTALLING

### ⚠ WARNING

Whenever any maintenance or inspection is made on the fuel system during which there may be fuel leakage, there should be no welding, smoking, open flames, etc., in the area.

1. Place the gas tank into position in the vehicle; then install the inside rear hold-down strap.



PR173



PR172A

2. Swing the front hold-down to the right into position and install the cap screw and nut. Do not tighten at this time.



PR171

3. Install the rear hold-down strap joining cap screw and nut. Do not tighten at this time.



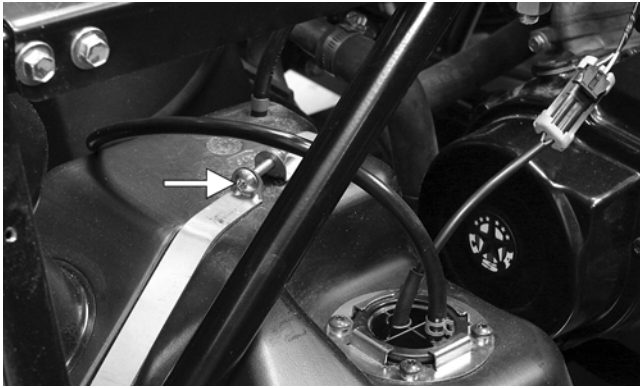

PR166A

4. Place the gas cap filler panel into position; then if necessary, position the gas tank so the filler panel and filler neck are not binding or rubbing.

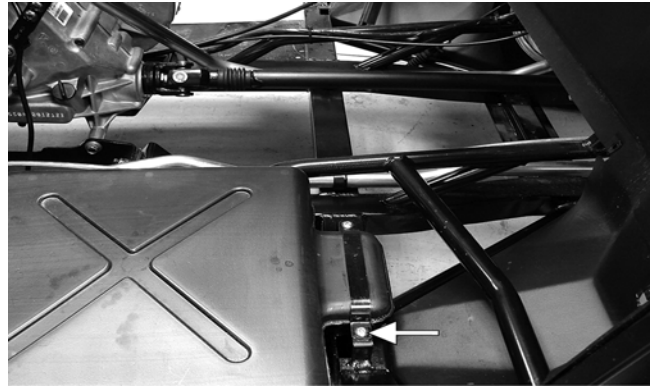

PR167A

6. Connect the gasoline hose and gas tank vent hose to the proper fittings; then connect the fuel level sensor connector (XT) to the main harness.



PR176

5. Secure the filler panel with four press-nuts; then tighten the hardware securing the hold-down straps (from steps 2-3) securely.

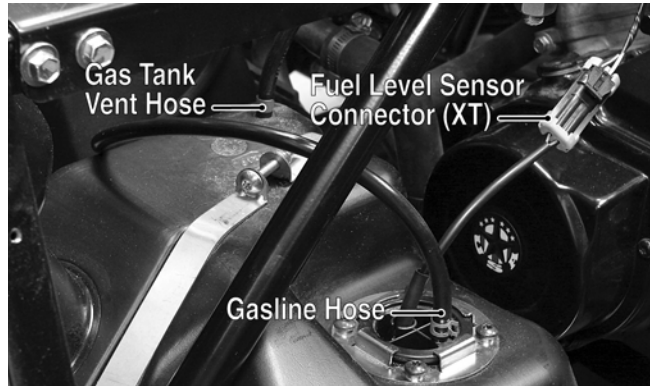

PR166D

7. Position the floorboard into the vehicle and secure with the appropriate hardware; then install the center console, seat-bases, and seats making sure the seats lock securely.

4

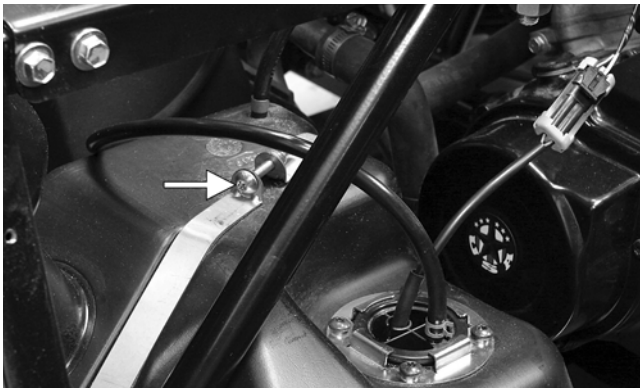

PR166A

---

---

## Gas/Vent Hoses

---

---

Replace the gas hose every two years. Damage from aging may not always be visible. Do not bend or obstruct the routing of the carburetor vent hose. Make certain that the vent hose is securely connected to the carburetor and the opposite end is always open.

---

---

## Vacuum Pulse Fuel Pump

---

---

The vacuum pulse fuel pump is a nonserviceable assembly. If the pump fails, it must be replaced.



## Oil Flow Chart

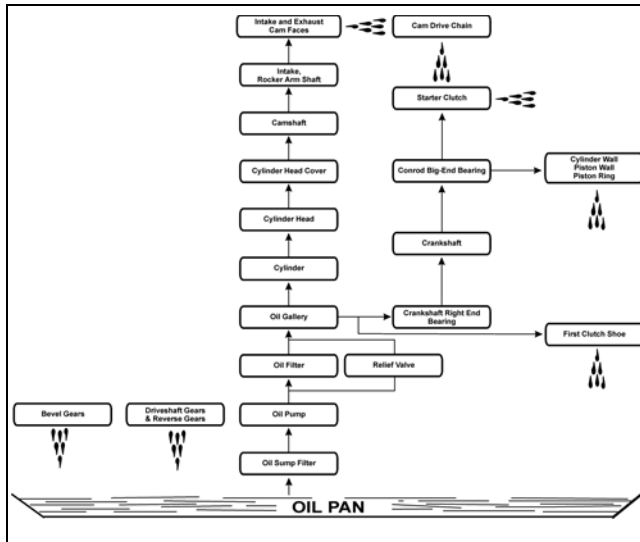

ATV-1102

## Oil Filter/Oil Pump

■ **NOTE:** Whenever internal engine components wear excessively or break and whenever oil is contaminated, the oil pump should be disassembled, cleaned and inspected, and serviced as necessary.

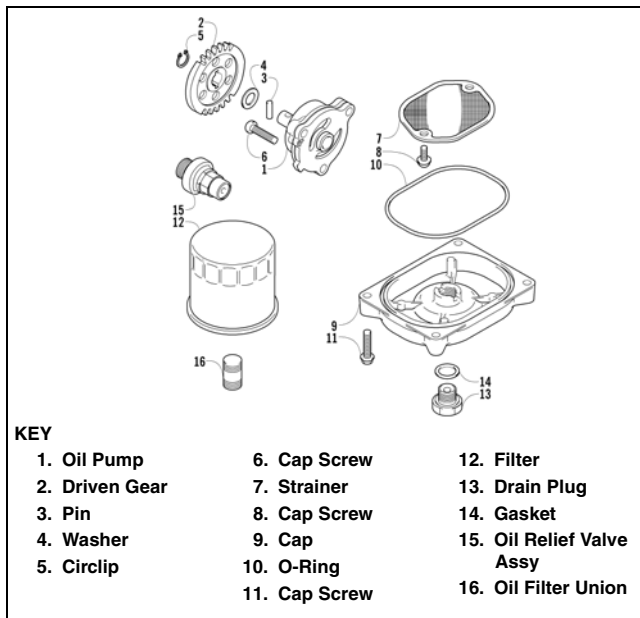

0738-289

## TESTING OIL PUMP PRESSURE

■ **NOTE:** The engine must be warmed up to the specified temperature for this test.

1. Remove the seats and center console; then remove the left-side seat-base.
2. Tilt the cargo box back.
3. Loosen the clamps securing the V-belt housing exhaust duct; then remove the duct and set aside.

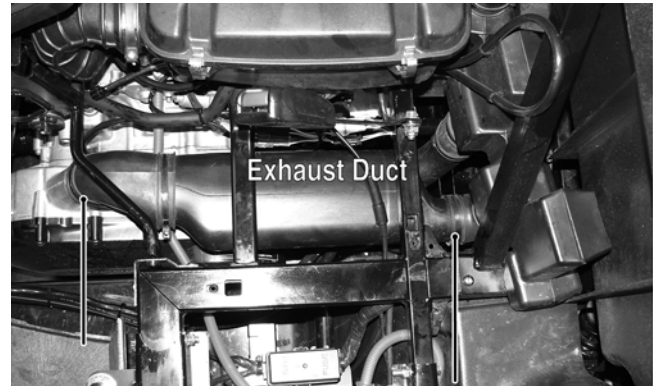

PR266A

4. Disconnect the upper oil cooler hose; then using an appropriate T-fitting and adapter, connect the Oil Pressure Test Kit (p/n 0644-495) into the oil cooler circuit.

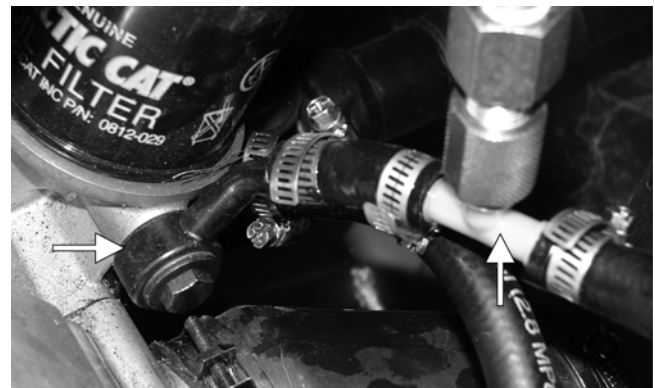

PR265A

■ **NOTE:** Some oil seepage may occur when installing the oil pressure gauge. Wipe up oil residue with a cloth.

5. Set the parking brake and start the engine. Allow the engine to warm up to operating temperature (with cooling fan cycling).
6. Set the speedometer/tachometer to RPM (XT) or connect a suitable tachometer (Prowler). With the engine running at 2500 RPM, the pressure gauge must show 1.40-2.11 kg/cm<sup>2</sup> (20-30 psi).
7. Reconnect the oil cooler hose and tighten the hose clamp securely; then install the V-belt exhaust duct and tighten the clamps securely.

8. Install the left-side seat-base; then install the center console and seats making sure the seats lock securely.

■ **NOTE:** If the oil pressure is lower than specified, check for an oil leak, damaged oil seal, defective oil pump, or plugged oil cooler (see Checking Oil Cooler Restriction in the Oil Cooler sub-section).

■ **NOTE:** If the oil pressure is higher than specified, check for too heavy engine oil weight (see Section 2), clogged oil passage, clogged oil filter, or improper installation of the oil filter.

## REMOVING/DISASSEMBLING

■ **NOTE:** Prior to removing the oil pump due to a low oil pressure reading, check for oil cooler restrictions (see Checking Oil Cooler Restriction in the Oil Cooler sub-section).

1. Remove the oil pump from the engine (see Right-Side Components in Section 3).
2. Remove the Phillips-head screw on the back side of the pump and separate the pump housing and cover. Note the position of the inner and outer rotors and alignment pin for assembly.
3. Remove oil pump components.

## CLEANING AND INSPECTING

■ **NOTE:** Whenever a part is worn excessively, cracked, or damaged in any way, replacement is necessary.

1. Clean all oil-pump components.
2. Inspect the rotors for scoring and gouges.
3. Inspect the alignment pin, driveshaft, and driven sprocket for damage.
4. Inspect the pump housing and cover for cracks or damage.

## ASSEMBLING/INSTALLING

1. Place the rotors into the pump housing making sure the alignment pin is in the groove of the rotor.
2. Place the cover onto the pump housing.
3. Secure the pump with the Phillips-head screw coated with red Loctite #271.
4. Install the oil pump into the engine (see Right-Side Components in Section 3).

# Oil Cooler

## CHECKING OIL COOLER RESTRICTION

1. Remove the seats, center console, and left-side seat-base; then remove the V-belt exhaust duct. Tilt the cargo box back.
2. Disconnect the lower oil cooler hose; then using an appropriate T-fitting and adapter, connect the Oil Pressure Test Kit (p/n 0644-495) into the oil cooler circuit.

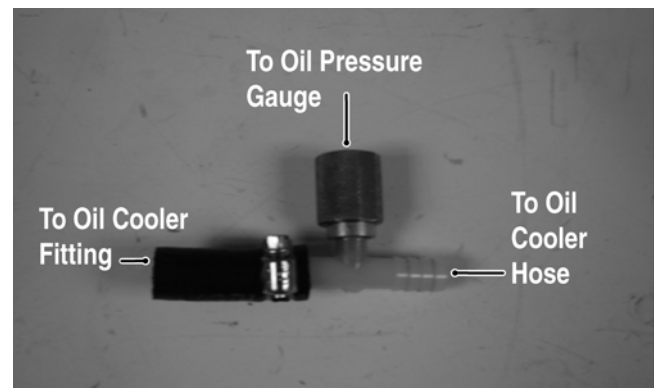

PR267A

3. Set the parking brake and start the engine. Allow the engine to warm up to operating temperature (with cooling fan cycling).
4. Set the speedometer/tachometer to RPM (XT) or connect a suitable tachometer (Prowler). With the engine running at 2500 RPM, the pressure gauge must show 4.2-5.6 kg/cm<sup>2</sup> (60-80 psi).

■ **NOTE:** If the gauge readings are normal but low oil pressure was noted while testing the oil pump pressure, the oil cooler is plugged and must be replaced.

## REMOVING OIL COOLER

■ **NOTE:** The oil cooler is attached to the rear of the radiator and must be removed as an assembly (see Radiator/Oil Cooler sub-section).

1. Disconnect the two-wire connector on the cooling fan harness; then remove the machine screw and wire clamp securing the cooling fan switch wires.

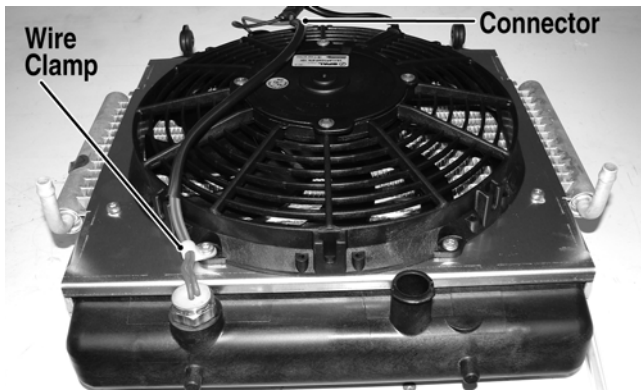

PR271A

2. Remove four machine screws (two on each side) securing the fan shroud to the radiator noting orientation of the fan and oil cooler for assembling.



PR275A

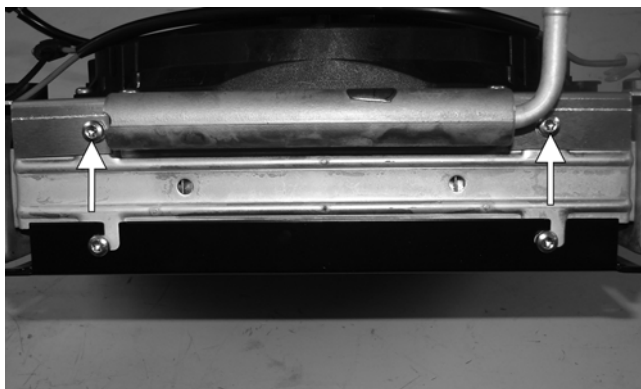

PR268A

3. Remove four machine screws securing the oil cooler to the fan shroud and remove the oil cooler.

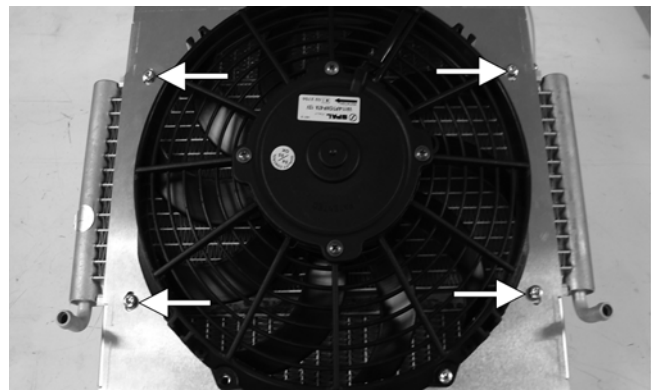

PR273A

## INSTALLING OIL COOLER

1. Place the oil cooler on a clean flat surface; then position the fan shroud over the oil cooler making sure the fan wires are directed toward the top of the shroud and the oil cooler connections are directed toward the bottom of the shroud. Secure with four machine screws.

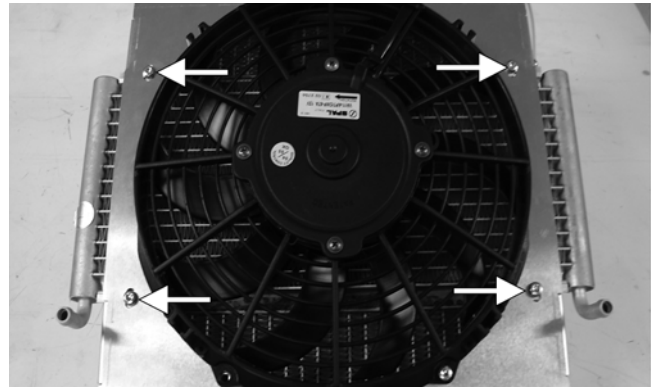

PR273A

2. Place the radiator on a flat surface (front side down); then position the oil cooler/cooling fan assembly onto the radiator with the oil cooler connections directed toward the bottom of the radiator. Secure with four machine screws making sure to install the radiator overflow hose hold-down clip on the upper-right machine screw.

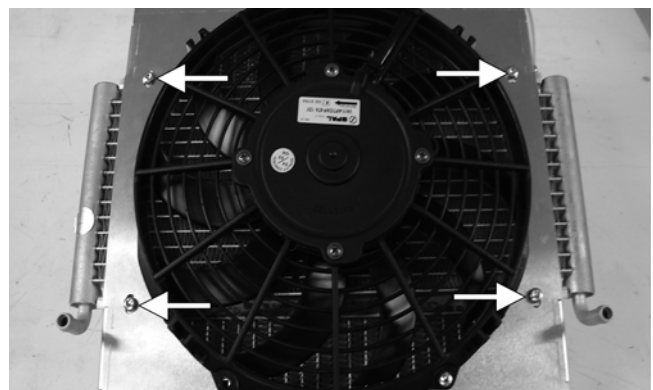

PR273A

3. Connect the cooling fan harness to the cooling fan connector; then secure the cooling fan harness wire clamp with the machine screw.



## Liquid Cooling System

The cooling system should be inspected daily for leakage and damage. Also, the coolant level should be checked periodically.

When filling the cooling system, use premixed Arctic Cat Antifreeze. While the cooling system is being filled, air pockets may develop; therefore, run the engine for five minutes after the initial fill, shut the engine off, and then fill the cooling system to the bottom of the stand pipe in the radiator neck.

### ⚠ CAUTION

After operating the vehicle for the initial 5-10 minutes, stop the engine, allow the engine to cool down, and check the coolant level. Add coolant as necessary.

## Radiator/Oil Cooler

### REMOVING

1. Remove six torx-head screws securing the dash assembly to the frame and one cap screw and nut from the center support. Slide the dash rearward approximately four inches.

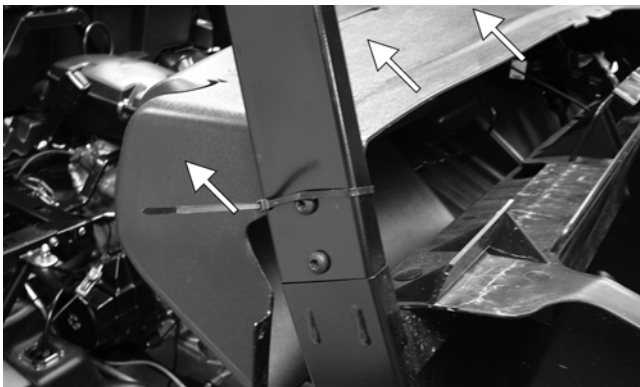

PR181A

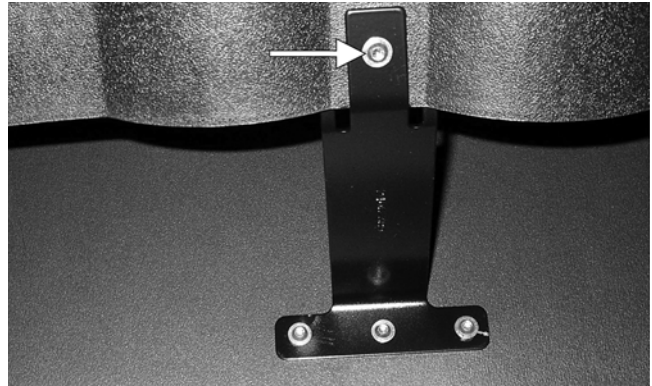

PR475A

2. Remove four torx-head screws (A) securing the under-hood storage box to the frame; then remove two cap screws with nuts (B) at the front of the storage box.

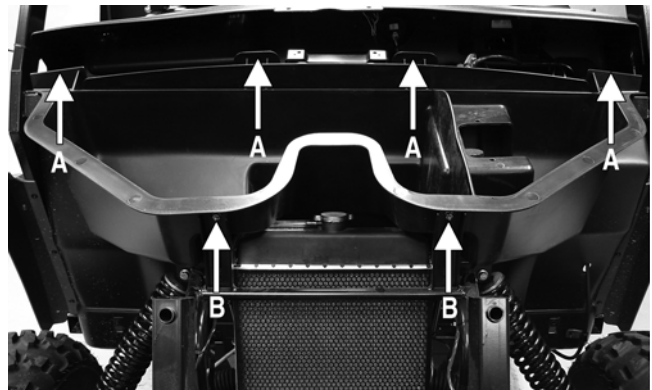

PR182A

3. While lifting up on the front of the storage box, pry the rear center clear of the center dash mount and remove the storage box.



PR186

4. Drain the coolant into a suitable container; then disconnect the cooling fan wire connector from the main harness.

4

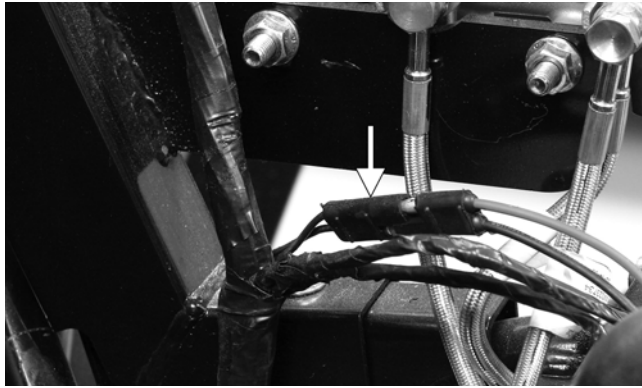

PR183A

5. Remove the two shoulder bolts and nuts securing the radiator to the frame; then disconnect the upper and lower coolant hoses.

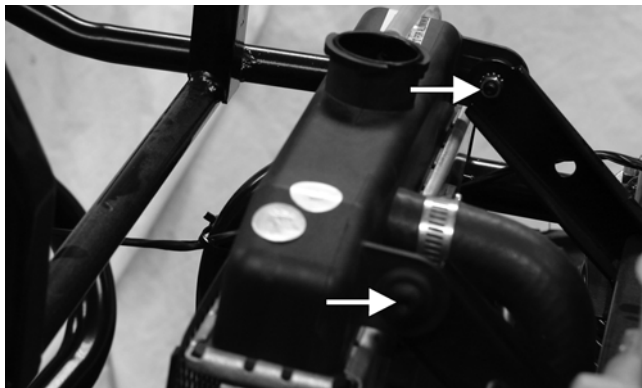

PR184A

6. Place a shallow container under the right-side oil cooler hose; then remove the hose from the oil cooler.



PR185

7. Allow the oil cooler to drain; then remove the left-side oil cooler hose.
8. Lift the radiator/oil cooler assembly from the vehicle. Account for two upper and two lower rubber mounting grommets.

## CLEANING AND INSPECTING

■ **NOTE:** Whenever a part is worn excessively, cracked, or damaged in any way, replacement is necessary.

1. Flush the radiator with water to remove any contaminants.
2. Inspect the radiator for leaks and damage.
3. Inspect all hoses for cracks and deterioration.
4. Inspect all fasteners and grommets for damage or wear.

## INSTALLING

1. Place the radiator/oil cooler into position making sure the grommets are correctly installed; then secure to the mounts with the two shoulder bolts and nuts. Tighten securely.

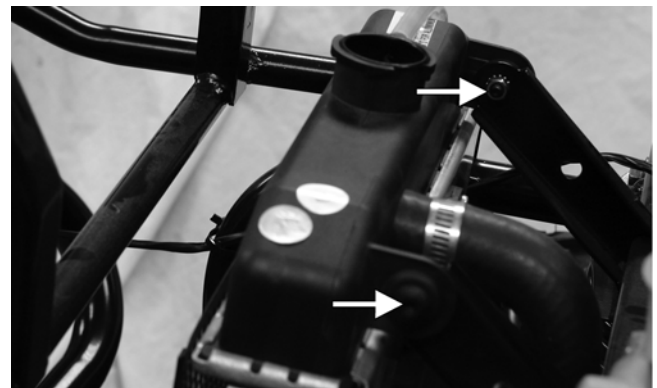

PR184A

2. Connect the upper and lower radiator hoses and the left and right oil cooler hoses to the radiator/oil cooler and secure with the appropriate hose clamps; then connect the cooling fan connector to the main harness.

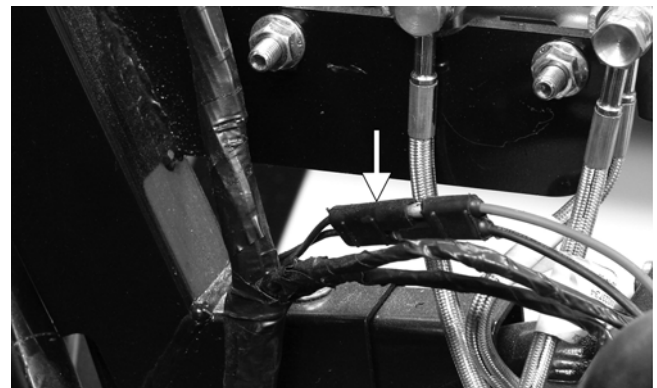

PR183A

3. Pour the recommended coolant into the radiator and secure the radiator cap.

- Place the storage box into position and using a smooth, flat pry-bar, pry the center of the box past the dash mount; then secure with the appropriate fasteners.



PR187

- Slide the dash forward into position; then secure the dash with the appropriate hardware.
- Install the jam nut and parking brake release handle; then tighten the jam nut so the handle is correctly oriented.
- Set the parking brake; then start the engine and let idle for approximately one minute to fill the oil cooler. Shut the engine off and add oil to the crankcase as required to the specified level (see Section 2).



PR053B

- Start the engine and warm up to operating temperature; then check that the coolant level is at the specified level (see Section 2). Add coolant as required.

## Thermostat

### REMOVING

- Drain approximately one quart of coolant from the cooling system.

- Remove the two cap screws securing the thermostat housing to the cylinder head. Account for a thermostat with seal.

### INSPECTING

■ **NOTE:** Whenever a part is worn excessively, cracked, or damaged in any way, replacement is necessary.

- Inspect the thermostat for corrosion, wear, or spring damage.
- Using the following procedure, inspect the thermostat for proper operation.
  - Suspend the thermostat in a container filled with water.
  - Heat the water and monitor the temperature with a thermometer.
  - The thermostat should start to open at 73.5-76.5°C (164-170°F).
  - If the thermostat does not open, it must be replaced.
- Inspect all coolant hoses, connections, and clamps for deterioration, cracks, and wear.

■ **NOTE:** All coolant hoses and clamps should be replaced every four years or 4000 miles.

### INSTALLING

- Place the thermostat into the thermostat housing; then secure the thermostat housing to the cylinder head with the two cap screws.

#### CAUTION

When installing the thermostat, make sure the bleed holes are straight up and down or air will remain trapped causing engine damage due to overheating.

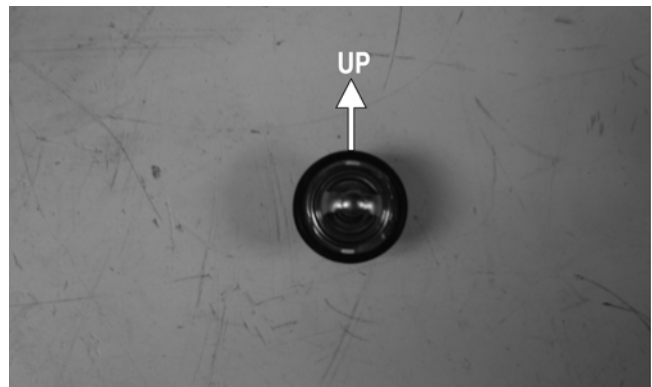

PR281A

- Fill the cooling system with the recommended amount of antifreeze. Check for leakage.

4



---

---

## Fan

---

### REMOVING

1. Remove the radiator (see Radiator/Oil Cooler in this section).
2. Remove the fan assembly from the radiator.

### INSTALLING

1. Position the fan assembly on the radiator; then secure with existing hardware.

■ **NOTE:** The fan wiring must be in the upper-right position.

2. Install the radiator (see Radiator/Oil Cooler in this section).

---

---

## Water Pump

---

■ **NOTE:** The water pump is not a serviceable component. If the pump is defective or if the mechanical seal is leaking (coolant dripping from the discharge hole), the water pump must be replaced.

### REMOVING

1. Remove the radiator cap; then remove the water pump coolant drain plug and drain the coolant.

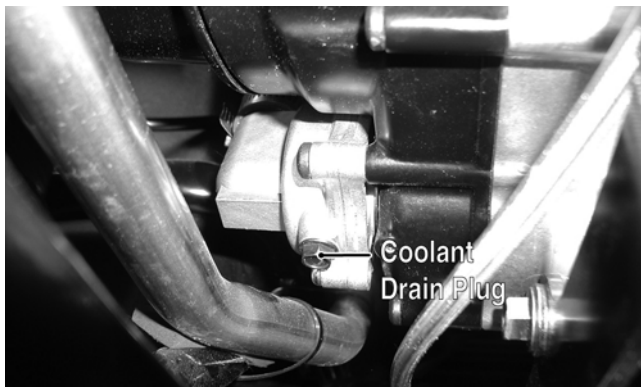

2. Drain the oil from the engine/transmission.
3. Remove the seats and center console; then remove the right-side seat-base.
4. Loosen the coolant hose clamps and slide the clamps away from the hose ends approximately 51 mm (2 in.); then remove both hoses from the water pump.



5. Remove the two cap screws securing the water pump to the engine; then remove the water pump.

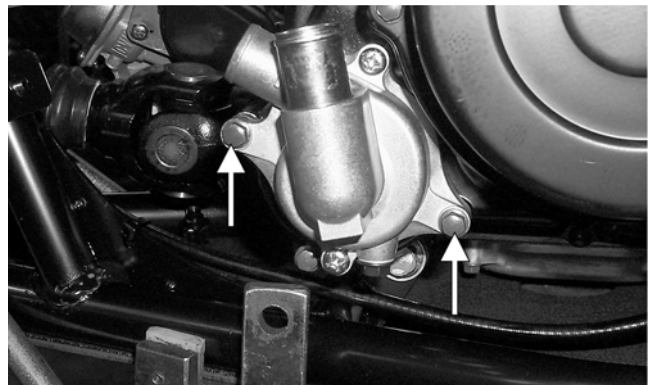

### INSTALLING

1. Secure the water pump to the engine with the two cap screws tightened securely.

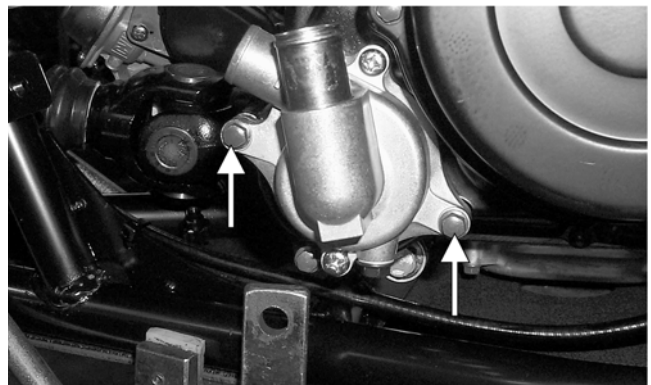

2. Connect the two coolant hoses to the water pump and secure with the clamps; then install the water pump coolant drain plug.



PR132

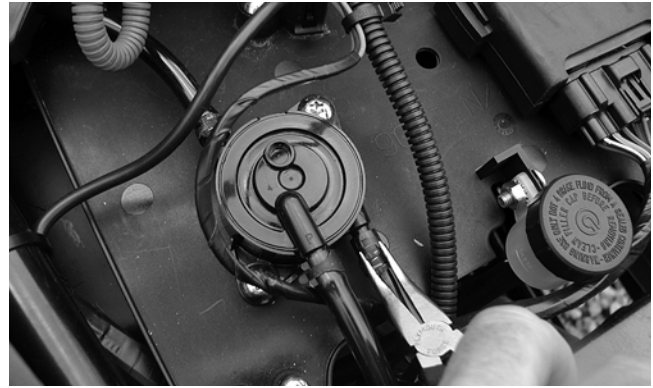

CD815

3. Fill the engine/transmission with the proper amount of recommended oil.
4. Fill the cooling system with the proper amount of recommended coolant.

■ **NOTE:** While the cooling system is being filled, air pockets may develop; therefore, run the engine for five minutes after the initial fill, shut the engine off, and then fill the cooling system.

5. Check the entire cooling system for leakage.

**⚠ CAUTION**

After operating the vehicle for the initial 5-10 minutes, stop the engine, allow the engine to cool down, and check the coolant level. Add coolant as necessary.

6. Install the right-side seat-base; then install the center console and seats making sure the seats lock securely.

## Vacuum Pulse Fuel Pump

**👉 AT THIS POINT**

Prior to removing the vacuum pulse fuel pump, the following test should be performed to determine that removal is necessary.

**⚠ WARNING**

Whenever any maintenance or inspection is made on the fuel system during which there may be fuel leakage, there should be no welding, smoking, open flames, etc., in the area.

### TESTING

1. Disconnect the fuel pump/carburetor hose at the fuel pump; then connect a hose and suitable pressure gauge to the fuel pump output fitting.

2. Start the engine. Fuel pump pressure should show 0.036-0.084 kg/cm<sup>2</sup> (0.5-1.2 psi).

### REMOVING

1. Remove the right-side seat-base; then remove the three clamps securing the gas hoses and vacuum hose and disconnect the hoses.

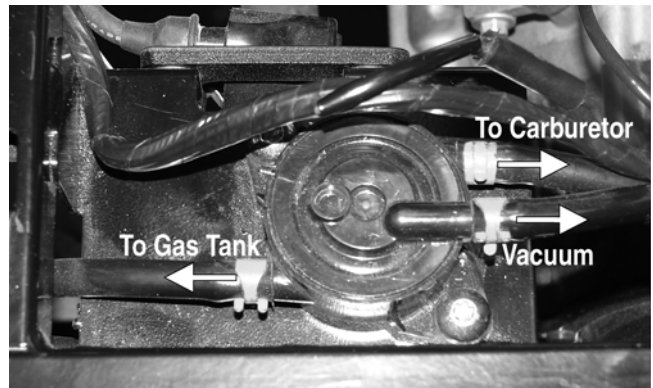

PR280A

2. Remove the two machine screws and flange nuts securing the fuel pump to the electrical tray; then remove the pump.

### INSTALLING

1. Place the fuel pump into position on the electrical tray; then secure with the machine screws and flange nuts. Tighten securely.
2. Connect two gas hoses and one vacuum hose; then secure with the clamps.

## Fuel Level Sensor (XT)

### REMOVING

1. Remove the seats and the center console; then remove the right-side seat base.

4

2. Remove the gasoline hose and disconnect the fuel level sensor connector; then remove four torx-head machine screws and the fuel level sensor mounting plate.

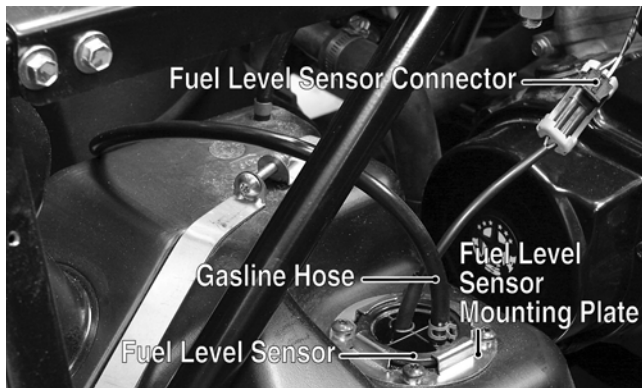

PR166C

3. Remove the fuel level sensor from the gas tank. Account for a seal.

## INSPECTING

1. Inspect the fuel screen and clean with low pressure compressed air.
2. Move the float lever and check for free movement. The float assembly should drop to the "empty" position when the fuel level sensor is held vertically. If there is binding or sticking, replace the fuel level sensor.
3. Test the fuel level sensor by connecting a multimeter (A) to the fuel level sensor connector (B); then select OHMS on the multimeter. The multimeter should read 5 ohms of resistance at "full fuel" position (C) and 95 ohms at the "empty fuel" position (D).

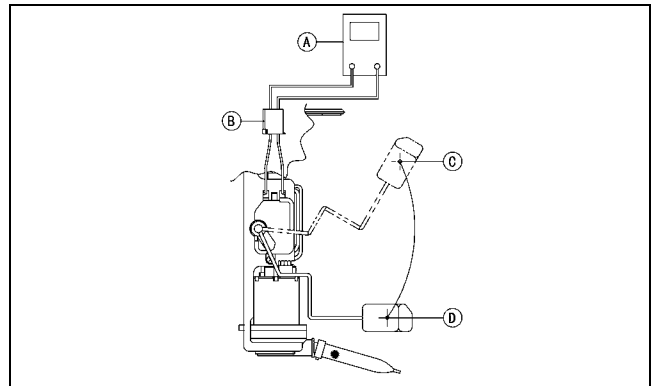

ATV2116

■ **NOTE:** If readings are erratic, clean the resistor wiper and resistor with a clean cloth soaked with alcohol and retest. If the readings shown are not as specified, replace the fuel level sensor assembly.

## INSTALLING

1. Using a new seal, place the fuel level sensor into position in the gas tank; then secure the fuel level sensor mounting plate. Tighten the four torx-head machine screws securely.
2. Connect the fuel level sensor connector to the main harness; then install the gasline hose and secure with the clamp.
3. Install the right-side seat base; then install the center console and seats making sure the seats lock securely into place.



# SECTION 5 - ELECTRICAL SYSTEM

---

---

## TABLE OF CONTENTS

---

---

5

Specifications .....	5-2
Battery .....	5-2
RPM Limiter.....	5-2
Testing Electrical Components.....	5-2
Accessory Receptacle/Connector .....	5-2
Brakelight Switch.....	5-2
Coolant Temperature and Cooling Fan Switches ....	5-3
Fan Motor .....	5-4
Power Distribution Module.....	5-4
Fuses .....	5-5
Ignition Coil .....	5-5
Speed Sensor (XT) .....	5-6
Ignition Switch .....	5-7
Headlight Switch .....	5-7
2WD/4WD Selector Switch.....	5-7
Differential Lock Switch (XT) .....	5-8
Reverse Override Switch.....	5-8
Front Drive Selector Actuator .....	5-8
Magneto Coils .....	5-9
Starter Motor .....	5-10
Starter Relay .....	5-11
CDI Unit.....	5-11
Regulator/Rectifier.....	5-12
Neutral Start/Start-in-Gear/2WD Relays .....	5-12
Headlights .....	5-12
Taillight-Brakelight .....	5-12
Ignition Timing .....	5-13

## Specifications

Prowler/XT		
IGNITION		
Ignition Timing		10° BTDC @ 1500 RPM
Spark Plug Type		Champion RG6YC
Spark Plug Gap		0.7-0.8 mm (0.028-0.032 in.)
Spark Plug Cap		3750-6250 ohms
Ignition Coil Resistance	(primary)	Less than 1 ohm (terminal to ground)
	(secondary)	5200-7800 ohms (high tension - plug cap removed - to ground)
Ignition Coil Peak Voltage	(primary/CDI)	142.4-213.6 DC volts (blue/white to ground)
MAGNETO		
Magneto Coil Resistance	(trigger)	160-240 ohms (green to blue)
	(source)	Less than 1 ohm (yellow to white)
	(charging)	Less than 1 ohm (black to black)
Magneto Coil Peak Voltage	(trigger)	4.2-6.3 volts (green to blue)
	(source)	0.40-0.62 volt (yellow to white)
Stator Coil Output	(no load)	60 AC volts @ 5000 RPM (black to black)
Magneto Output	(approx)	325W @ 5000 RPM

## Battery

For battery-related information, see Section 2.

## RPM Limiter

■ **NOTE:** The Prowler/XT models are equipped with a CDI unit that retards ignition timing when maximum RPM is approached. When the RPM limiter is activated, it could be misinterpreted as a high-speed misfire.

## Testing Electrical Components

All of the electrical tests should be made using the Fluke Model 73 Multimeter (p/n 0644-191) and when testing peak voltage, the Peak Voltage Reading Adapter (p/n 0644-307) must be used. If any other type of meter is used, readings may vary due to internal circuitry. When troubleshooting a specific component, always verify first that the fuse(s) are good, that the bulb(s) are good, that the connections are clean and tight, that the battery is fully charged, and that all appropriate switches are activated.

■ **NOTE:** For absolute accuracy, all tests should be made at room temperature of 68° F.

## Accessory Receptacle/Connector

■ **NOTE:** This test procedure is for either the receptacles or the connectors.

### VOLTAGE

1. Turn the ignition switch to the ON position; then set the meter selector to the DC Voltage position.
2. Connect the red tester lead to the red/white wire or the positive connector; then connect the black tester lead to ground.
3. The meter must show battery voltage.

■ **NOTE:** If the meter shows no battery voltage, troubleshoot the battery, fuse, receptacle, connector, or the main wiring harness.

## Brakelight Switch

The switch connector is the two-prong black connector below the master cylinder.

■ **NOTE:** The ignition switch must be in the ON position.

## VOLTAGE (Wiring Harness Connector)

1. Set the meter selector to the DC Voltage position.
2. Connect the red tester lead to the orange wire; then connect the black tester lead to ground.

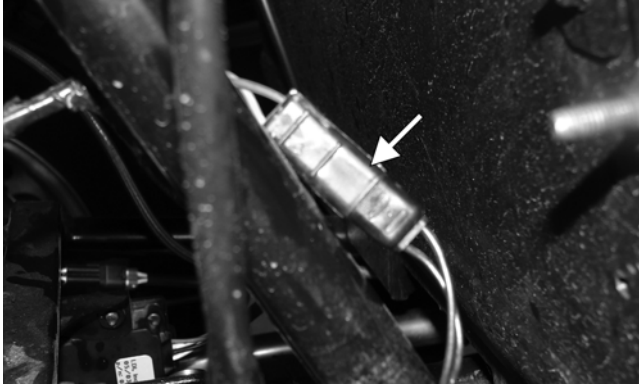

PR276A

3. The meter must show battery voltage.

■ **NOTE:** If the meter shows no battery voltage, troubleshoot the battery, fuse, switch, or the main wiring harness.

■ **NOTE:** If the meter shows battery voltage, the main wiring harness is good; proceed to test the switch/component, the connector, and the switch wiring harness for resistance.

## RESISTANCE (Switch Connector)

### ⚠ CAUTION

Always disconnect the battery when performing resistance tests to avoid damaging the multimeter.

■ **NOTE:** The brake pedal must be depressed for this test.

1. Set the meter selector to the OHMS position.
2. Connect the red tester lead to one black wire; then connect the black tester lead to the other black wire.



AR621D

3. When the lever is depressed, the meter must show less than 1 ohm.

■ **NOTE:** If the meter shows more than 1 ohm of resistance, replace the switch.

## Coolant Temperature and Cooling Fan Switches

1. Connect the meter leads (selector in the OHMS position) to the switch contacts.
2. Suspend the switch and a thermometer in a container of water; then heat the water.

■ **NOTE:** Neither the switch nor the thermometer should be allowed to touch the bottom of the container or inaccurate readings will occur. Use wire holders to suspend switch and thermometer.

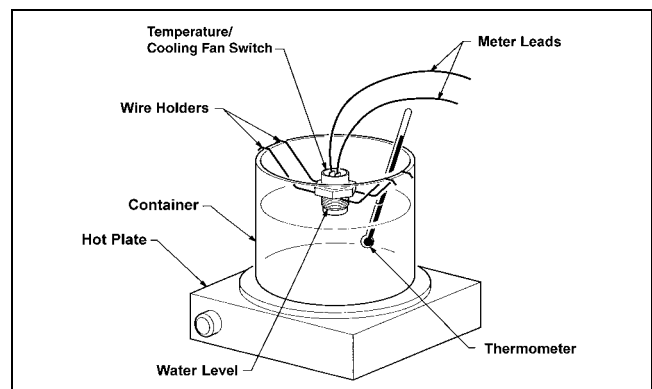

733-554E

3. On the coolant temperature switch when the water temperature reaches 112-118° C (234-244° F), the meter should show a closed circuit.



4. On the coolant temperature switch, allow the water to cool, and when the temperature is within a temperature range of 107-113° C (225-235° F), the meter should show an open circuit.
5. On the cooling fan switch when the temperature reaches 81-99° C (175-213° F), the meter should show a closed circuit.
6. On the cooling fan switch, allow the water to cool, and when the temperature is within a temperature range of 67-82° C (150-184° F), the meter should show an open circuit.
7. If the readings are not as indicated, the switch must be replaced.
8. Install the switch and tighten securely.
9. Connect the switch leads.

2. Connect the red tester lead to the red wire; then connect the black tester lead to the black wire.

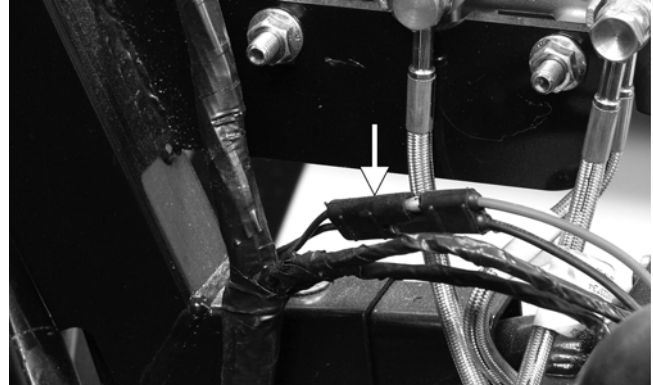

PR183A

3. The meter must show less than 1 ohm.

■ **NOTE:** If the meter shows more than 1 ohm of resistance, troubleshoot or replace the switch/component, the connector, or the switch wiring harness.

■ **NOTE:** To determine if the fan motor is good, connect the red wire from the fan connector to a 12 volt DC power supply; then connect the black wire from the fan connector to ground. The fan should operate.

## Fan Motor

■ **NOTE:** The ignition switch must be in the ON position.

### VOLTAGE (Main Harness Connector to Fan Motor)

1. Set the meter selector to the DC Voltage position.
2. Connect the red tester lead to the black/red wire (the black 2-prong at the fan motor); then connect the black tester lead to ground.
3. The meter must show battery voltage.

■ **NOTE:** If the meter shows no battery voltage, troubleshoot the battery, fuse, motor, or the main wiring harness.

■ **NOTE:** If the meter shows battery voltage, the main wiring harness is good. The connector should be checked for resistance.

### RESISTANCE (Fan Motor Connector)

#### CAUTION

Always disconnect the battery when performing resistance tests to avoid damaging the multimeter.

1. Set the meter selector to the OHMS position.

#### CAUTION

Care should be taken to keep clear of the fan blades.

## Power Distribution Module

The fuses are located in a power distribution module under the driver's seat.

If there is any type of electrical system failure, always check the fuses first.

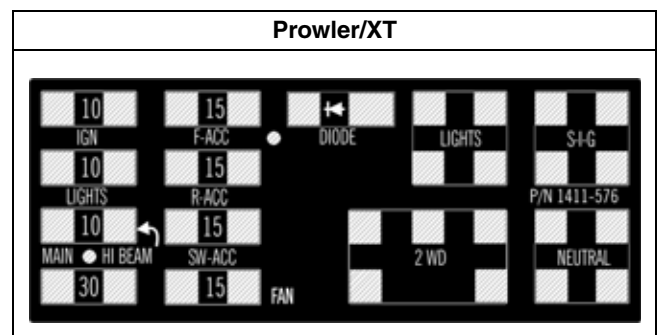

1411-576

1. Remove all fuses from the power distribution module.

2. Set the meter selector to the DC Voltage position.
3. Connect the black tester lead to ground.
4. Using the red tester lead, contact each end of the fuse holder connector terminals individually.
5. The meter must show battery voltage from one side of the connector terminal ends.

■ **NOTE:** Battery voltage will be indicated from only one side of the fuse holder connector terminal; the other side will show no voltage.

■ **NOTE:** When testing the HI fuse holder, the headlight OFF/HI/LO switch must be in the HI position; when testing the LIGHTS fuse holder, the headlight dimmer switch can be in either the HI or the LO position.

■ **NOTE:** If the meter shows no battery voltage, troubleshoot the battery, switches, power distribution module, or the main wiring harness.

## Fuses

### ⚠ CAUTION

Always disconnect the battery when performing resistance tests to avoid damaging the multimeter.

1. Set the meter selector to the OHMS position.
2. Connect the red tester lead to one spade end of the fuse; then connect the black tester lead to the other spade end.
3. The meter must show less than 1 ohm resistance. If the meter shows open, replace the fuse.

■ **NOTE:** Make sure the fuses are returned to their proper position according to amperage. Refer to the amperage listed under each fuse on the power distribution module.

## Ignition Coil

The ignition coil is mounted on the fuel pump mounting plate adjacent to the fuel pump.

### VOLTAGE (Primary Side)

See PEAK VOLTAGE Primary/CDI in this sub-section.

[www.mymowerparts.com](http://www.mymowerparts.com)

## RESISTANCE

### ⚠ CAUTION

Always disconnect the battery when performing resistance tests to avoid damaging the multimeter.

■ **NOTE:** For these tests, the meter selector should be set to the OHMS position.

### Primary Winding

1. Connect the red tester lead to the terminal (with the wire removed); then connect the black tester lead to ground.

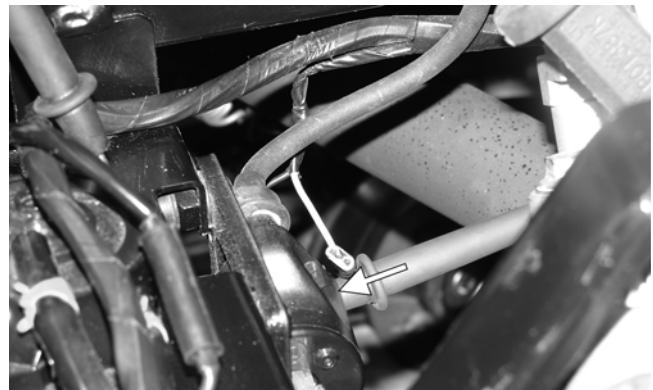

PR278A

2. The meter reading must be within specification.

### Secondary Winding

1. Connect the red tester lead to the high tension lead (with the plug cap removed); then connect the black tester lead to ground.
2. The meter reading must be within specification.

■ **NOTE:** If the meter does not show as specified, replace ignition coil.

### Spark Plug Cap

1. Connect the red tester lead to one end of the cap; then connect the black tester lead to the other end of the cap.

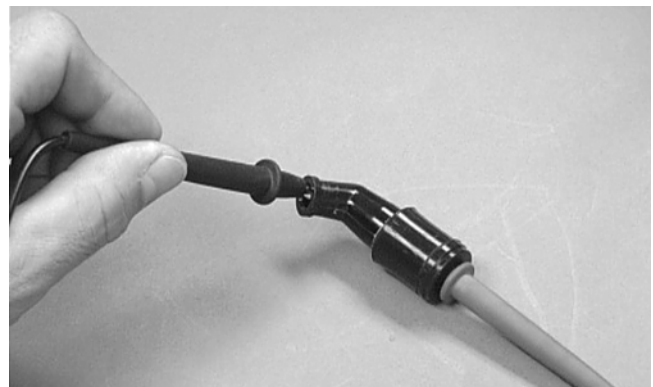

AR603D

2. The meter reading must be within specification.

■ **NOTE:** If the meter does not show as specified, replace the spark plug cap.

## PEAK VOLTAGE

■ **NOTE:** All of the peak voltage tests should be made using the Fluke Model 73 Multimeter (p/n 0644-191) with Peak Voltage Reading Adapter (p/n 0644-307). If any other type of tester is used, readings may vary due to internal circuitry.

■ **NOTE:** The battery must be at full charge for these tests.

## Primary/CDI

■ **NOTE:** The CDI is located beneath the driver's seat above the battery.

1. Set the meter selector to the DC Voltage position; then disconnect the blue/white primary wire from the coil.
2. Connect the red tester lead to the primary wire; then connect the black tester lead to ground.

### **WARNING**

**Do not touch the primary wire with the ignition switch turned on or severe electrical shock will occur.**

3. Turn the ignition switch to the ON position.
4. The meter must be within specification.
5. With the test leads still connected, crank the engine with the electric starter.
6. The meter must show 300-450 DC volts.

---

## Speed Sensor (XT)

---

■ **NOTE:** Prior to testing the speed sensor, inspect the three-wire connector on the speed sensor for contamination, broken pins, and/or corrosion.

1. Set the meter selector to the DC Voltage position.
2. With appropriate needle adapters on the meter leads, connect the red tester lead to the voltage lead (V); then connect the black tester lead to the ground lead (G).

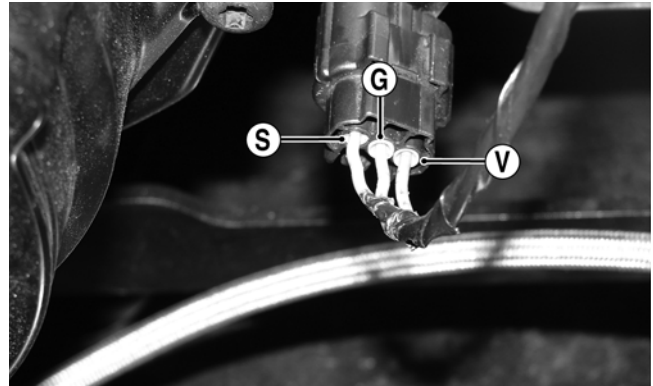

PR279A

3. Turn the ignition switch to the ON position.
4. The meter must show approximately 6 DC volts.
5. Leave the black tester lead connected; then connect the red tester lead to the signal lead pin (S).
6. Slowly move the vehicle forward or backward; the meter must show 0 and approximately 6 DC volts alternately.

■ **NOTE:** If the sensor tests are within specifications, the speedometer must be replaced (see Section 9).

To replace a speed sensor, use the following procedure.

1. Disconnect the three-wire connector from the speed sensor harness or from the speed sensor; then remove the Allen-head cap screw securing the sensor to the sensor housing.
2. Remove the sensor from the sensor housing accounting for an O-ring.



CD070

3. Install the new speed sensor into the housing with new O-ring lightly coated with multi-purpose grease; then secure the sensor with the Allen-head cap screw (threads coated with blue Loctite #242). Tighten securely.



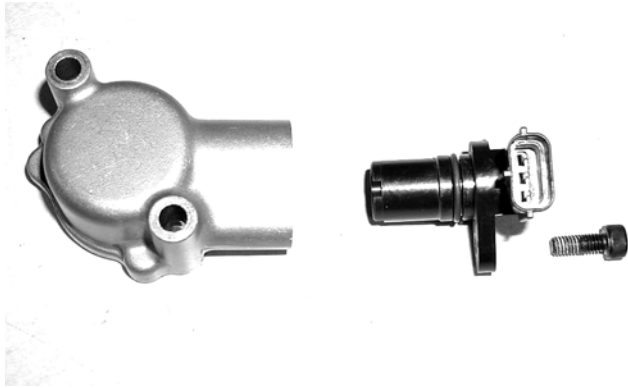

CD071

## Ignition Switch

To access the ignition switch, dash switches, front accessory connectors, and front switched accessory connector, the dash must be unfastened and slid to the rear.

### VOLTAGE

1. Set the meter selector to the DC Voltage position.
2. Connect the red meter lead to the red wire; then connect the black meter lead to ground.
3. Meter must show battery voltage.

■ **NOTE:** If the meter shows no battery voltage, troubleshoot the main 30 amp fuse, the battery, or the main wiring harness.

4. Connect the red meter lead to the red/black wire; then with the black lead grounded, turn the ignition switch to the ON position. The meter must show battery voltage.
5. Connect the red meter lead to the yellow/green wire; then with the black lead grounded, turn the ignition switch to the START position. The starter should engage and the meter must show battery voltage.

■ **NOTE:** When the starter is engaged, battery voltage will be approximately 10.5 DC volts.

## Headlight Switch

### VOLTAGE

1. Connect the red meter lead to the gray wire; then connect the black meter lead to the black wire.
2. Turn the ignition switch to the ON position. The meter must show battery voltage.

■ **NOTE:** If the meter does not show battery voltage, troubleshoot the LIGHTS fuse on the power distribution module, the ignition switch, or the main harness.

3. Connect the red meter lead to the yellow wire; then select the high beam position on the headlight switch. The meter must show battery voltage.
4. Connect the red meter lead to either of the two white wires; then select the low beam position on the headlight switch. The meter must show battery voltage.

■ **NOTE:** The battery voltage will show lower in steps 3 and 4 due to electrical loading of the headlights.

## 2WD/4WD Selector Switch

### VOLTAGE

1. Connect the red meter lead to the gray wire; then connect the black meter lead to the black wire. Turn the ignition switch to the ON position. The meter must show battery voltage.

■ **NOTE:** If the meter does not show battery voltage, troubleshoot the LIGHTS fuse on the power distribution module, the ignition switch, or the main wiring harness.

2. Connect the red meter lead to the white/red wire; then select 2WD on the selector switch. The meter must show battery voltage.
3. Connect the red meter lead to the white/green wire. The meter must show approximately 9.5 DC volts.
4. Select 4WD on the selector switch. The meter must show 0 DC volts.

## Differential Lock Switch (XT)

### VOLTAGE

1. Select DC Voltage on the multimeter; then connect the red tester lead to the switch terminal (leaving the wire connected) and the black tester lead to ground.

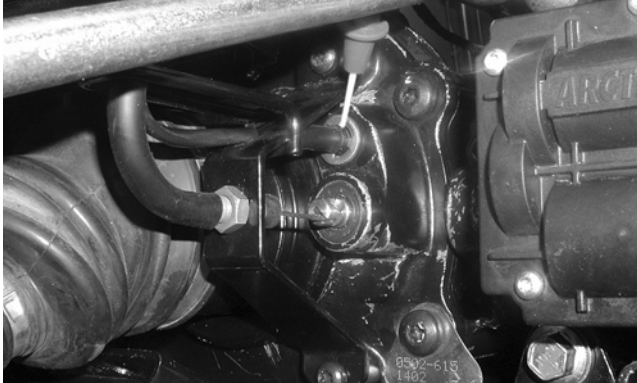

CD575

2. Turn the ignition switch to the ON position. The meter must show 12 DC volts.

■ **NOTE:** If no voltage is indicated, check the wiring harness, fuse, or battery connections.

3. Select the lock position on the differential. The meter should drop to 0 volts, and the front drive actuator should operate to engage 4-wheel drive.

■ **NOTE:** It may be necessary to rock the vehicle slightly to engage the differential lock fully.

■ **NOTE:** The 4WD and LOCK icons in the upper-left corner of the LCD should illuminate.



CF094C

4. If the differential lock engages (front wheels locked) and the voltage does not drop to 0, the switch is faulty and must be cleaned or replaced.

## Reverse Override Switch

### VOLTAGE

■ **NOTE:** To perform the following tests, the ignition switch must be in the ON position and the transmission shifted into reverse gear.

1. Connect the red meter lead to the black/blue wire and the black meter lead to a suitable ground; then select 2WD on the 2WD/4WD selector switch. The meter must show approximately 1.5 DC volts.
2. Depress the reverse override switch. The meter showing should not change from step 1.
3. Select 4WD on the 2WD/4WD selector switch. The meter must show approximately 5 DC volts.
4. Depress the reverse override switch. The meter must show approximately 1.5 DC volts.
5. Connect the red meter lead to the red/yellow wire. The meter must show approximately 1.5 DC volts. Depress the reverse override switch. The meter must show approximately 1.5 DC volts.
6. Connect the red meter lead to the red/green wire. The meter should show 0 DC volts.
7. Depress the reverse override switch. The meter must show approximately 5 DC volts.

## Front Drive Selector Actuator

■ **NOTE:** With the engine stopped and the ignition switch in the ON position, a momentary “whirring” sound must be noticeable each time the selector switch is moved to 2WD and 4WD. Test the switch, 30 amp fuse, and wiring connections prior to testing the actuator.

■ **NOTE:** The differential must be in the unlocked position for this procedure.

## VOLTAGE

1. Locate the 4-wire connector for the front drive selector actuator on the frame to the right of the differential; then connect the red meter lead to the orange wire using a MaxiClip (p/n 0744-041).



PR293

2. Connect the black lead to the black wire using a MaxiClip (p/n 0744-041); then select 2WD on the 2WD/4WD selector switch.



PR295

■ **NOTE:** The black tester lead can remain connected to the black wire for the remaining tests.

3. Turn the ignition switch to the ON position. The meter must show battery voltage.

■ **NOTE:** If battery voltage is not shown, troubleshoot the 10 amp ignition (IGN) fuse on the power distribution module, the ignition switch, or the main wiring harness.

4. Connect the red meter lead to the white/red wire. The meter must show battery voltage.
5. Select 4WD on the 2WD/4WD selector switch. The meter must show 0 DC volts.
6. Connect the red meter lead to the white/orange wire. The meter must show battery voltage.
7. Engage the differential lock. The meter must show 0 DC volts.

■ **NOTE:** If the meter does not show 0 DC volts, rock the vehicle to help engage the differential lock; then troubleshoot the differential lock switch (see Differential Lock Switch - XT in this section).

## Magneto Coils

### VOLTAGE (Stator Coil - Output)

1. Set the meter selector to the DC Voltage position.
2. Connect the red tester lead to the positive battery post; then connect the black tester lead to the negative battery post.
3. With the engine running at a constant 5000 RPM (with the headlights on), the meter must show 14-15.5 DC volts.

#### ⚠ CAUTION

Do not run the engine at high RPM for more than 10 seconds.

■ **NOTE:** If voltage is lower than specified, test stator coil - no load.

### VOLTAGE (Stator Coil - No Load)

The connector is the three-wire one on the left side of the engine just above the centrifugal clutch housing.

■ **NOTE:** Test the connector that comes from the engine.

1. Set the meter selector to the AC Voltage position.
2. Test between the three black wires for a total of three tests.
3. With the engine running at the specified RPM, all wire tests must be within specification.

#### ⚠ CAUTION

Do not run the engine at high RPM for more than 10 seconds.

■ **NOTE:** If both stator coil tests failed, check all connections, etc., and test again. If no voltage is present, replace the stator assembly.



## RESISTANCE (Charging Coil)

### ⚠ CAUTION

Always disconnect the battery when performing resistance tests to avoid damaging the multimeter.

1. Set the meter selector to OHMS position.
2. Test between the three black wires for a total of three tests.
3. The meter reading must be within specification.

## RESISTANCE (Trigger Coil)

### ⚠ CAUTION

Always disconnect the battery when performing resistance tests to avoid damaging the multimeter.

1. Set the meter selector to the OHMS position.
2. Connect the red tester lead to the green wire; then connect the black tester lead to the blue wire. The meter reading must be within specification.

## RESISTANCE (Source Coil)

1. Set the meter selector to the OHMS position.
2. Connect the red tester lead to the yellow wire; then connect the black tester lead to the white wire.
3. The meter reading must be within specification.

■ **NOTE:** If the meter shows other than specified in any resistance test, replace the stator assembly.

## PEAK VOLTAGE

■ **NOTE:** All of the peak voltage tests should be made using the Fluke Model 73 Multimeter (p/n 0644-191) with Peak Voltage Reading Adapter (p/n 0644-307). If any other type of tester is used, readings may vary due to internal circuitry.

■ **NOTE:** The battery must be at full charge for these tests.

## Magneto Coil (Trigger)

1. Set the meter selector to the DC Voltage position.
2. Connect the red tester lead to the green wire; then connect the black tester lead to the blue wire.
3. Crank the engine over using the electric starter.

4. The meter reading must be within specification.

## Magneto Coil (Source)

1. Set the meter selector to the DC Voltage position.
2. Connect the red tester lead to the yellow wire; then connect the black tester lead to the white wire.
3. Crank the engine over using the electric starter.
4. The meter reading must be within specification.

---

---

## Starter Motor

---

■ **NOTE:** The starter motor is not a serviceable component. If the motor is defective, it must be replaced.

## REMOVING

1. Disconnect the battery.

### ⚠ CAUTION

Always disconnect the negative battery cable from the battery first; then disconnect the positive cable.

2. Remove the nut securing the positive cable to the starter; then remove the cable from the starter.
3. Remove the two cap screws securing the starter with ground wires to the crankcase; then remove the starter. Account for the wiring forms and an O-ring.

## INSTALLING

1. Apply a small amount of grease to the O-ring seal on the starter; then install the starter into the crankcase. Secure with two machine screws and wiring forms.
2. Secure the positive cable to the starter with the nut.
3. Connect the battery.

## TESTING VOLTAGE

Perform this test on the starter motor positive terminal. To access the terminal, slide the boot away.

■ **NOTE:** The ignition switch must be in the ON position, and the shift lever in the NEUTRAL position.

1. Set the meter selector to the DC Voltage position.
2. Connect the red tester lead to the starter terminal; then connect the black tester lead to ground.
3. With the starter button depressed, the meter must show battery voltage and the starter motor should operate.

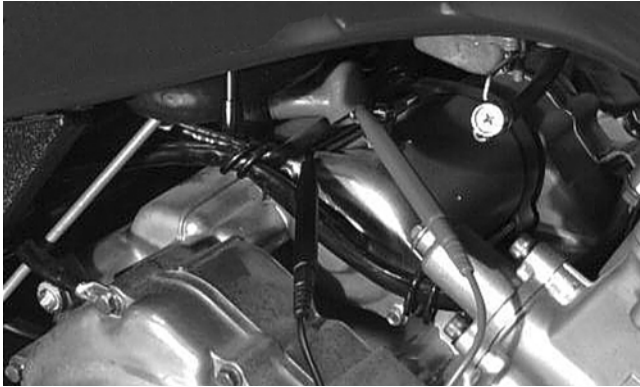

AR607D

■ **NOTE:** If the meter showed battery voltage but the starter did not operate or operated slowly, inspect battery voltage (at the battery), starter motor condition, and/or ground connections.

■ **NOTE:** If the meter showed no battery voltage, inspect the main fuse, ground connections, starter motor lead, battery voltage (at the battery), starter relay, or the neutral start relay.

---

---

## Starter Relay

---

1. Remove the operator's seat; then using the multimeter set to the DC Voltage position, check the relay as follows.
2. Connect the red tester lead to the positive battery terminal; then connect the black tester lead to the starter cable connection on the starter relay. The meter must show battery voltage.



PR296

■ **NOTE:** Make sure that the ignition switch is in the ON position, transmission in neutral, and parking brake set.

3. Depress the starter button while observing the multimeter. The multimeter should drop to 0 volts and a "click" should be heard from the relay.

■ **NOTE:** If a "click" is heard and any voltage is indicated by the multimeter, replace the starter relay. If no "click" is heard and the multimeter continues to indicate battery voltage, proceed to step 4.

4. Disconnect the two-wire plug from the starter relay; then connect the red tester lead to the green wire and the black tester lead to the black wire.

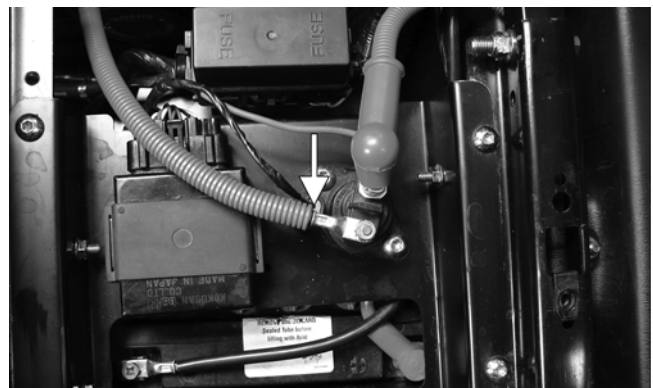

PR297A

5. Depress the starter button and observe the multimeter.

■ **NOTE:** If battery voltage is indicated, replace the starter relay. If no voltage is indicated, proceed to Neutral Start Relay check.

---

---

## CDI Unit

---

The CDI is located beneath the operator's seat near the battery.

■ **NOTE:** The CDI unit is not a serviceable component. If the unit is defective, it must be replaced.

The CDI is rarely the cause for electrical problems; however, if the CDI is suspected, substitute another CDI unit to verify the suspected one is defective.

■ **NOTE:** Prior to replacing the CDI unit to assure the CDI unit is defective, it is advisable to perform a CDI peak voltage test (see Ignition Coil in this section) and/or perform a continuity test of the wiring harness from the CDI connector to the CDI unit.

---

---

## Regulator/Rectifier

---

The regulator/rectifier is located under the driver's seat next to the battery. Try to verify all other charging system components before the regulator/rectifier is replaced.

### TESTING

1. Start engine and warm up to normal operating temperatures; then connect a multimeter (set at the DC Voltage position) to the battery as follows.
2. Connect the red tester lead to the positive battery post and the black tester lead to the negative battery post.
3. Slowly increase RPM. The voltage should increase with the engine RPM to a maximum of 15.5 DC volts.

■ **NOTE:** If voltage rises above 15.5 DC volts, the regulator is faulty or a battery connection is loose or corroded. Clean and tighten battery connections or replace the regulator/rectifier. If voltage does not rise, check Voltage (Charging Coil - No Load) in this section. If charging coil voltage is normal, replace the regulator/rectifier.

---

---

## Neutral Start/ Start-in-Gear/ 2WD Relays

---

The relays are identical plug-in type located on the power distribution module. Relay function can be checked by switching relay positions. The relays are interchangeable.

■ **NOTE:** The module and wiring harness are not a serviceable component and must be replaced as an assembly.

---

---

## Headlights

---

The connectors are the four 2-prong ones secured to the headlight bulbs (two on each side).

### VOLTAGE

■ **NOTE:** The low beams are the outside bulbs (black and white wires) and the high beams are the inside bulbs (yellow and black wires). Always connect the black tester lead to the black wires. The ignition switch must be in the ON position.

1. Set the meter selector to the DC Voltage position.
2. Set the light switch to the correct position for the affected light; then connect the black tester lead to the black wire using a MaxiClip (p/n 0744-041).
3. Connect the red tester lead to the yellow wire (high beam) or white wire (low beam) using a MaxiClip (p/n 0744-041). The meter must show battery voltage.

■ **NOTE:** If battery voltage is not shown in any test, inspect the LIGHTS fuse on the power distribution module, headlight switch, ignition switch, switch connectors, or wiring harness.

---

---

## Taillight-Brakelight

---

### VOLTAGE (Taillight)

■ **NOTE:** Perform this test at the socket end of the taillight-brakelight harness (pigtail). The ignition switch must be in the ON position and either high beam or low beam selected on the light switch.

1. Set the meter selector to the DC Voltage position.
2. Connect the black tester lead to the black wire; then connect the red tester lead to the white wire. The meter should show battery voltage.
3. With the ignition key in the LIGHTS position, the meter must show battery voltage.

■ **NOTE:** If battery voltage is not shown and the headlights are illuminated, inspect the three-wire connector in the left-rear canopy tube at the juncture of the canopy tube and lower frame. If battery voltage is shown on the meter, replace the bulb.

### VOLTAGE (Brakelight)

■ **NOTE:** Perform this test at the socket end of the taillight/brakelight harness (pigtail). The ignition switch must be in the ON position.



1. Set the meter selector to the DC Voltage position.
2. Connect the red tester lead to the red/blue wire; then connect the black tester lead to the black wire.
3. With the brake applied, the meter must show battery voltage.

■ **NOTE:** If the meter shows no voltage, inspect the 10 amp ignition (IGN) fuse, brakelight switch, wiring harness, or connectors.

---

---

## Ignition Timing

---

The ignition timing cannot be adjusted; however, verifying ignition timing can aid in troubleshooting other components.

To verify engine timing, see Section 2.

# SECTION 6 - DRIVE SYSTEM

---

---

## TABLE OF CONTENTS

---

Drive System .....	6-2
General Information.....	6-2
Front Drive Actuator .....	6-2
Front Differential .....	6-4
Drive Axles .....	6-16
Rear Gear Case .....	6-21
Hub.....	6-22
Hydraulic Brake Caliper.....	6-24
Universal Joints .....	6-26

## Drive System

■ **NOTE:** Some photographs and illustrations used in this section are used for clarity purposes only and are not designed to depict actual conditions.

■ **NOTE:** Critical torque specifications are located in Section 10.

## General Information

All gear cases are tagged beneath a cover bolt. This tag is marked with a production date code, sequence code, and a ratio code. All gear cases are 4.0:1 ratio.

The die-cast aluminum housings have been assembled with thread-rolling screws (trilobular). When assembling with these screws, start the screws carefully into the housing; then use the following torque values.

Size	New Housing	Reassembled Housing
M6 (Torx T-30 Recess)	1.1-1.3 kg-m (8-9.5 ft-lb)	0.9-1.2 kg-m (6.5-9 ft-lb)
M8 (Torx T-40 Recess)	3.5-4.3 kg-m (25-31 ft-lb)	2.9-3.5 kg-m (21-25 ft-lb)

### TROUBLESHOOTING

If a noise is heard from the gear case area, it can be difficult to locate and/or diagnose. If the noise is related to wheel speed, but not to engine RPM, the problem is probably in the final drive or engine/transmission bevel gear set. When a problem is localized, a number of inspections must be made to pinpoint that problem. The most obvious of the inspections include CV boots, wheel and hub nut tightness, wheel bearing damage, gear case lubricant contamination, low lubricant level, seal leakage, CV joints, or selector arm.

■ **NOTE:** Small metallic particles will collect on the magnetic drain plug as a normal part of break-in and will also give a metallic cast to drained lubricant. Contamination would include large particles or water which gives a “milky” look to the lubricant.

■ **NOTE:** Lubricant on a new pinion housing assembly could be grease. If the front of the gear case is leaking at the rear drive boot, wipe excess lubricant from the bottom of the pinion housing; then operate the vehicle for a period of time. Inspect the pinion housing area for any signs of leakage. If lubricant is again on the bottom of the pinion housing, the seal must be replaced.

Additional troubleshooting could include the following.

- Binding/abrupt motion: CV boot torn (grease loss, foreign object damage, broken cage); gear lubricant loss or not filled (bearing seizure, broken gear teeth, seal leakage, bladder or hose leakage, missing filler/drain plug).
- Noise from drive system: wheel or gear case bearing damage, improper gear backlash, improper assembly, low or no gear case lubricant.
- Lockup: gear case lubricant loss or not filled, water contamination causing bearing seizure.

## Front Drive Actuator

■ **NOTE:** The actuator is not a serviceable component. If it is defective, it must be replaced.

■ **NOTE:** The actuator will operate only when the ignition switch is in the ON position.

The front drive actuator is located on the right side of the front drive input housing. With the engine stopped and the ignition switch in the ON position, a momentary “whirring” sound can be heard each time the front drive selector switch is shifted. If no sound is heard, see Section 5. If the actuator runs constantly or makes squealing or grinding sounds, the actuator must be replaced.

### REMOVING

1. Select 4WD on the front drive selector switch; then disconnect the connector on the actuator harness.
2. Using a T-30 torx wrench, remove the mounting cap screw from the driveshaft side of the actuator.



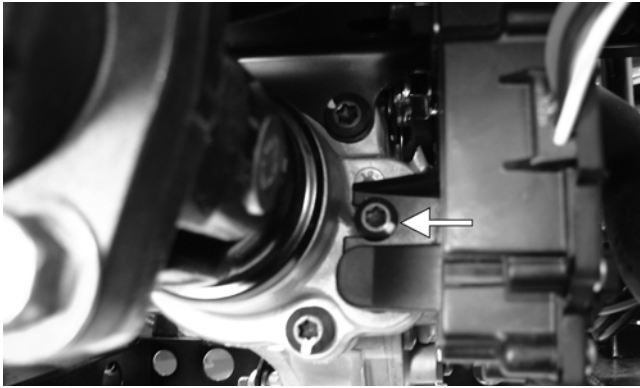

PR189A

3. Remove the mounting cap screw from above the actuator on the suspension side.

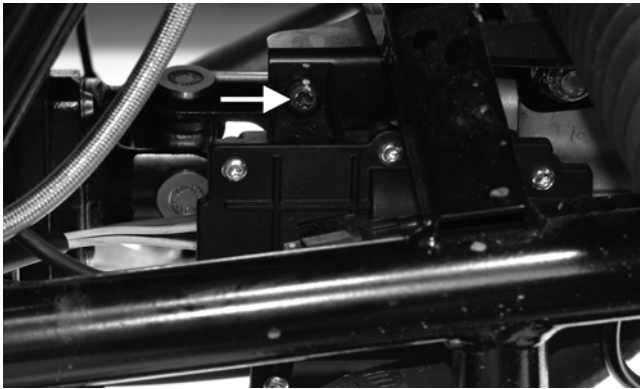

PR190A

4. Loosen but do not remove the mounting cap screw at the front of the actuator; then slide the actuator to the rear enough to clear the slotted mounting tab and the selector shaft. Remove from the right side.

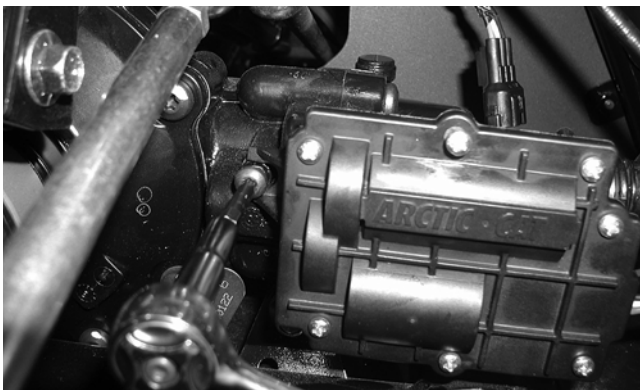

AG928

## INSTALLING

1. Lubricate the O-ring on the actuator; then ensure that all mounting surfaces are clean and free of debris.
2. Align the actuator with the selector shaft and slide it forward onto the shaft taking care to engage the cap screw in the slot of the front mounting tab.

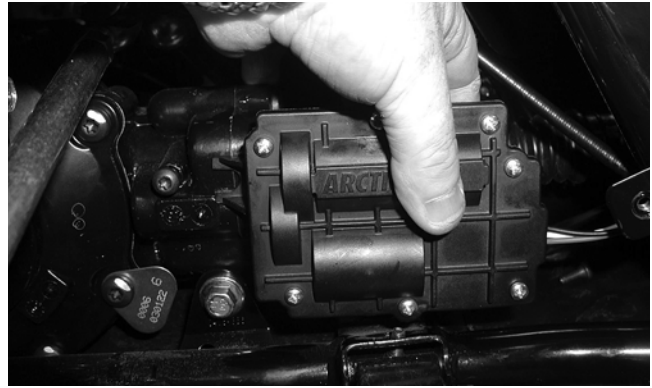

AG925

3. While holding the actuator firmly forward, tighten the front cap screw to hold the actuator in place; then install but do not tighten the two remaining cap screws.

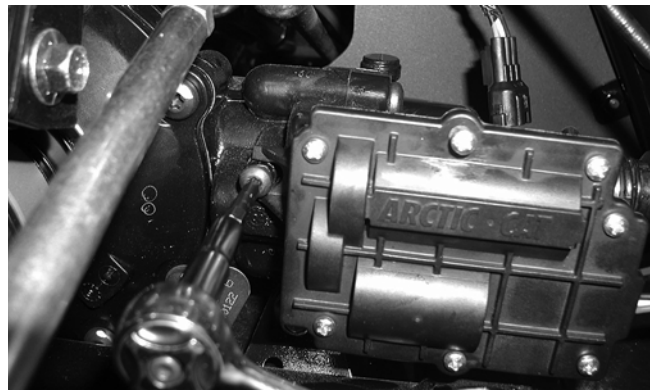

AG928

4. Loosen the front cap screw; then tighten the cap screw on the driveshaft side.



AG926

■ **NOTE:** It is important to tighten this cap screw while the others are loose to ensure proper seating of the actuator.

5. Tighten the remaining cap screws; then connect the electrical plug to the main harness.
6. Turn the ignition switch to the ON position and check the operation by shifting the selector switch several times.

7. Secure the wiring harness to the frame with a nylon cable tie; then install the inner fender panel.

---

## Front Differential

---

### REMOVING

1. Remove the belly panel; then place the vehicle on jack stands adjusted high enough to allow working from the underside of the vehicle.

■ **NOTE:** The jack stands should be placed under the main frame to avoid contact with front suspension components.

 **WARNING**

Make sure the vehicle is solidly supported on the jack stands to avoid injury.

2. Remove the drain plug and drain the gear lubricant into a drain pan; then install the plug.

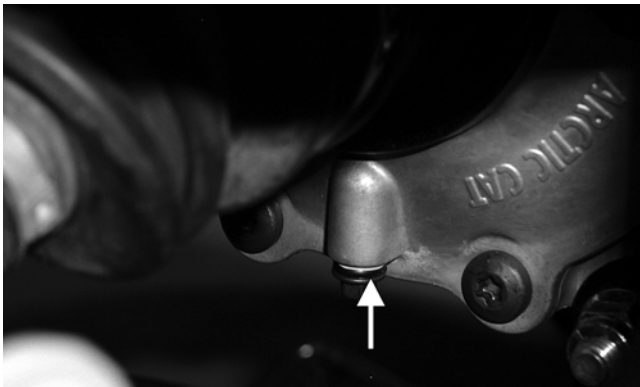

PR022A

3. Remove the front wheels.
4. Set the parking brake; then turn the ignition switch to the ON position and select 4WD on the 2WD/4WD selector switch.
5. Remove the cotter pin securing the hex nut; then remove the hex nut.
6. Release the parking brake.

■ **NOTE:** It is not necessary to remove the brake hoses from the calipers for this procedure.

7. Remove the two brake calipers. Account for the four cap screws; then remove the hubs.



AF894D

8. Disconnect the front drive actuator power connector from the main harness; then on the XT, disconnect the differential lock indicator connector from the differential lock switch located on the right-side of the differential.

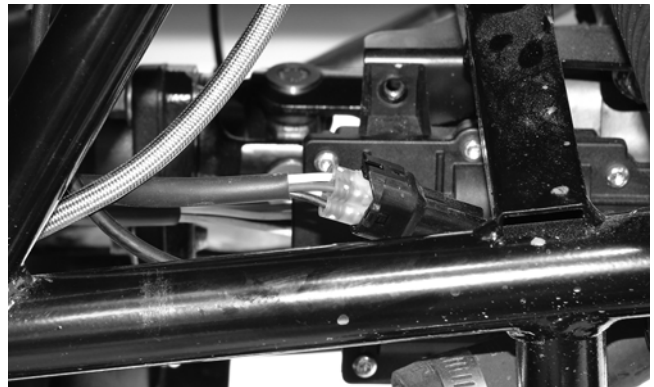

PR191

9. On the XT, remove two cap screws securing the differential lock cable support; then disconnect the differential lock cable at the differential.

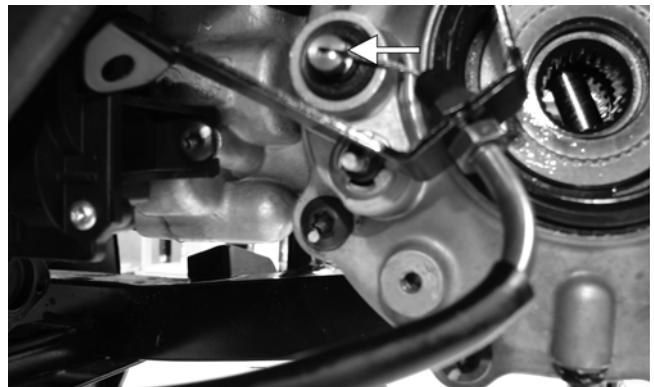

PR194A



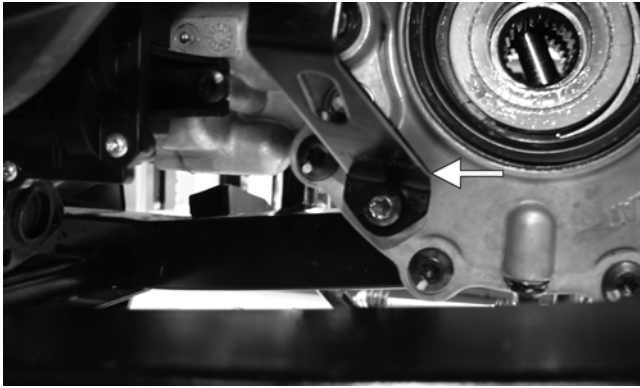

PR195A

10. Remove the lower and upper ball joint cap screws taking care not to strip the threads on the ball joint shaft; then using a rubber mallet, tap the end of the axle and free it from the knuckle assembly.

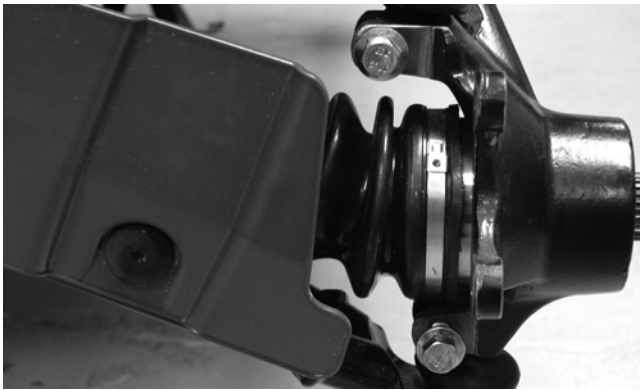

PR193

11. Pull the steering knuckle away from the axle taking care not to damage the seals with the axle end.



PR222

12. Support the axle to not allow it to drop or hang.

**⚠ CAUTION**

The axle must be supported. If the axle is allowed to drop or hang, damage to the inner CV joint may occur.

13. Remove the lower shock bolts. Account for the lock nuts; then move the shocks and upper A-arm up and secure them with a strap.

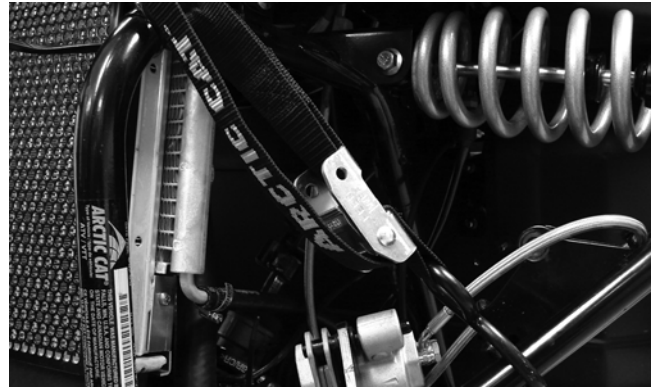

PR200

14. Scribe match marks on the front input drive flange and the front drive yoke flange; then remove three cap screws securing the yoke and flange. Separate the flanges but do not remove the driveshaft.

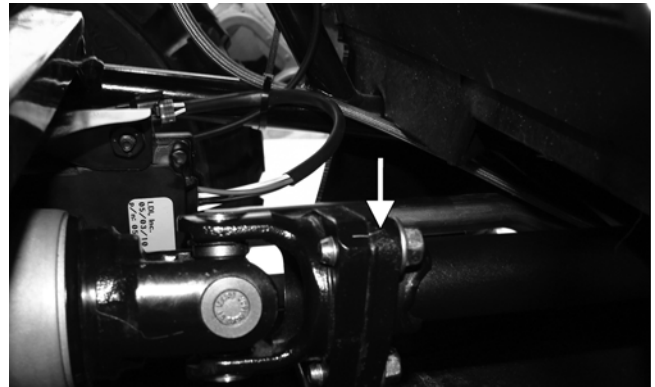

PR198A

15. Using a slide hammer, remove the front axles.



PR199

16. Remove the lower differential mounting cap screw. Account for a lock nut and four washers. Note the position of the washers for assembling.



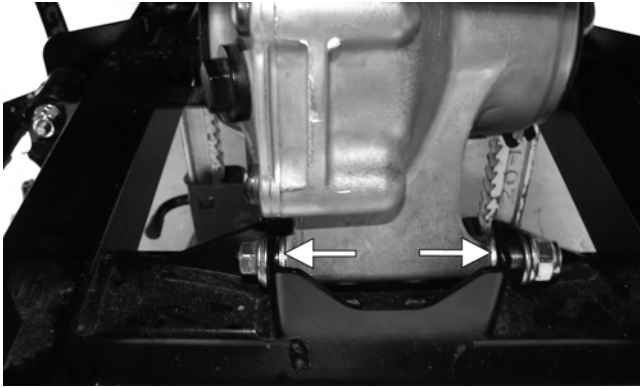

PR205A

17. Remove the upper differential mounting cap screw. Account for a lock nut and two washers.



CD016

18. Free the differential assembly from the frame mountings; then lower the differential through the frame.

### Disassembling Input Shaft

1. Using a T-40 torx wrench, remove the cap screws securing the pinion housing.

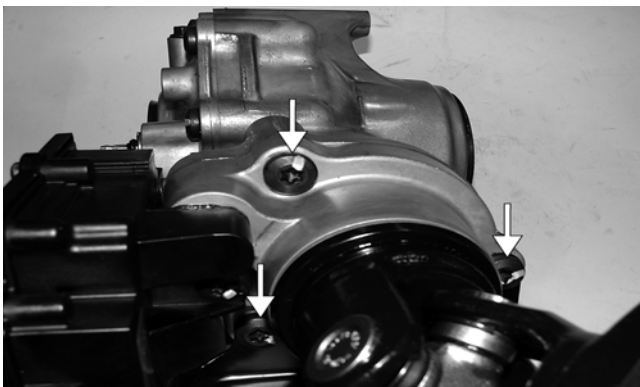

PR261A

2. Using a rubber mallet, remove the housing. Account for a gasket. Remove the fork, collar, and spring. Note the location of all the components for assembling purposes.

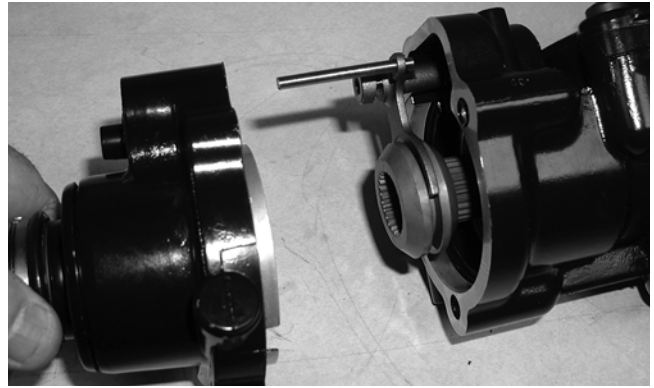

CD103



CD106

3. Remove the input shaft from the pinion housing.



CD107

4. Using a seal removal tool, remove the input shaft seal. Account for a spacer.



AF982

5. Remove the snap ring securing the input shaft bearing; then place the pinion housing in a press and remove the bearing.



AF983

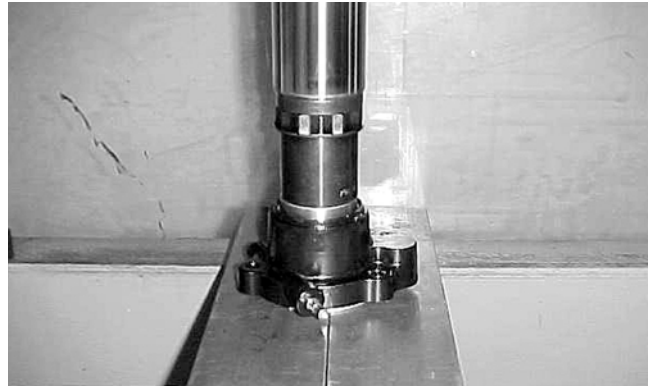

AF993

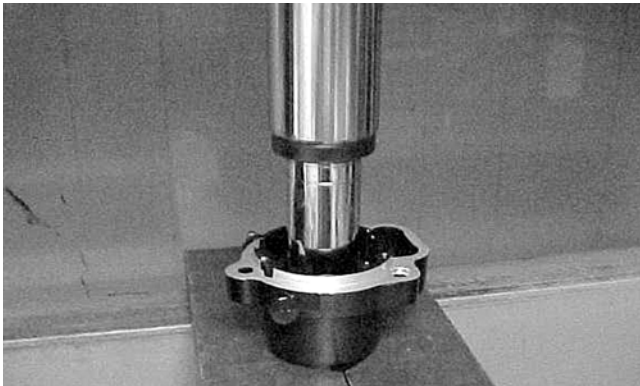

AF984



AF994

2. Install the input shaft seal making sure it is flush with the edge of the housing.
3. Lubricate the input shaft splines with High-Performance Grease.

■ **NOTE:** Any time drive splines are separated, clean all splines with parts-cleaning solvent and dry with compressed air; then lubricate with recommended grease.

**6**



KX219

### Assembling Input Shaft

1. Place the pinion housing in a press and install the input shaft bearing. Secure the bearing with the existing snap ring making sure the sharp edge of the snap ring faces to the outside.



KX221





KX222

4. Install the input shaft into the pinion housing; then secure in the bearing with a circlip.



KX210A

5. Place the pinion housing with new gasket onto the gear case housing; then secure with existing cap screws. Tighten to specifications.

■ **NOTE:** If a new gear case housing is being installed, tighten the cap screws to 3.5-4.3 kg-m (25-31 ft-lb).



KX209

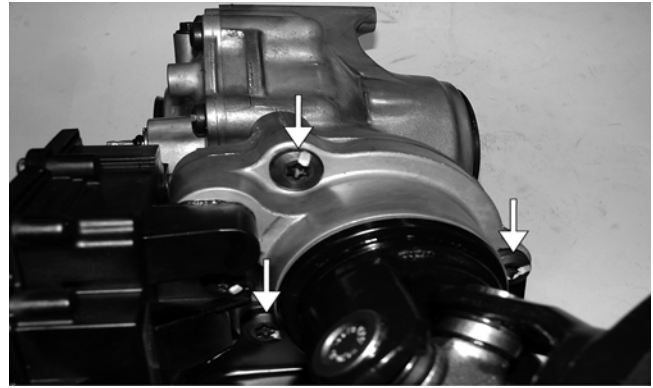

PR261A

## Disassembling Pinion Gear

■ **NOTE:** This procedure can be performed on a rear gear case.

1. Using a T-40 torx wrench, remove the cap screws securing the pinion housing. Account for the coupler, fork, and spring.



KX209

2. Using a T-40 torx wrench, remove the cap screws securing the gear case cover. Account for and make note of the ID tag location for assembling purposes.

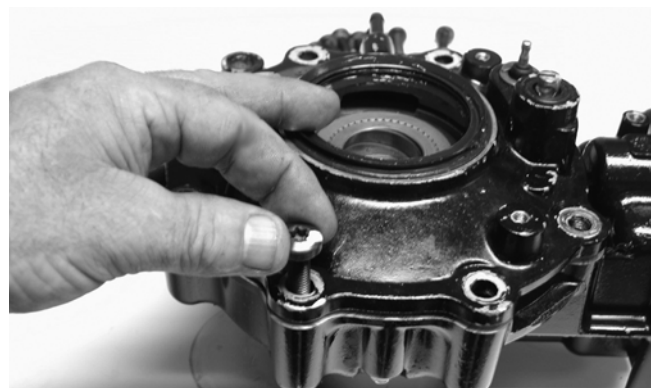

KX173

3. Using a plastic mallet, tap lightly to remove the differential cover. Account for an O-ring.





KX174

■ **NOTE:** If the cover is difficult to remove, pry on the cover in more than one recessed location.

4. On the XT, remove the splined coupler, shifter fork, pin, and spring of the differential lock assembly and set aside. Note position of parts for assembling purposes.



XT

KX175A

5. On the XT, make match marks on the left bearing housing and differential housing; then remove the plate and account for a shim. Mark the shim as left-side.



XT

KX176A



KX177



KX178

6. Place the differential with the open side down; then lift the housing off the spider assembly. Account for shim(s) and mark as right-side.



KX179

6



KX181

7. Using the 48 mm Internal Hex Socket (p/n 0444-104), remove the lock collar securing the pinion gear assembly.

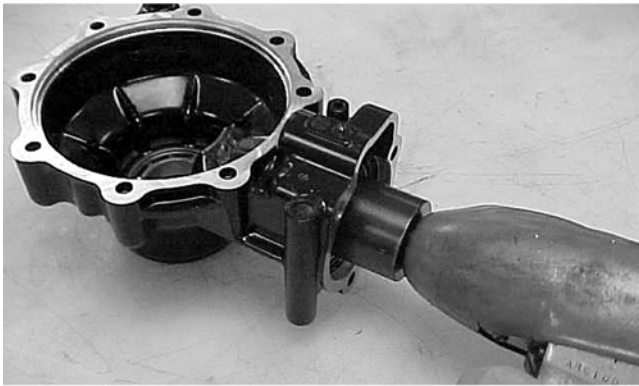

CC875

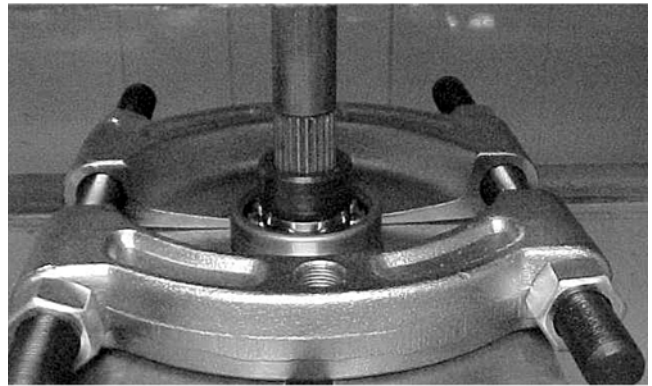

CC879



CC876

8. Using the Pinion Gear/Shaft Removal Tool (p/n 0444-127) and a hammer, remove the pinion gear from the gear case housing.

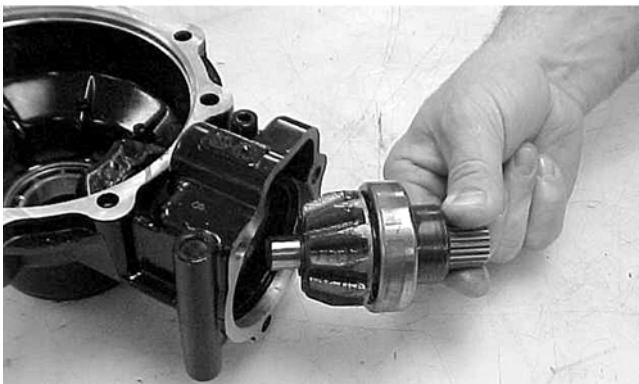

CC878

9. Secure the pinion gear in a bearing puller; then remove the pinion bearing using a press. Account for a collar and a bearing.

■ **NOTE:** If gears are being replaced, use the existing shims. The numbers are scribed onto the gears: the ring gear has the number on the opposite side of the gears, and the pinion gear has the number on the end of the pinion gear shaft by the splines. If no number is present, it should be considered as being in the 0 category.

■ **NOTE:** If the gear case housing is being replaced, proceed to the following Shimming Procedure/Shim Selection sub-section.

### **Shimming Procedure/ Shim Selection**

1. Press bearings into bores by outer ring to hard contact with seat.
2. Install the lock collar and tighten to specifications; then stake the lock collar edge approximately 1.5 mm (0.060 in.) into the lower oil channel.

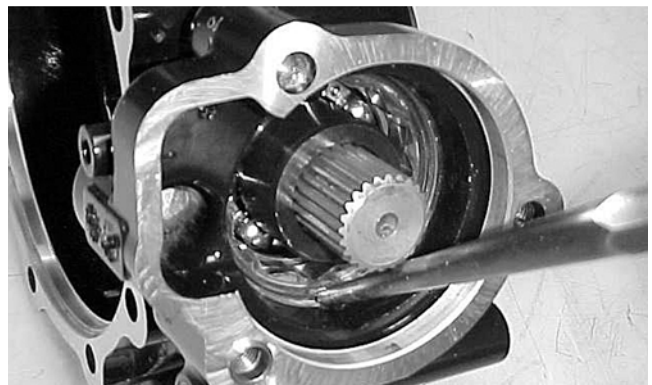

CC891

3. Note the following shim selections (shims are nominally 1.5 mm/0.060 in. thick):



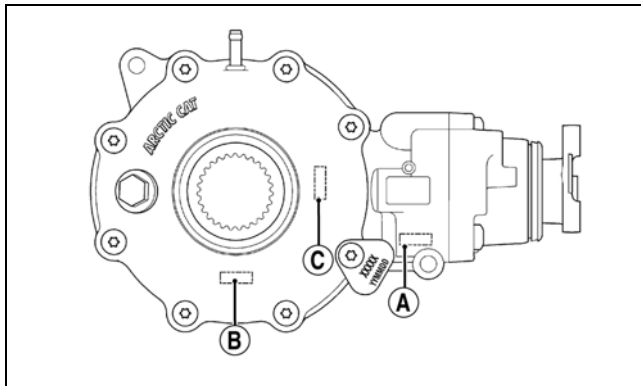

738-268B

A. Cover Side - add value A on the gear case housing to value B (XT) or value C (Prowler) on the gear case cover; then add 1.5 mm (0.060 in.). This will give you the proper shim thickness.

■ **NOTE:** When shimming a rear gear case, add value A to value B on both models.

B. Gear Case Side - install a 1.3-1.4 mm (0.050-0.055 in.) shim and tighten the bolts to 3.5-4.3 kg-m (25-31 ft-lb). Verify backlash to be within a range of 0.28-0.38 mm (0.011-0.015 in.) and end-play to be within a range of 0.10-0.20 mm (0.004-0.008 in.). If not within specification range, reselect shim until backlash specification range can be verified.

4. Prior to final assembling, apply molybdenum disulfide grease to all oil seal lips.
5. Prior to final assembling, prelubricate journal on pinion assembly with SAE 80W-90 hypoid gear lubricant prior to pressing assembly into gear case housing.

### Assembling Pinion Gear

1. Install the bearing onto the pinion shaft. Install the pinion shaft collar.

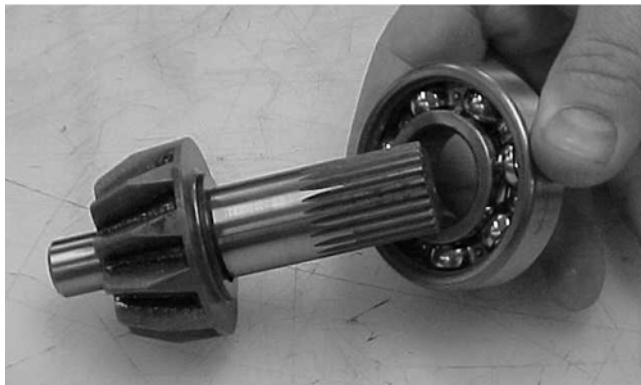

CC882

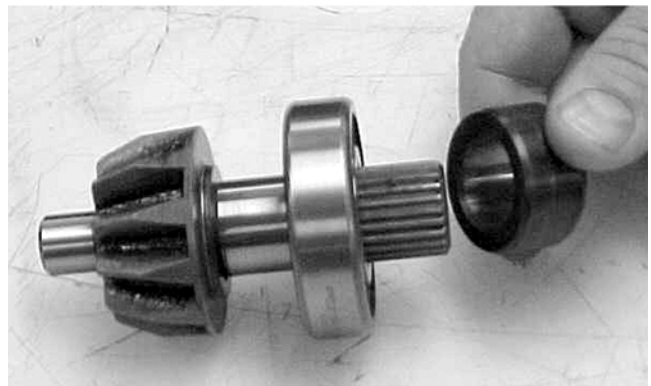

CC883

2. Place the pinion assembly in a bearing puller; then install the bearing using a press.

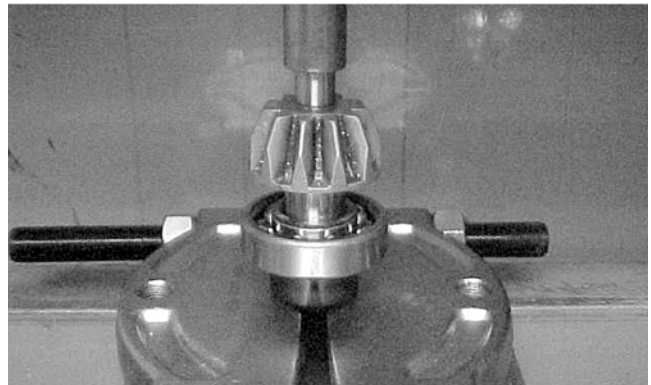

CC884

3. Install the pinion gear assembly into the housing. Using the 48 mm Internal Hex Socket (p/n 0444-104), secure the pinion gear assembly with the existing lock collar. Tighten to specifications.

■ **NOTE:** On a front differential, the lock collar has right-hand threads. On a rear gear case, the lock collar has left-hand threads.

6

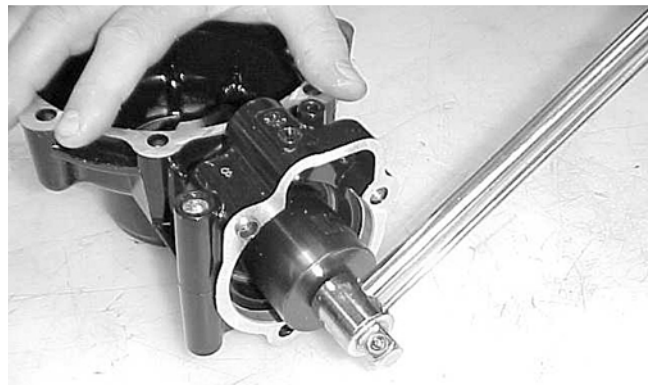

CC890

4. Place a punch on the edge of the lock collar in the oil gallery area; then using a hammer, stake the lock collar to ensure that the collar will remain securely tightened.



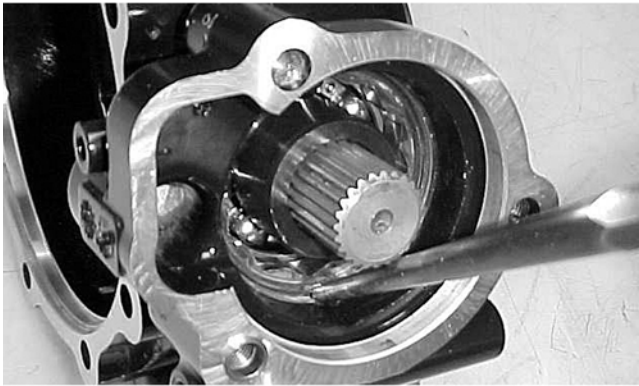

CC891

5. Install the shift fork shaft w/spring into the gear housing making sure the shaft O-ring is positioned to the inside.

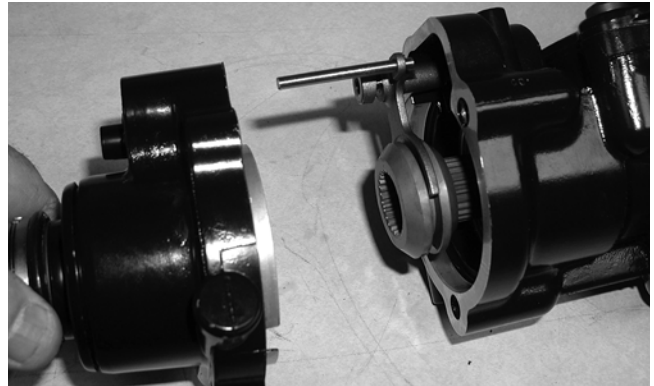

CD103

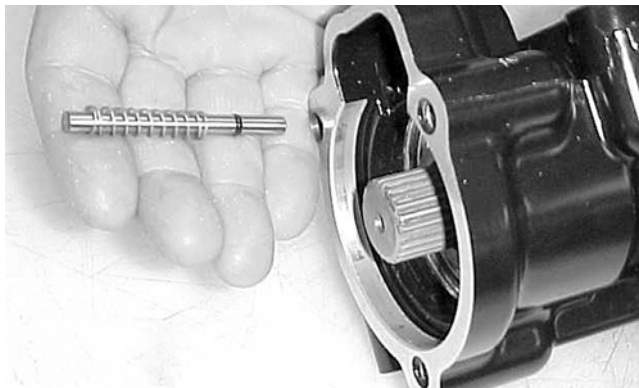

CC892

6. Install the shift fork assembly making sure the fork leg is facing upward. Apply a small amount of oil to the gasket; then install the gasket.

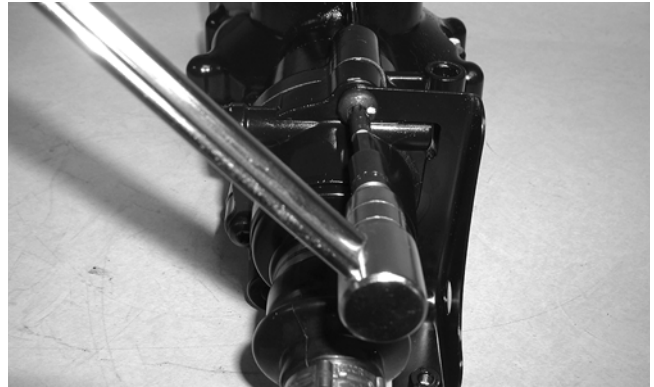

CD110

8. Install the proper shim onto the ring gear spider assembly making sure the chamfer side of the shim is facing toward the ring gear. Install the ring gear in the housing; then install the outside shim with the chamfer side of the shim toward the ring gear.

■ **NOTE:** The spider and ring gear assembly must be replaced as a complete unit.

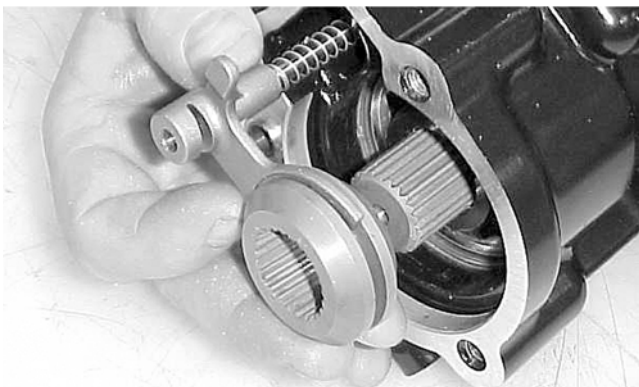

CC893

7. Place the input shaft assembly onto the gear housing; then secure with the existing cap screws. Tighten to specifications.

■ **NOTE:** If a new gear housing is being installed, tighten the cap screws to 3.5-4.3 kg-m (25-31 ft-lb).



KX178

9. On the XT, install the left bearing housing aligning the match mark to the mark on the differential housing.



KX177

10. On the XT, install the differential lock assembly into the bearing housing; then place the O-ring on the gear case housing.



KX175A



KX174A

11. Making sure the O-ring is properly positioned on the gear case housing, install the housing with existing hardware. Account for the ID tag. Tighten the cap screws to specifications.

■ **NOTE:** Grease can be applied to the O-ring for ease of assembling.

■ **NOTE:** If a new gear case housing is being installed, tighten the cap screws to 3.5-4.3 kg-m (25-31 ft-lb).

## Removing Needle Bearing

■ **NOTE:** Removing the needle bearing is rarely necessary. Avoid removing the needle bearing unless the bearing is clearly damaged.

■ **NOTE:** This procedure can be performed on a rear gear case.

1. Place a 6.35 mm (1/4 in.) drill bit on the inside surface of the needle bearing (against the bottom side); then drill through the pinion shaft needle bearing housing.

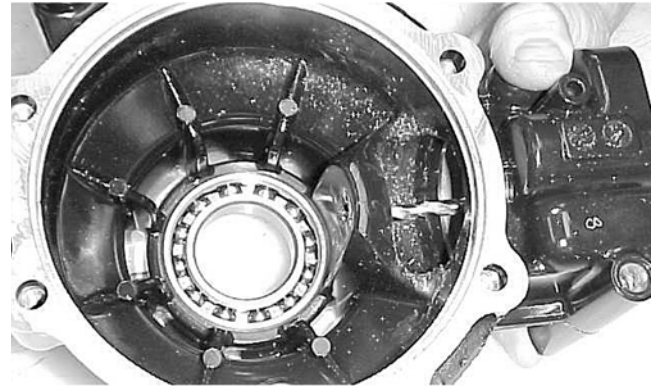

CC885

2. Using a propane torch, heat the area surrounding the needle bearing to soften the Loctite.

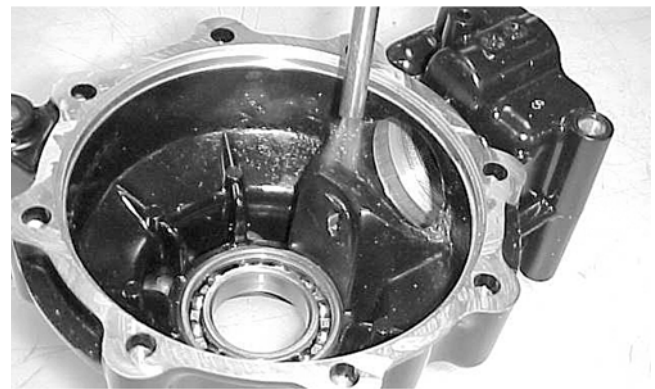

CC886

3. Using a flat-nosed punch, drive the bearing out of the housing.



CC887



## Installing Needle Bearing

1. Apply red Loctite #271 to the outside of a new bearing; then place the new bearing into the housing.

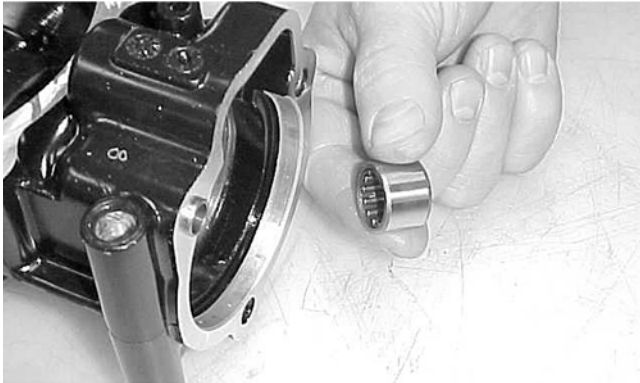

CC888

2. Using a suitable driver, install the needle bearing into the gear case housing making sure the bearing is seated.

■ **NOTE:** Do not push the bearing too far into the housing.

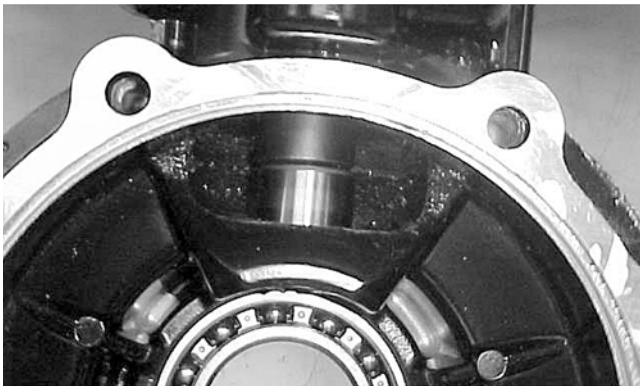

CC889

3. Install the pinion shaft and secure with the existing 48 mm lock collar. Tighten to specifications.

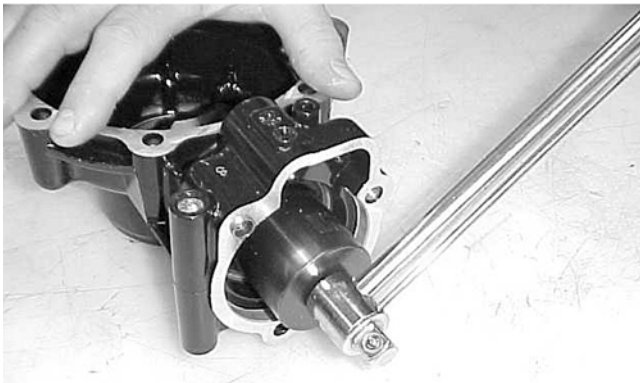

CC890

4. Place a punch on the edge of the lock collar in the oil gallery area; then using a hammer, stake the lock collar to ensure that the collar will remain securely tightened.

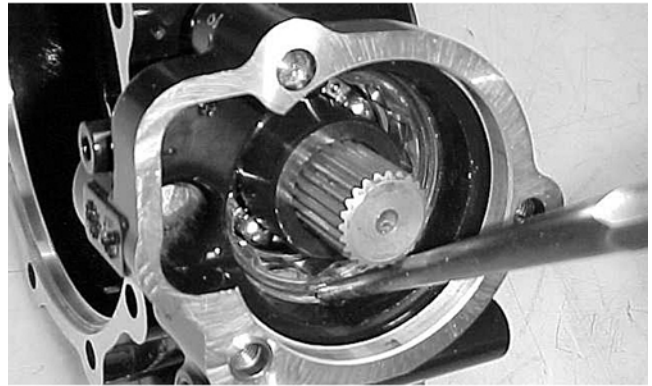

CC891

5. Install the pinion housing.

## Removing/Installing Axle Seal

■ **NOTE:** This procedure can be performed on a rear gear case.

1. Remove the seal using a seal removal tool.



CC899

2. Using a press, remove the bearing.



CC900

3. Using a press, install the new bearing into the housing.



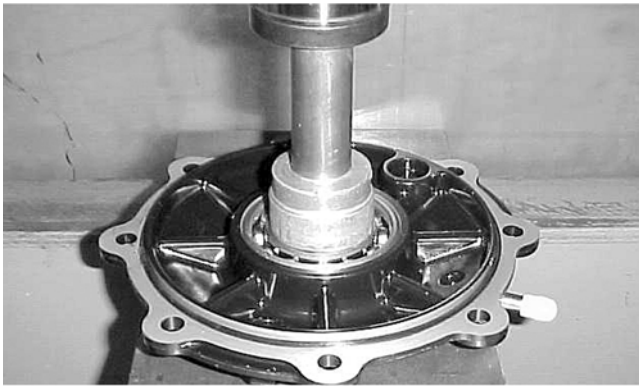

CC901

■ **NOTE:** Prior to installing the seal, apply grease to the seal outside diameter.

4. Install the seal into the housing pressing evenly on the outside edge until the seal is seated.

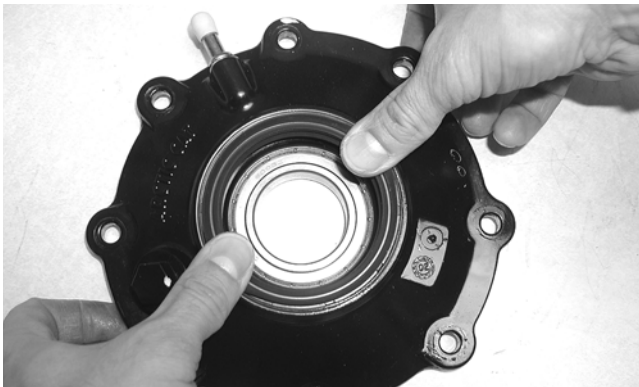

CD018

5. Repeat steps 1-4 for the opposite side.

## INSTALLING DIFFERENTIAL

1. Place the differential assembly into position in the frame; then install the top mounting through-bolt, two washers, and lock nut. Do not tighten at this time.
2. Install the lower front mounting through-bolt, washers, spacers, and lock nut. Note the correct location for the spacer washers.

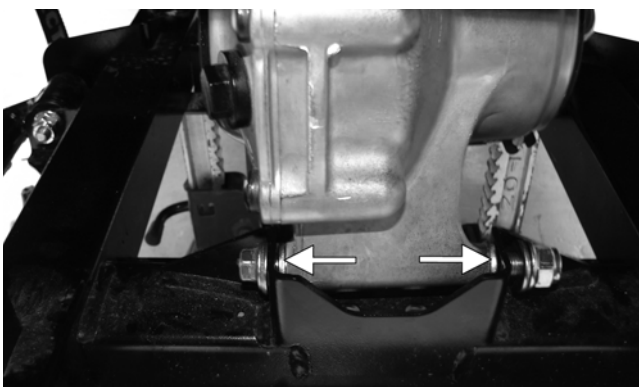

PR205A

3. Tighten the nuts to specifications.

4. Pour 275 ml (9.3 fl oz) of SAE 80W-90 hypoid lubricant into the differential and install the fill/level plug. Tighten to specifications.
5. Align the scribed match marks on the front input drive flange and the front drive yoke flange; then secure with the three cap screws tightened to specifications.

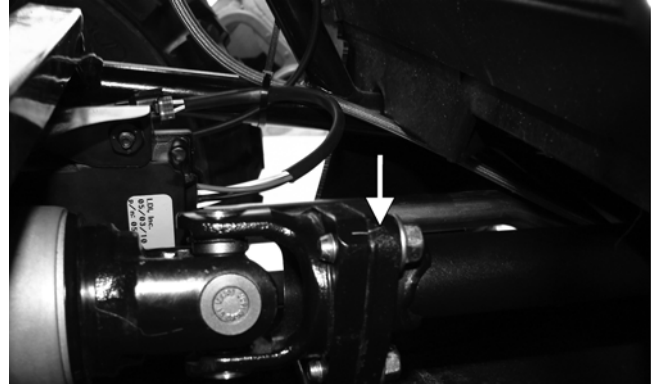

PR198A

6. Install the front axles (see Drive Axles in this section).
7. Install the knuckle assemblies onto the axles and ball joints; then secure with four cap screws taking care not to damage the threads when installing. Tighten to specifications.

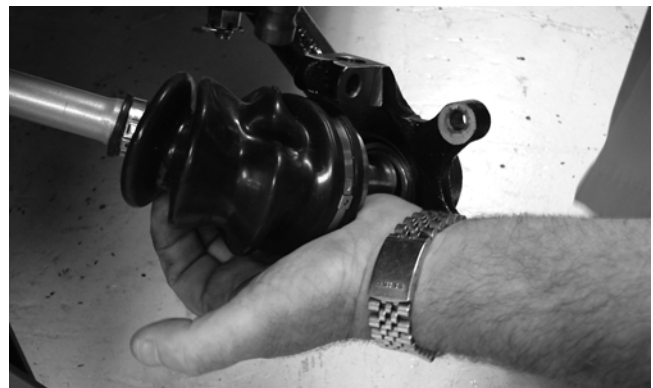

PR201

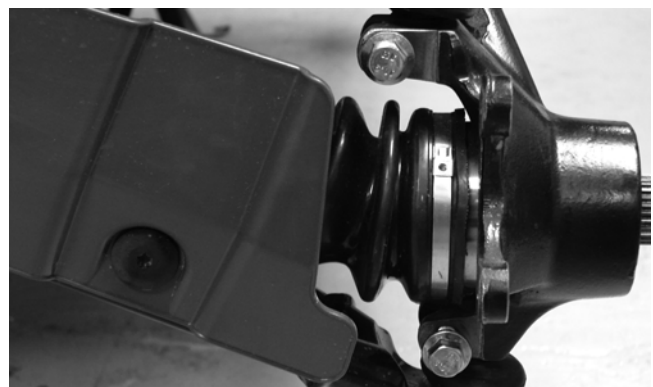

PR193

8. Secure the lower shock eyelets with cap screws and lock nuts. Tighten to specifications.

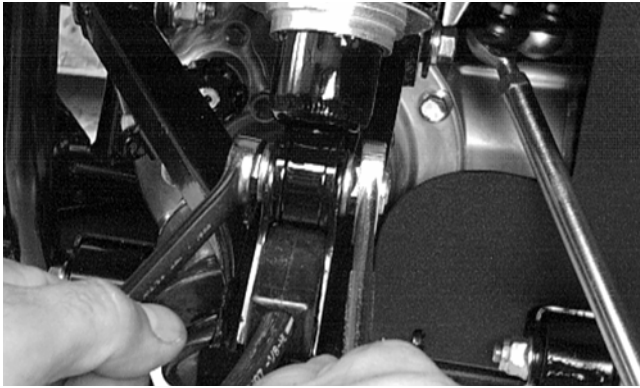

AF897D

9. Install the brake calipers. Secure with the cap screws tightened to specifications.
10. On the XT, install the differential lock cable support making sure to connect the cable end in the actuator plunger; then secure with two torx-head cap screws and tighten to specifications.

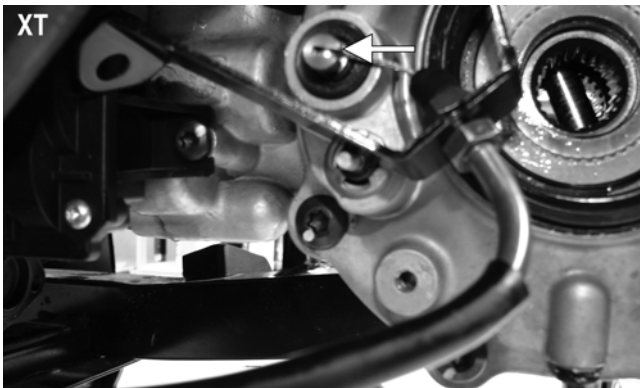

PR194B

11. Connect the front drive actuator connector to the main harness and the differential lock indicator connector to the differential; then secure the wires to the frame with nylon ties.
12. Apply a light coat of multi-purpose grease to the hub splines; then install the hubs and nuts. Tighten to specifications; then install new cotter pins.

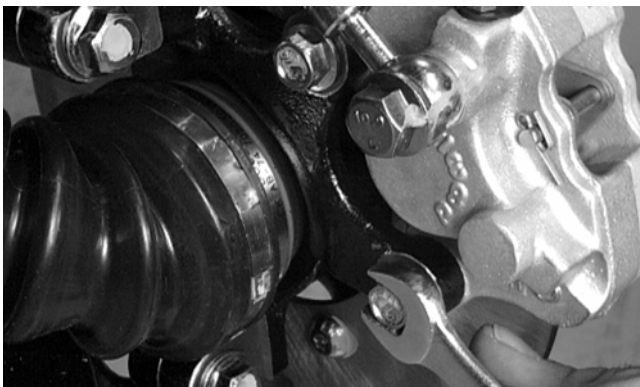

AF894D

13. Install the wheels and tighten to specifications.

14. Remove the vehicle from the support stand.
15. Install the belly panel.

---

## Drive Axles

---

### REMOVING REAR DRIVE AXLE

1. Secure the vehicle on a support stand to elevate the wheels.

#### **WARNING**

**Make sure the vehicle is solidly supported on the support stand to avoid injury.**

2. Set the parking brake; then remove the wheels.
3. Remove the cotter pins securing the hex nuts; then remove the hex nuts.

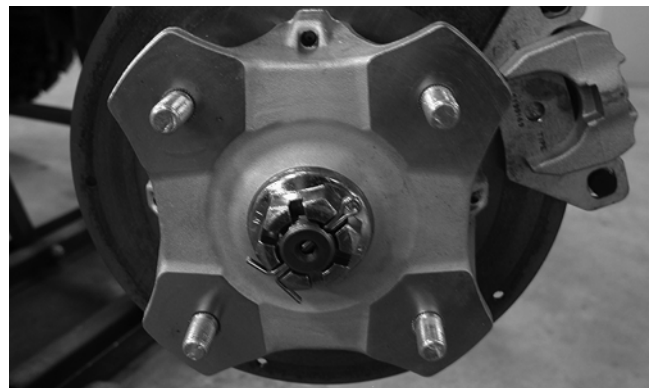

KX041

4. Slide the hub out of the knuckle and set aside.



PR221

5. Remove the cap screw and lock nut securing the knuckle to the upper A-arm. Discard the lock nut.



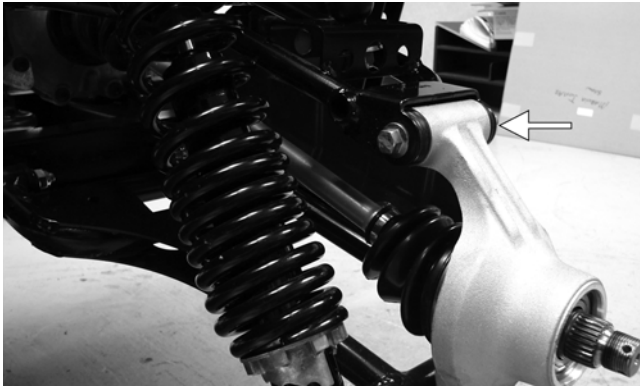

PR220A

■ **NOTE:** Never reuse a lock nut. Once a lock nut has been removed, it must be replaced with a new lock nut.

6. While holding the drive axle stationary, pull the top of the knuckle out and down until it is free of the drive axle.



PR218

7. Place a drain pan under the vehicle to contain any oil leakage; then using a slide hammer, remove the drive axle.



AF935

## REMOVING FRONT DRIVE AXLE

■ **NOTE:** For removing a front drive axle, see Front Differential in this section.

## CLEANING AND INSPECTING

■ **NOTE:** Always clean and inspect the drive axle components to determine if any service or replacement is necessary.

1. Using a clean towel, wipe away any oil or grease from the axle components.



CD019

2. Inspect boots for any tears, cracks, or deterioration.

■ **NOTE:** If a boot is damaged in any way, it must be replaced with a boot kit.

## DISASSEMBLING AXLES

1. Using a side-cutters (or suitable substitute), remove the large clamp from the boot.



CD020

2. Wipe away excess grease to access the retaining ring. Using an awl or circlip pliers, remove the circlip.

6



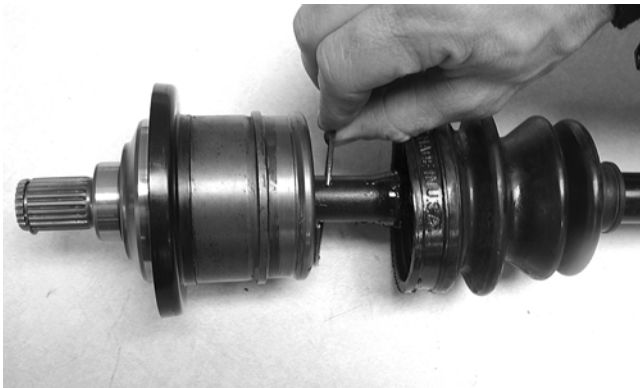

CD021

- Using a snap ring pliers, remove the circlip securing the bearing ring to the shaft. Note the direction of the bearing for assembling purposes.

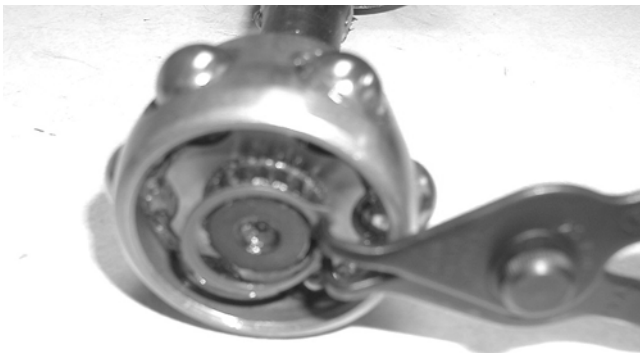

CD023

- Note the difference inside each bearing ring end for assembling purposes; then remove the bearing ring.

■ **NOTE:** The recess of the bearing must face toward the housing.



CD022

- Inspect the splines of the shaft, the bearing ring, and the housing for damage.

■ **NOTE:** If any damage is apparent to the splines, the bearing ring, and/or the housing, the drive axle must be replaced as an assembly.

- Using a side-cutters (or suitable substitute), remove the small clamp from the shaft.



CD752

■ **NOTE:** At this point if the outside boot is damaged, continue with step 7.

- Using a side-cutters (or suitable substitute), remove both outside boot clamps from the shaft. Note the position of the different-sized clamps for assembling purposes.

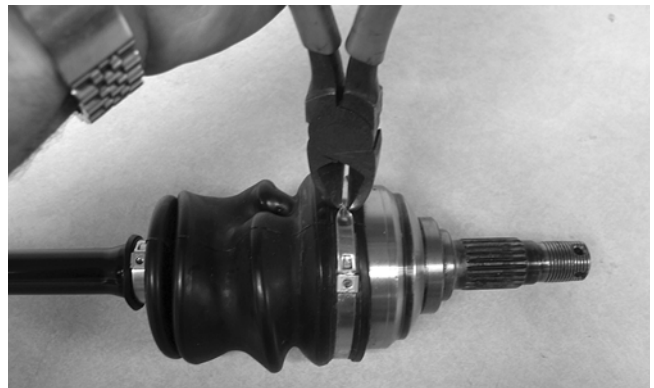

CD751

- Apply 40 grams (1/3 of contents) of grease from the grease pack included in Front Axle Boot Repair Kit (p/n 0436-276) into the knuckles and the new outside boot.

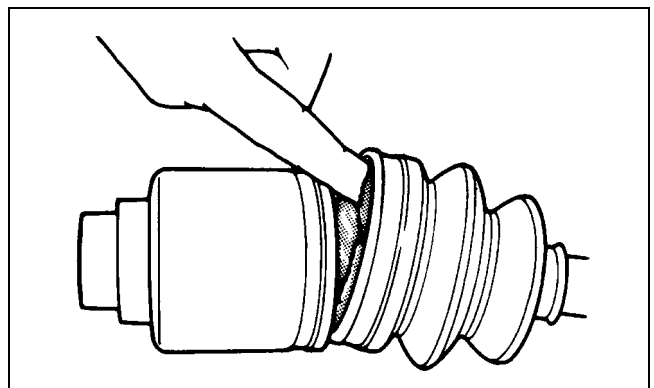

ATV-1052

■ **NOTE:** The grease pack contains 120 grams of grease. The inside joint (double-offset) requires approximately 70-90 grams of grease and the outside (bell-type) requires approximately 35-55 grams. When replacing boots, use 2/3 of the pack for inside boots and 1/3 of the pack for outside boots.

**CAUTION**  
Do no over-fill the joint as boot damage may occur resulting in joint failure.

9. Slide the new outside boot onto the shaft with the new clamps positioned as shown. Note the different-sized clamps from removal.

■ **NOTE:** The boot is positioned correctly when the small end of the boot seats down into the recessed groove.



CD754

10. Using CV Boot Clamp Tool (p/n 0444-120), secure both outside boot clamps.

**CAUTION**  
It is important that the clamps are positioned correctly or they may loosen when in motion.



CD024

## ASSEMBLING AXLES

1. Install the inner boot with the small clamp making sure the ends of the clamp are positioned correctly.

■ **NOTE:** The boot is positioned correctly when the small end of the boot seats down into the recessed groove.



CD754

2. Using the boot clamp tool, secure the small clamp of the inner boot.

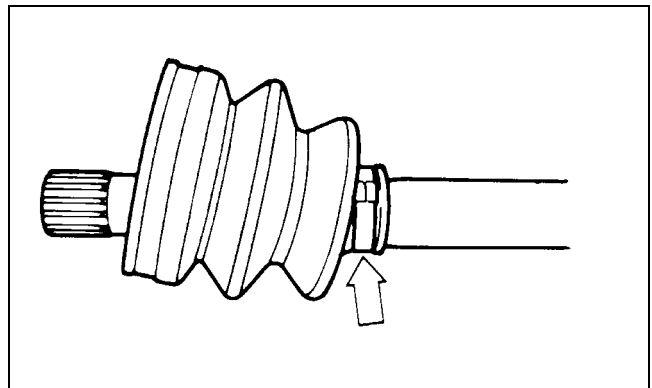

ATV-1048

3. Apply 80 grams (2/3 of contents) of grease from the pack into the bearing housing.

4. Install the bearing onto the shaft making sure the recess of the bearing is facing the housing.



CD022

**⚠ CAUTION**

The bearing ring must go onto the shaft with the side without splines facing toward the small clamp of the inner boot or severe damage will result.

5. Secure the bearing ring with the circlip making sure the sharp side of the circlip faces away from the boot.

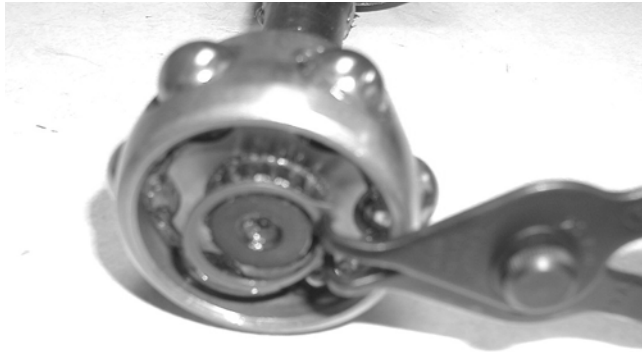

CD023

6. Making sure the marks made during disassembling align, slide the housing over the bearing ring; then completely seat the bearing ring into the housing and install the circlip.

■ **NOTE:** Pull the bearing ring out of the housing until it contacts the circlip; then slide the ring in half way. This will purge air from the housing and ensure the bearing is packed properly.

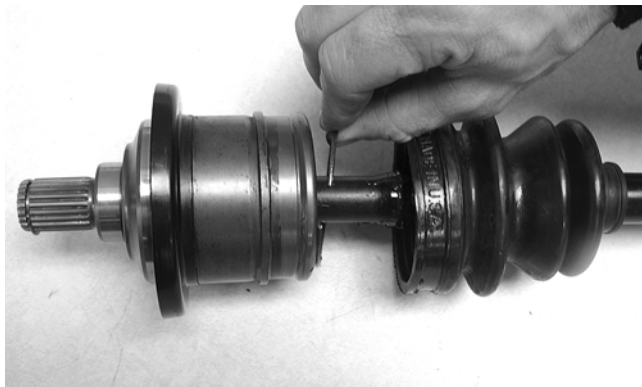

CD021

7. Slide the boot over the housing; then using the boot clamp pliers, secure the boot with the clamp.



CD024

8. Inspect the axle components for correct positioning of the four clamps. Also, inspect the boots for being correctly positioned on the shaft.

### INSTALLING REAR DRIVE AXLE

1. Slide the drive axle into place in the gear case.

■ **NOTE:** To assure proper seating of the axle, give it a light pull; the axle should remain "clipped" in place.

2. Swing the knuckle up and onto the drive axle; then place the knuckle into place in the upper A-arm. Secure the knuckle to the A-arm with a cap screw and a new lock nut. Tighten to specifications.
3. Place the hub into position on the axle followed by a hex nut. Tighten the hex nut finger-tight at this time.
4. Tighten the hub hex nut (from step 3) to specifications; then install and spread a new cotter pin making sure each side of the pin is flush to the hub nut.

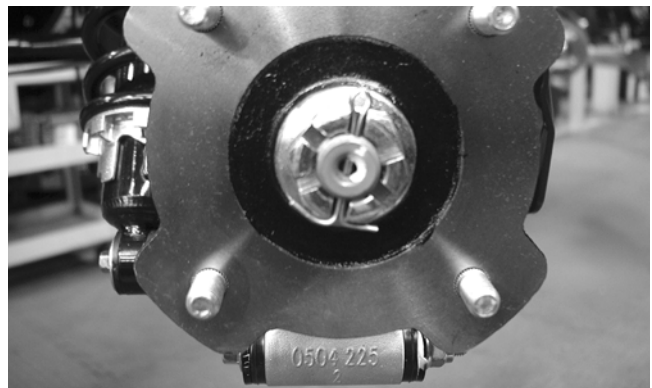

CD027

5. Install the wheel. Tighten to specifications.
6. Remove the vehicle from the support stand and release the parking brake.



## INSTALLING FRONT DRIVE AXLE

1. Position the drive axle in the gear case and steering knuckle; then insert the ball joints into the steering knuckles. Secure with cap screws tightened to specifications.
2. Secure the lower shock eyelet to the A-arm with a cap screw and a new lock nut. Tighten to specifications.
3. Slide the hub w/brake disc into position in the steering knuckle followed by a hex nut. Tighten finger-tight at this time.
4. Install the brake caliper on the steering knuckle. Tighten to specifications.
5. Set the parking brake; then turn the ignition switch to the ON position, select 4WD on the 2WD/4WD drive selector switch, and engage the differential lock. Turn the ignition switch to the OFF position.
6. Tighten the hub hex nut (from step 3) to specifications; then install and spread a new cotter pin making sure each side of the pin is flush to the hub nut.

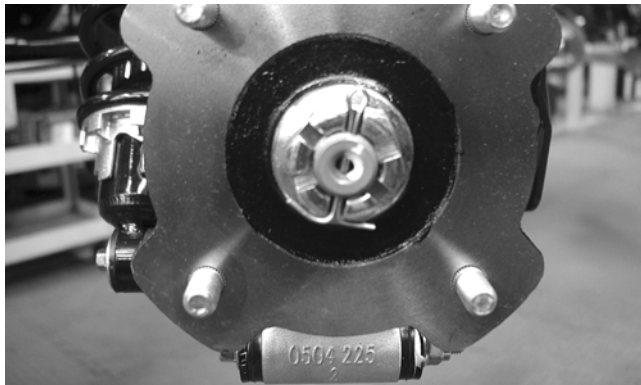

7. Install the wheel and tighten to specifications.
8. Remove the vehicle from the support stand.
9. Check the front differential lubricant level and add lubricant as necessary.

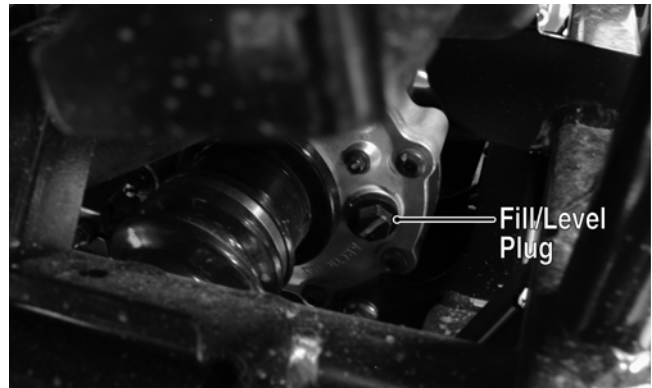

PR065A

## Rear Gear Case

### REMOVING

■ **NOTE:** Release the cargo box latch and allow the cargo box to tilt back; then remove the cargo box lift support by removing the cap screw and nut securing the lower lift support to the frame. The cargo box will tilt fully rearward.

1. Remove both of the rear drive axles (see Drive Axles in this section).
2. Scribe a match mark on the rear input drive flange and the rear input yoke flange; then remove three cap screws securing the flanges together.

6

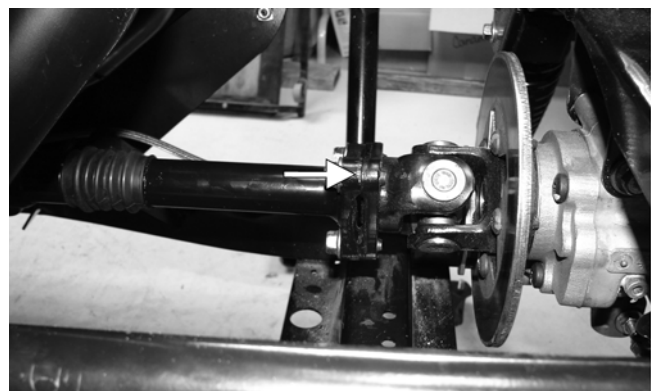

PR211A

3. Remove the drive-line brake caliper.
4. Remove the two cap screws and lock nuts securing the rear gear case to the frame; then remove the gear case through the upper left-side of the frame and lift out the top.

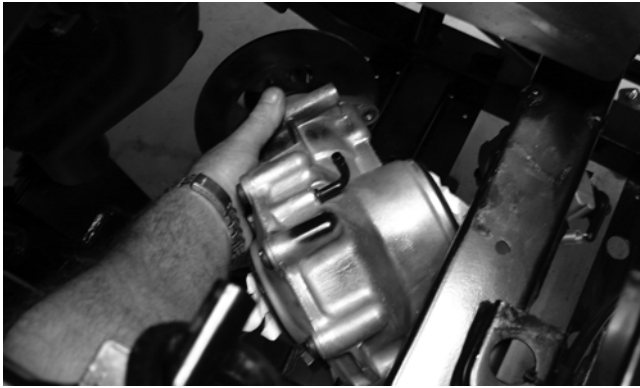

PR207

**AT THIS POINT**

For servicing the input shaft, pinion gear, needle bearing, and axle seal, see Front Differential in this section.

**INSTALLING**

1. Slide the gear case into position down through the upper-left side of the frame; then secure it to the frame with cap screws and lock nuts. Tighten to specifications.

■ **NOTE:** If a new gear case is being installed, tighten the cap screws to 5.1-6.3 kg-m (37-45.5 ft-lb).

2. Align the scribed match marks on the rear input drive coupler flange and the rear input yoke flange; then install three cap screws and tighten to specifications.

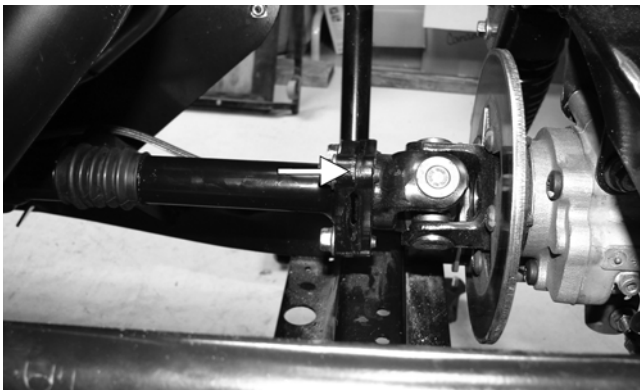

PR211A

3. Install the rear drive axles (see Drive Axles in this section).
4. Install the drive-line brake caliper and tighten the mounting cap screws to specifications; then adjust the parking brake (see Parking Brake in Section 2).

**Hub**

**REMOVING**

1. Secure the vehicle on a support stand to elevate the wheel; then remove the wheel.

■ **NOTE:** Removing or tightening of the hub nuts requires that the axles be locked. To lock the rear axle, set the parking brake. To lock the front axle, turn the ignition switch to ON, select 4WD on the 2WD/4WD drive selector switch, and engage the differential lock; then set the parking brake and turn the ignition switch to OFF.

**WARNING**

Make sure the vehicle is solidly supported on the support stand to avoid injury.

2. Remove the cotter pin from the axle.

■ **NOTE:** During assembly, new cotter pins should be installed.

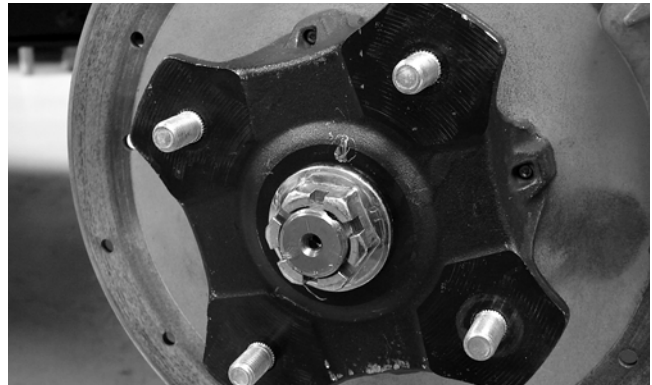

PR257

3. Remove the flange nut securing the hub.
4. Remove the brake caliper (front only).

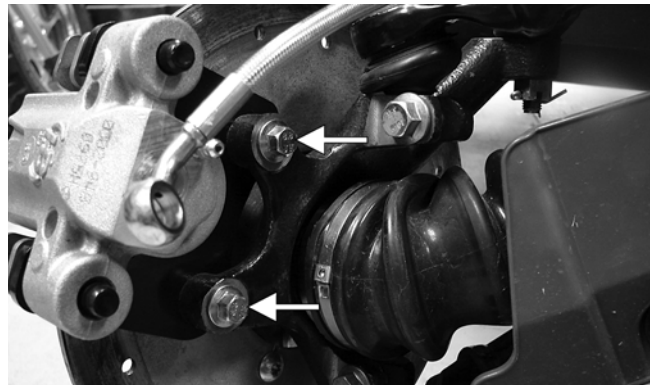

PR243A

5. Remove the hub assembly.

6. Remove the four cap screws securing the brake disc (front hub only).

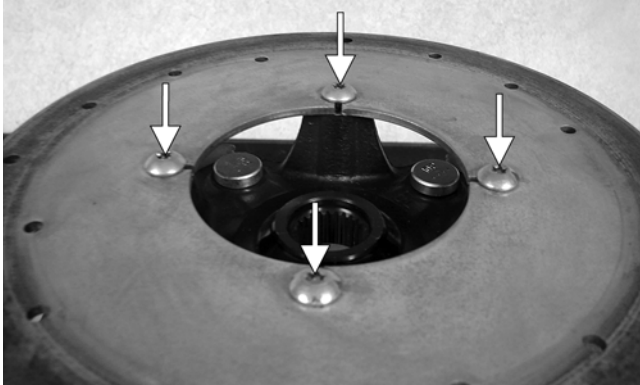

PR254A

## CLEANING AND INSPECTING

■ **NOTE:** Whenever a part is worn excessively, cracked, or damaged in any way, replacement is necessary.

1. Clean all hub components.
2. Inspect all threads for stripping or damage.
3. Inspect the brake disc (if applicable) for cracks or warping.
4. Inspect the hub for pits, cracks, loose studs, or spline wear.

## REPLACING WHEEL STUDS

To replace wheel studs, use the following procedure.

1. Secure the hub in a suitable holding fixture and remove the brake disc (if applicable).
2. Drive the damaged stud out of the hub; then place the new stud into the hub and thread on an appropriate flange nut.

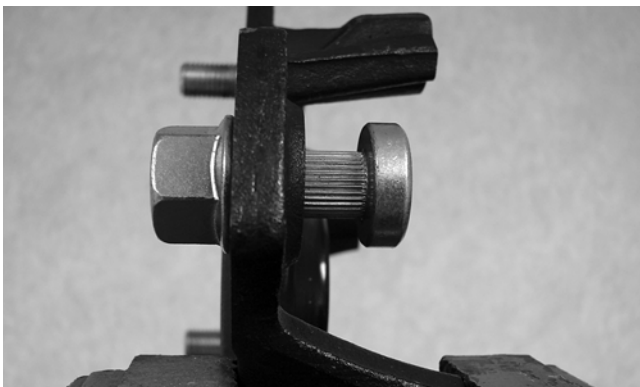

PR250

3. Using a socket and ratchet handle, tighten the nut until the stud is fully drawn into the hub.

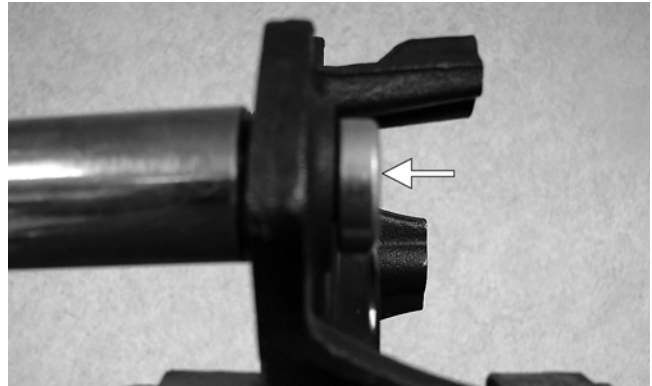

PR252A

## INSTALLING

1. Secure the brake disc (if applicable) to the hub with the four cap screws coated with red Loctite #271. Tighten to specifications.
2. Apply grease to the splines in the hub.

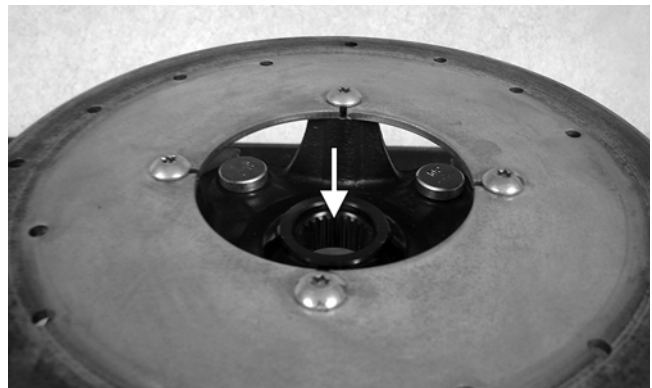

PR254B

3. Install the hub assembly onto the axle; then set the parking brake.



PR221

4. Secure the hub assembly with the nut. Tighten to specifications; then secure with a new cotter pin.

6



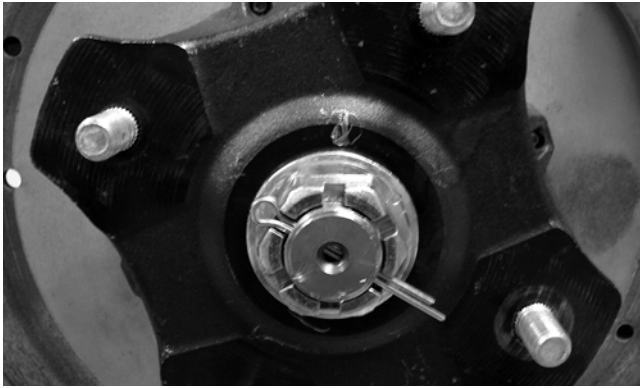

PR258

5. For front hubs, secure the brake calipers to the knuckle with two cap screws tightened to specifications.

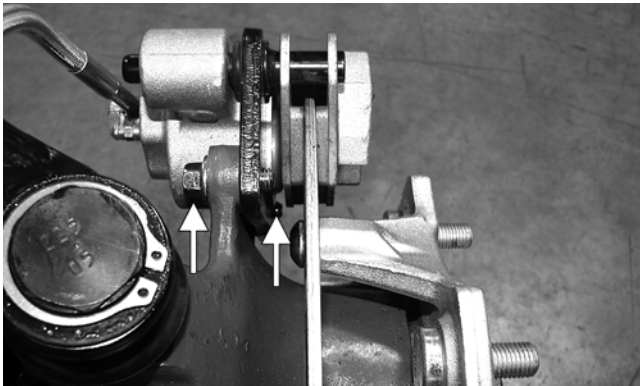

PR377B

6. Install the wheel and tighten to specifications.
7. Remove the vehicle from the support stand.

---

## Hydraulic Brake Caliper

---

■ **NOTE:** The brake caliper is a non-serviceable component; it must be replaced as an assembly.

### REMOVING/DISASSEMBLING

1. Secure the vehicle on a support stand to elevate the wheel; then remove the wheel.

#### **WARNING**

**Make sure the vehicle is solidly supported on the support stand to avoid injury.**

2. Drain the brake fluid from the caliper, hose, and master cylinder.

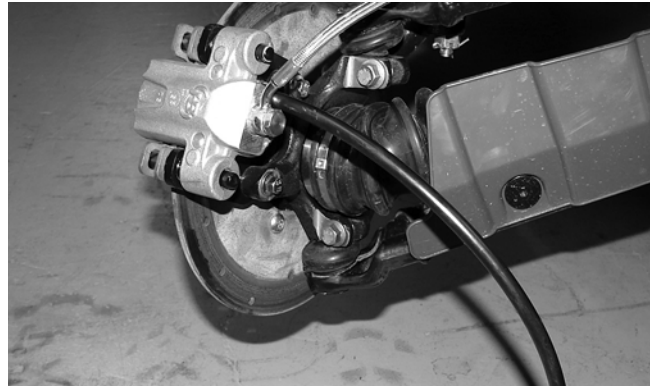

PR235

#### **CAUTION**

**Brake fluid is highly corrosive. Do not spill brake fluid on any surface of the vehicle and do not reuse brake fluid.**

3. Remove the brake hose from the caliper; then remove the caliper and plug the brake fluid port.
4. Compress the caliper holder against the caliper and remove the outer brake pad; then remove the inner brake pad.



PR237



PR238

5. Remove the caliper holder from the caliper and account for the brake caliper O-ring. Do not remove the piston from the caliper.

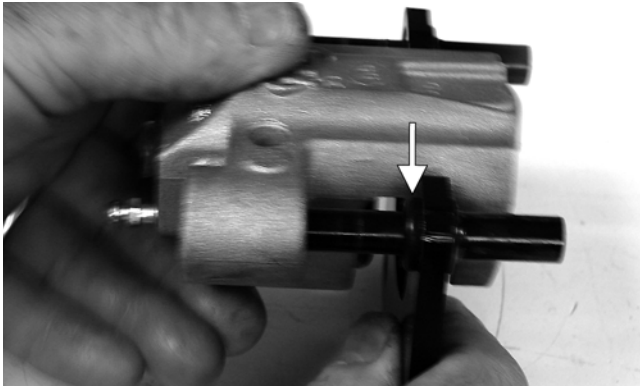

PR239B

6. Plug the fluid port with a suitable plug to prevent contamination during cleaning.

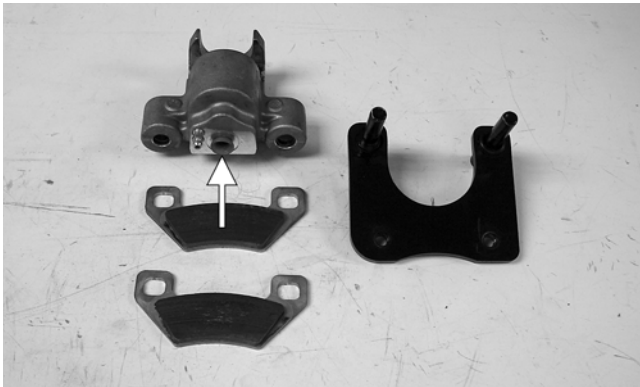

PR240A

## CLEANING AND INSPECTING

1. Clean all caliper components (except the brake pads) with parts-cleaning solvent.
2. Inspect the brake pads for damage and excessive wear.

■ **NOTE:** For measuring brake pads, see Section 2.

## ASSEMBLING/INSTALLING

1. Install the caliper onto the caliper holder making sure the caliper is correctly oriented on the holder.

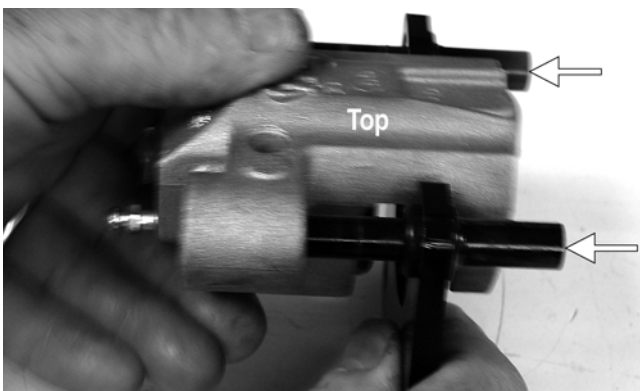

PR239C

2. Compress the caliper holder toward the caliper and install the inner brake pad; then install the outer pad.



PR238

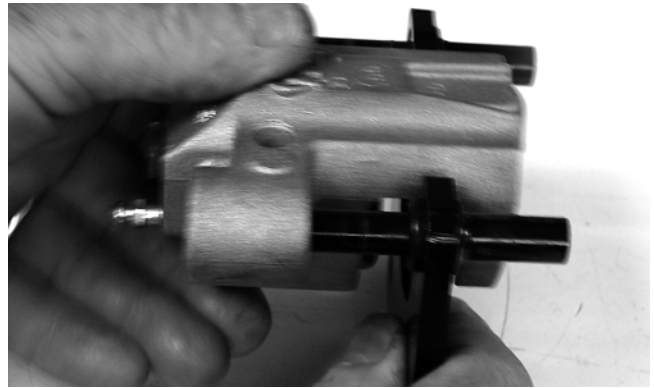

PR239

3. Place the brake caliper assembly into position and secure with the cap screws. Tighten the caliper to specifications.
4. Place a new crush washer on each side of the brake hose fitting and install it on the caliper. Tighten to specifications.
5. Fill the reservoir; then bleed the brake system (see Section 2).
6. Install the wheel. Tighten to specifications.
7. Remove the vehicle from the support stand and verify brake operation.

6

## Universal Joints

### REMOVING

■ **NOTE:** The four universal joints can be accessed by removing the belly panel. To remove the belly panel, see Belly Panel in Section 8.

1. Support the vehicle on suitable jack stands elevated high enough to allow working from the underside of the vehicle.
2. To aid in installing, match mark drive-line components prior to removing.



PR152A

3. Remove the cap screws securing the propeller shaft flange to the yoke flange on the appropriate drive-line; then remove the propeller shaft.

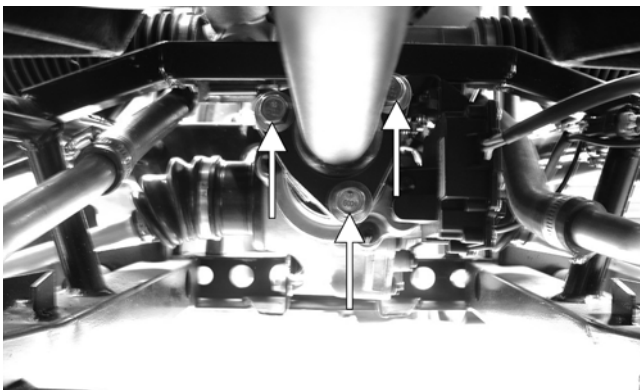

PR120A

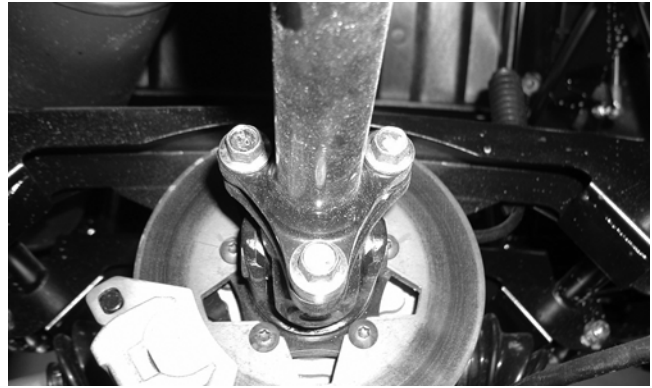

PR121

4. Install U-Joint Separator Tool (p/n 0444-128) on the universal joint fixed yoke; then remove the bearing cup retainers.

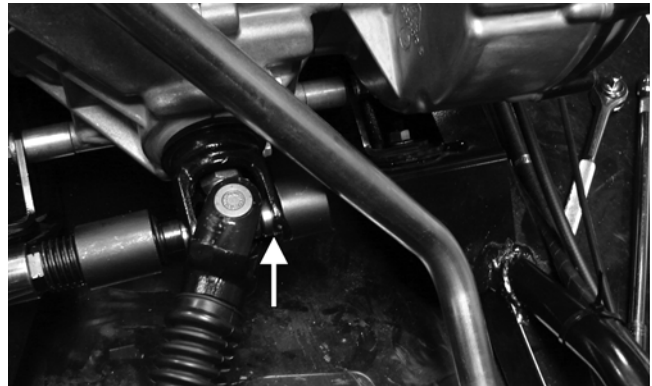

PR354A

5. Using a suitable socket and ratchet handle, rotate the jackscrew to push the bearing cup out of the yoke; then remove the tool and the bearing cup.



PR359

6. Install the separator tool on the opposite side of the yoke to push the second bearing cup from the yoke; then remove the tool and separate the universal joint.
7. Secure the separator tool in a vise and repeat steps 4-6 to remove the bearing cups from the movable yoke.



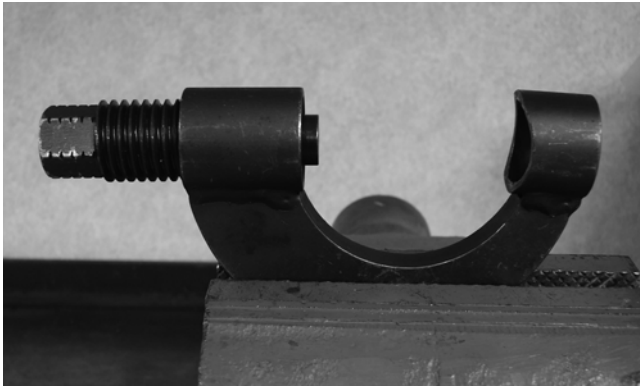

PR375



PR367C

## INSPECTING

1. Inspect the yoke bores for damage or signs of bearing cup looseness. If bearing cups are loose, the yoke must be replaced.



PR367B

2. Check that yoke legs are parallel.



PR367A

3. Check splines and flanges for excessive wear, thread damage, or warpage.

## INSTALLING

1. Remove the bearing cups from the universal joint; then insert the joint into the yoke and install one bearing cup on the joint.



PR368

2. Secure U-Joint Separator Tool (p/n 0444-128) in a vise; then place the yoke, joint, and bearing cup into position and press the cup into the yoke.



PR374

3. Install the retainer in the bearing cup; then remove the yoke from the separator tool.

■ **NOTE:** Repeat steps 2-3 for the opposite-side bearing cup.

4. Remove the separator tool from the vise and install the universal joint, bearing cups, and movable yoke into the fixed yoke using the same procedure as steps 2-3 except the vise cannot be used.

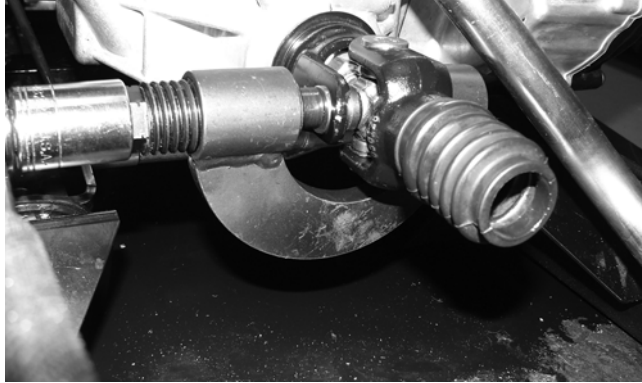

PR355

5. Check that the universal joint can be flexed freely without binding; then apply multi-purpose grease to the splines and install the propeller shaft noting the match marks made prior to removing.



PR152A

# SECTION 7 - SUSPENSION

---

---

## TABLE OF CONTENTS

---

Suspension .....	7-2
Shock Absorbers .....	7-2
Front A-Arms .....	7-3
Rear A-Arms .....	7-5
Wheels and Tires .....	7-7



---

---

## Suspension

---

■ **NOTE:** Critical torque specifications are located in Section 10.

---

---

## Shock Absorbers

---

### REMOVING

1. Secure the vehicle on a support stand to elevate the wheels and to release load on the suspension.

#### **WARNING**

**Make sure the vehicle is solidly supported on the support stand to avoid injury.**

2. Remove the two cap screws and nuts securing each front shock absorber to the frame and upper A-arm. Account for bushings and sleeves from each.



AF605D

#### **CAUTION**

**Additional support stands are necessary to support the rear axle when the shock absorbers are removed or damage may occur.**

3. Remove the two cap screws and nut securing each rear shock absorber to the frame and lower A-arm. Account for bushings and sleeves from each.



AF626D

4. Using a suitable spring compression stand, compress the shock absorber spring, remove the retainer, and remove the spring.

#### **WARNING**

**Shock absorber springs are under high compression loads. Do not attempt to remove springs without an adequate spring compressor. Severe injury could result.**



AF730D

### CLEANING AND INSPECTING

■ **NOTE:** Whenever a part is worn excessively, cracked, or damaged in any way, replacement is necessary.

1. Clean all shock absorber components in parts-cleaning solvent.
2. Inspect each shock rod for nicks, pits, rust, bends, and oily residue.
3. Inspect all springs, spring retainers, shock rods, sleeves, bushings, shock bodies, and eyelets for cracks, leaks, and bends.

### INSTALLING

1. Place the shock absorber spring over the shock absorber, compress the spring, and install the retainer.

2. Place bushings and sleeves (where appropriate) into shock eyelet; then install shock with two cap screws and nuts. Tighten all nuts to specifications.

**⚠ CAUTION**

Do not tighten the nuts beyond the 4.8 kg-m (35 ft-lb) specification or the shock eyelet or mount WILL be damaged.

■ **NOTE:** The rear shock absorber-to-lower A-arm torque factor is 2.8 kg-m (20 ft-lb).

3. Remove the vehicle from the support stand.

---

---

## Front A-Arms

---

### REMOVING

1. Secure the vehicle on a support stand to elevate the front wheels; then remove the wheels.

**⚠ WARNING**

Make sure the vehicle is solidly supported on the support stand to avoid injury.

2. Remove the cotter pin from the nut. Discard the cotter pin.



PR257

3. Remove the nut securing the hub.
4. Remove the brake caliper. Account for two cap screws.

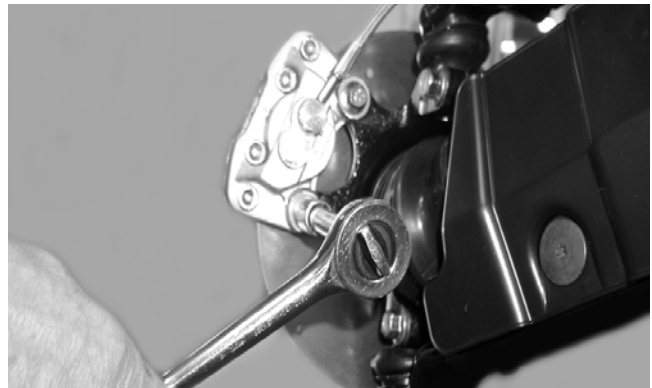

CD007

5. Remove the hub assembly.
6. Remove the cotter pin and slotted nut securing the tie rod end to the knuckle; then remove the tie rod end from the knuckle.
7. Remove the cap screws securing the ball joints to the knuckle.

**⚠ CAUTION**

Support the knuckle when removing the cap screws or damage to the threads will occur.

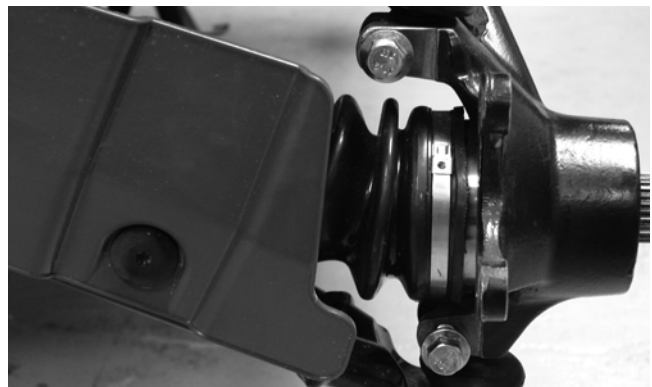

PR193

8. Tap the ball joints out of the knuckle; then remove the knuckle.
9. Remove the lower shock absorber eyelet from the upper A-arm.



AF626D

10. Remove the cap screws securing the A-arms to the frame.



AF610D

11. Remove the circlip from the ball joint; then remove the ball joint from the A-arm.



AF616D



AF616D

2. Install the A-arm assemblies into the frame mounts and secure with the cap screws. Only finger-tighten at this time.

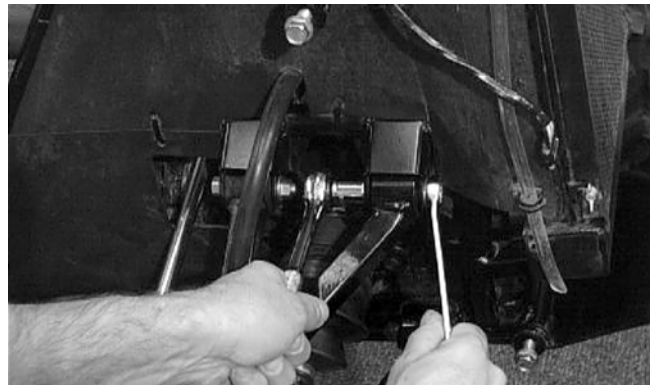

AF610D

3. Route the brake hose through the upper A-arm shock absorber mount.

## CLEANING AND INSPECTING

■ **NOTE:** Whenever a part is worn excessively, cracked, or damaged in any way, replacement is necessary.

1. Clean all A-arm components in parts-cleaning solvent.
2. Clean the ball joint mounting hole of all residual Loctite, grease, oil, or dirt for installing purposes.
3. Inspect the A-arm for bends, cracks, and worn bushings.
4. Inspect the ball joint mounting holes for cracks or damage.
5. Inspect the frame mounts for signs of damage, wear, or weldment damage.

## INSTALLING

1. Apply green Loctite #609 to the entire outside diameter of the ball joint; then install the ball joint into the A-arm and secure with the circlip.



AF627D

4. Secure the lower eyelet of the shock absorber to the upper A-arm. Tighten nut to specifications.
5. Secure the A-arm assemblies to the frame mounts (from step 2). Tighten the cap screws to specifications.

### CAUTION

Do not tighten the nut beyond the 4.8 kg-m (35 ft-lb) specification or the shock eyelet or mount WILL be damaged.



6. Install the knuckle assembly onto the ball joints and secure with cap screws. Tighten to specifications.

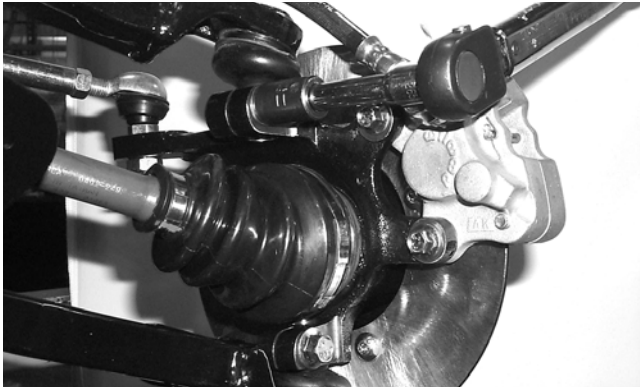

AF628D

7. Install the tie rod end and secure with the nut. Tighten to specifications; then install a new cotter pin and spread the pin to secure the nut.

■ **NOTE:** During assembly, new cotter pins should be installed.

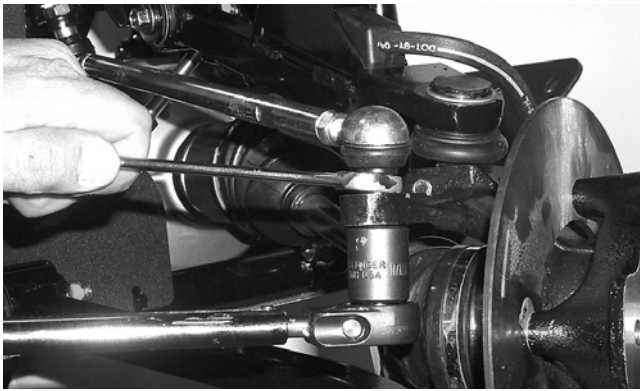

AF618D

8. Apply grease to the hub and drive axle splines; then install the hub assembly onto the drive axle.



CD009

9. Secure the hub assembly with the nut. Tighten only until snug.
10. Secure the brake caliper to the knuckle with the two cap screws. Tighten to specifications.

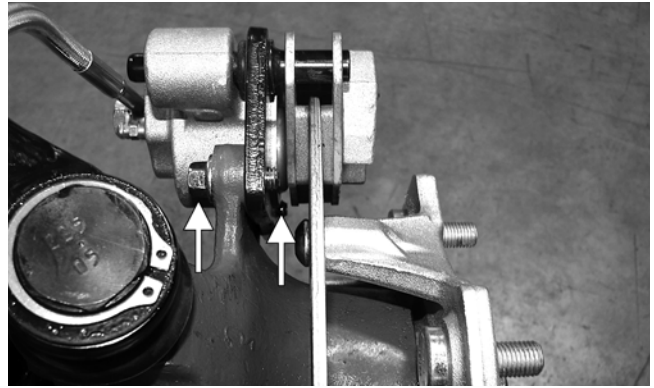

PR377B

11. Secure the hub nut (from step 9) to the shaft/axle. Tighten to specifications.
12. Install a new cotter pin and spread the pin to secure the nut.



PR260

13. Install the wheel and tighten to specifications.
14. Remove the vehicle from the support stand.

7

## Rear A-Arms

### REMOVING

1. Secure the vehicle on a support stand to elevate the wheels.

### ⚠ WARNING

Make sure the vehicle is solidly supported on the support stand to avoid injury.

2. Set the parking brake.
3. Remove the wheel.
4. Remove the cotter pin securing the hex nut; then remove the hex nut.

5. Remove the cap screws and lock nut securing the shock absorber to the frame and lower A-arm; then remove the shock absorber.
6. Remove the cap screws securing the boot guard to the lower A-arm.



AF934

7. Slide the axle out of the knuckle and set aside.
8. Remove the cap screws and lock nuts securing the knuckle to the A-arms. Discard the lock nuts.

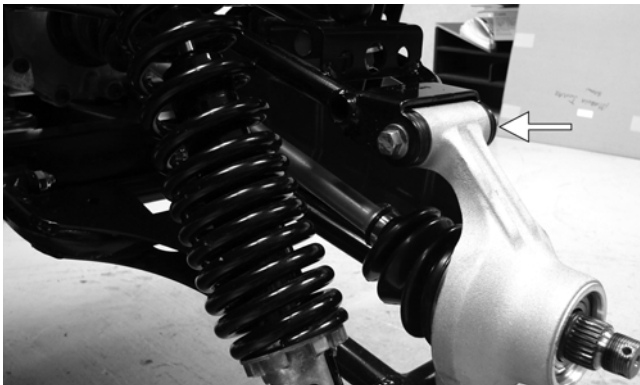

PR220A

■ **NOTE:** Never reuse a lock nut. Once a lock nut has been removed, it must be replaced with a new lock nut.

9. Remove the cap screws and lock nuts securing the A-arms to the frame; then remove the A-arms.

## CLEANING AND INSPECTING

■ **NOTE:** Whenever a part is worn excessively, cracked, or damaged in any way, replacement is necessary.

1. Clean all A-arm components in parts-cleaning solvent.
2. Inspect the A-arm for bends, cracks, and worn bushings.

3. Inspect the frame mounts for signs of damage, wear, or weldment damage.

## INSTALLING

1. Install the A-arm assemblies into the frame mounts and secure with the cap screws and new lock nuts. Finger-tighten only at this time.
2. Slide the knuckle onto the drive axle and into position on the A-arms; then secure the knuckle to the A-arms with cap screws and new lock nuts. Tighten to specifications.
3. Tighten the hardware securing the A-arms to the frame mounts (from step 1) to specifications.
4. Apply grease on the drive axle splines; then install the hub assembly onto the drive axle.



PR221

5. Secure the hub assembly with the nut. Tighten to specifications.
6. Install a new cotter pin and spread the pin to secure the nut.

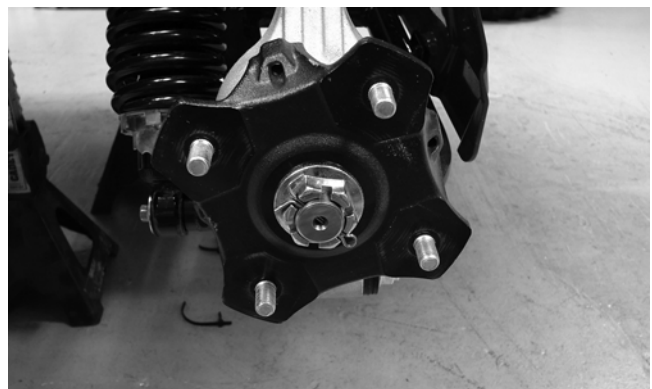

PR196

7. Secure the shock absorber to the frame with a cap screw and new lock nut. Tighten to specifications.
8. Secure the shock absorber to the lower A-arm with a cap screw and new lock nut. Tighten to specifications.

9. Secure the boot guard to the lower A-arm with the two cap screws. Tighten securely.
10. Install the wheel and tighten to specifications.
11. Remove the vehicle from the support stand.

## Wheels and Tires

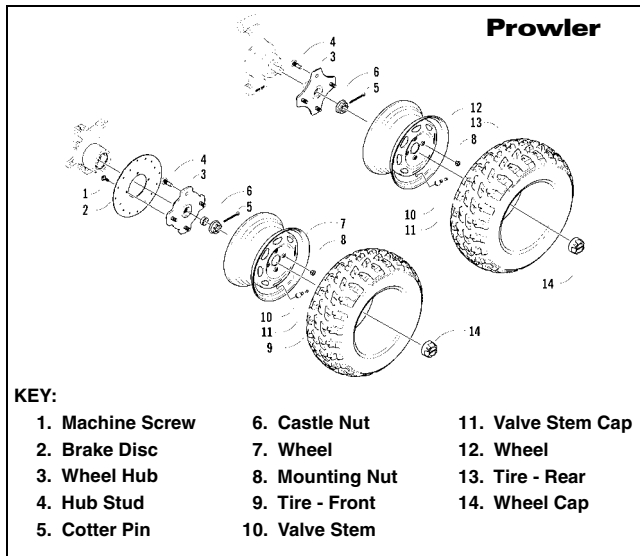

0741-724

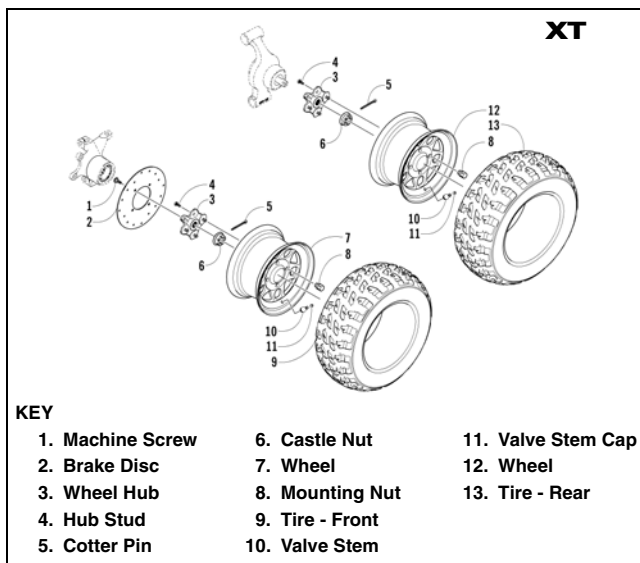

0740-489

### TIRE SIZE

#### ⚠ WARNING

**Use only Arctic Cat approved tires when replacing tires. Failure to do so could result in unstable vehicle operation.**

The Prowler/XT models are equipped with low-pressure tubeless tires of the size and type listed (see Section 1). Do not under any circumstances substitute tires of a different type or size.

#### ⚠ WARNING

**Do not mix tire tread patterns. Use the same pattern type on front and rear. Failure to heed warning could cause poor handling qualities of the vehicle and could cause excessive drive train damage not covered by warranty.**

### TIRE INFLATION PRESSURE

Front and rear tire inflation pressure should be 0.70 kg/cm<sup>2</sup> (10 psi).

### REMOVING

1. Secure the vehicle on a support stand to elevate the wheels.

#### ⚠ WARNING

**Make sure the vehicle is solidly supported on the support stand to avoid injury.**

2. Remove the wheels.

7



CD006

### CLEANING AND INSPECTING

■ **NOTE:** Whenever a part is worn excessively, cracked, or damaged in any way, replacement is necessary.

1. Clean the wheels and hubs with parts-cleaning solvent.



2. Clean the tires with soap and water.
3. Inspect each wheel for cracks, dents, or bends.
4. Inspect each tire for cuts, wear, missing lugs, and leaks.

## INSTALLING

1. Install each wheel on its hub.



2. Tighten to specifications.

## CHECKING/INFLATING

1. Using an air pressure gauge, measure the air pressure in each tire. Adjust the air pressure as necessary to meet the recommended inflation pressure.



2. Inspect the tires for damage, wear, or punctures.

### **WARNING**

Do not operate the vehicle if tire damage exists.

■ **NOTE:** If repair is needed, follow the instructions found on the tire repair kit or remove the wheel and have it repaired professionally.

■ **NOTE:** Be sure all tires are the specified size and have identical tread pattern.

3. Check the front wheel alignment (toe-in and toe-out) and adjust as necessary (see Section 8).
4. Test drive the vehicle on a dry, level surface and note any pulling to the left or right during acceleration, deceleration, and braking.

■ **NOTE:** Pulling could be caused by uneven tire pressure side-to-side, steering alignment out of adjustment, unequal loading, or improper tire size.

# SECTION 8 - STEERING/FRAME

---

---

## TABLE OF CONTENTS

---

**8**

Steering/Frame.....	8-2
Steering Assembly .....	8-2
Steering Wheel.....	8-4
Steering Wheel Shaft .....	8-4
Steering Shaft Assembly .....	8-6
Steering Knuckles .....	8-8
Checking/Adjusting Front Wheel Alignment .....	8-10
Front Bumper Assembly (XT) .....	8-11
Hood.....	8-11
Fenders .....	8-12
Floor .....	8-13
Belly Panel .....	8-13
Exhaust System .....	8-14
Cargo Box .....	8-14
Adjusting Headlights .....	8-15
Taillight Assembly.....	8-15
Seats .....	8-16

---

---

## Steering/Frame

---

■ **NOTE:** Critical torque specifications are located in Section 10.

---

---

## Steering Assembly

---

### REMOVING

1. Secure the vehicle on a support stand to elevate the front wheels; then remove the front wheels.

**⚠ WARNING**

**Make sure the vehicle is solidly supported on the support stand to avoid injury.**

2. Remove the cotter pins and nuts securing the tie rod ends to the knuckles; then remove the tie rod ends from the knuckles.



PR301

3. Make matching alignment marks on the pinion shaft and lower steering shaft joint.

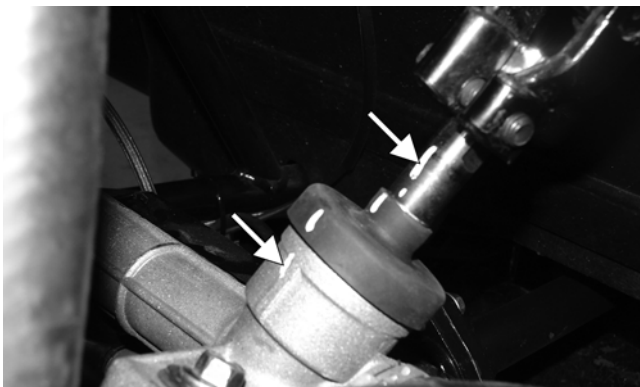

PR333A

■ **NOTE:** Any time steering components are disassembled, all connecting components should be marked for proper alignment during assembling.

4. Remove the cap screw securing the lower steering shaft joint to the pinion shaft; then slide the joint free of the pinion.



PR302

5. Remove two cap screws securing the rack and pinion assembly to the frame. Account for two nuts and two washers.

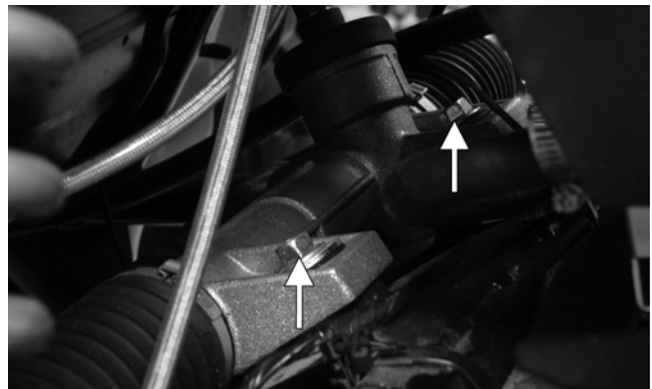

PR303A

6. Remove the rack and pinion assembly from the right-side.



PR305

### INSPECTING

■ **NOTE:** Whenever a part is worn excessively, cracked, or damaged in any way, replacement is necessary.

1. Inspect the tie rod ends for damaged threads, torn boots, or excessive wear.



2. Inspect the tie rods for bends or deformation.
3. Inspect the rack and pinion-to-tie rod boots for tears or deterioration.



PR307

4. Check boot clamps for security.
5. Check that the rack and pinion assembly operates smoothly with no binding from full-left to full-right position.
6. Inspect for grease seepage from the rack and pinion assembly.

■ **NOTE: The steering assembly is not repairable. If any of the above items fail inspection, the steering assembly must be replaced.**

## INSTALLING

1. Place the rack and pinion assembly into position from the right-side of the vehicle; then secure with the two cap screws, washers, and nuts. Tighten to specifications.



PR305

2. With the rack and the steering wheel centered, slide the lower steering shaft joint onto the pinion shaft aligning the match marks.



PR309

3. Apply green Loctite #270 to the cap screw; then secure the lower steering shaft joint to the pinion shaft making sure the shaft does not protrude into the joint beyond the clamping surface.

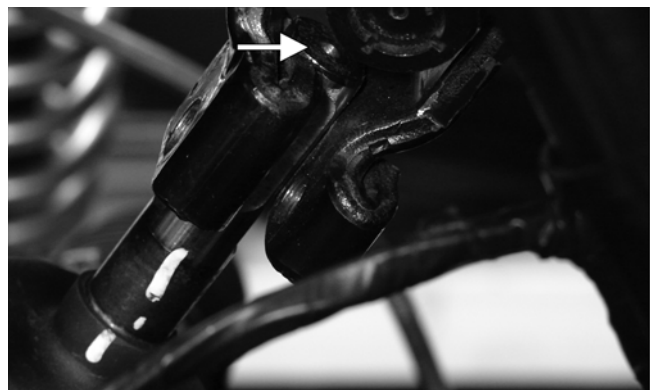

PR309A

## ⚠ WARNING

Allowing the lower steering shaft joint to extend too far onto the pinion shaft could cause binding or lock-up of the steering joint resulting in loss of steering control.

4. Tighten the cap screw to specifications; then check that the steering wheel turns freely.
5. Install the tie rod ends into the steering knuckles; then secure with the castle nuts tightened to specifications.
6. Install the cotter pins and spread to secure.

■ **NOTE: If the holes in the tie rod ends don't align with the slots in the castle nuts, tighten the nuts sufficiently to install the cotter pins.**

7. Install the wheels and check the steering system for full and free travel; then remove the vehicle from the supports.

---

---

## Steering Wheel

---

### REMOVING

1. Remove the steering wheel cover; then match mark the steering shaft and steering wheel.

■ **NOTE:** Any time steering components are disassembled, all connecting components should be marked for proper alignment during assembling.

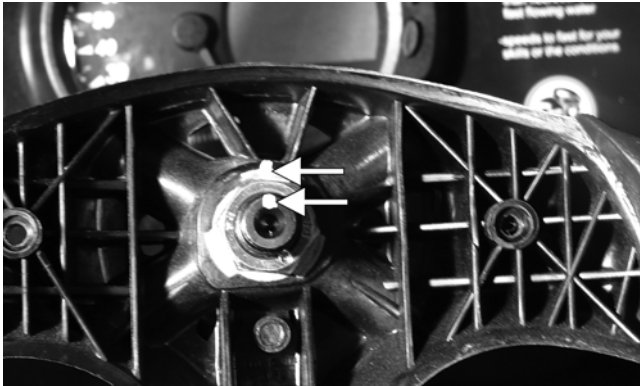

PR324A

2. Remove the nut securing the steering wheel and remove the steering wheel. Account for the flat thrust-washer and two wave washers.



PR226

### INSPECTING

1. Inspect the steering wheel for cracks, missing padding, or broken spokes.
2. Inspect the splines for wear.
3. Check that the steering wheel is not bent.

### INSTALLING

1. Place the flat thrust-washer and then the two wave washers onto the steering shaft.

2. Install the steering wheel aligning the two match marks; then apply a drop of red Loctite #271 to the threads of the nut and secure the steering wheel. Tighten to specifications.

■ **NOTE:** If a new steering wheel is being installed, mark the wheel as close as possible to the old wheel mark; then check for proper positioning with the front wheels straight forward.

3. Install the steering wheel cover and secure with the existing hardware. Do not over-tighten.

---

---

## Steering Wheel Shaft

---

### REMOVING

1. Remove the steering wheel (see Steering Wheel in this section).
2. Remove the six torx-head screws securing the dash panel to the frame and one cap screw and nut from the center support.

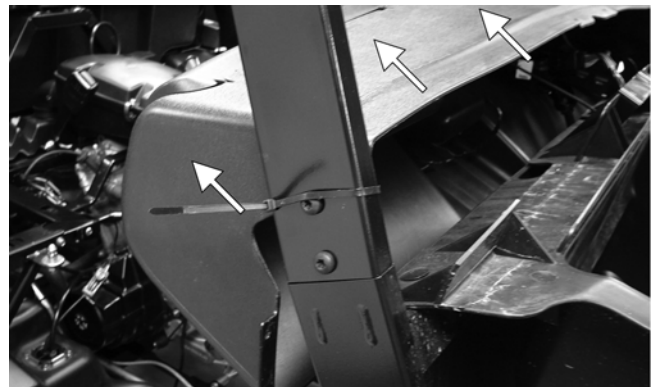

PR181A

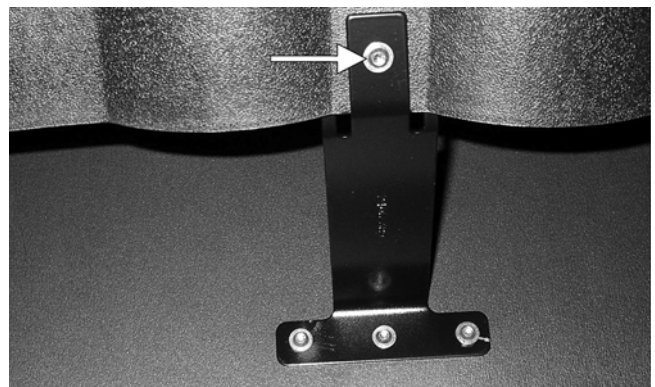

PR475A

3. Slide the dash panel rearward to access the upper steering shaft joint; then remove the cap screw securing the upper shaft joint to the steering wheel shaft.



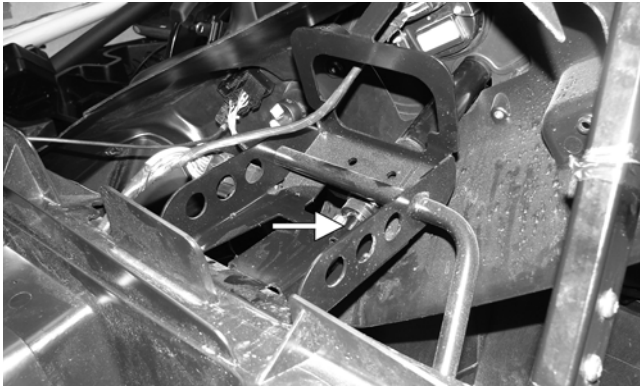

PR313A

- Match mark the upper steering shaft joint and the steering wheel shaft; then remove the steering wheel shaft. Account for the lower thrust-washer.

■ **NOTE:** Any time steering components are disassembled, all connecting components should be marked for proper alignment during assembling.

### INSPECTING

- Inspect the steering wheel shaft for excessive wear.
- Check for worn splines, cracks, or damaged threads.
- Roll the steering wheel shaft on a flat surface to check for bends.
- Inspect the nylon bushings in the steering shaft housing for cracking or excessive wear.

### INSTALLING

- Slide the steering wheel shaft into the steering housing; then with the lower thrust-washer in position, align the match marks and slide the upper steering shaft joint onto the steering wheel shaft.

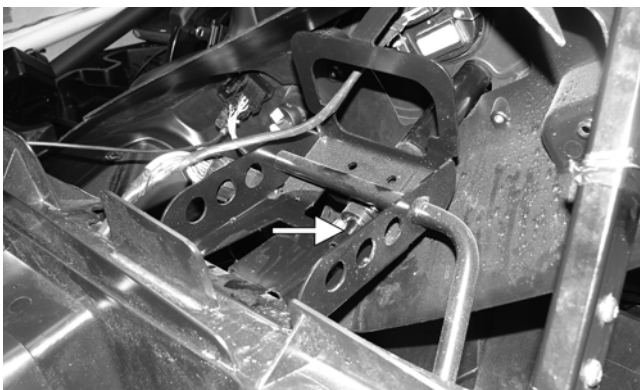

PR313A

- Apply green Loctite #270 to the cap screw; then install the cap screw in the upper steering shaft joint. Install the nut and finger-tighten.

- Align the match marks on the steering wheel shaft and the steering wheel and slide the steering wheel onto the splines; then install the nut and finger-tighten.

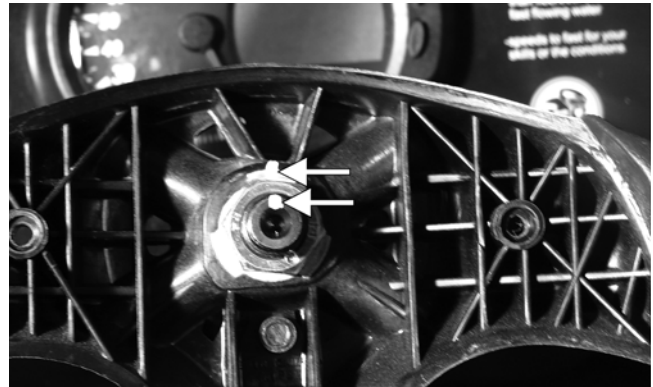

PR324A

- Hold rearward pressure on the steering wheel and tighten the cap screw (from step 2) to specifications.
- Remove the steering wheel nut. Apply one drop of red Loctite #271 to the threads and install the nut. Tighten to specifications.
- Check for freedom of movement of the steering system; then install the steering wheel cover.
- Move the dash panel into position and secure to the frame and center support with the existing hardware.

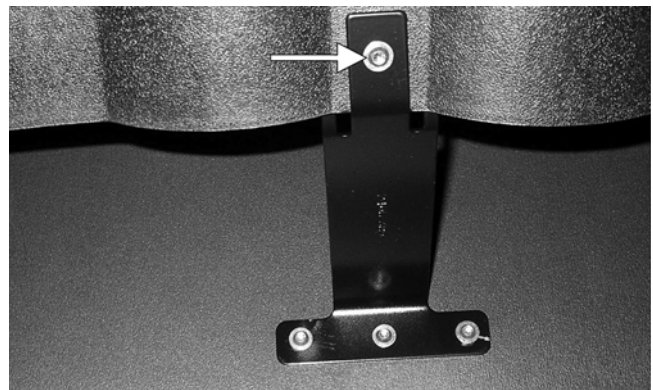

PR475A

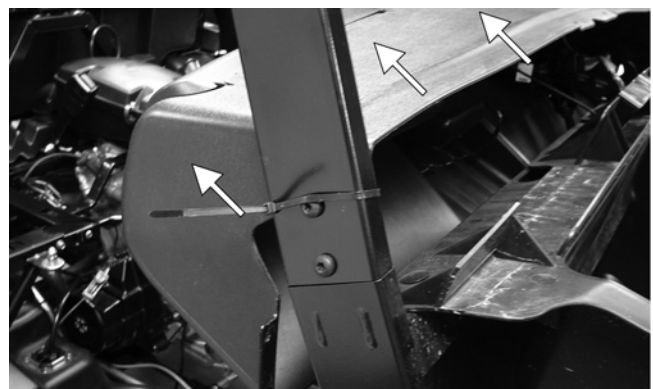

PR181A



## Steering Shaft Assembly

### REMOVING

1. Remove the steering wheel (see Steering Wheel in this section).
2. Remove the six torx-head screws securing the dash panel to the frame and one cap screw and nut from the center support.

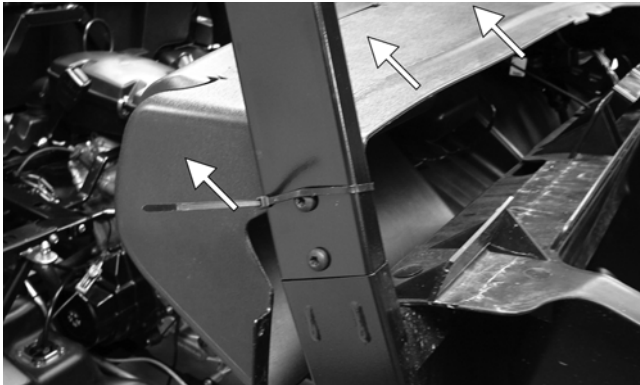

PR181A

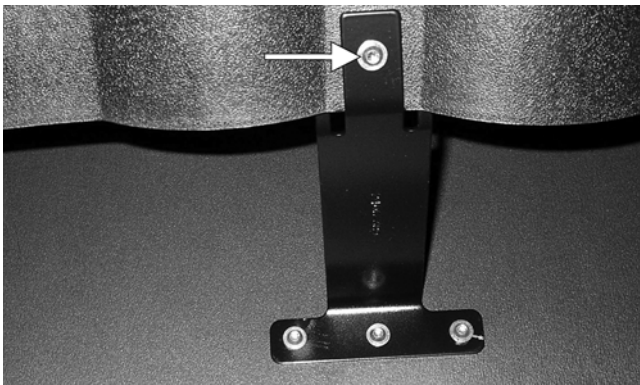

PR475A

3. Slide the dash panel rearward to access the steering shaft joints; then match mark all connecting components for reassembling.

■ **NOTE:** Any time steering components are disassembled, all connecting components should be marked for proper alignment during reassembling.

4. Remove the cap screw securing the upper steering shaft joint to the steering wheel shaft; then slide the steering wheel shaft free of the upper steering shaft joint. Account for one flat thrust washer.

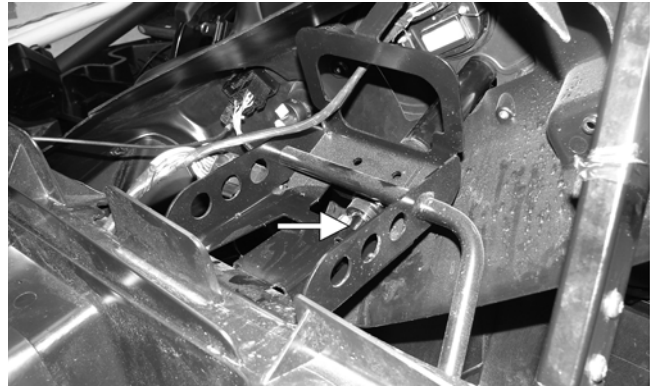

PR313A

5. Remove the cap screw securing the lower steering shaft joint to the pinion shaft; then slide the steering shaft assembly free and remove through the opening in the splash panel.

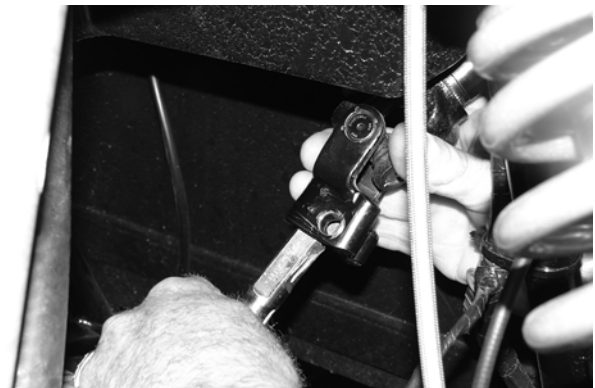

PR304



PR314B

### INSPECTING

■ **NOTE:** The steering shaft assembly is not repairable or rebuildable. If any damage or excessive wear is detected, the assembly must be replaced.

1. Inspect the joints for excessive wear or looseness.
2. Inspect welds and slip-joints for cracks.
3. Check for excessive wobble in the slip-joint.

## INSTALLING

1. Place the steering shaft assembly into position through the opening in the splash panel.

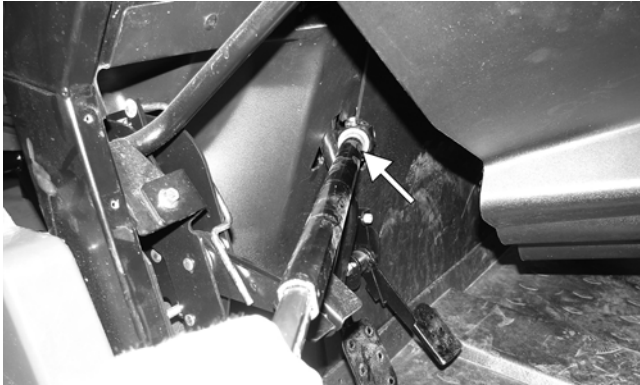

PR314A

2. Align the match marks on the pinion shaft and the lower steering shaft joint; then slide the steering shaft joint onto the pinion shaft.

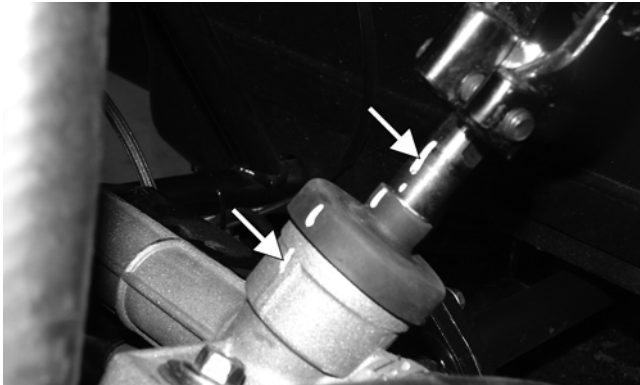

PR333A

3. Apply green Loctite #270 to the cap screw; then secure the lower steering shaft joint to the pinion shaft making sure the pinion shaft does not protrude into the joint beyond the clamping surface. Tighten to specifications.

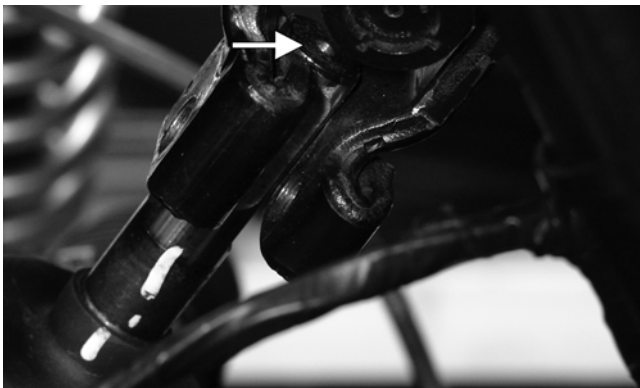

PR309A

## WARNING

Allowing the lower steering shaft joint to extend too far onto the pinion shaft could cause binding or lock-up of the steering joint resulting in loss of steering control.

4. Align the match mark on the upper steering shaft joint with the mark on the steering wheel shaft; then install the flat thrust washer and the steering shaft joint onto the steering wheel shaft.

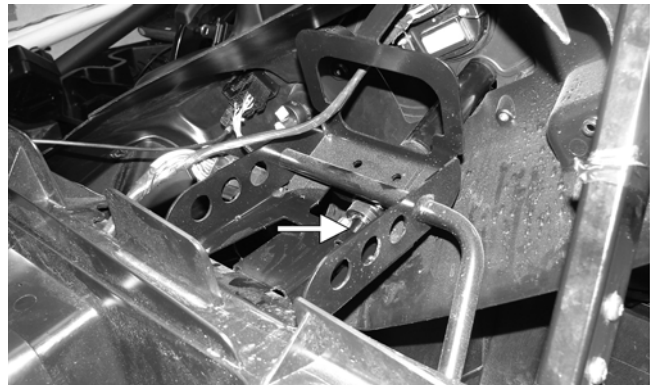

PR313A

5. Apply green Loctite #270 to the cap screw; then install the cap screw in the upper steering shaft joint and finger-tighten.



PR310

6. Install the flat thrust-washer and two wave washers on the steering wheel shaft; then align the match marks on the steering wheel shaft and the steering wheel. Loosely install the nut.





PR226

7. Hold rearward pressure on the steering wheel and tighten the cap screw (from step 5) to specifications.
  8. Remove the steering wheel nut and apply one drop of red Loctite #271 to the threads. Install the nut and tighten to specifications.
  9. Check that the steering wheel turns freely from full-right to full-left; then install the steering wheel cover.
- **NOTE:** If the steering is stiff or the steering wheel is difficult to turn, loosen and then tighten the cap screw on the upper steering shaft joint. Check the steering wheel nut for specified torque value.
10. Place the dash panel into position and secure to the frame and center support with the six torx-head screws and the cap screw and nut.

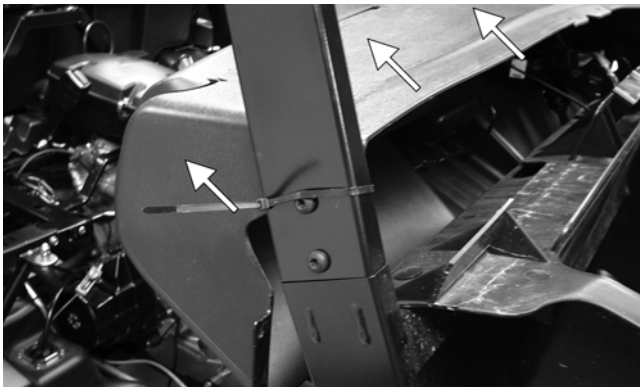

PR181A

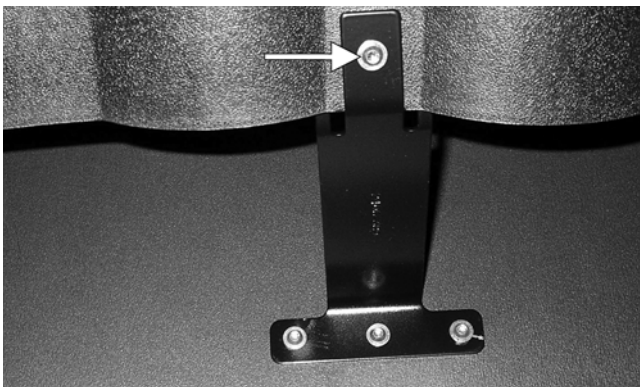

PR475A

## Steering Knuckles

### REMOVING AND DISASSEMBLING

1. Secure the vehicle on a support stand to elevate the wheel; then remove the wheel.

#### **WARNING**

**Make sure the vehicle is solidly supported on the support stand to avoid injury.**

2. Remove the cotter pin from the axle.
3. Remove the nut securing the hub.
4. Remove the brake caliper.
5. Remove the hub assembly.
6. Remove the cotter pin from the tie rod end and remove the tie rod end from the knuckle.
7. Remove the two cap screws securing the ball joints in the knuckle.

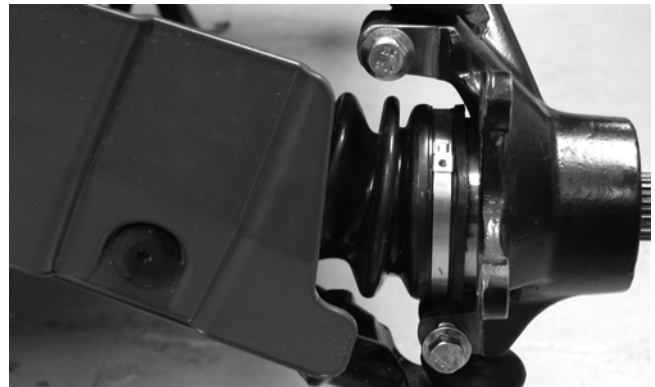

PR193

8. Tap the ball joint end out of the knuckle; then remove the knuckle.
9. Remove the snap ring securing the bearing in the knuckle; then press the bearing out of the knuckle.





PR289

## CLEANING AND INSPECTING

■ **NOTE:** Whenever a part is worn excessively, cracked, or damaged in any way, replacement is necessary.

1. Clean all knuckle components.
2. Inspect the bearing for pits, scoring, rusting, or premature wear.
3. Inspect the knuckle for cracks, breaks, or galling of the bearing surface.

## ASSEMBLING AND INSTALLING

1. Using a suitable press and driver, press the bearing into the knuckle until firmly seated; then install the snap ring.

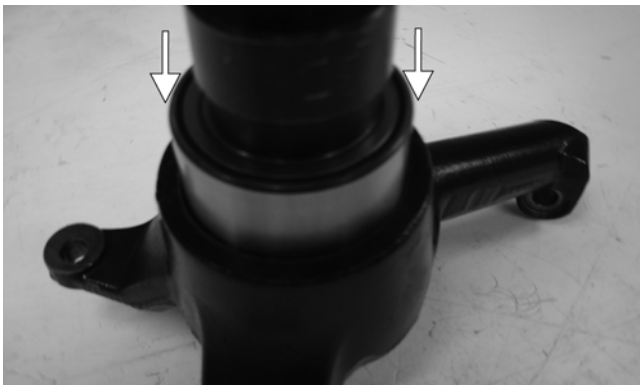

PR292A



PR289

2. Install the knuckle to the upper and lower ball joints and secure with the two cap screws. Tighten to specifications.



PR202



PR203

3. Install the tie rod end and secure with the nut. Tighten to specifications; then install a new cotter pin and spread the pin.

■ **NOTE:** During assembling, new cotter pins should be installed.

4. Apply a small amount of grease to the hub splines.

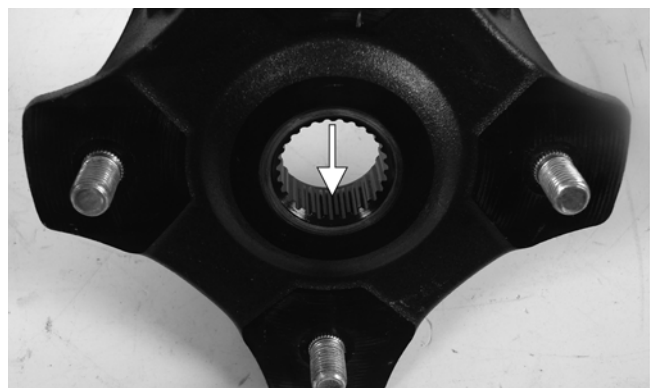

PR290A

5. Install the hub assembly onto the splines of the shaft.

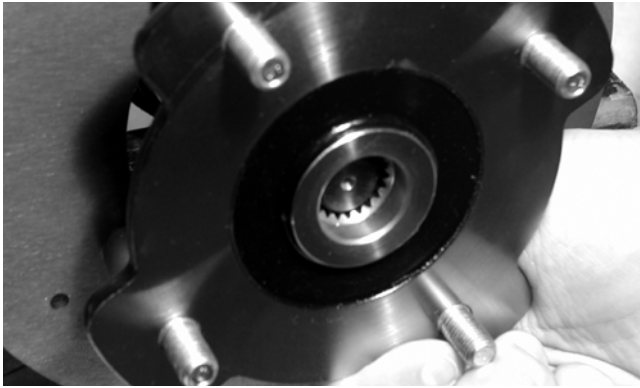

CD009

6. Secure the hub assembly with the nut. Tighten to specifications.

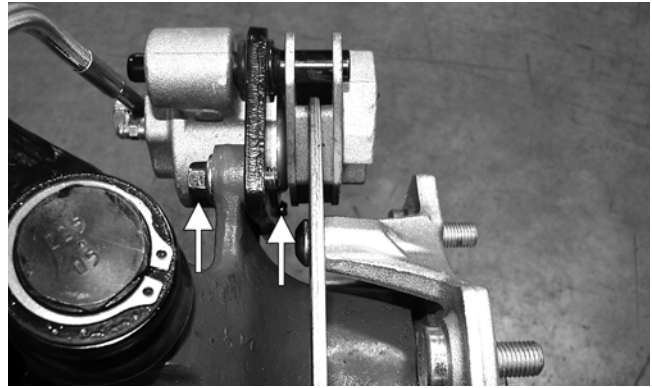

PR377B

9. Install the wheel; then using a crisscross pattern, tighten to specifications.

10. Remove the vehicle from the support stand.

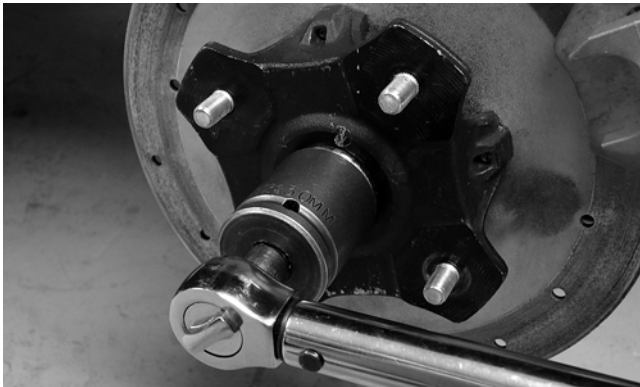

PR256

7. Install a new cotter pin and secure by spreading as shown.



PR260

■ **NOTE:** If the hole in the axle shaft does not align with the slots in the castle nut, tighten the nut until the hole and slots align.

8. Secure the brake caliper to the knuckle with the two cap screws. Tighten to specifications.

---

---

## Checking/Adjusting Front Wheel Alignment

---

---

■ **NOTE:** All measurements and adjustments must be made with the vehicle unloaded.

Mark the center-line of the front tires at the front and rear of the tire; then using a tape measure, measure and record the distance between the marks at the front and rear. The front measurement should be 6-12 mm (1/4-1/2 in.) greater than the rear measurement (toe-out).



PR087A

To adjust the wheel alignment, use the following procedure.

1. Center the steering wheel; then using an open-end wrench to hold the tie rod ends, loosen the right-side and left-side jam nuts.



PR084A

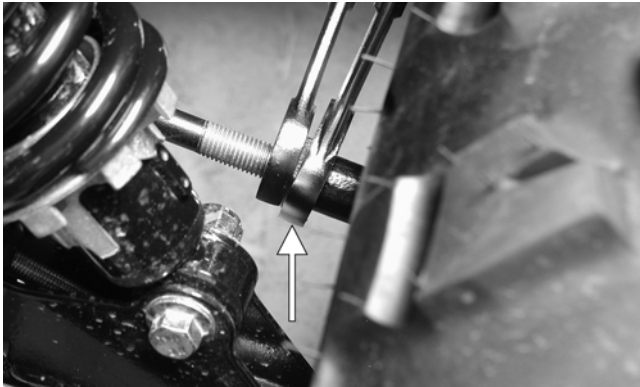

PR085A

**⚠ CAUTION**

Always use a wrench to hold the tie rod ends when loosening or tightening the jam nuts or damage to the boots could occur.

2. Turn the left-side and right-side tie rods in equal increments to achieve the proper toe-out; then tighten the jam nuts securely.



PR086

---

---

## Front Bumper Assembly (XT)

---

### REMOVING

To remove the front bumper assembly, remove four cap screws and nuts. Account for four lock washers and eight flat washers.

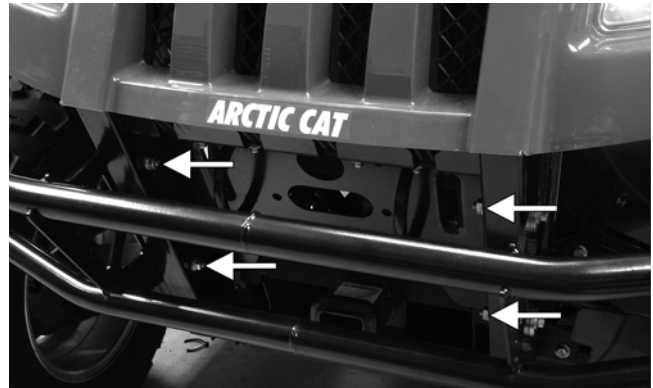

PR327A

### CLEANING AND INSPECTING

■ **NOTE:** Whenever a part is worn excessively, cracked, or damaged in any way, replacement is necessary.

1. Clean all bumper components with parts-cleaning solvent.
2. Inspect all welds for cracking or bending.

### INSTALLING

To install the front bumper assembly, place the bumper assembly into position on the frame; then secure with the four cap screws and nuts making sure the flat washers and lock washers are properly positioned. Tighten securely.

**8**

---

---

## Hood

---

### REMOVING

1. Open the hood; then disconnect the four headlight connectors and remove two nylon ties.



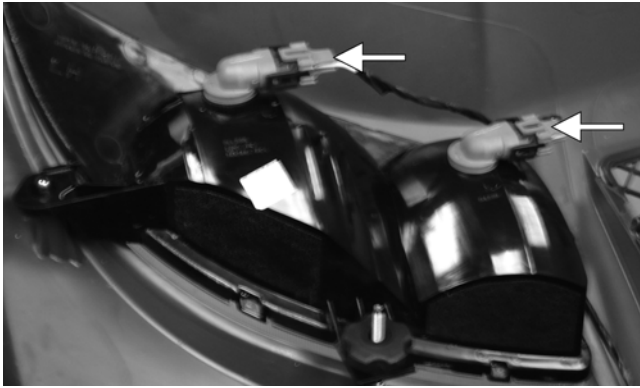

PR328A

2. Loosen but do not remove the four cap screws and flange nuts securing the hood hinge to the frame; then lower the hood.



PR332

3. Connect the four headlight connectors; then secure the wires with two new nylon ties.

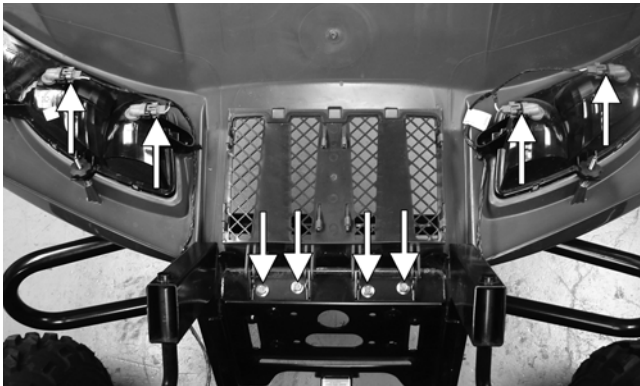

PR332A

3. Finish removing the cap screws and flange nuts (from step 2); then remove the hood assembly.



PR332B

## CLEANING AND INSPECTING

■ **NOTE:** Whenever a part is worn excessively, cracked, or damaged in any way, replacement is necessary.

1. Clean all hood components with parts-cleaning solvent and soap and water.
2. Inspect the hood for cracks and/or loose fasteners.
3. Inspect for any missing decals.

## INSTALLING

1. Place the hood into position on the vehicle; then install the two outside cap screws and flange nuts. Finger-tighten only at this time.
2. Open the hood; then install the remaining two cap screws and flange nuts. Tighten all four securely.

---

---

## Fenders

---

### REMOVING

To remove the fenders, remove three torx-head screws securing each fender to the frame. Account for a stiffener bracket on the front fenders.

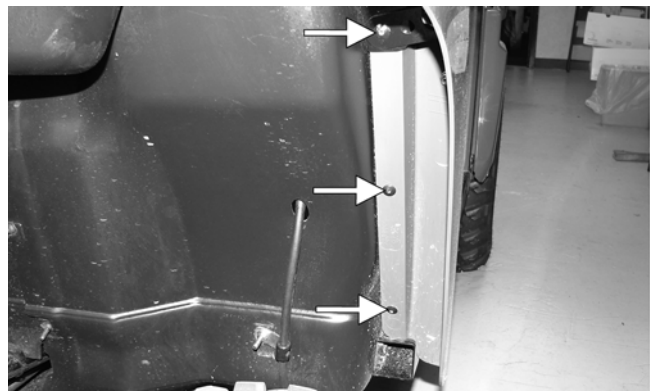

PR311A

### INSTALLING

To install the fenders, place the appropriate fender into position and secure with existing hardware.

---

---

## Floor

---

### REMOVING

1. Remove the seats and center console.
2. Remove twelve cap screws and two self-tapping screws securing the floor to the frame.
3. While pulling forward on the upper-rear of the floor, lift the rear part of the floor above the seat lock stud.

■ **NOTE:** To aid in removing, insert a small wood block to hold in position.



PR163

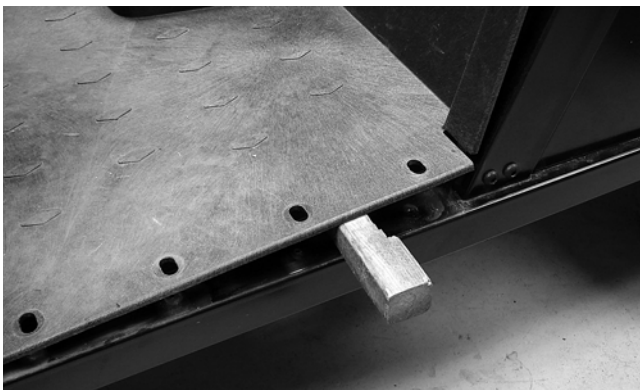

PR164

4. From the opposite side of the vehicle repeat step 3; then lift the rear of the floor up and lift the floor out of the vehicle.

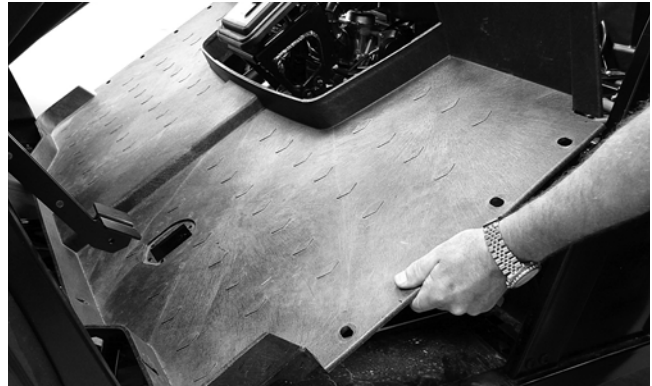

PR165

### CLEANING AND INSPECTING

■ **NOTE:** Whenever a part is worn excessively, cracked, or damaged in any way, replacement is necessary.

1. Clean the floor with soap and water.
2. Inspect the floor for cracks or holes.

### INSTALLING

1. Place the front of the floor into position in the vehicle first; then lower the rear and push past the seat lock studs.
2. Secure the floor with twelve cap screws and two self-tappings screws.
3. Install the center console and seats making sure the seats lock securely into position.

---

---

## Belly Panel

---

### REMOVING

1. Remove the body screws securing the belly panel to the underside of the frame.
2. Remove the belly panel.

### INSTALLING

1. Place the belly panel into position on the underside of the frame.
2. Install the body screws. Tighten securely.

---

---

## Exhaust System

---

### REMOVING MUFFLER

1. Remove the two exhaust springs at the muffler/exhaust pipe juncture.

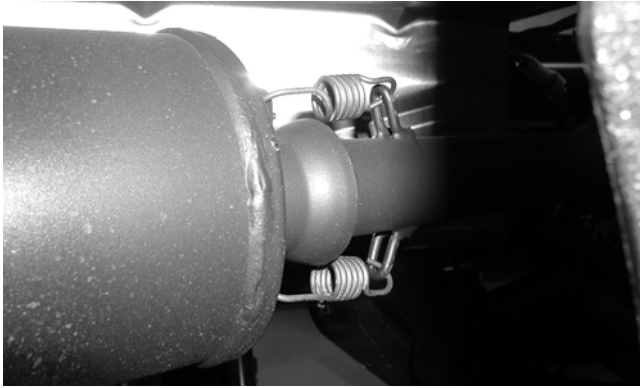

PR131

2. Slide the muffler assembly rearward and clear of the holder pins.

### INSPECTING MUFFLER

■ **NOTE:** Whenever a part is worn excessively, cracked, or damaged in any way, replacement is necessary.

1. Inspect muffler externally for cracks, holes, and dents.
2. Inspect the muffler internally by shaking the muffler back and forth and listening for rattles or loose debris inside the muffler.

■ **NOTE:** For additional details on cleaning the muffler/spark arrester, see Section 2.

### INSTALLING MUFFLER

1. Place the muffler onto the holder pins and slide forward into position.
2. Secure the muffler to the exhaust pipe with the two exhaust springs.

---

---

## Cargo Box

---

### REMOVING

1. Raise the cargo box; then remove the cap screw and nut securing the lower lift support to the frame. The cargo box will tilt fully rearward.



PR102

2. Loosen but do not remove the four shoulder cap screws securing the pivot housings to the cargo box.



PR335

3. Lower the cargo box; then remove the four cap screws (from step 2).
4. With the help of an assistant or an adequate lift, remove the cargo box from the vehicle. Account for four pivot housings.

### CLEANING AND INSPECTING

■ **NOTE:** Whenever a part is worn excessively, cracked, or damaged in any way, replacement is necessary.

1. Clean all cargo box components with soap and water.
2. Inspect the cargo box for cracks, tears, and loose hardware.
3. Inspect the welds of the cargo box frame for cracking or bending.
4. Inspect the cargo box gate latches for smooth operation.



## INSTALLING

1. With the help of an assistant or an adequate lift, set the cargo box into position on the frame; then position the two upper pivot housings between the cargo box and frame. Lightly grease the pivot housings.
2. Align the holes in the upper pivot housings with the holes in the cargo box; then install the lower pivot housings and secure with the four shoulder cap screws. Tighten to specifications.
3. Raise the cargo box; then connect the lift support to the frame, install the cap screw and nut, and tighten the nut securely.
4. Lower the cargo box and lock into position.

---



---

## Adjusting Headlights

---

The headlights can be adjusted vertically. The geometric center of the HIGH beam light zone is to be used for vertical aiming.

1. Position the vehicle on a level floor so the headlights are approximately 6.1 m (20 ft) from an aiming surface (wall or similar aiming surface).

■ **NOTE:** There should be an average operating load on the vehicle when adjusting the headlight aim.

2. Measure the distance from the floor to the mid-point of each headlight.
3. Using the measurements obtained in step 2, make horizontal marks on the aiming surface.
4. Make vertical marks which intersect the horizontal marks on the aiming surface directly in front of the headlights.
5. Switch on the lights. Make sure the HIGH beam is on. **DO NOT USE LOW BEAM.**
6. Observe each headlight beam aim. Proper aim is when the most intense beam is centered on the vertical mark 5 cm (2 in.) below the horizontal mark on the aiming surface.

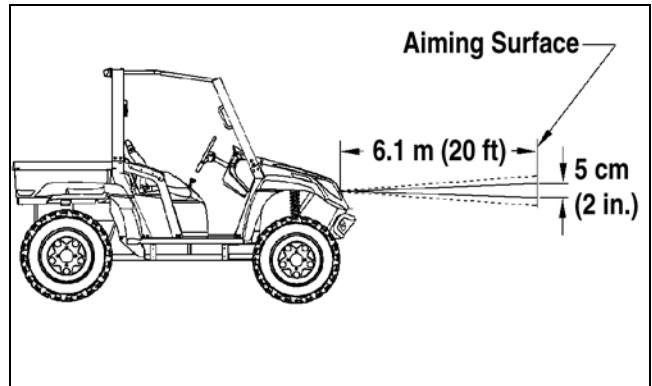

0740-647

7. Turn the adjustment knob counterclockwise to lower the beam and clockwise to raise the beam.

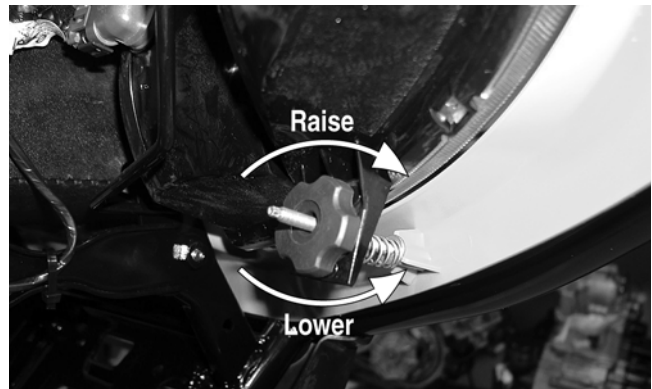

CD714A

### **⚠ WARNING**

Do not operate the vehicle unless the headlight beam is adjusted properly. An incorrectly adjusted beam will not provide the operator the optimum amount of light.

---

## Taillight Assembly

---

### REMOVING

1. Remove two torx-head screws securing the taillight assembly to the rear canopy tube; then rotate the taillight assembly left or right to allow the connector to clear the access opening.



PR056

2. Disconnect the three-prong connector from the bulb socket and remove the taillight assembly.

### INSPECTING

■ **NOTE:** Whenever a part is worn excessively, cracked, or damaged in any way, replacement is necessary.

1. Inspect wiring harness, three-prong connector, lens, base, cap screws, and socket for damage.
2. Inspect all wires for corroding, pinching, and cracking.
3. Inspect the bulb for wattage, voltage, and proper operation.

### INSTALLING

1. Connect the three-prong connector to the bulb socket; then place the taillight assembly into position on the rear canopy tube.
2. Install the two torx-head screws and tighten securely.

---

---

## Seats

---

### REMOVING/INSTALLING

1. To remove a seat, pull the seat lock lever up. Raise the front of the seat and slide it forward.
2. To install a seat, slide the rear of the seat into the seat retainers and push down firmly on the front of seat. The seat should automatically lock into position.

# SECTION 9 - CONTROLS/INDICATORS

---

## TABLE OF CONTENTS

---

Master Cylinder Assembly.....	9-2
Accelerator Pedal .....	9-3
2WD/4WD Selector .....	9-3
Front Differential Lock (XT) .....	9-3
Low Range/High Range/Neutral/Reverse Lever.....	9-4
Speedometer/Tachometer/LCD/ Indicator Light (XT) .....	9-4
Indicator Lights (Prowler) .....	9-6



## Master Cylinder Assembly

■ **NOTE:** The master cylinder is a non-serviceable component; it must be replaced as an assembly.

### REMOVING

1. Slide a piece of flexible tubing over one of the wheel bleeder valves and direct the other end into a container. Remove the reservoir cover; then open the bleeder valve. Allow the brake fluid to drain until the reservoir is empty.



AF637D

2. Remove the cotter pin and pivot pin from the yoke; then remove two cap screws and flange nuts securing the master cylinder assembly to the frame.



PR338



PR336

3. Remove the oil bolt securing the banjo-fittings to the master cylinder; then remove the master cylinder. Discard the three crush washers.

### CAUTION

Brake fluid is highly corrosive. Do not spill brake fluid on any surface of the vehicle.

### INSPECTING

1. Inspect the master cylinder push rod and clevis for wear, bending, or elongation of clevis holes.
2. Inspect the push rod boot for tears or deterioration.
3. Inspect the reservoir for cracks and leakage.
4. Inspect the brake hose for cracks and deterioration and the condition of the banjo-fittings.

### INSTALLING

1. Place the master cylinder into position; then using three new crush washers, secure the two banjo fittings to the master cylinder. Tighten to specifications (see Section 10).
2. Secure the master cylinder assembly to the frame with two cap screws and two flange nuts. Tighten to specifications (see Section 10).
3. Install the pivot pin and secure with a new cotter pin.
4. Fill the master cylinder and bleed the brake system (see Section 2).

## Accelerator Pedal

### REMOVING

To remove the accelerator pedal, dislodge the throttle cable holding grommet from the actuator arm; then remove two torx-head screws and nuts securing the accelerator pedal assembly to the splash panel and remove the accelerator pedal.

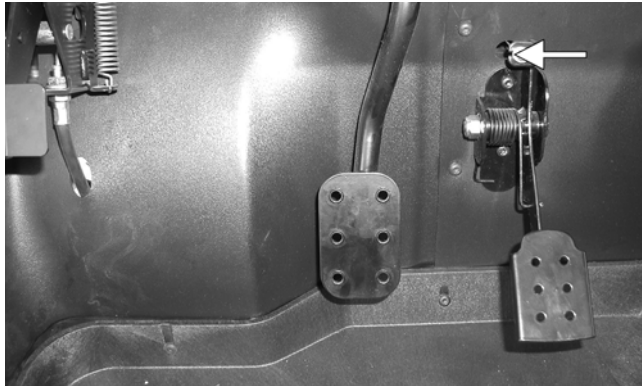

PR342B

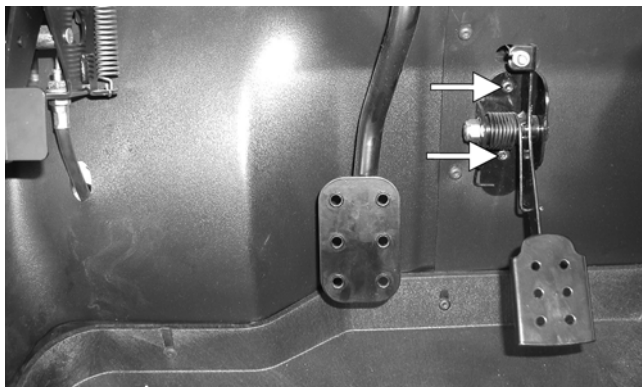

PR342C

### INSTALLING

To install the accelerator pedal, align the mounting holes with the holes in the splash panel and secure with the two torx-head screws and nuts; then snap the throttle cable holding grommet into the actuator arm.

## 2WD/4WD Selector

The automatic drive selector allows the operator to operate in either 2-wheel drive (rear wheels) or 4-wheel drive (all wheels). For normal riding on flat, dry, hard surfaces, 2-wheel drive should be sufficient. In situations of aggressive trail conditions, 4-wheel drive would be the desired choice.

To either engage or disengage the front wheels, move the switch to the 4WD position or to the 2WD position.

### ⚠ CAUTION

Do not attempt to engage or disengage the front differential while the vehicle is moving.

## Front Differential Lock (XT)

The front differential lock allows the operator to mechanically lock the differential to apply equal power to both front wheels. To engage the front differential lock, pull the DIFF LOCK toggle out; to disengage the front differential lock, push the DIFF LOCK toggle in.



PR083

### ADJUSTING CABLE

1. With the toggle in the pushed-in position, slide the rubber protector sleeve (A) off the cable near the toggle; then loosen the jam nut (B) and turn the cable adjuster (C) to achieve 3-4 mm (0.12-0.16 in.) free-travel measured at the toggle.

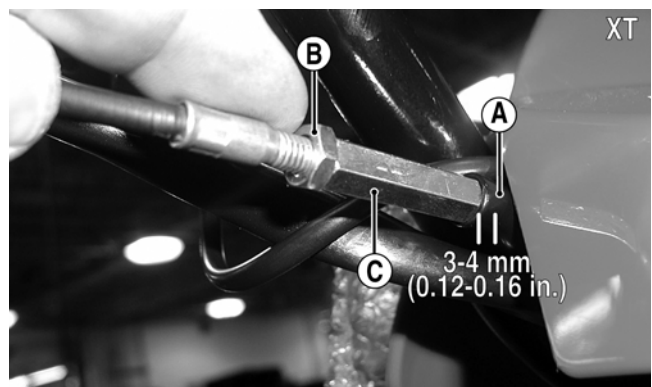

CD560C

2. Select the 2WD position on the 2WD/4WD selector switch; then turn the ignition switch to the ON position and select the LOCK position on the toggle. The front drive actuator should operate engaging four-wheel drive.

■ **NOTE:** It may be necessary to turn the steering wheel or to rock the vehicle forward and backward to align the differential lock splines and allow engagement.

3. Return the toggle to the pushed-in position and listen for the front drive actuator to operate.
4. Turn the ignition switch to the OFF position. Tighten the jam nut securely; then install the protector sleeve on the adjuster assembly.

---

## Low Range/ High Range/Neutral/ Reverse Lever

---

### REMOVING

1. Remove the seats and center console.
2. Remove the flange nut and shoulder screw from the shift lever pivot; then remove the shift lever. Account for the shifter spring.

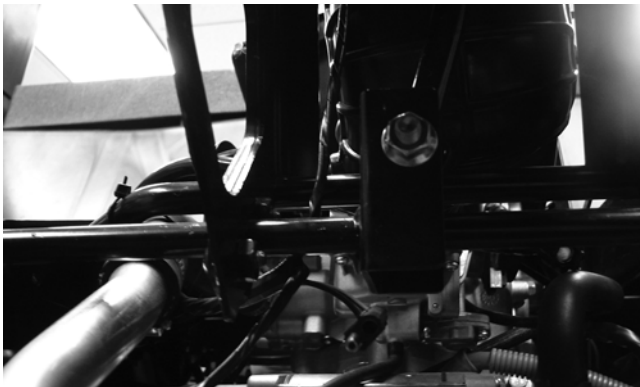

PR340

### INSTALLING

1. With the shifter spring in place on the shift lever, install the shift lever onto the shifter axle.
2. Install the shoulder screw and secure with the flange nut. Tighten to specifications (see Section 10).

---

## Speedometer/ Tachometer/LCD/ Indicator Light (XT)

---

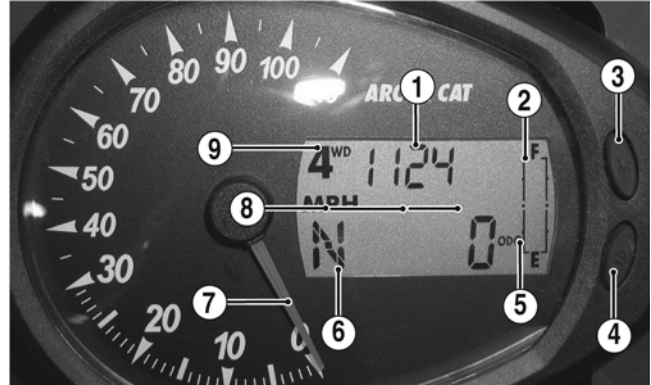

CF094B

1. Clock/Engine Hour Meter - The clock function indicates time in the 12 hour mode; the hour meter indicates the total time the vehicle has run and cannot be reset to zero. To set the clock, use the following procedure.

A. With the ignition switch in the ON position, press and release the Mode Button (3) until the Clock/Engine Hour Meter (1) is displayed; then (if necessary) press and release the Set/Reset Button (4) to the clock display.

B. Press and hold the Set/Reset Button (4) until the minutes stop scrolling and the hour display starts to scroll. Momentarily release when the correct hour is displayed; then repeatedly press and release the Set/Reset Button (4) until the correct minutes are displayed.

■ **NOTE:** Approximately two seconds after releasing either Button, the LCD will return to normal operation.

■ **NOTE:** Clock memory power is supplied through the 15-amp accessory fuse and verified during gauge “power-up” and reset. In the event of clock memory power failure (blown fuse, etc.), the gauge will “power-up,” reset, and shut down repeatedly until clock memory power is restored. Always check the 15-amp accessory fuse if this gauge condition is noted.

■ **NOTE:** The engine hour meter will not activate until engine speed exceeds 500 RPM.

2. Fuel Level Indicator - Indicates approximate amount of gasoline in the gas tank.



■ **NOTE:** When the bottom segment flashes, approximately 3.8 L (1.0 U.S. gal.) of gasoline remains in the tank.

3. Mode Button - Shifts the digital gauge through three modes: speed/tachometer, distance, and time.

■ **NOTE:** The Mode Button must be pressed and released to shift modes. Approximately two seconds after the Mode Button is released, the digital gauge will return to full display.

4. Set/Reset Button - In conjunction with the Mode Button, sets and resets various displays on the digital gauge. Also used to switch from speedometer function to tachometer function on the speedometer/tachometer gauge.

5. Odometer/Trip Meter (#1 and #2) - Odometer registers the total distance the vehicle has traveled. Trip meters can register two distances (for instance, #1 could register trip distance and #2 could register distance between stops). The trip meters can be reset while the odometer only registers accumulated miles/kilometers.

■ **NOTE:** To select the odometer (ODO), trip #1 (T1), or trip #2 (T2), press the Mode Button (3) to select the distance mode; then press the Set/Reset Button (4) to select the desired display. Hold the Set/Reset button down to reset trip meters.

6. Gear Position Indicator - Indicates which gear-shift position is selected.

7. Speed/Tach Indicator - Indicates approximate vehicle speed in mph or k/ph when speedometer function is selected or rpm when tachometer function is selected.

8. Speed Function Display - Displays which speed function (MPH, TACH, K/PH) is being indicated by the Speed/Tach indicator.

■ **NOTE:** The speed and tach functions may be switched by pressing the Set/Reset Button.

9. Differential Lock Indicator - Displays LOCK when the differential lock has been engaged.

10. Drive Select Indicator - Displays 4WD when selected by the 2WD/4WD selector switch or when the differential lock is engaged.

11. High Beam Indicator - The High Beam icon will appear only when the lights are on high beam.

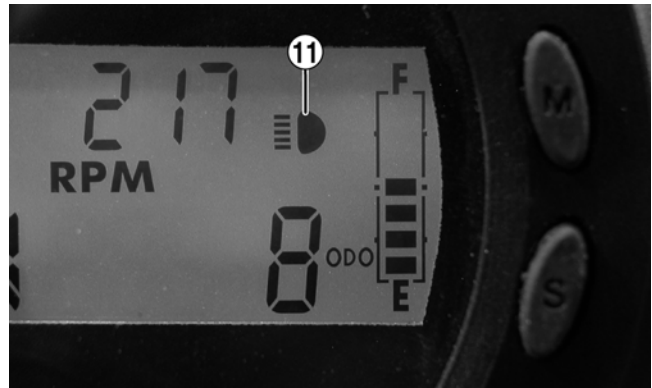

CF101A

12. Battery Condition Indicator - The word VOLT will flash on the LCD whenever a low voltage (< 9 DC volts) or high voltage (>16 DC volts) is detected.



CF098A

13. Temperature Indicator - The high temperature icon will flash and the speed/tach needle will sweep full scale if the engine overheats. After 30 seconds, the speed/tach needle will return to normal, but the temperature icon will continue to flash. The icon should not be visible during normal operation.



CF099A

**CAUTION**  
Continued operation of the vehicle with high engine temperature may result in engine damage or premature wear.

14. Parking Brake Indicator - A red light will illuminate when the parking brake is applied and the ignition switch is in the ON position. The light will go off when the parking brake is released.



### REPLACING SPEEDOMETER/ TACHOMETER/LCD

To replace the speedometer, use the following procedure.

1. Remove the six torx-head screws securing the dash panel to the frame; then remove the parking brake handle and jam nut.
2. Slide the dash panel to the rear sufficiently to access the components.

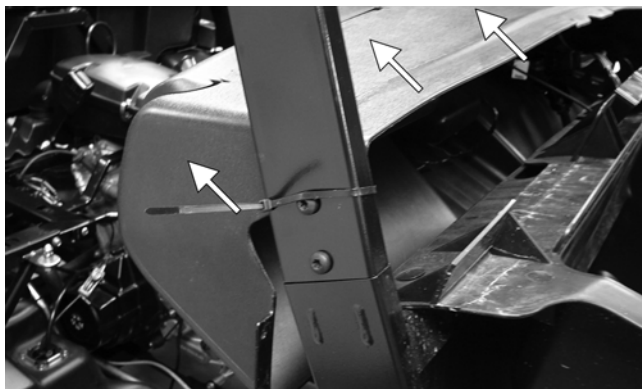

3. Remove two nuts securing the gauge assembly to the dash; then unplug the multi-pin connector and remove the gauge from the vehicle.

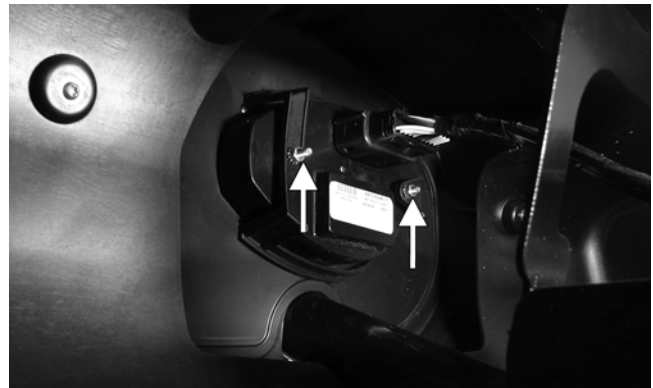

4. Place the new gauge into the dash panel opening; then place the gauge holder over the mounting screws and secure with the two nuts.
5. Plug the multi-pin connector into the gauge; then turn the ignition switch to the ON position and check gauge functions.
6. Slide the dash into position and secure with the six torx-head screws.
7. Install the parking brake handle and jam nut.

### Indicator Lights (Prowler)

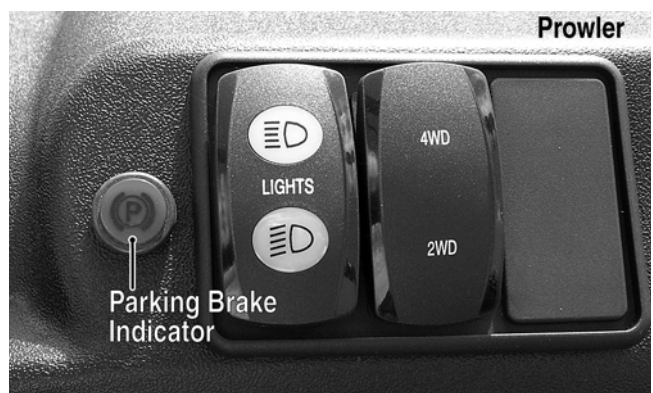
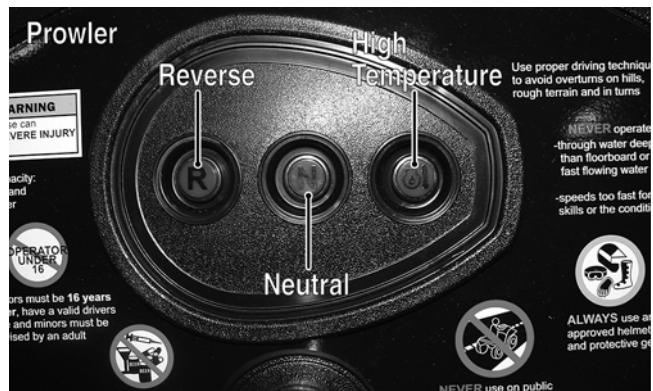

1. Temperature Indicator - A red light will illuminate if the engine overheats. The light should be off during normal operation.

 **CAUTION**

Continued operation of the vehicle with high engine temperature may result in engine damage or premature wear.

■ **NOTE:** High engine RPM, low vehicle speed, or heavy load can raise engine temperature. Decreasing engine RPM, reducing load, and selecting an appropriate transmission gear can lower the temperature.

■ **NOTE:** Debris in front of the engine or packed between the cooling fins of the radiator or the oil cooler cooling fins can reduce cooling capability. Using a hose, pressure-wash the radiator and oil cooler.

2. Neutral Indicator - A green light will illuminate when the transmission is in neutral and the ignition switch is on. The light will go out when shifted into any gear other than neutral.
3. Reverse Indicator - A red light will illuminate when the transmission is shifted into reverse gear. The light will go off when shifted out of reverse.
4. Parking Brake Indicator - A red light will illuminate when the parking brake is applied and the ignition switch is on. The light will go off when the parking brake is released.



# SECTION 10 - AIDS FOR MAINTENANCE

---

---

## TABLE OF CONTENTS

---

Torque Specifications .....	10-2
Torque Conversions .....	10-4
Tightening Torque (General Bolts) .....	10-4

# Torque Specifications

DRIVE TRAIN COMPONENTS			
Part	Part Bolted To	Torque	
		kg-m	ft-lb
Engine Cradle	Engine	5.5	40.0
Engine Cradle	Rubber Mount	3.5	25.0
Front Differential*	Frame/Differential Bracket	6.2	45.0
Rear Output Flange	Rear U-Joint Flange	5.5	40.0
Input Housing	Differential Housing	2.9-3.5	21.0-25.0
Diff Housing Cover***	Differential Housing	2.9-3.5	21.0-25.0
Drive Bevel Gear Nut***	Shaft	11.0-13.0	79.5-94.0
Differential Gear Case***	Hub	2.3-3.0	16.5-22.0
Lock Collar	Differential Housing	17.3	125.0
Hub Nut	Front/Rear Shaft/Axle (min)	27.6	200.0
Oil Drain Plug	Front Differential/Rear Drive	0.5	3.5
Oil Fill Plug	Front Differential/Rear Drive	2.2	16.0
Oil Drain Plug	Engine	2.2	16.0
Inspection Plug	Rear Drive	0.5	3.5
Wheel	Hub	5.5-6.2	40.0-45.0
Front Shaft Flange	Front U-Joint	2.8	20.0
EXHAUST COMPONENTS			
Exhaust Pipe	Engine	2.8	20.0
ELECTRICAL COMPONENTS			
Coil*	Frame	1.1	8.0
Ground Wire	Engine	1.1	8.0
STEERING COMPONENTS			
Steering Wheel Shaft**	Steering Wheel	3.5	25.0
Steering Wheel Shaft	Intermediate Shaft (Upper)	3.5	25.0
Intermediate Shaft (Lower)	Steering Pinion Shaft	3.5	25.0
Rack and Pinion	Frame	6.9	50.0
Tie Rod End	Knuckle	4.2	30.0
Jam Nut	Tie Rod End	1.1	8.0

BRAKE COMPONENTS			
Part	Part Bolted To	Torque	
		kg-m	ft-lb
Brake Disc*	Hub	2.1	15.0
Brake Hose	Caliper	2.8	20.0
Brake Hose	Master Cylinder	2.8	20.0
Master Cylinder	Frame	3.5	25.0
Parking Brake Mechanism	Frame	2.8	20.0
Hydraulic Caliper	Knuckle	2.8	20.0
Rear Caliper	Rear Drive Gear Case	2.8	20.0
Drive-line Brake	Rear Drive Input Flange	1.7	12.0
CHASSIS COMPONENTS			
Shift Lever*	Shift Axle Bracket	2.8	20.0
SUSPENSION COMPONENTS (Front)			
A-Arm	Frame	4.6	33.0
Ball Joint Cap Screw	Knuckle	4.8	35.0
Shock Absorber (Upper)	Frame	4.6	33.0
Shock Absorber (Lower)	Upper A-Arm	4.6	33.0
Knuckle	A-Arm	4.6	33.0
SUSPENSION COMPONENTS (Rear)			
Axle Retainer Assy	Axle Housing	5.5	40.0
Sway Bar Bracket	Frame	4.6	33.0
A-Arm	Frame	4.6	33.0
Shock Absorber (Upper)	Frame	4.6	33.0
Shock Absorber (Lower)	Lower A-Arm	2.8	20.0
Knuckle	A-Arm	4.6	33.0
Cargo Box Hinge	Cargo Box Frame	2.8	20.0
Cargo Box	Cargo Box Frame	2.8	20.0
Latch Pivot Bushing	Cargo Box Frame	2.1	15.0
Latch Striker	Cargo Box Liner	1.4	10.0
CANOPY ASSEMBLY			
Front/Rear Canopy Tube	Arm Rest/Steering Post Support	2.8	20.0
Top Canopy Support	Front/Rear Canopy Tubes	1.1	8.0
Rear Canopy Tube	Lower Canopy Support	1.1	8.0

ENGINE/TRANSMISSION			
Part	Part Bolted To	Torque	
		kg-m	ft-lb
Clutch Shoe**	Crankshaft	31.8	230.0
Clutch Cover/ Housing Assembly	Crankcase	1.1	8.0
Crankcase Half (6 mm)	Crankcase Half	0.9-1.3	6.5-9.5
Crankcase Half (8 mm)	Crankcase Half	2.8	20.0
Cylinder Head (Cap Screw)	Crankcase	5.5	40.0
Cylinder Head (6 mm)	Cylinder	1.1	8.0
Cylinder Head (8 mm)	Cylinder	2.5	18.0
Cylinder Head Cover	Cylinder Head	1.15	8.5
Driven Pulley Nut	Fixed Face	13.5	97.5
Fixed Driven	Clutch Shaft	13.5	97.5
Ground Wire	Engine	1.1	8.0
Magneto Cover	Crankcase	1.1	8.0
Mechanical Water Pump Impeller	Pump Shaft	1.05	7.5
Movable Drive Face	Driveshaft	10.4-11.8	75.0-85.0
Oil Pump Drive Gear	Crank Balancer Shaft	8.5	61.5
Output Shaft Gear	Output Shaft	8.5	61.5
Outer Magneto Cover	Right-Side Cover	0.8	6.0
Rotor/Flywheel Nut	Crankshaft	14.5	105.0
Cam Sprocket**	Camshaft	1.35	9.8
Starter Cup	Crankshaft	3.8	27.5
V-Belt Cover	Crankcase	1.1	8.0
Plenum***	Engine	1.1	8.0
Spark Plug	Engine	1.7	12.0

\* w/Blue Loctite #243

\*\* w/Red Loctite #271

\*\*\* w/Green Loctite #609





## Torque Conversions

ft-lb	kg-m	ft-lb	kg-m	ft-lb	kg-m	ft-lb	kg-m	ft-lb	kg-m
1	0.1	21	2.9	41	5.7	61	8.4	81	11.2
2	0.3	22	3.0	42	5.8	62	8.6	82	11.3
3	0.4	23	3.2	43	5.8	63	8.7	83	11.5
4	0.6	24	3.3	44	6.1	64	8.9	84	11.6
5	0.7	25	3.5	45	6.2	65	9.0	85	11.8
6	0.8	26	3.6	46	6.4	66	9.1	86	11.9
7	1.0	27	3.7	47	6.5	67	9.3	87	12.0
8	1.1	28	3.9	48	6.6	68	9.4	88	12.2
9	1.2	29	4.0	49	6.8	69	9.5	89	12.3
10	1.4	30	4.2	50	6.9	70	9.7	90	12.5
11	1.5	31	4.3	51	7.1	71	9.8	91	12.6
12	1.7	32	4.4	52	7.2	72	10.0	92	12.8
13	1.8	33	4.6	53	7.3	73	10.1	93	12.9
14	1.9	34	4.7	54	7.5	74	10.2	94	13.0
15	2.1	35	4.8	55	7.6	75	10.4	95	13.1
16	2.2	36	5.0	56	7.7	76	10.5	96	13.3
17	2.4	37	5.1	57	7.9	77	10.7	97	13.4
18	2.5	38	5.3	58	8.0	78	10.8	98	13.6
19	2.6	39	5.4	59	8.2	79	10.9	99	13.7
20	2.8	40	5.5	60	8.3	80	11.1	100	13.8

## Tightening Torque (General Bolts)

Type of Bolt	Thread Diameter A (mm)	Tightening Torque	
		kg-m	ft-lb
(Conventional or 4 Marked Bolt)	5	0.2-0.4	1.5-3.0
	6	0.4-0.7	3.0-5.0
	8	1.0-1.6	7.0-11.5
	10	2.2-3.5	16.0-25.5
(7 Marked Bolt)	5	0.3-0.6	2.0-4.5
	6	0.8-1.2	6.0-8.5
	8	1.8-2.8	13.0-20.0
	10	4.0-6.0	29.0-43.5

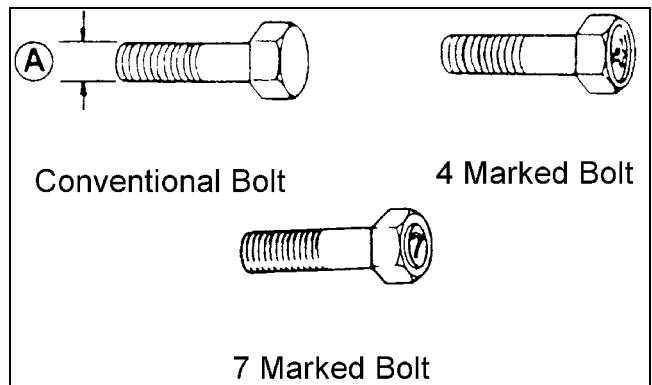

# SECTION 11 - TROUBLESHOOTING

---

---

## TABLE OF CONTENTS

---

Engine .....	11-2
Drive .....	11-5
Fuel System .....	11-6
Electrical.....	11-7
Steering/Suspension .....	11-9
Brakes .....	11-10

## Engine

Problem: Engine will not start or is hard to start (Compression too low)	
Condition	Remedy
1. <b>Valve clearance</b> out of adjustment	1. Adjust clearance
2. <b>Valve guides</b> worn - seated poorly	2. Repair - replace guides
3. <b>Valves</b> mistimed	3. Replace camshaft
4. <b>Piston rings</b> worn - broken	4. Replace rings
5. <b>Cylinder bore</b> worn	5. Replace - rebore cylinder
6. <b>Starter motor</b> cranks too slowly - does not turn	6. See Electrical in this section
Problem: Engine will not start or is hard to start (No spark)	
Condition	Remedy
1. <b>Spark plug</b> fouled	1. Clean - replace plug
2. <b>Spark plug</b> wet	2. Clean - dry plug
3. <b>Magneto</b> defective	3. Replace magneto
4. <b>CDI unit</b> defective	4. Replace CDI unit
5. <b>Ignition coil</b> defective	5. Replace ignition coil
6. <b>High-tension lead</b> open - shorted	6. Replace high tension lead
Problem: Engine will not start or is hard to start (No fuel reaching the carburetor)	
Condition	Remedy
1. <b>Gas tank vent hose</b> obstructed	1. Clean vent hose
2. <b>Carburetor float valve</b> defective	2. Replace valve
3. <b>Fuel hose</b> obstructed	3. Clean - replace hose
4. <b>Fuel screens</b> obstructed	4. Clean - replace inlet screen - valve screen
5. <b>Fuel pump</b> defective	5. Replace fuel pump
Problem: Engine stalls easily	
Condition	Remedy
1. <b>Spark plug</b> fouled	1. Clean - replace plug
2. <b>Magneto</b> defective	2. Replace magneto
3. <b>CDI unit</b> defective	3. Replace CDI unit
4. <b>Carburetor jets</b> obstructed	4. Clean jets
5. <b>Valve clearance</b> out of adjustment	5. Adjust clearance
Problem: Engine noisy (Excessive valve chatter)	
Condition	Remedy
1. <b>Valve clearance</b> excessive	1. Adjust clearance
2. <b>Valve spring(s)</b> weak - broken	2. Replace spring(s)
3. <b>Rocker arm - rocker arm shaft</b> worn	3. Replace arm - shaft
4. <b>Camshaft</b> worn	4. Replace camshaft
Problem: Engine noisy (Noise seems to come from piston)	
Condition	Remedy
1. <b>Piston - cylinder</b> worn	1. Replace - service piston - cylinder
2. <b>Combustion chamber carbon</b> buildup	2. Clean chamber
3. <b>Piston pin - piston pin bore</b> worn	3. Replace - service pin - bore
4. <b>Piston rings - ring groove(s)</b> worn	4. Replace rings - piston



<b>Problem: Engine noisy (Noise seems to come from timing chain)</b>	
<b>Condition</b>	<b>Remedy</b>
<ol style="list-style-type: none"> <li>1. <b>Chain</b> stretched</li> <li>2. <b>Sprockets</b> worn</li> <li>3. <b>Tension adjuster</b> malfunctioning</li> </ol>	<ol style="list-style-type: none"> <li>1. Replace chain</li> <li>2. Replace sprockets</li> <li>3. Repair - replace adjuster</li> </ol>
<b>Problem: Engine noisy (Noise seems to come from crankshaft)</b>	
<b>Condition</b>	<b>Remedy</b>
<ol style="list-style-type: none"> <li>1. <b>Bearing</b> worn - burned</li> <li>2. <b>Lower rod-end bearing</b> worn - burned</li> <li>3. <b>Connecting rod side clearance</b> too large</li> <li>4. <b>Centrifugal clutch</b> loose</li> <li>5. <b>Rotor/flywheel</b> loose</li> </ol>	<ol style="list-style-type: none"> <li>1. Replace bearing</li> <li>2. Replace bearing</li> <li>3. Replace thrust washer(s)</li> <li>4. Tighten - replace clutch</li> <li>5. Tighten - replace flywheel - crankshaft</li> </ol>
<b>Problem: Engine noisy (Noise seems to come from transmission)</b>	
<b>Condition</b>	<b>Remedy</b>
<ol style="list-style-type: none"> <li>1. <b>Gears</b> worn - rubbing</li> <li>2. <b>Splines</b> worn</li> <li>3. <b>Primary gears</b> worn - rubbing</li> <li>4. <b>Bearings</b> worn</li> <li>5. <b>Bushing</b> worn</li> </ol>	<ol style="list-style-type: none"> <li>1. Replace gears</li> <li>2. Replace shaft(s)</li> <li>3. Replace gears</li> <li>4. Replace bearings</li> <li>5. Replace bushing</li> </ol>
<b>Problem: Engine noisy (Noise seems to come from secondary bevel gear and final driven shaft)</b>	
<b>Condition</b>	<b>Remedy</b>
<ol style="list-style-type: none"> <li>1. <b>Drive - driven bevel gears</b> damaged - worn</li> <li>2. <b>Backlash</b> excessive</li> <li>3. <b>Tooth contact</b> improper</li> <li>4. <b>Bearing</b> damaged</li> <li>5. <b>Gears</b> worn - rubbing</li> <li>6. <b>Splines</b> worn</li> <li>7. <b>Final driven shaft thrust clearance</b> too large</li> </ol>	<ol style="list-style-type: none"> <li>1. Replace gears</li> <li>2. Adjust backlash</li> <li>3. Adjust contact</li> <li>4. Replace bearing</li> <li>5. Replace gears</li> <li>6. Replace shaft(s)</li> <li>7. Replace thrust washer(s)</li> </ol>
<b>Problem: Engine idles poorly</b>	
<b>Condition</b>	<b>Remedy</b>
<ol style="list-style-type: none"> <li>1. <b>Valve clearance</b> out of adjustment</li> <li>2. <b>Valve seating</b> poor</li> <li>3. <b>Valve guides</b> defective</li> <li>4. <b>Rocker arms - arm shaft</b> worn</li> <li>5. <b>Magneto</b> defective</li> <li>6. <b>CDI unit</b> defective</li> <li>7. <b>Spark plug</b> fouled - <b>gap</b> too wide</li> <li>8. <b>Ignition coil</b> defective</li> <li>9. <b>Float</b> out of adjustment</li> <li>10. <b>Jets</b> obstructed</li> <li>11. <b>Pilot screw setting</b> improper</li> </ol>	<ol style="list-style-type: none"> <li>1. Adjust clearance</li> <li>2. Replace - service seats - valves</li> <li>3. Replace guides</li> <li>4. Replace arms - shafts</li> <li>5. Replace magneto</li> <li>6. Replace CDI unit</li> <li>7. Adjust gap - replace plug</li> <li>8. Replace ignition coil</li> <li>9. Adjust float height</li> <li>10. Clean jets</li> <li>11. Adjust pilot screw</li> </ol>

<b>Problem: Engine runs poorly at high speed</b>	
<b>Condition</b>	<b>Remedy</b>
<ol style="list-style-type: none"> <li>1. <b>High RPM “cut out”</b> against RPM limiter</li> <li>2. <b>Valve springs</b> weak</li> <li>3. <b>Valve timing</b> out of adjustment</li> <li>4. <b>Cams - rocker arms</b> worn</li> <li>5. <b>Spark plug gap</b> too narrow</li> <li>6. <b>Ignition coil</b> defective</li> <li>7. <b>Float level</b> too low</li> <li>8. <b>Air cleaner element</b> obstructed</li> <li>9. <b>Fuel hose</b> obstructed</li> </ol>	<ol style="list-style-type: none"> <li>1. Shift into higher gear - decrease speed</li> <li>2. Replace springs</li> <li>3. Adjust timing</li> <li>4. Replace cams - arms</li> <li>5. Adjust gap</li> <li>6. Replace ignition coil</li> <li>7. Adjust float height</li> <li>8. Clean element</li> <li>9. Clean - prime hose</li> </ol>
<b>Problem: Exhaust smoke dirty or heavy</b>	
<b>Condition</b>	<b>Remedy</b>
<ol style="list-style-type: none"> <li>1. <b>Oil (in the engine)</b> overfilled - contaminated</li> <li>2. <b>Piston rings - cylinder</b> worn</li> <li>3. <b>Valve guides</b> worn</li> <li>4. <b>Cylinder wall</b> scored - scuffed</li> <li>5. <b>Valve stems</b> worn</li> <li>6. <b>Stem seals</b> defective</li> </ol>	<ol style="list-style-type: none"> <li>1. Drain excess oil - replace oil</li> <li>2. Replace - service rings - cylinder</li> <li>3. Replace guides</li> <li>4. Replace cylinder</li> <li>5. Replace valves</li> <li>6. Replace seals</li> </ol>
<b>Problem: Engine lacks power</b>	
<b>Condition</b>	<b>Remedy</b>
<ol style="list-style-type: none"> <li>1. <b>Valve clearance</b> incorrect</li> <li>2. <b>Valve springs</b> weak</li> <li>3. <b>Valve timing</b> out of adjustment</li> <li>4. <b>Piston ring(s) - cylinder</b> worn</li> <li>5. <b>Valve seating</b> poor</li> <li>6. <b>Spark plug</b> fouled</li> <li>7. <b>Rocker arms - shafts</b> worn</li> <li>8. <b>Spark plug gap</b> incorrect</li> <li>9. <b>Carburetor jets</b> obstructed</li> <li>10. <b>Float level</b> out of adjustment</li> <li>11. <b>Air cleaner element</b> obstructed</li> <li>12. <b>Oil (in the engine)</b> overfilled - contaminated</li> <li>13. <b>Intake manifold</b> leaking air</li> <li>14. <b>Cam chain</b> worn</li> </ol>	<ol style="list-style-type: none"> <li>1. Adjust clearance</li> <li>2. Replace springs</li> <li>3. Time camshaft</li> <li>4. Replace - service rings - cylinder</li> <li>5. Repair seats</li> <li>6. Clean - replace plug</li> <li>7. Replace arms - shafts</li> <li>8. Adjust gap - replace plug</li> <li>9. Clean jets</li> <li>10. Adjust float height</li> <li>11. Clean element</li> <li>12. Drain excess oil - change oil</li> <li>13. Tighten - replace manifold</li> <li>14. Replace cam chain - sprockets</li> </ol>

<b>Problem: Engine overheats</b>	
<b>Condition</b>	<b>Remedy</b>
1. <b>Carbon deposit (piston crown)</b> excessive	1. Clean piston
2. <b>Oil</b> low	2. Add oil
3. <b>Octane</b> low - <b>gasoline</b> poor	3. Drain - replace gasoline
4. <b>Oil pump</b> defective	4. Replace pump
5. <b>Oil circuit</b> obstructed	5. Clean circuit
6. <b>Gasoline level (in float chamber)</b> too low	6. Adjust float height
7. <b>Intake manifold</b> leaking air	7. Tighten - replace manifold
8. <b>Coolant level</b> low	8. Fill - examine system for leaks
9. <b>Fan</b> malfunctioning	9. Check fan fuse - replace fan
10. <b>Fan switch</b> malfunctioning	10. Replace fan switch
11. <b>Thermostat</b> stuck - closed	11. Replace thermostat
12. <b>Radiator hoses - cap</b> damaged - obstructed	12. Clear obstruction - replace hoses

---

## Drive

---

<b>Problem: Power not transmitted from engine to wheels</b>	
<b>Condition</b>	<b>Remedy</b>
1. <b>Rear axle shaft serration</b> worn - broken	1. Replace shaft

<b>Problem: Power not transmitted from engine to either front wheel</b>	
<b>Condition</b>	<b>Remedy</b>
1. <b>Secondary drive - driven gear teeth</b> broken	1. Replace gear(s)
2. <b>Propeller shaft serration</b> worn - broken	2. Replace shaft
3. <b>Coupling</b> damaged	3. Replace coupling
4. <b>Coupling joint serration</b> worn - damaged	4. Replace joint
5. <b>Front drive - driven bevel gears</b> broken - damaged	5. Replace gear(s)
6. <b>Front differential gears/pinions</b> broken - damaged	6. Replace gears - pinions
7. <b>Front drive actuator</b> not operating	7. Replace fuse - 2WD/4WD switch - front drive actuator



## Fuel System

Problem: Starting impaired	
Condition	Remedy
<ol style="list-style-type: none"> <li>1. <b>Starter jet</b> obstructed</li> <li>2. <b>Starter jet passage</b> obstructed</li> <li>3. <b>Carburetor</b> leaking air</li> </ol>	<ol style="list-style-type: none"> <li>1. Clean jet</li> <li>2. Clean passage</li> <li>3. Replace gasket</li> </ol>
Problem: Idling or low speed impaired	
Condition	Remedy
<ol style="list-style-type: none"> <li>1. <b>Slow jet</b> obstructed - loose</li> <li>2. <b>Slow jet outlet</b> obstructed</li> <li>3. <b>Pilot screw setting</b> incorrect</li> <li>4. <b>Float height</b> incorrect</li> </ol>	<ol style="list-style-type: none"> <li>1. Clean - tighten jet</li> <li>2. Clean outlet</li> <li>3. Adjust screw</li> <li>4. Adjust float height</li> </ol>
Problem: Medium or high speed impaired	
Condition	Remedy
<ol style="list-style-type: none"> <li>1. <b>High RPM "cut out"</b> against RPM limiter</li> <li>2. <b>Main jet</b> obstructed</li> <li>3. <b>Needle jet</b> obstructed</li> <li>4. <b>Vacuum piston</b> not operating properly</li> <li>5. <b>Filter</b> obstructed</li> <li>6. <b>Float height</b> incorrect</li> </ol>	<ol style="list-style-type: none"> <li>1. Shift into higher gear - decrease RPM speed</li> <li>2. Clean main jet</li> <li>3. Clean needle jet</li> <li>4. Check piston operation</li> <li>5. Clean filter</li> <li>6. Adjust float height</li> </ol>
Problem: Overflow and fuel level fluctuations	
Condition	Remedy
<ol style="list-style-type: none"> <li>1. <b>Float valve</b> worn - damaged</li> <li>2. <b>Float valve spring</b> broken</li> <li>3. <b>Float</b> not working properly</li> <li>4. <b>Float valve</b> dirty</li> <li>5. <b>Float height</b> too high - too low</li> </ol>	<ol style="list-style-type: none"> <li>1. Replace valve</li> <li>2. Replace spring</li> <li>3. Adjust float height - replace float</li> <li>4. Clean valve</li> <li>5. Adjust float height</li> </ol>

## Electrical

Problem: Spark absent or weak	
Condition	Remedy
<ol style="list-style-type: none"> <li>1. <b>Ignition coil</b> defective</li> <li>2. <b>Spark plug</b> defective</li> <li>3. <b>Magneto</b> defective</li> <li>4. <b>CDI unit</b> defective</li> <li>5. <b>Pick-up coil</b> defective</li> </ol>	<ol style="list-style-type: none"> <li>1. Replace ignition coil</li> <li>2. Replace plug</li> <li>3. Replace magneto</li> <li>4. Replace CDI unit</li> <li>5. Replace pick-up coil</li> </ol>
Problem: Spark plug fouled with carbon	
Condition	Remedy
<ol style="list-style-type: none"> <li>1. <b>Mixture</b> too rich</li> <li>2. <b>Idling RPM</b> too high</li> <li>3. <b>Gasoline</b> incorrect</li> <li>4. <b>Air cleaner element</b> dirty</li> <li>5. <b>Spark plug</b> incorrect (too cold)</li> <li>6. <b>Valve seals</b> cracked - missing</li> <li>7. <b>Oil rings</b> worn - broken</li> </ol>	<ol style="list-style-type: none"> <li>1. Adjust carburetor</li> <li>2. Adjust carburetor</li> <li>3. Change to correct gasoline</li> <li>4. Clean element</li> <li>5. Replace plug</li> <li>6. Replace seals</li> <li>7. Replace rings</li> </ol>
Problem: Spark plug electrodes overheat or burn	
Condition	Remedy
<ol style="list-style-type: none"> <li>1. <b>Spark plug</b> incorrect (too hot)</li> <li>2. <b>Engine</b> overheats</li> <li>3. <b>Spark plug</b> loose</li> <li>4. <b>Mixture</b> too lean</li> </ol>	<ol style="list-style-type: none"> <li>1. Replace plug</li> <li>2. Service cooling system</li> <li>3. Tighten plug</li> <li>4. Adjust carburetor</li> </ol>
Problem: Battery does not charge	
Condition	Remedy
<ol style="list-style-type: none"> <li>1. <b>Lead wires/connections</b> shorted - loose - open</li> <li>2. <b>Magneto coils</b> shorted - grounded - open</li> <li>3. <b>Regulator/rectifier</b> shorted - punctured</li> </ol>	<ol style="list-style-type: none"> <li>1. Repair - replace - tighten lead wires</li> <li>2. Replace magneto coils</li> <li>3. Replace regulator/rectifier</li> </ol>
Problem: Battery charges, but charging rate is below the specification	
Condition	Remedy
<ol style="list-style-type: none"> <li>1. <b>Lead wires</b> shorted - open - loose (at terminals)</li> <li>2. <b>Stator coils (magneto)</b> grounded - open</li> <li>3. <b>Regulator/rectifier</b> defective</li> <li>4. <b>Electrolyte</b> low</li> <li>5. <b>Cell plates (battery)</b> defective</li> </ol>	<ol style="list-style-type: none"> <li>1. Repair - tighten lead wires</li> <li>2. Replace stator coils</li> <li>3. Replace regulator/rectifier</li> <li>4. Add distilled water</li> <li>5. Replace battery</li> </ol>

<b>Problem: Magneto overcharges</b>	
<b>Condition</b>	<b>Remedy</b>
<ol style="list-style-type: none"> <li>1. <b>Internal battery</b> short circuited</li> <li>2. <b>Regulator/rectifier resistor</b> damaged - defective</li> <li>3. <b>Regulator/rectifier</b> poorly grounded</li> </ol>	<ol style="list-style-type: none"> <li>1. Replace battery</li> <li>2. Replace resistor</li> <li>3. Clean - tighten ground connection</li> </ol>
<b>Problem: Charging unstable</b>	
<b>Condition</b>	<b>Remedy</b>
<ol style="list-style-type: none"> <li>1. <b>Lead wire</b> intermittently shorting</li> <li>2. <b>Magneto</b> internally shorted</li> <li>3. <b>Regulator/rectifier</b> defective</li> </ol>	<ol style="list-style-type: none"> <li>1. Replace lead wire</li> <li>2. Replace magneto</li> <li>3. Replace regulator/rectifier</li> </ol>
<b>Problem: Starter button not effective</b>	
<b>Condition</b>	<b>Remedy</b>
<ol style="list-style-type: none"> <li>1. <b>Battery charge</b> low</li> <li>2. <b>Switch contacts</b> defective</li> <li>3. <b>Starter motor brushes</b> not seating</li> <li>4. <b>Starter relay</b> defective</li> <li>5. <b>Emergency stop - ignition switch</b> off</li> <li>6. <b>Wiring connections</b> loose - disconnected</li> </ol>	<ol style="list-style-type: none"> <li>1. Recharge - replace battery</li> <li>2. Replace switch</li> <li>3. Repair - replace brushes</li> <li>4. Replace relay</li> <li>5. Turn on switches</li> <li>6. Connect - tighten - repair connections</li> </ol>
<b>Problem: Battery "sulfation" (Acidic white powdery substance or spots on surfaces of cell plates)</b>	
<b>Condition</b>	<b>Remedy</b>
<ol style="list-style-type: none"> <li>1. <b>Charging rate</b> too low - too high</li> <li>2. <b>Battery electrolyte</b> excessive - insufficient</li> <li>3. <b>Specific gravity</b> too high - too low</li> <li>4. <b>Battery</b> run-down - damaged</li> <li>5. <b>Electrolyte</b> contaminated</li> </ol>	<ol style="list-style-type: none"> <li>1. Replace battery</li> <li>2. Keep electrolyte to prescribed level</li> <li>3. Charge battery - add distilled water</li> <li>4. Replace battery</li> <li>5. Replace battery</li> </ol>
<b>Problem: Battery discharges too rapidly</b>	
<b>Condition</b>	<b>Remedy</b>
<ol style="list-style-type: none"> <li>1. <b>Electrolyte</b> contaminated</li> <li>2. <b>Specific gravity</b> too high</li> <li>3. <b>Charging system (charging operation)</b> not set properly</li> <li>4. <b>Cell plates</b> overcharged - damaged</li> <li>5. <b>Battery</b> short-circuited</li> <li>6. <b>Specific gravity</b> too low</li> </ol>	<ol style="list-style-type: none"> <li>1. Replace battery</li> <li>2. Charge battery - add distilled water</li> <li>3. Check magneto - regulator/rectifier - circuit connections - adjust for specified charging operation</li> <li>4. Replace battery - correct charging system</li> <li>5. Replace battery</li> <li>6. Recharge battery</li> </ol>
<b>Problem: Battery polarity reversed</b>	
<b>Condition</b>	<b>Remedy</b>
<ol style="list-style-type: none"> <li>1. <b>Battery</b> incorrectly connected</li> </ol>	<ol style="list-style-type: none"> <li>1. Reverse connections - replace battery</li> </ol>



## Steering/Suspension

Problem: Handling too heavy or stiff	
Condition	Remedy
<ol style="list-style-type: none"> <li>1. <b>Front wheel alignment</b> incorrect</li> <li>2. <b>Lubrication</b> inadequate</li> <li>3. <b>Tire inflation pressure</b> incorrect</li> <li>4. <b>Tie rod ends</b> seizing</li> <li>5. <b>Linkage connections</b> seizing</li> </ol>	<ol style="list-style-type: none"> <li>1. Adjust alignment</li> <li>2. Lubricate appropriate components</li> <li>3. Adjust pressure</li> <li>4. Replace tie rod ends</li> <li>5. Repair - replace connections</li> </ol>
Problem: Steering oscillation	
Condition	Remedy
<ol style="list-style-type: none"> <li>1. <b>Tires</b> inflated unequally</li> <li>2. <b>Wheel(s)</b> wobbly</li> <li>3. <b>Wheel hub cap screw(s)</b> loose - missing</li> <li>4. <b>Wheel hub bearing</b> worn - damaged</li> <li>5. <b>Tie rod ends</b> worn - loose</li> <li>6. <b>Tires</b> defective - incorrect</li> <li>7. <b>A-arm bushings</b> damaged</li> <li>8. <b>Bolts - nuts (frame)</b> loose</li> </ol>	<ol style="list-style-type: none"> <li>1. Adjust pressure</li> <li>2. Replace wheel(s)</li> <li>3. Tighten - replace cap screws</li> <li>4. Replace bearing</li> <li>5. Replace - tighten tie rod ends</li> <li>6. Replace tires</li> <li>7. Replace bushings</li> <li>8. Tighten bolts - nuts</li> </ol>
Problem: Steering pulling to one side	
Condition	Remedy
<ol style="list-style-type: none"> <li>1. <b>Tires</b> inflated unequally</li> <li>2. <b>Front wheel alignment</b> incorrect</li> <li>3. <b>Wheel hub bearings</b> worn - broken</li> <li>4. <b>Frame</b> distorted</li> <li>5. <b>Shock absorber</b> defective</li> </ol>	<ol style="list-style-type: none"> <li>1. Adjust pressure</li> <li>2. Adjust alignment</li> <li>3. Replace bearings</li> <li>4. Repair - replace frame</li> <li>5. Replace shock absorber</li> </ol>
Problem: Steering impaired	
Condition	Remedy
<ol style="list-style-type: none"> <li>1. <b>Tire pressure</b> too high</li> <li>2. <b>Steering linkage connections</b> worn</li> <li>3. <b>Cap screws (suspension system)</b> loose</li> </ol>	<ol style="list-style-type: none"> <li>1. Adjust pressure</li> <li>2. Replace connections</li> <li>3. Tighten cap screws</li> </ol>
Problem: Tire wear rapid or uneven	
Condition	Remedy
<ol style="list-style-type: none"> <li>1. <b>Wheel hub bearings</b> worn - loose</li> <li>2. <b>Front wheel alignment</b> incorrect</li> </ol>	<ol style="list-style-type: none"> <li>1. Replace bearings</li> <li>2. Adjust alignment</li> </ol>
Problem: Steering noise	
Condition	Remedy
<ol style="list-style-type: none"> <li>1. <b>Caps screws - nuts</b> loose</li> <li>2. <b>Wheel hub bearings</b> broken - damaged</li> <li>3. <b>Lubrication</b> inadequate</li> </ol>	<ol style="list-style-type: none"> <li>1. Tighten cap screws - nuts</li> <li>2. Replace bearings</li> <li>3. Lubricate appropriate components</li> </ol>

<b>Problem: Suspension too soft</b>	
<b>Condition</b>	<b>Remedy</b>
1. <b>Spring(s)</b> weak 2. <b>Shock absorber</b> damaged	1. Replace spring(s) 2. Replace shock absorber
<b>Problem: Suspension too stiff</b>	
<b>Condition</b>	<b>Remedy</b>
1. <b>A-arm-related bushings</b> worn	1. Replace bushing
<b>Problem: Suspension noisy</b>	
<b>Condition</b>	<b>Remedy</b>
1. <b>Cap screws (suspension system)</b> loose 2. <b>A-arm-related bushings</b> worn	1. Tighten cap screws 2. Replace bushings
<b>Problem: Rear wheel oscillation</b>	
<b>Condition</b>	<b>Remedy</b>
1. <b>Rear wheel hub bearings</b> worn - loose 2. <b>Tires</b> defective - incorrect 3. <b>Wheel rim</b> distorted 4. <b>Wheel hub cap screws</b> loose 5. <b>Parking brake</b> adjusted incorrectly 6. <b>Rear suspension arm-related bushing</b> worn 7. <b>Rear shock absorber</b> damaged 8. <b>Rear suspension arm nut</b> loose	1. Replace bearings 2. Replace tires 3. Replace rim 4. Tighten cap screws 5. Adjust parking brake 6. Replace bushing 7. Replace shock absorber 8. Tighten nut

---

## Brakes

---

<b>Problem: Braking poor</b>	
<b>Condition</b>	<b>Remedy</b>
1. <b>Pad</b> worn 2. <b>Pedal free-play</b> excessive 3. <b>Brake fluid</b> leaking 4. <b>Hydraulic system</b> leaking air 5. <b>Master cylinder/brake cylinder seal</b> worn	1. Replace pads 2. Adjust free-play 3. Repair - replace hydraulic system 4. Bleed hydraulic system 5. Replace seal(s)
<b>Problem: Brake pedal travel excessive</b>	
<b>Condition</b>	<b>Remedy</b>
1. <b>Hydraulic system</b> entrapped air 2. <b>Brake fluid</b> low 3. <b>Brake fluid</b> incorrect 4. <b>Piston seal - cup</b> worn	1. Bleed hydraulic system 2. Add fluid to proper level 3. Replace with correct fluid 4. Replace seal - cup
<b>Problem: Brake fluid leaking</b>	
<b>Condition</b>	<b>Remedy</b>
1. <b>Connection joints</b> loose 2. <b>Hose</b> cracked 3. <b>Piston seal</b> worn	1. Tighten joint 2. Replace hose 3. Replace seal